



GASTROPARTS

Küppersbusch

- [EN]** Equipment
- [DE]** Geräte
- [ES]** Aparatos
- [FR]** Équipement
- [IT]** Attrezzature
- [PL]** Urządzenia
- [RU]** Оборудование

✉ gastroparts@gastroparts.com

☎ +48 56 657 00 66

📘 fb.com/gastroparts.global

GASTROPARTS.COM





heating elements

heating elements for ovens



1

Part No.	416915	Ref. No.	182323
description	heating element 1500W 230V heating circuits 1 L 460mm W 484mm L1 107mm W2 62mm flange length 104mm flange width 32mm tilt flange oven		
For models:	LEH405, LEH503, LEH505, LEH605, LEH703, LEH705, LGH405, LGH605		

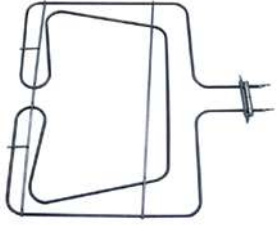

1

Part No.	415995	Ref. No.	182322
description	heating element 1500W 400V heating circuits 1 L 460mm W 484mm L1 107mm L2 360mm W1 211mm W2 62mm flange length 104mm flange width 32mm hole distance 96/39mm hole ø 4mm tube ø 6.4mm connection male faston 6.3mm connection length 51mm tilt flange dry heating element		
For models:	EEH413, EEH503, EEH613, EEH703, EGH413, EGH613, LEH405, LEH503, LEH505, LEH605, LEH703, LEH705, LGH405, LGH605		



1

Part No.	416916	Ref. No.	182326
description	heating element 2000W 230V heating circuits 1 L 490mm W 575mm L1 40mm L2 450mm W1 257mm W2 60mm flange length 105mm flange width 34mm tube ø 6.5mm tilt flange oven		
For models:	NEH413, NEH415, NEH505, NEH613, NEH615, NEH705, NGH403, NGH405, NGH503, NGH505, NGH603, NGH605, NGH723, NGH725		



1

Part No.	415795	Ref. No.	182325
description	heating element 2000W 400V heating circuits 1 L 490mm W 575mm L1 40mm L2 450mm W1 257mm W2 60mm flange length 105mm flange width 34mm hole distance 38mm hole ø 4mm tube ø 6.5mm connection male faston 6.3mm tilt flange dry heating element oven		
For models:	FEH413, FEH415, FEH503, FEH505, FEH513, FEH515, FEH613, FEH615, FEH705, FEH715, FGH413, FGH415, FGH613, FGH615, NEH413, NEH415, NEH505, NEH613, NEH615, NEH705, NGH403, NGH405, NGH413, NGH415, NGH503, NGH505, NGH603, NGH605, NGH613, NGH615, NGH723, NGH725, NGH733		

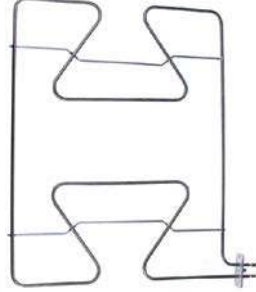

1

Part No.	418223	Ref. No.	540471
description	heating element 2000W 400V L 490mm W 560mm L1 25mm L2 465mm W1 530mm W2 30mm flange length 70mm flange width 22mm hole distance 56mm hole ø M4mm tube ø 6.3mm connection length 41mm connection male faston 6.3mm heating circuits 1 rectangular flange dry heating element oven		

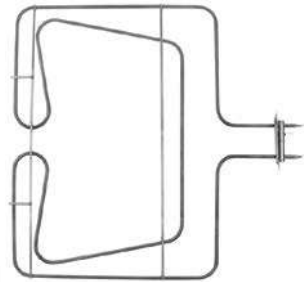

1

Part No.	417605	Ref. No.	160631
description	heating element 2100W 400V L 465mm W 480mm H 10mm tube ø 6.5mm heating circuits 1 oven		

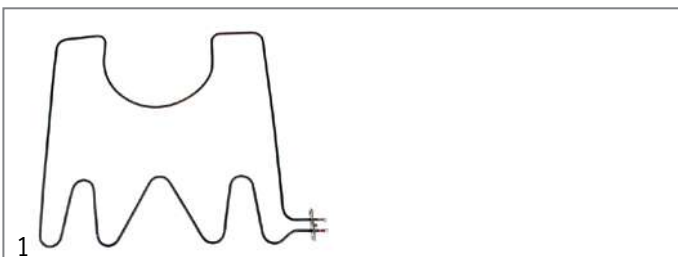





Part No.	418364	Ref. No.	182474 182478
description	heating element 2250W 380V L 598mm W 553mm L1 55mm L2 543mm W1 488mm W2 30mm flange length 70mm flange width 22mm hole distance 56mm hole ø 6mm tube ø 6.5mm connection length 34mm connection male faston 6.3mm heating circuits 1 rectangular flange dry heating element		
For models:	EGN401, EHN401, EHN601, EHN801		



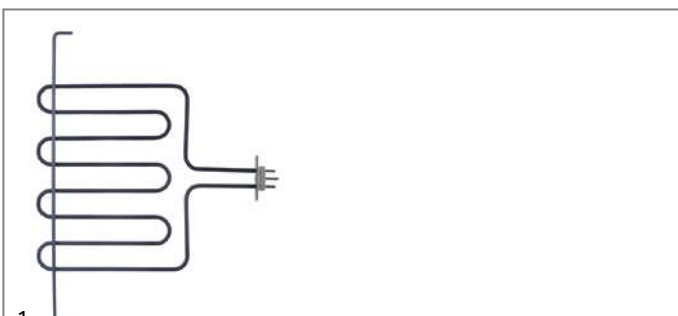



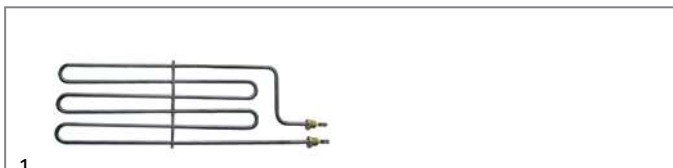

Part No.	550405	Ref. No.	184583
description	power socket male faston 6.3mm for heating element 2-pole + earthing		
For models:	ECL484		

heating elements for bain maries



Part No.	418359	Ref. No.	160106 181738 182665	
description	heating element 2500W 230V L 338mm W 288mm L1 104mm L2 234mm W1 135mm W2 32mm bridge length 450mm windings 4 connection plug-in connection heating circuits 1 tube ø 6.3mm rectangular flange dry heating element hole distance 55mm flange length 72mm flange width 22mm hole ø 3mm			
For models:	ECL484			
accessories for	418359			
	Part No.	550404	Ref. No.	—
	Part No.	550405	Ref. No.	184583



Part No.	415608	Ref. No.	182403	
description	heating element 2000W 230V heating circuits 1 L 430mm W 135mm connection length 20mm connection male faston 6.3mm tube ø 6.3mm 2 hole fixing thread M14x1.5 dry heating element L1 50mm L2 380mm W1 100mm W2 38mm mounting distance 32mm			
For models:	EWB201, EWB201-mit-Thermostat, EWN201, EWN401, EWN401-mit-beheizterm-Schrankraum, EWN402, EWP202, SEW250, SEW400, SEW450			
spare parts for	415608			
	Part No.	510417	Ref. No.	—
accessories for	415608			
	Part No.	520228	Ref. No.	40156998
	Part No.	520230	Ref. No.	407298
	Part No.	521101	Ref. No.	—
	Part No.	550262	Ref. No.	—

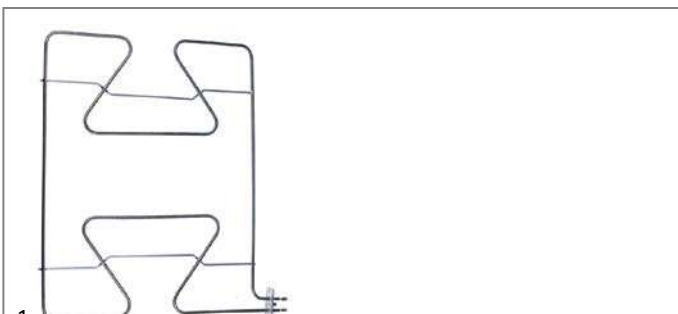





Part No.	418222	Ref. No.	540831
description	heating element 2800W 400V L 500mm W 560mm L1 50mm L2 450mm W1 530mm W2 30mm flange length 70mm flange width 22mm hole distance 56mm tube ø 6.3mm dry heating element oven		



Part No.	416936	Ref. No.	540635
description	heating element 2000W 230V heating circuits 1 L 470mm W 246mm connection male faston 6.3mm connection distance 240mm tube ø 6.5mm dry heating element bain marie		
For models:	EEW250, EEW450, EEW452		





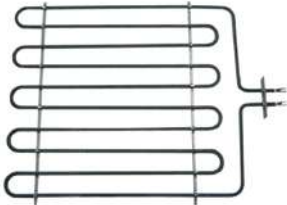

1

Part No.	415609	Ref. No.	182404
description	heating element 2000W 400V heating circuits 1 L 430mm W 135mm connection male faston 6.3mm tube ø 6.5mm 2 hole fixing thread M14x1.5 immersion heater L1 50mm L2 380mm W1 100mm W2 38mm mounting distance 32mm		
For models:	EWB201, EWB201-mit-Thermostat, EWN201, EWN401, EWN401-mit-beheizterm-Schrankraum, EWN402, SEW400, SEW450		
accessories for	415609		
	Part No.	510417	Ref. No. —
	flat gasket fibre ED ø 20mm ID ø 14mm thickness 2mm Qty 1 pcs		
	Part No.	520228	Ref. No. 40156998
	tooth lock washer ID ø 15.3mm ED ø 24mm steel Qty 1 pcs for thread M14		
	Part No.	520230	Ref. No. 407298
	nut thread M14x1.5 H 5mm WS 19 zinc-coated steel Qty 1 pcs		
	Part No.	521101	Ref. No. —
	nut thread M14x1.5 H 5mm WS 19 SS Qty 1 pcs		
	Part No.	550262	Ref. No. —
	flat gasket copper ED ø 20mm ID ø 14mm thickness 2mm		



1

Part No.	415988	Ref. No.	182328
description	heating element 3000W 230V heating circuits 1 L 420mm W 330mm L1 36mm L2 383mm W1 147mm W2 30mm flange length 70mm flange width 23mm hole distance 56mm connection male faston 6.3mm tube ø 6.5mm rectangular flange mounting thread M3 dry heating element		
For models:	LEW450, LEW452, NEW180, NEW182, NEW250, NEW252, NEW450, NEW452, PEW658		
accessories for	415988		
	Part No.	527169	Ref. No. —
	hexagonal nut thread M3 H 2.8mm WS 5.5 brass Qty 1 pcs		
	Part No.	560110	Ref. No. —
	plain washer ID ø 3.2mm ED ø 7mm thickness 0.5mm SS Qty 20 pcs DIN 125A for thread M3		
	Part No.	560130	Ref. No. —
	hexagonal nut thread M3 H 2.4mm WS 5.5 SS DIN/ISO DIN 934 / ISO 4032/8673 Qty 20 pcs		

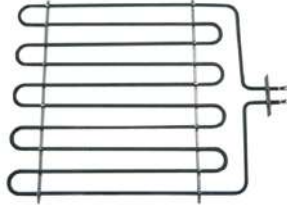

1

Part No.	415589	Ref. No.	182327
description	heating element 3000W 400V heating circuits 1 L 420mm W 330mm flange length 70mm flange width 22mm hole distance 57mm connection male faston 6.3mm tube ø 6.3mm flange 70 x 22mm dry heating element L1 41mm L2 383mm W1 149mm W2 31mm		
For models:	FEW250, FEW252, LEW450, LEW452, NEW250, NEW252, NEW450, NEW452, PEW458		



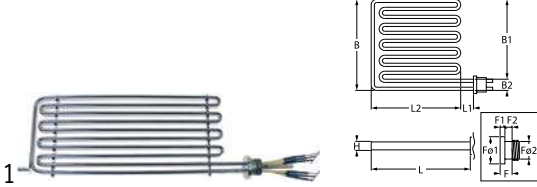

heating elements for fryers

side connection





with thread





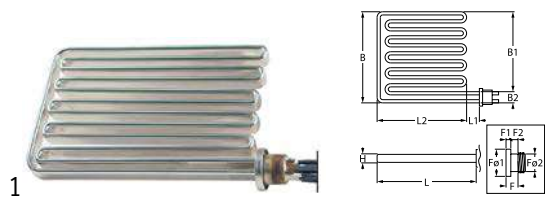

1

Part No.	416906	Ref. No.	540618
description	heating element 7000W 230/400V heating circuits 3 mounting pos. left L 458mm W 178mm H 22mm flange length 20mm flange length 1 9.8mm flange length 2 9.7mm flange ø1 51mm flange ø2 36mm thermostat sleeves ø 5.5mm length thermostat sleeves 180/270mm number of thermostat sleeves 2 L1 43mm L2 415mm W1 155mm W2 23mm thread M36x1.5 windings 4 cable length 650mm rotation flange immersion heater for fryer/pasta cooker connection length 75mm		
For models:	EEW400		
accessories for	416906		
	Part No.	521004	Ref. No. 540540
	hexagonal nut thread M36x1.5 WS 46 H 14mm brass		
	Part No.	550673	Ref. No. 540538
	flat gasket PTFE D1 ø 46mm D2 ø 36/38.2mm thickness 5mm Qty 1 pcs mounting pos. outer		
	Part No.	550674	Ref. No. 540537
	flat gasket PTFE ED ø 46mm ID ø 36mm thickness 4mm Qty 1 pcs mounting pos. inner		
	Part No.	692060	Ref. No. —
	retaining ring brass H 10mm ID ø 36mm ED ø 50mm		

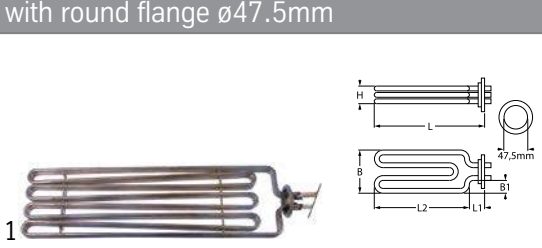

			
Part No.	416910	Ref. No.	540558
description	heating element 8000W 230/400V heating circuits 3 L 300mm W 185mm H 22mm flange length 20mm flange length 1 9mm flange length 2 11mm flange ø1 51mm flange ø2 36mm thermostat sleeves ø 4mm length thermostat sleeves 280/300mm number of thermostat sleeves 2 L1 15mm L2 285mm W1 162mm W2 23mm thread M36x1.5 windings 5 cable length 650mm rotation flange immersion heater pasta cooker		
For models:	EEF124, EEF224		
accessories for	416910		
	Part No.	521004	Ref. No. 540540
	hexagonal nut thread M36x1.5 WS 46 H 14mm brass		
	Part No.	550673	Ref. No. 540538
	flat gasket PTFE D1 ø 46mm D2 ø 36/38.2mm thickness 5mm Qty 1 pcs mounting pos. outer		
	Part No.	550674	Ref. No. 540537
	flat gasket PTFE ED ø 46mm ID ø 36mm thickness 4mm Qty 1 pcs mounting pos. inner		
	Part No.	692060	Ref. No. —
	retaining ring brass H 10mm ID ø 36mm ED ø 50mm		

with round flange ø47.5mm			
			
Part No.	416941	Ref. No.	181734 182338
description	heating element 9900W 230/400V mounting ø 47.5mm heating circuits 3 L 510mm W 138mm H 23mm L1 21mm L2 489mm W1 51mm W2 36mm round flange connection cable cable length 160mm immersion heater tube ø 6.3mm connection length 55mm		
For models:	FEF170, FEF180, NEF176, PEF178, PEF188		
accessories for	416941		
	Part No.	510408	Ref. No. 060842
	O-ring EPDM thickness 5.34mm ID ø 47mm Qty 1 pcs		
	Part No.	510562	Ref. No. —
	O-ring silicone thickness 5.34mm ID ø 47mm Qty 1 pcs		
	Part No.	550002	Ref. No. 144280
	tension strap H 10mm L 21mm W 10mm hole ø 6.5mm for heating element		
	Part No.	550675	Ref. No. 060840
	O-ring Viton thickness 6mm ID ø 47mm Qty 1 pcs		

miscellaneous

			
Part No.	418372	Ref. No.	182398
description	heating element 9000W 230/400V		
For models:	NEF144		

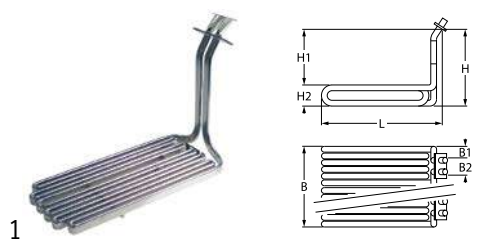
			
Part No.	418263	Ref. No.	540441
description	heating element 7200W 230/400V heating circuits 3 L 360mm W 150mm H 220mm L1 25mm L2 335mm W1 58mm W2 42mm flange length 75mm flange width 30mm hole distance 63mm hole ø 5.5mm rectangular flange immersion heater		

2 hole fixing





			
Part No.	415591	Ref. No.	182651
description	heating element 2000W 230V heating circuits 1 L 285mm W 40mm H 240mm H1 200mm H2 40mm mounting pos. 20 thread M14x1.5 tube ø 8.5mm mounting distance 20mm windings 3 2 hole fixing connection male faston 6.3mm immersion heater		
For models:	LEF124, LEF224, NEF124, NEF224, SEF124, SEF224, TEF124, TEF224		
spare parts for	415591		
	Part No.	510417	Ref. No. —
	flat gasket fibre ED ø 20mm ID ø 14mm thickness 2mm Qty 1 pcs		
accessories for	415591		
	Part No.	520228	Ref. No. 40156998
	tooth lock washer ID ø 15.3mm ED ø 24mm steel Qty 1 pcs for thread M14		
	Part No.	520230	Ref. No. 407298
	nut thread M14x1.5 H 5mm WS 19 zinc-coated steel Qty 1 pcs		
	Part No.	521101	Ref. No. —
	nut thread M14x1.5 H 5mm WS 19 SS Qty 1 pcs		

Table continues overleaf

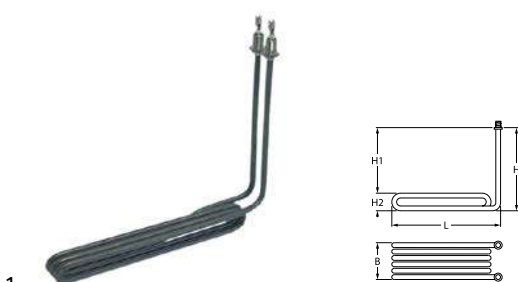

accessories for	415591			
	Part No.	550262	Ref. No.	—
	flat gasket copper ED ø 20mm ID ø 14mm thickness 2mm			



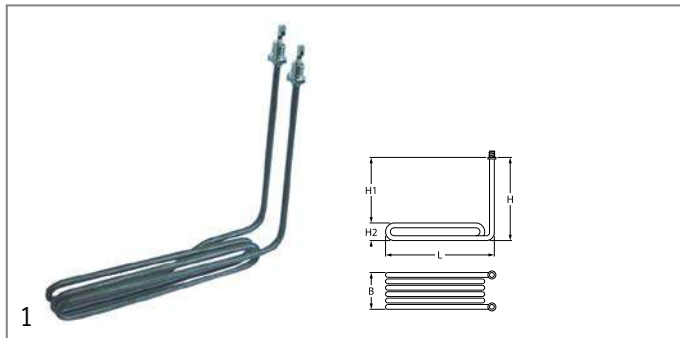

Part No.	415978	Ref. No.	182652
description	heating element 3000W 230V heating circuits 1 L 288mm W 48mm H 243mm H1 205mm H2 38mm thread M14x1.5 tube ø 8.5mm windings 3 2 hole fixing connection male faston 6.3mm		
For models:	FEF124, FEF144, FEF144e, FEF224, FEF224e, LEF124, LEF224, NEF124, NEF144, NEF224, NEF244, PEF128, PEF148, PEF228, SEF124, SEF144, SEF224, TEF124, TEF144, TEF224		

spare parts for	415978			
	Part No.	510417	Ref. No.	—
	flat gasket fibre ED ø 20mm ID ø 14mm thickness 2mm Qty 1 pcs			

accessories for	415978			
	Part No.	510417	Ref. No.	—
	flat gasket fibre ED ø 20mm ID ø 14mm thickness 2mm Qty 1 pcs			

	Part No.	520228	Ref. No.	40156998
	tooth lock washer ID ø 15.3mm ED ø 24mm steel Qty 1 pcs for thread M14			

	Part No.	520230	Ref. No.	407298
	nut thread M14x1.5 H 5mm WS 19 zinc-coated steel Qty 1 pcs			

	Part No.	521101	Ref. No.	—
	nut thread M14x1.5 H 5mm WS 19 SS Qty 1 pcs			

	Part No.	550262	Ref. No.	—
	flat gasket copper ED ø 20mm ID ø 14mm thickness 2mm			

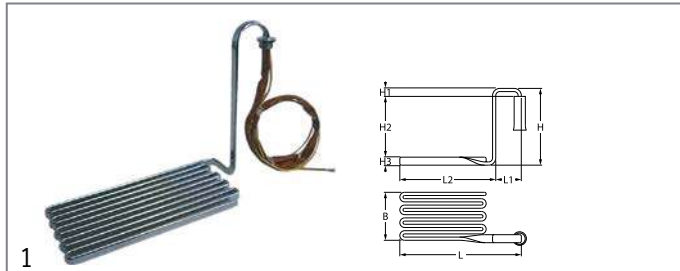

Part No.	415613	Ref. No.	540401
description	heating element 8000W 380V heating circuits 3 L 423mm W 145mm H 308mm L1 65mm L2 358mm W1 65mm W2 17mm H1 33mm H2 258mm H3 17mm thread M26x1.5 cable length 1200mm immersion heater		

heating elements for griddles



Part No.	418238	Ref. No.	540458
description	heating element 2000W 400V heating circuits 1 L 494mm W 96mm H 29mm tube ø 6.3mm rectangular flange connection male faston 6.3mm hole distance 36mm flange length 45mm flange width 16mm connection length 28mm mounting thread M4 dry heating element		



Part No.	415824	Ref. No.	182356
description	heating element 2000W 400V heating circuits 1 L 533mm W 92mm Hmm tube ø 6.3mm L1 50mm L2 483mm W1 68mm W2 24mm rectangular flange connection cable hole distance 36mm cable length 365mm flange length 45mm flange width 16mm mounting thread M4 dry heating element		



Part No.	415593	Ref. No.	160104 182330
description	heating element 2565W 230V L 554mm W 125mm H 30mm connection male faston 6.3mm dry heating element heating circuits 1 tube ø 8.5mm W1 40mm W2 45mm rectangular flange hole distance 56mm flange length 70mm flange width 22mm hole ø 5mm connection length 34mm		
For models:	NEB430, NEB630, NEG420, NEP600, NEP900		



Part No.	415594	Ref. No.	182329
description	heating element 2565W 400V L 556mm W 126mm H 33mm connection male faston 6.3mm dry heating element heating circuits 1 tube ø 6.3mm W1 48mm W2 30mm rectangular flange hole distance 56mm flange length 70mm flange width 22mm mounting thread M4		
For models:	NEB430, NEB630, NEG420, NEP600, NEP900		

heating elements for tilting bratt pan





Part No.	415964	Ref. No.	181733 182344
description	heating element 2350W 230V L 510mm W 130mm H 30mm connection male faston dry heating element heating circuits 1 tube ø 6.3mm W1 50mm W2 30mm rectangular flange hole distance 56mm flange length 70mm flange width 22mm hole ø 5mm connection length 18mm		
For models:	NEP203, NEP303		



			
Part No.	415593	Ref. No.	160104 182330
description	heating element 2565W 230V L 554mm W 125mm H 30mm connection male faston 6.3mm dry heating element heating circuits 1 tube ø 8.5mm W1 40mm W2 45mm rectangular flange hole distance 56mm flange length 70mm flange width 22mm hole ø 5mm connection length 34mm		
For models:	NEB430, NEB630, NEG420, NEP600, NEP900		

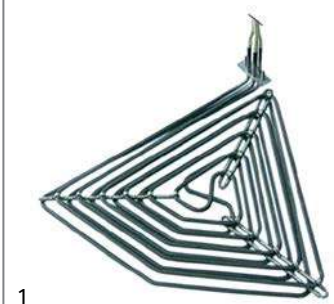



			
Part No.	415594	Ref. No.	182329
description	heating element 2565W 400V L 556mm W 126mm H 33mm connection male faston 6.3mm dry heating element heating circuits 1 tube ø 6.3mm W1 48mm W2 30mm rectangular flange hole distance 56mm flange length 70mm flange width 22mm mounting thread M4		
For models:	NEB430, NEB630, NEG420, NEP600, NEP900		

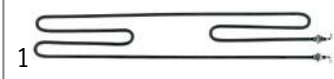

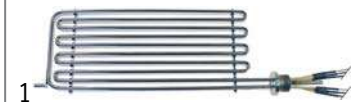

			
Part No.	415314	Ref. No.	181730 182519 182730
description	heating element 5500W 230V L 375mm W 380mm H 35mm connection cable dry heating element heating circuits 2 tube ø 6.5mm rectangular flange hole distance 41mm flange length 60mm flange width 25mm mounting thread M5		

			
Part No.	418365	Ref. No.	182458
description	heating element griddle 2000W 230V L 444mm W 127mm H 20mm connection male faston 6.3mm dry heating element tube ø 6.3mm W1 95mm W2 34mm 2 hole fixing thread M14x1.5 mounting distance 28mm		
For models:	EGP202		

			
Part No.	416944	Ref. No.	160114 160120
description	heating element pressure kettle 1800W 235V L 565mm W 85mm H 85mm connection male faston dry heating element heating circuits 1 tube ø 6.3mm W1 57mm W2 28mm 2 hole fixing thread 1/8" mounting distance 22mm		
For models:	FEP230, FEP330, FEP600, FEP610, FEP900, FEP910, PEP238, PEP338, PEP608, PEP618, PEP908, PEP918		

heating elements for pasta cookers

			
Part No.	416906	Ref. No.	540618
description	heating element 7000W 230/400V heating circuits 3 mounting pos. left L 458mm W 178mm H 22mm flange length 20mm flange length 1 9.8mm flange length 2 9.7mm flange ø1 51mm flange ø2 36mm thermostat sleeves ø 5.5mm length thermostat sleeves 180/270mm number of thermostat sleeves 2 L1 43mm L2 415mm W1 155mm W2 23mm thread M36x1.5 windings 4 cable length 650mm rotation flange immersion heater for fryer/pasta cooker connection length 75mm		
For models:	EEW400		
accessories for	416906		
	Part No.	521004	Ref. No. 540540
	hexagonal nut thread M36x1.5 WS 46 H 14mm brass		
	Part No.	550673	Ref. No. 540538
	flat gasket PTFE D1 ø 46mm D2 ø 36/38.2mm thickness 5mm Qty 1 pcs mounting pos. outer		
	Part No.	550674	Ref. No. 540537
	flat gasket PTFE ED ø 46mm ID ø 36mm thickness 4mm Qty 1 pcs mounting pos. inner		
	Part No.	692060	Ref. No. —
	retaining ring brass H 10mm ID ø 36mm ED ø 50mm		

			
Part No.	416910	Ref. No.	540558
description	heating element 8000W 230/400V heating circuits 3 L 300mm W 185mm H 22mm flange length 20mm flange length 1 9mm flange length 2 11mm flange ø1 51mm flange ø2 36mm thermostat sleeves ø 4mm length thermostat sleeves 280/300mm number of thermostat sleeves 2 L1 15mm L2 285mm W1 162mm W2 23mm thread M36x1.5 windings 5 cable length 650mm rotation flange immersion heater pasta cooker		
For models:	EEF124, EEF224		
accessories for	416910		
	Part No.	521004	Ref. No. 540540
	hexagonal nut thread M36x1.5 WS 46 H 14mm brass		
	Part No.	550673	Ref. No. 540538
	flat gasket PTFE D1 ø 46mm D2 ø 36/38.2mm thickness 5mm Qty 1 pcs mounting pos. outer		
	Part No.	550674	Ref. No. 540537
	flat gasket PTFE ED ø 46mm ID ø 36mm thickness 4mm Qty 1 pcs mounting pos. inner		
	Part No.	692060	Ref. No. —
	retaining ring brass H 10mm ID ø 36mm ED ø 50mm		



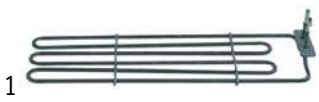

heating elements for chagrills

			
Part No.	415595	Ref. No.	182332
description	heating element 1900W 400V L 410mm W 125mm H 28mm hole distance 56mm windings 3 W1 45mm W2 31mm flange length 70mm flange width 22mm connection male faston 6.3mm heating circuits 1 tube ø 6.3mm mounting thread M4 rectangular flange dry heating element		
For models:	LEB270, LEB430, LEG420, LEP400, NEP400, SEB230, SEB430, SEB630, SEG220, SEG420, SEG620, SES400		



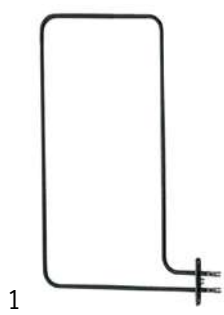

			
Part No.	415592	Ref. No.	182653
description	heating element 2000W 230V L 400mm W 142mm H 64mm thread M14x1.5 mounting distance 94mm tube ø 8.5mm connection male faston 6.3mm windings 3 heating circuits 1 connection length 39mm 2 hole fixing dry heating element W1 21mm W2 102mm		
For models:	SER400, SER600		

heating elements for heated cabinets

			
Part No.	416919	Ref. No.	182475
description	heating element 500W 230V heating circuits 1 L 405mm W 260mm flange length 70mm flange width 22mm hole distance 56mm connection male faston 6.3mm tube ø 6.3mm rectangular flange hole ø 5mm dry heating element L1 375mm L2 30mm W1 53mm W2 207mm		
For models:	EHN601, EHP601, EWN401-mit-beheizterm-Schrankraum, LEH605, LEH703, LEH705, LGH605, LGH607, NEA182, NEH613, NEH705, NGH603, NGH723		

			
Part No.	415970	Ref. No.	182476
description	heating element 650W 400V heating circuits 1 L 405mm W 260mm flange length 70mm flange width 22mm hole distance 56mm connection male faston 6.3mm tube ø 6.3mm rectangular flange hole ø 5mm L1 375mm L2 30mm W1 53mm W2 207mm		
For models:	EHN601, EWN401-mit-beheizterm-Schrankraum, LEH605, LEH703, LEH705, LEW452, LGH605, NEH613, NEH705, NGH603, NGH613, NGH723, NGH733		
accessories for	415970		
	Part No.	510368	Ref. No. —
	gasket L 70mm W 23.5mm hole ø 5mm hole distance 56mm FIBER thickness 2mm for heating element		

bottom heaters

			
Part No.	415760	Ref. No.	540463
description	bottom heater 1800W 230V heating circuits 1 ø 196mm safety thermostat°C thermostat 128°C M5 mounting distance 180mm		
spare parts for	415760		
	Part No.	375300	Ref. No. —
	thermostat t.max. 128°C temperature range 35-128°C 1-pole 1NO 16A probe ø 3.1mm probe L 174mm capillary pipe 880mm capillary pipe isolated 800mm gland nut shaft L 23mm shaft position lower rotation 270°		
accessories for	415760		
	Part No.	520323	Ref. No. —
	gasket ID ø 160mm ED ø 200mm hole distance 90/180mm hole ø 7mm silicone for bottom heaters		
	Part No.	520324	Ref. No. —
	counterflange ID ø 160mm ED ø 200mm hole distance 90/180mm hole ø 7mm SS for bottom heaters		







heaters





			
1			
Part No.	418604	Ref. No.	948746006
description	heater 5400W 230V heating circuits 3 L 650mm W 325mm H 70mm connection cable cable length 250mm		

heater battery

			
1			
Part No.	415122	Ref. No.	402628
description	heater battery mounting distance 185mm W 40mm H 35mm 2000W 230V temperature restriction 105°C heating circuits 2 connection cable cable length 340mm L 197mm for cross flow fan		
For models:	FEH613, FEH615, FEH705, FEH715, FEW252, FGH613, FGH615, FGH617, NEA182, NEH212, NEH615, NEH705, NEW182, NEW252, NEW452, NGH202, NGH605, NGH607, NGH615, NGH617, NGH725, NGH727, NGH737		







pilot heating elements

			
1			
Part No.	415607	Ref. No.	181729 182311
description	heating element 500W 230V heating circuits 1 thread 3/4" L 295mm W 20mm H 19mm length thermostat sleeves 235mm thermostat sleeves ø 6mm number of thermostat sleeves 1 thermostat sleeve clinging tube ø 6.5mm immersion heater flange with thread connection length 50mm pilot heating element		
For models:	CBE106-VAR091, CBE110-VAR091, CBE120-VAR091, CBE220-VAR091, CCE106, CCE110, CCE120, CCE220, CED106, CED110, CED120, CED220, CEF106, CEF110, CEF120, CEF220, CEM110, CEM120, CPE106, CPE110, CPE120, CPE220, EES060, EES080, FED080, FED150, FED250, FED300, FEK040, FEK060, FEK080, FEK100, FEK150, FER080, FER150, FER250, FER300, FER400, FES040, FES060, FES080, FES100, FES150, LES060, NED080, NED150, NED250, NED300, NEK040, NEK060...(Other models you can see in the webshop)		
spare parts for	415607		
	Part No.	510403	Ref. No. —
	flat gasket fibre ED ø 36.5mm ID ø 27mm thickness 2mm Qty 1 pcs		
accessories for	415607		
	Part No.	510421	Ref. No. —
	gasket copper ED ø 31.8mm ID ø 26.4mm thickness 2.2mm for thread 3/4"		
	Part No.	520234	Ref. No. 166103
	nut thread 3/4" H 5mm brass WS 30 Qty 1 pcs		

			
1			
Part No.	415653	Ref. No.	182415 540824
description	heating element 600W 230V heating circuits 1 mounting ø 47.5mm L 280mm W 36mm H 16mm round flange connection male faston 6.3mm immersion heater tube ø 6.3mm thermostat sleeves ø 7mm length thermostat sleeves 220mm number of thermostat sleeves 1 pilot heating element		
spare parts for	415653		
	Part No.	510408	Ref. No. 060842
	O-ring EPDM thickness 5.34mm ID ø 47mm Qty 1 pcs		
accessories for	415653		
	Part No.	510562	Ref. No. —
	O-ring silicone thickness 5.34mm ID ø 47mm Qty 1 pcs		
	Part No.	550675	Ref. No. 060840
	O-ring Viton thickness 6mm ID ø 47mm Qty 1 pcs		

immersion heating elements



3 hole flange ø47.5mm

			
1			
Part No.	415069	Ref. No.	182521
description	heating element 4500W 220V mounting ø 47.5mm heating circuits 3 L 310mm W 30.5mm H 29mm tube ø 6.3mm connection male faston 6.3mm 3 hole flange immersion heater		
For models:	FES040, NES040, PES048, WES0400		
accessories for	415069		
	Part No.	510408	Ref. No. 060842
	O-ring EPDM thickness 5.34mm ID ø 47mm Qty 1 pcs		
	Part No.	520235	Ref. No. 732204000 817526000
	3 hole flange hole distance 70.5mm perforation ø 6.5mm ID ø 53.5mm		
	Part No.	520236	Ref. No. —
	flange for heating element ID ø 50mm ED ø 90mm hole ø 6.5mm 3 holes		
	Part No.	521012	Ref. No. —
	gasket graphite ED ø 15mm ID ø 5mm thickness 1.2mm Qty 1 pcs		
	Part No.	550002	Ref. No. 144280
	tension strap H 10mm L 21mm W 10mm hole ø 6.5mm for heating element		
	Part No.	550362	Ref. No. —
	blind flange ø 64mm mounting ø 47.5mm		





with compression flange (miscellaneous)





Part No.	415507	Ref. No.	409181
description	heating element 2000W 230V heating circuits 1 L 250mm W 35mm H 25mm connection male faston 6.3mm tube ø 8.5mm immersion heater special fixing mounting distance 21mm		
For models:	KGE122, KGE340, KGE360, KGE660, KGL260, KGL360, KGU113, KGU122, KGU322, KGU340		
spare parts for	415507		
	Part No.	510364	Ref. No. 409186
	gasket Lmm Wmm ø 36mm for heating element thickness 3mm with 4 screw holes		
	Part No.	510365	Ref. No. —
	counterflange ø 36mm Lmm Wmm		

with expansion flange 70 x 18mm









Part No.	415465	Ref. No.	407264
description	heating element 3000W 230V heating circuits 2 flange 70x18mm L 365mm W 65mm connection male faston 6.3mm tube ø 8.5mm immersion heater expansion flange		
For models:	ECD106, ECD220		
accessories for	415465		
	Part No.	379078	Ref. No. —
	temperature probe thermocouple K (NiCr-Ni) cable silicone probe -50 up to 1150°C cable -50 up to +180°C connection 2-wire thread probe ø1.5x100mm cable length 1.8m		









Part No.	415466	Ref. No.	407263
description	heating element 6000W 230V heating circuits 2 flange 70x18mm L 365mm W 65mm connection male faston 6.3mm tube ø 8.5mm immersion heater expansion flange connection length 32mm		
For models:	ECD106, ECD110, ECD120, ECD220		
accessories for	415466		
	Part No.	379078	Ref. No. —
	temperature probe thermocouple K (NiCr-Ni) cable silicone probe -50 up to 1150°C cable -50 up to +180°C connection 2-wire thread probe ø1.5x100mm cable length 1.8m		

with round flange ø47.5mm













Part No.	415888	Ref. No.	181737 182674 182684
description	heating element 12000W 230V heating circuits 3 mounting ø 47.5mm L 510mm W 34mm H 33mm round flange connection male faston 6.3mm immersion heater tube ø 8.5mm connection length 25mm		
For models:	CBE120-VAR091, CBE220-VAR091, CCE120, CCE220, CED120, CED220, CEF120, CEF220, CEM120, CPE120, CPE220		
accessories for	415888		
	Part No.	510562	Ref. No. —
	O-ring silicone thickness 5.34mm ID ø 47mm Qty 1 pcs		
	Part No.	520235	Ref. No. 732204000 817526000
	3 hole flange hole distance 70.5mm perforation ø 6.5mm ID ø 53.5mm		
	Part No.	520236	Ref. No. —
	flange for heating element ID ø 50mm ED ø 90mm hole ø 6.5mm 3 holes		
	Part No.	550002	Ref. No. 144280
	tension strap H 10mm L 21mm W 10mm hole ø 6.5mm for heating element		
	Part No.	550362	Ref. No. —
	blind flange ø 64mm mounting ø 47.5mm		









Part No.	415604	Ref. No.	182520 541218
description	heating element 3000W 230/400V heating circuits 3 L 160mm W 36mm H 25mm connection male faston 6.3mm immersion heater round flange mounting ø 47.5mm		
For models:	FES080, NES080, PES088, WES0800		
accessories for	415604		
	Part No.	510408	Ref. No. 060842
	O-ring EPDM thickness 5.34mm ID ø 47mm Qty 1 pcs		
	Part No.	510562	Ref. No. —
	O-ring silicone thickness 5.34mm ID ø 47mm Qty 1 pcs		
	Part No.	520235	Ref. No. 732204000 817526000
	3 hole flange hole distance 70.5mm perforation ø 6.5mm ID ø 53.5mm		
	Part No.	520236	Ref. No. —
	flange for heating element ID ø 50mm ED ø 90mm hole ø 6.5mm 3 holes		
	Part No.	550002	Ref. No. 144280
	tension strap H 10mm L 21mm W 10mm hole ø 6.5mm for heating element		
	Part No.	550362	Ref. No. —
	blind flange ø 64mm mounting ø 47.5mm		











			
1			
Part No.	417530	Ref. No.	182654
description	heating element 3000W 230V heating circuits 3 L 255mm W 38mm H 32mm tube ø 8.5mm thermostat sleeves ø 6.3mm length thermostat sleeves 19mm number of thermostat sleeves 1 thermostat sleeve centre not clinging connection male faston 6.3mm immersion heater round flange mounting ø 47.5mm		
For models:	FEK080, NEK080, PEK088		
accessories for	417530		
	Part No.	510408	Ref. No. 060842
	O-ring EPDM thickness 5.34mm ID ø 47mm Qty 1 pcs		
	Part No.	510562	Ref. No. —
	O-ring silicone thickness 5.34mm ID ø 47mm Qty 1 pcs		
	Part No.	550002	Ref. No. 144280
	tension strap H 10mm L 21mm W 10mm hole ø 6.5mm for heating element		







			
1			
Part No.	415598	Ref. No.	182655
description	heating element 4500W 230V heating circuits 3 mounting ø 47.5mm L 350mm W 28mm H 34mm round flange connection male faston 6.3mm immersion heater tube ø 6.5mm thermostat sleeves ø 6.5mm number of thermostat sleeves 1 length thermostat sleeves 305mm thermostat sleeve centre not clinging		
For models:	FEK040, NEK040, PEK048		
spare parts for	415598		
	Part No.	510408	Ref. No. 060842
	O-ring EPDM thickness 5.34mm ID ø 47mm Qty 1 pcs		
accessories for	415598		
	Part No.	510562	Ref. No. —
	O-ring silicone thickness 5.34mm ID ø 47mm Qty 1 pcs		
	Part No.	520235	Ref. No. 732204000 817526000
	3 hole flange hole distance 70.5mm perforation ø 6.5mm ID ø 53.5mm		
	Part No.	520236	Ref. No. —
	flange for heating element ID ø 50mm ED ø 90mm hole ø 6.5mm 3 holes		
	Part No.	550002	Ref. No. 144280
	tension strap H 10mm L 21mm W 10mm hole ø 6.5mm for heating element		
	Part No.	550362	Ref. No. —
	blind flange ø 64mm mounting ø 47.5mm		





			
1			
Part No.	418286	Ref. No.	540821
description	heating element 6000W 230V heating circuits 2 L 392mm W 35mm H 40mm tube ø 6.2mm connection male faston 6.3mm immersion heater round flange L1 32mm L2 360mm H1 27mm H2 13mm mounting ø 47.5mm		
accessories for	418286		
	Part No.	510408	Ref. No. 060842
	O-ring EPDM thickness 5.34mm ID ø 47mm Qty 1 pcs		









accessories for	418286		
	Part No.	510562	Ref. No. —
	O-ring silicone thickness 5.34mm ID ø 47mm Qty 1 pcs		
	Part No.	520235	Ref. No. 732204000 817526000
	3 hole flange hole distance 70.5mm perforation ø 6.5mm ID ø 53.5mm		
	Part No.	520236	Ref. No. —
	flange for heating element ID ø 50mm ED ø 90mm hole ø 6.5mm 3 holes		
	Part No.	550002	Ref. No. 144280
	tension strap H 10mm L 21mm W 10mm hole ø 6.5mm for heating element		
	Part No.	550362	Ref. No. —
	blind flange ø 64mm mounting ø 47.5mm		

			
1			
Part No.	415599	Ref. No.	182656
description	heating element 6000W 230V heating circuits 3 L 385mm W 31mm H 36mm tube ø 8.5mm thermostat sleeves ø 6.5mm length thermostat sleeves 180mm number of thermostat sleeves 1 thermostat sleeve centre connection male faston 6.3mm immersion heater round flange mounting ø 47.5mm		
For models:	FEK040, FEK060, FEK080, FEK100, NEK040, NEK060, NEK080, NEK100, NTE182, PEK048, PEK068, PEK088, PEK108		
spare parts for	415599		
	Part No.	510408	Ref. No. 060842
	O-ring EPDM thickness 5.34mm ID ø 47mm Qty 1 pcs		
accessories for	415599		
	Part No.	510408	Ref. No. 060842
	O-ring EPDM thickness 5.34mm ID ø 47mm Qty 1 pcs		
	Part No.	510562	Ref. No. —
	O-ring silicone thickness 5.34mm ID ø 47mm Qty 1 pcs		
	Part No.	520235	Ref. No. 732204000 817526000
	3 hole flange hole distance 70.5mm perforation ø 6.5mm ID ø 53.5mm		
	Part No.	520236	Ref. No. —
	flange for heating element ID ø 50mm ED ø 90mm hole ø 6.5mm 3 holes		
	Part No.	550002	Ref. No. 144280
	tension strap H 10mm L 21mm W 10mm hole ø 6.5mm for heating element		
	Part No.	550362	Ref. No. —
	blind flange ø 64mm mounting ø 47.5mm		



				
Part No.	415405	Ref. No.	182416 540841	
description	heating element 6000W 230V heating circuits 3 L 465mm W 38mm H 24mm tube ø 6.3mm connection male faston 6.3mm immersion heater round flange mounting ø 47.5mm			
For models:	EES060, FED080, FED150, FED250, FED300, FER080, FER150, FER250, FER300, FER400, FES060, FES100, LES060, NED080, NED150, NED250, NED300, NEM100, NER080, NER150, NER250, NER300, NER400, NER500, NES040, NES060, NES080, NES100, PED088, PED158, PED258, PED308, PER088, PER158, PER258, PER308, PES068, PES108			
accessories for	415405			
	Part No.	520235	Ref. No.	732204000 817526000
	3 hole flange hole distance 70.5mm perforation ø 6.5mm ID ø 53.5mm			
	Part No.	520236	Ref. No.	—
	flange for heating element ID ø 50mm ED ø 90mm hole ø 6.5mm 3 holes			
	Part No.	521012	Ref. No.	—
	gasket graphite ED ø 15mm ID ø 5mm thickness 1.2mm Qty 1 pcs			
	Part No.	550002	Ref. No.	144280
	tension strap H 10mm L 21mm W 10mm hole ø 6.5mm for heating element			
	Part No.	550362	Ref. No.	—
	blind flange ø 64mm mounting ø 47.5mm			







				
Part No.	418333	Ref. No.	160116	
description	heating element 7500W 230V heating circuits 3 L 455mm W 42mm H 73mm connection male faston 6.3mm immersion heater round flange L1 105mm L2 334mm H1 34mm H2 39mm mounting ø 47.5mm			
For models:	EES080			
accessories for	418333			
	Part No.	510408	Ref. No.	060842
	O-ring EPDM thickness 5.34mm ID ø 47mm Qty 1 pcs			
	Part No.	510562	Ref. No.	—
	O-ring silicone thickness 5.34mm ID ø 47mm Qty 1 pcs			
	Part No.	520235	Ref. No.	732204000 817526000
	3 hole flange hole distance 70.5mm perforation ø 6.5mm ID ø 53.5mm			
	Part No.	520236	Ref. No.	—
	flange for heating element ID ø 50mm ED ø 90mm hole ø 6.5mm 3 holes			
	Part No.	550002	Ref. No.	144280
	tension strap H 10mm L 21mm W 10mm hole ø 6.5mm for heating element			
	Part No.	550362	Ref. No.	—
	blind flange ø 64mm mounting ø 47.5mm			

				
Part No.	416945	Ref. No.	782407004 782798004	
description	heating element 6000W 230V heating circuits 3 L 470mm W 26mm H 50mm tube ø 6.2mm connection male faston 6.3mm immersion heater round flange L1 105mm L2 365mm H1 25mm H2 25mm mounting ø 47.5mm			
For models:	EES060, FES040, FES060, FES080, FES100, NES040, NES060, NES080, NES100, PES048, PES068, PES088, PES108			
spare parts for	416945			
	Part No.	510408	Ref. No.	060842
	O-ring EPDM thickness 5.34mm ID ø 47mm Qty 1 pcs			
accessories for	416945			
	Part No.	510408	Ref. No.	060842
	O-ring EPDM thickness 5.34mm ID ø 47mm Qty 1 pcs			
	Part No.	510562	Ref. No.	—
	O-ring silicone thickness 5.34mm ID ø 47mm Qty 1 pcs			
	Part No.	520235	Ref. No.	732204000 817526000
	3 hole flange hole distance 70.5mm perforation ø 6.5mm ID ø 53.5mm			
	Part No.	520236	Ref. No.	—
	flange for heating element ID ø 50mm ED ø 90mm hole ø 6.5mm 3 holes			
	Part No.	550002	Ref. No.	144280
	tension strap H 10mm L 21mm W 10mm hole ø 6.5mm for heating element			
	Part No.	550362	Ref. No.	—
	blind flange ø 64mm mounting ø 47.5mm			







				
Part No.	415416	Ref. No.	182539 782799004	
description	heating element 7500W 230V heating circuits 3 L 460mm W 37mm H 26mm tube ø 6.3mm thermostat sleeves ø 7mm length thermostat sleeves 200mm number of thermostat sleeves 1 thermostat sleeve eccentric, non clinging connection male faston 6.3mm immersion heater round flange mounting ø 47.5mm			
spare parts for	415416			
	Part No.	510408	Ref. No.	060842
	O-ring EPDM thickness 5.34mm ID ø 47mm Qty 1 pcs			
accessories for	415416			
	Part No.	520235	Ref. No.	732204000 817526000
	3 hole flange hole distance 70.5mm perforation ø 6.5mm ID ø 53.5mm			
	Part No.	520236	Ref. No.	—
	flange for heating element ID ø 50mm ED ø 90mm hole ø 6.5mm 3 holes			
	Part No.	521012	Ref. No.	—
	gasket graphite ED ø 15mm ID ø 5mm thickness 1.2mm Qty 1 pcs			
	Part No.	550002	Ref. No.	144280
	tension strap H 10mm L 21mm W 10mm hole ø 6.5mm for heating element			
	Part No.	550362	Ref. No.	—
	blind flange ø 64mm mounting ø 47.5mm			









			
Part No.	415600	Ref. No.	182657
description	heating element 7500W 230V heating circuits 3 L 520mm W 34mm H 32mm tube ø 9mm thermostat sleeves ø 6.3mm length thermostat sleeves 170mm number of thermostat sleeves 1 thermostat sleeve centre not clinging connection male faston 6.3mm connection length 30mm immersion heater round flange mounting ø 47.5mm		
For models:	FEK150, NEK150, PEK158		
accessories for	415600		
	Part No.	510408	Ref. No. 060842
	O-ring EPDM thickness 5.34mm ID ø 47mm Qty 1 pcs		
	Part No.	510562	Ref. No. —
	O-ring silicone thickness 5.34mm ID ø 47mm Qty 1 pcs		
	Part No.	520235	Ref. No. 732204000 817526000
	3 hole flange hole distance 70.5mm perforation ø 6.5mm ID ø 53.5mm		
	Part No.	520236	Ref. No. —
	flange for heating element ID ø 50mm ED ø 90mm hole ø 6.5mm 3 holes		
	Part No.	550002	Ref. No. 144280
	tension strap H 10mm L 21mm W 10mm hole ø 6.5mm for heating element		
	Part No.	550362	Ref. No. —
	blind flange ø 64mm mounting ø 47.5mm		







			
Part No.	416946	Ref. No.	182539 782799004
description	heating element 7500W 230V heating circuits 3 L 645mm W 24mm H 60mm tube ø 6.2mm connection male faston 6.3mm immersion heater round flange L1 110mm L2 525mm H1 30mm H2 30mm mounting ø 47.5mm		
For models:	FES150, NES150, PES158, WES1500		
accessories for	416946		
	Part No.	510408	Ref. No. 060842
	O-ring EPDM thickness 5.34mm ID ø 47mm Qty 1 pcs		
	Part No.	510562	Ref. No. —
	O-ring silicone thickness 5.34mm ID ø 47mm Qty 1 pcs		
	Part No.	520235	Ref. No. 732204000 817526000
	3 hole flange hole distance 70.5mm perforation ø 6.5mm ID ø 53.5mm		
	Part No.	520236	Ref. No. —
	flange for heating element ID ø 50mm ED ø 90mm hole ø 6.5mm 3 holes		
	Part No.	550002	Ref. No. 144280
	tension strap H 10mm L 21mm W 10mm hole ø 6.5mm for heating element		
	Part No.	550362	Ref. No. —
	blind flange ø 64mm mounting ø 47.5mm		

			
Part No.	418270	Ref. No.	540717
description	heating element 9000W 230V heating circuits 3 L 535mm W 36mm H 45mm tube ø 6.2mm connection male faston 6.3mm immersion heater round flange L1 35mm L2 500mm H1 35mm H2 10mm mounting ø 47.5mm		
accessories for	418270		
	Part No.	510408	Ref. No. 060842
	O-ring EPDM thickness 5.34mm ID ø 47mm Qty 1 pcs		
	Part No.	510562	Ref. No. —
	O-ring silicone thickness 5.34mm ID ø 47mm Qty 1 pcs		
	Part No.	520235	Ref. No. 732204000 817526000
	3 hole flange hole distance 70.5mm perforation ø 6.5mm ID ø 53.5mm		
	Part No.	520236	Ref. No. —
	flange for heating element ID ø 50mm ED ø 90mm hole ø 6.5mm 3 holes		
	Part No.	550002	Ref. No. 144280
	tension strap H 10mm L 21mm W 10mm hole ø 6.5mm for heating element		
	Part No.	550362	Ref. No. —
	blind flange ø 64mm mounting ø 47.5mm		

			
Part No.	418287	Ref. No.	540842
description	heating element 9000W 230V heating circuits 3 L 540mm W 37mm H 28mm tube ø 6.2mm immersion heater round flange mounting ø 47.5mm		
accessories for	418287		
	Part No.	510408	Ref. No. 060842
	O-ring EPDM thickness 5.34mm ID ø 47mm Qty 1 pcs		
	Part No.	510562	Ref. No. —
	O-ring silicone thickness 5.34mm ID ø 47mm Qty 1 pcs		
	Part No.	520235	Ref. No. 732204000 817526000
	3 hole flange hole distance 70.5mm perforation ø 6.5mm ID ø 53.5mm		
	Part No.	520236	Ref. No. —
	flange for heating element ID ø 50mm ED ø 90mm hole ø 6.5mm 3 holes		
	Part No.	550002	Ref. No. 144280
	tension strap H 10mm L 21mm W 10mm hole ø 6.5mm for heating element		
	Part No.	550362	Ref. No. —
	blind flange ø 64mm mounting ø 47.5mm		





1 			
Part No.	415875	Ref. No.	181736 182680
description	heating element 9000W 230V heating circuits 3 mounting ø 47.5mm L 518mm W 34mm H 37mm round flange connection male faston 6.3mm immersion heater tube ø 8.5mm		
For models:	CBE106-VAR091, CBE110-VAR091, CCE106, CCE110, CED106, CED110, CEF106, CEF110, CEM110, CPE106, CPE110		
accessories for	415875		
	Part No.	510408	Ref. No. 060842
	O-ring EPDM thickness 5.34mm ID ø 47mm Qty 1 pcs		
	Part No.	510562	Ref. No. —
	O-ring silicone thickness 5.34mm ID ø 47mm Qty 1 pcs		
	Part No.	520235	Ref. No. 732204000 817526000
	3 hole flange hole distance 70.5mm perforation ø 6.5mm ID ø 53.5mm		
	Part No.	520236	Ref. No. —
	flange for heating element ID ø 50mm ED ø 90mm hole ø 6.5mm 3 holes		
	Part No.	550002	Ref. No. 144280
	tension strap H 10mm L 21mm W 10mm hole ø 6.5mm for heating element		
	Part No.	550362	Ref. No. —
	blind flange ø 64mm mounting ø 47.5mm		

1			
Part No.	416940	Ref. No.	182338
description	heating element 9900W 230V mounting ø 47.5mm immersion heater		
accessories for	416940		
	Part No.	510408	Ref. No. 060842
	O-ring EPDM thickness 5.34mm ID ø 47mm Qty 1 pcs		
	Part No.	510562	Ref. No. —
	O-ring silicone thickness 5.34mm ID ø 47mm Qty 1 pcs		
	Part No.	520235	Ref. No. 732204000 817526000
	3 hole flange hole distance 70.5mm perforation ø 6.5mm ID ø 53.5mm		
	Part No.	520236	Ref. No. —
	flange for heating element ID ø 50mm ED ø 90mm hole ø 6.5mm 3 holes		
	Part No.	550002	Ref. No. 144280
	tension strap H 10mm L 21mm W 10mm hole ø 6.5mm for heating element		
	Part No.	550362	Ref. No. —
	blind flange ø 64mm mounting ø 47.5mm		

heating elements for convection

1 			
Part No.	416918	Ref. No.	182331
description	heating element 4000W 230V heating circuits 1		
For models:	NEH415, NEH505, NEH615, NEH705, NGH405, NGH505, NGH605, NGH725		



1 			
Part No.	415603	Ref. No.	182324
description	heating element 4000W 400V heating circuits 1 ID ø 176mm ED ø 210mm L 240mm H 42mm L1 25mm W1 31mm H1 5mm H2 38mm flange length 70mm flange width 22mm hole distance 5.7mm connection male faston 6.3mm tube ø 6.3mm convection heating element hole ø 5mm rectangular flange		
For models:	FEH415, FEH615, FEH705, FEH715, FGH415, FGH615, NEH415, NEH505, NEH615, NEH705, NGH405, NGH415, NGH505, NGH605, NGH615, NGH725		
accessories for	415603		
	Part No.	510368	Ref. No. —
	gasket L 70mm W 23.5mm hole ø 5mm hole distance 56mm FIBER thickness 2mm for heating element		







1 			
Part No.	415744	Ref. No.	182663
description	heating element 4800W 230V heating circuits 2 ID ø 182mm ED ø 214mm L 266mm H 37mm L1 42mm W1 30mm H1 16mm H2 21mm flange length 70mm flange width 22mm hole distance 57mm connection male faston 6.3mm tube ø 6.3mm convection heating element mounting thread M5 rectangular flange with thread bolt		
For models:	ECL484		









			
1			
Part No.	415602	Ref. No.	182662
description	heating element 4800W 400V heating circuits 2 ID ø 183mm ED ø 213mm L 265mm H 33mm L1 50mm W1 31mm H1 13mm H2 20mm flange length 70mm flange width 22mm hole distance 56mm connection male faston 6.3mm connection length 28mm tube ø 6.3mm convection heating element mounting thread M5 rectangular flange with thread bolt		
For models:	ECL484		

			
1			
Part No.	416917	Ref. No.	182523
description	heating element 6000W 230V heating circuits 2 ID ø 180mm ED ø 215mm L 240mm H 42mm L1 20mm W1 37mm H1 5mm H2 37mm flange length 70mm flange width 22mm hole distance 56mm tube ø 6.3mm		

			
1			
Part No.	415601	Ref. No.	182522
description	heating element 6000W 400V heating circuits 1 ID ø 175mm ED ø 210mm L 240mm H 46mm L1 65mm W1 30mm H1 43mm H2 3mm flange length 70mm flange width 22mm hole distance 55mm connection male faston 6.3mm connection length 20mm tube ø 6.5mm convection heating element hole ø 5mm rectangular flange		
For models:	EHP601, LEH405, LEH505, LEH605, LEH705, LGH405, LGH605		
spare parts for	415601		
	Part No.	510368	Ref. No. —
	gasket L 70mm W 23.5mm hole ø 5mm hole distance 56mm FIBER thickness 2mm for heating element		

			
1			
Part No.	415911	Ref. No.	407449
description	heating element 9000W 230V heating circuits 4 ID ø 310mm ED ø 333mm L 410mm H 115mm L1 77mm W1 75mm H1 15mm H2 100mm thread M14x1.5 8 hole fixing connection male faston 6.3mm tube ø 8.5mm convection heating element		
For models:	ECD106		
accessories for	415911		
	Part No.	510417	Ref. No. —
	flat gasket fibre ED ø 20mm ID ø 14mm thickness 2mm Qty 1 pcs		
	Part No.	520228	Ref. No. 40156998
	tooth lock washer ID ø 15.3mm ED ø 24mm steel Qty 1 pcs for thread M14		
	Part No.	520230	Ref. No. 407298
	nut thread M14x1.5 H 5mm WS 19 zinc-coated steel Qty 1 pcs		
	Part No.	521101	Ref. No. —
	nut thread M14x1.5 H 5mm WS 19 SS Qty 1 pcs		
	Part No.	550262	Ref. No. —
	flat gasket copper ED ø 20mm ID ø 14mm thickness 2mm		

			
1			
Part No.	415469	Ref. No.	407299
description	heating element 2000W 220V heating circuits 1 L 95mm W 520mm connection length 24mm connection male faston 6.3mm tube ø 6.3mm thread M14x1.5 2 hole fixing convection heating element mounting distance 514mm		
For models:	ECD110, ECD120		
accessories for	415469		
	Part No.	510417	Ref. No. —
	flat gasket fibre ED ø 20mm ID ø 14mm thickness 2mm Qty 1 pcs		
	Part No.	520228	Ref. No. 40156998
	tooth lock washer ID ø 15.3mm ED ø 24mm steel Qty 1 pcs for thread M14		
	Part No.	520230	Ref. No. 407298
	nut thread M14x1.5 H 5mm WS 19 zinc-coated steel Qty 1 pcs		
	Part No.	521101	Ref. No. —
	nut thread M14x1.5 H 5mm WS 19 SS Qty 1 pcs		
	Part No.	550262	Ref. No. —
	flat gasket copper ED ø 20mm ID ø 14mm thickness 2mm		



<p>1</p>			
Part No.	415554	Ref. No.	407496
description	heating element 2500W 230V heating circuits 1 L 148mm W 534mm connection male faston 6.3mm tube ø 6.3mm thread M14x1.5 2 hole fixing convection heating element mounting distance 528mm		
For models:	ECD220		
spare parts for	415554		
	Part No.	510420	Ref. No. 407297
	gasket copper ED ø 19.9mm ID ø 14.3mm thickness 2mm Qty 1 pcs		
accessories for	415554		
	Part No.	510417	Ref. No. —
	flat gasket fibre ED ø 20mm ID ø 14mm thickness 2mm Qty 1 pcs		
	Part No.	520228	Ref. No. 40156998
	tooth lock washer ID ø 15.3mm ED ø 24mm steel Qty 1 pcs for thread M14		
	Part No.	520230	Ref. No. 407298
	nut thread M14x1.5 H 5mm WS 19 zinc-coated steel Qty 1 pcs		
	Part No.	521101	Ref. No. —
	nut thread M14x1.5 H 5mm WS 19 SS Qty 1 pcs		
	Part No.	550262	Ref. No. —
	flat gasket copper ED ø 20mm ID ø 14mm thickness 2mm		

<p>1</p>			
Part No.	415571	Ref. No.	181740 182682
description	heating element 3000W 230V heating circuits 1 L 360mm W 120mm tube ø 6.3mm thread M12x1 cable length 1000mm 2 hole fixing convection heating element		
For models:	CBE106, CBE106-VAR091, CBE110, CBE110-VAR091, CCE106, CCE110, CEC106, CEC110, CED106, CED110, CEF106, CEF110, CEM110, CPE106, CPE110		

<p>1</p>			
Part No.	415560	Ref. No.	181741 182683
description	heating element 4000W 230V heating circuits 1 L 353mm W 80mm tube ø 9mm thread M12x1 cable length 500mm W1 353mm 2 hole fixing convection heating element mounting distance 340mm		
For models:	CBE120, CBE120-VAR091, CBE220, CBE220-VAR091, CCE120, CCE220, CEC120, CEC220, CED120, CED220, CEF120, CEF220, CEM120, CPE120, CPE220		

radiation heaters

square

<p>1</p>			
Part No.	490144	Ref. No.	160366
description	radiation heater L 300mm W 300mm 2500W 400V connections 3 square without pan detection EGO		
For models:	FEH500, FEH503, FEH505, FEH700, FEH705		
spare parts for	490144		
	Part No.	499157	Ref. No. —
	protection pipe for temperature probe ceramic L 297mm ED ø 7mm ID ø 5mm		

<p>1</p>			
Part No.	490108	Ref. No.	160368
description	radiation heater L 300mm W 300mm 2500W 400V connections 3+2 connection type screw with pan detection EGO		
For models:	FEH510, FEH513, FEH515, FEH710, FEH715		
spare parts for	490108		
	Part No.	499157	Ref. No. —
	protection pipe for temperature probe ceramic L 297mm ED ø 7mm ID ø 5mm		

<p>1</p>			
Part No.	490145	Ref. No.	160367 947962002
description	radiation heater L 300mm W 300mm 3500W 400V connections 3 square without pan detection EGO		
For models:	FEH500, FEH503, FEH505, FEH700, FEH705		
spare parts for	490145		
	Part No.	499157	Ref. No. —
	protection pipe for temperature probe ceramic L 297mm ED ø 7mm ID ø 5mm		



1

Part No.	490143	Ref. No.	160369
description	radiation heater L 300mm W 300mm 3500W 400V connections 3+2 square with pan detection EGO		
For models:	FEH510, FEH513, FEH515, FEH710, FEH715		



1

Part No.	490195	Ref. No.	160398
description	radiation heater L 300mm W 300mm 4000W 400V heating circuits 2 H 40mm connection type screw without pan detection EGO		

1

Part No.	416923	Ref. No.	538999 987068006 990580006
description	radiation heater 230V ceramic griddle		
For models:	LEB431, SEB431		

1

Part No.	416925	Ref. No.	987070006 990581006
description	radiation heater 230V ceramic griddle		
For models:	LEB631, SEB631		

1

Part No.	416929	Ref. No.	988235006 990574006
description	radiation heater 230V ceramic griddle		
For models:	NEB631		

1

Part No.	416922	Ref. No.	540985 987067006 990582006
description	radiation heater 400V ceramic griddle		
For models:	LEB231, SEB231		

1

Part No.	416924	Ref. No.	540993 987069006 990583006
description	radiation heater 400V ceramic griddle		
For models:	LEB431, SEB431		

1

Part No.	416926	Ref. No.	538992 987071006 990584006
description	radiation heater 400V ceramic griddle		
For models:	LEB631, SEB631		

1

Part No.	416932	Ref. No.	160344 988238006 990578006
description	radiation heater 400V ceramic griddle		
For models:	NEB831		

1

Part No.	416933	Ref. No.	984748002
description	radiation heater ceramic griddle		
For models:	TEB231		



1

Part No.	416935	Ref. No.	986616002
description	radiation heater ceramic griddle		
For models:	TEB631		



1

Part No.	416934	Ref. No.	409085 986615002
description	radiation heater rectangular 1300W 400V L 480mm W 470mm connections 3x 2 ceramic griddle		
For models:	TEB431		



1

Part No.	416920	Ref. No.	996651006
description	radiation heater rectangular 2300W 230V L 456mm W 220mm		
For models:	FEB430, FEB630, PEB438, PEB638		



1

Part No.	416921	Ref. No.	987066006 990049006 990579006
description	radiation heater rectangular 2500W 230V L 465mm W 295mm heating circuits 1 connections 2 ceramic griddle		
For models:	LEB231, SEB231		



1

Part No.	416911	Ref. No.	996887006
description	radiation heater rectangular 3200W 400V L 420mm W 278mm		
For models:	EEP500		



1

Part No.	416937	Ref. No.	540963 988312006
description	radiation heater rectangular 3450W 220V L 458mm W 320mm heating circuits 3 connections 3x 2 bain marie		
For models:	TEW250		



1

Part No.	416897	Ref. No.	942867006 996887006
description	radiation heater rectangular 3500W 400V L 415mm W 275mm H 46mm heating circuits 2 connections 2x 2		
For models:	EEB230, EEB430		



1

Part No.	419180	Ref. No.	160384
description	radiation heater rectangular 3500W 400V L 415mm W 275mm heating circuits 1 connections 2x1 connection type F6.3		



1-circuit



1

Part No.	490047	Ref. No.	181726 182274 182679 538695 540293
description	radiation heater ø 230mm 2100W 230V heating circuits 1 7-position control with temperature signalization connections 4+2 connection type male faston 6.3mm EGO		



1

Part No.	490137	Ref. No.	182629 182686
description	radiation heater ø 230mm 2300W 230V		
For models:	LEH500, LEH503, LEH505, LEH700, LEH703, LEH705		



1

Part No.	490136	Ref. No.	181721 182257 538253
description	radiation heater ø 230mm 2300W 230V heating circuits 1 H 32mm energy regulation with temperature signalization with ribbon heater connections 2+2 connection type male faston 6.3mm vertical EGO		
For models:	SEH300, TEH300		



1

Part No.	490050	Ref. No.	160361
description	radiation heater ø 250mm 2500W 230V heating circuits 1 with ribbon heater		
For models:	EEH210, EEH300, EEH410, EEH413, EEH500, EEH503, EEH610, EEH613, EEH700, EEH703		

2-circuit



1

Part No.	490028	Ref. No.	181713 182260 538254
description	radiation heater ø 230mm 2100W 230V heating circuits 2 energy regulation with temperature signalization partial power 650W with heating coil connections 3+2 connection type male faston 6.3mm EGO		



1

Part No.	490135	Ref. No.	160303 160349 181713 181718 182260 182288 502383 538254 538629 564648
description	radiation heater ø 230mm 2200W 230V heating circuits 2 energy regulation with temperature limiter partial power 750W with ribbon heater connections 3+2 connection type male faston 6.3mm EGO		
For models:	SEH300, TEH300		



1

Part No.	490146	Ref. No.	160362
description	radiation heater ø 250mm 2500W 230V heating circuits 2 energy regulation without temperature signalization partial power 1250W with heating coil connections 3 connection type male faston 6.3mm EGO		
For models:	EEH210, EEH410, EEH413, EEH610, EEH613		



hot plates

square & rectangular

tiltable



1

Part No.	490085	Ref. No.	182254 182261
description	hot plate dimensions 300x300mm 2500W 230V with cast edge tilt boiling plate connection 3 screw clamps H 43mm square		
For models:	EHN401, EHN402, EHN601, EHN602, EHN801, EHN802, NEH210, NEH212, NEH410, NEH413, NEH415, NEH610, NEH613, NEH615		



1

Part No.	490086	Ref. No.	181744 182250 182262
description	hot plate dimensions 300x300mm 2500W 400V with cast edge tilt boiling plate connection 3 screw clamps H 43mm square		
For models:	EHN401, EHN402, EHN601, EHN602, EHN801, EHN802, FEH210, FEH410, FEH413, FEH415, FEH610, FEH613, FEH615, NEH210, NEH212, NEH410, NEH413, NEH415, NEH610, NEH613, NEH615, PEH218, PEH418, PEH618		



1

Part No.	490089	Ref. No.	182253
description	hot plate dimensions 300x300mm 4000W 230V with cast edge tilt boiling plate connection 4 screw clamps H 43mm square		
For models:	NEH410, NEH413, NEH415, NEH610, NEH613, NEH615		



1

Part No.	490090	Ref. No.	181743 182033 182249
description	hot plate dimensions 300x300mm 4000W 400V with cast edge tilt boiling plate connection 4 screw clamps H 43mm square		
For models:	EHN401, EHN402, EHN601, EHN602, EHN801, EHN802, FEH210, FEH410, FEH413, FEH415, FEH610, FEH613, FEH615, NEH210, NEH212, NEH410, NEH413, NEH415, NEH610, NEH613, NEH615, PEH218, PEH418, PEH618		

round

with radiused edge

for domestic and commercial kitchens



1

Part No.	490014	Ref. No.	181956 182241
description	hot plate ø 180mm 1500W 230V connection 4 screw clamps with 8mm spill ring		
For models:	EHP601, LEH405, LEH605		



1

Part No.	490015	Ref. No.	182245
description	hot plate ø 180mm 1500W 400V connection 4 screw clamps with 8mm spill ring		
For models:	LEH405, LEH605		



1

Part No.	490018	Ref. No.	181959 182248
description	hot plate ø 220mm 2000W 230V connection 4 screw clamps with 8mm spill ring		
For models:	EHP601, LEH605, SEH200		



1

Part No.	490019	Ref. No.	182244
description	hot plate ø 220mm 2000W 400V connection 4 screw clamps with 8mm spill ring		
For models:	LEH605, SEH200		



1

Part No.	490020	Ref. No.	182242
description	hot plate ø 220mm 2600W 230V connection 4 screw clamps with 8mm spill ring		
For models:	LEH405, LEH605		
accessories for	490020		
	Part No.	550796	Ref. No.
			—
	fixing plate for hot plate ø220mm		



1

Part No.	490021	Ref. No.	182246
description	hot plate ø 220mm 2600W 400V connection 4 screw clamps with 8mm spill ring		
For models:	LEH405, LEH605		



1

Part No.	490061	Ref. No.	182247
description	hot plate ø 300mm 2500W 230V connection 4 screw clamps with 8mm spill ring		
For models:	LEH405, LEH605		



1

Part No.	490063	Ref. No.	182243
description	hot plate ø 300mm 2500W 400V connection 4 screw clamps with 8mm spill ring		
For models:	LEH405, LEH605		

energy regulators

EGO

1-circuit



1

Part No.	380029	Ref. No.	183237
description	energy regulator		
For models:	TEH300		



1

Part No.	380016	Ref. No.	176189 183139 183160 183184
description	energy regulator 230V 12A dual circuit turn direction right with operation switch 1-pole		
For models:	LEH500, LEH503, LEH505, LEH700, LEH703, LEH705, SEH300		



1

Part No.	380015	Ref. No.	183111 183149 183150 183236 540548
description	energy regulator 230V 13A single-circuit turn direction right shaft ø 6x4.6mm shaft L 23mm mounting thread M4 power release 6-100% no. 50.57021.010		
For models:	EEF040, EEH210, EEH300, EEH410, EEH413, EEH500, EEH503, EEH610, EEH613, EEH700, EEH703, EES060, EES080, FEF040, FEH500, FEH503, FEH505, FEH510, FEH513, FEH515, FEH700, FEH705, FEH710, FEH715, LEB231, LEB431, LEB631, LEF040, LEH500, LEH503, LEH505, LEH700, LEH703, LEH705, NEB431, NEB631, NEB831, NEF040, NEH500, NEH505, NEH700, NEH705, NEK040, NEK060, NEK080, NEK100, NEK150, NEM100, NER080, NER150...(Other models you can see in the webshop)		

1

Part No.	380036	Ref. No.	538255
description	energy regulator 230V 13A turn direction right shaft ø 6x4.6mm mounting thread M12x1 no. 50.57024.010		
accessories for	380036		
	Part No.	510792	Ref. No. —
	hexagonal nut thread M12x1 H 4mm WS 17 stainless steel Qty 1 pcs		

2-circuit



1

Part No.	380027	Ref. No.	161606
description	energy regulator EGO 230V 13A dual circuit turn direction right shaft ø 6x4.6mm shaft L 23mm mounting thread M4 power release 6-70% no. 50.55021.100		

thermostats

bi-metal thermostats

safety bi-metal thermostats



1

Part No.	390171	Ref. No.	409194
description	bi-metal safety thermostat hole distance mm switch-off temp. 110°C 1NC 1-pole 16A connection F6.3		
For models:	KGE122, KGL260, KGU113, KGU122		
accessories for	390171		
	Part No.	510362	Ref. No. 409190
	gasket for thermostat ED ø 40mm ID ø 19mm suitable for COMENDA, MEIKO equiv. no. 630511/0108040		

bi-metal thermostats



1

Part No.	390609	Ref. No.	540276
description	bi-metal thermostat 1NC		



1

Part No.	390123	Ref. No.	409194
description	bi-metal thermostat hole distance 23.8mm switch-off temp. 50°C 1NC 1-pole 16A 250V connection F6.3 2 hole fixing		



1

Part No.	390523	Ref. No.	183240 408273
description	bi-metal thermostat switch-off temp. 140°C 1NC 1-pole 16A connection F6.3		
For models:	ECL484		

control and safety thermostats

EGO

control thermostats

51._ series



1

Part No.	375593	Ref. No.	174637
description	thermostat t.max. 110°C temperature range 85-110°C 1-pole 1NO 15A probe ø 6mm probe L 265mm capillary pipe 2990mm capillary pipe isolated 1700mm gland nut shaft ø 6x4.6mm shaft L 35mm shaft position upper rotation 270° with disc disc ø 12.5mm screw connection M14x1		
For models:	LES060, NES040, NES060, NES080, NES100, NES150, NGR150, NGR250, NGR300, NGR400, NHR080, NHR150, NHR250, NHR300, NHR400, NHR500, NHS040, NHS060, NHS080, NHS100, NHS150, NNR080, NNR150, NNR250, NNR300, NNR400, NNR500, NNS040, NNS060, NNS080, NNS100, NNS150, WESO400, WESO600, WESO800, WES1000, WES1500		



55.10/19_series



Part No.	375070	Ref. No.	540522
description	thermostat t.max. 250°C temperature range 55-250°C 1-pole 1CO 16A probe ø 3.1mm probe L 226mm capillary pipe 1170mm capillary pipe isolated 1100mm gland nut M9x1 shaft L 23mm shaft position upper rotation 270°		
For models:	EEW250, EEW450, EEW452		

55.13_series



Part No.	375008	Ref. No.	174690
description	thermostat t.max. 110°C temperature range 30-110°C 1-pole 1CO 16A probe ø 3.1mm probe L 197mm capillary pipe 3150mm capillary pipe isolated 300mm gland nut shaft L 23mm shaft position° shaft position rotation 270°		



Part No.	390133	Ref. No.	174690
description	thermostat t.max. 125°C temperature range 30-125°C 1-pole 1CO 16A probe ø 3.03mm probe L 160mm capillary pipe 2290mm capillary pipe isolated 1710mm gland nut shaft ø 6x4.6mm shaft L 23mm shaft position upper rotation 270°		
For models:	CEC106, CEC110, CEC120, CEC220, CED106, CED110, CED120, CED220		



Part No.	375086	Ref. No.	407340
description	thermostat t.max. 180°C temperature range 60-180°C 1-pole 1CO 16A probe ø 6mm probe L 90mm capillary pipe 2400mm capillary pipe isolated 2300mm gland nut shaft ø 6x4.6mm shaft L 25mm shaft position upper rotation 270° probe material SS		
For models:	ECD110, ECD120, ECD220		

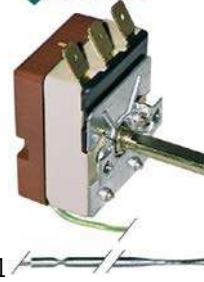

Part No.	375010	Ref. No.	174664
description	thermostat t.max. 250°C temperature range 50-250°C 1-pole 1NO 16A probe ø 3.1mm probe L 208mm capillary pipe 1130mm capillary pipe isolatedmm gland nut shaft L 23mm shaft position upper rotation 270°		
For models:	EAB081, EAB101, EAB102, EAB112		



Part No.	390146	Ref. No.	176168
description	thermostat t.max. 280°C temperature range 50-280°C 1-pole 1NO 16A probe ø 3.1mm probe L 160mm capillary pipe 1230mm capillary pipe isolated 800mm gland nut shaft L 23mm shaft position upper rotation 270°		
For models:	CEC106, CEC110, CEC120, CEC220, EAB051, ECL484, EDC106		





Part No.	375087	Ref. No.	407276
description	thermostat t.max. 300°C temperature range 50-300°C 1-pole 1CO 16A probe ø 3.03mm probe L 160mm capillary pipe 1130mm capillary pipe isolated 1103mm gland nut shaft L 23mm shaft position upper rotation 270°		
For models:	ECD106, ECD110, ECD120, ECD220		



Part No.	375612	Ref. No.	161614
description	thermostat t.max. 324°C temperature range 54-324°C 1-pole 1NO 16A probe ø 3.03mm probe L 147mm capillary pipe 1270mm capillary pipe isolated 1180mm gland nut shaft ø 6x4.6mm shaft L 23mm shaft position upper rotation 270°		
For models:	EEB230, EEB430, EEP500, EGP500, FEB430, FEB630, FEH415, FEH615, FEP230, FEP330, FEP600, FEP610, FEP900, FEP910, FEW250, FEW252, FGW250, NEP203, NEP303, NEP400, NEP600, NEP601, NEP900, NEP901, NGP600, NGP900, PEB438, PEB638, PEP238, PEP338, PEP608, PEP618, PEP908, PEP918, PEW458, PEW658, PGP608, PGP618, PGP908, PGP918, PGW458		



Part No.	375088	Ref. No.	407266
description	thermostat t.max. 300°C temperature range 60-300°C 1-pole 1NO 16A probe ø 4mm probe L 100mm capillary pipe 830mm capillary pipe isolated 800mm gland nut shaft L 15mm shaft position upper rotation 270°		
For models:	ECD106, ECD110, ECD120, ECD220		



Part No.	375773	Ref. No.	161624
description	thermostat t.max. 440°C temperature range fixed 440°C 1-pole 1NO 16A probe ø 3.9mm probe L 228mm capillary pipe 1130mm capillary pipe isolated 850mm gland nut shaft ømm shaft Lmm shaft position rotation°		
For models:	EEH210, EEH410, EEH413, EEH610, EEH613		



Part No.	375505	Ref. No.	174681
description	thermostat t.max. 320°C temperature range 50-320°C 1-pole 1NO 16A probe ø 3mm probe L 160mm capillary pipe 870mm capillary pipe isolatedmm gland nut shaft ø 6x4.6mm shaft L 23mm shaft position upper rotation 270°		
For models:	ECL484		



Part No.	375085	Ref. No.	407279
description	thermostat t.max. 90°C temperature range 0-90°C 1-pole 1CO 16A probe ø 3.1mm probe L 247mm capillary pipe 1430mm capillary pipe isolated 1400mm gland nut shaft ø 6x4.6mm shaft L 18mm shaft position upper probe material SS		
For models:	ECD106, ECD110, ECD120, ECD220		



E-G-O



Part No.	375133	Ref. No.	174690
description	thermostat t.max. 90°C temperature range 30-90°C 1-pole capillary pipe isolated 600mm gland nut		

55.34_ series

E-G-O



Part No.	375697	Ref. No.	540525
description	thermostat t.max. 120°C temperature range fixed 120°C 2-pole 2CO 16A probe \varnothing 3.1mm probe L 305mm capillary pipe 720mm capillary pipe isolated 600mm gland nut shaft Lmm		

For models: EEF124, EEF224

accessories for 375697



Part No.	550039	Ref. No.	—
probe clip for pipe \varnothing 8.5mm for probe \varnothing 3.1mm Qty 1 pcs			

E-G-O



Part No.	375708	Ref. No.	540444
description	thermostat t.max. 188°C temperature range 95-188°C 3-pole 3NO 16A probe \varnothing 6mm probe L 117mm capillary pipe 1780mm capillary pipe isolated 1400mm gland nut shaft \varnothing \varnothing 6x4.6mm shaft L 23mm shaft position upper rotation 270°		

E-G-O



Part No.	375097	Ref. No.	355637
description	thermostat t.max. 195°C temperature range 95-195°C 3-pole 3NO 16A probe \varnothing 6mm probe L 117mm capillary pipe 1780mm capillary pipe isolated 1400mm gland nut M9x1 shaft \varnothing \varnothing 6x4.6mm shaft L 23mm shaft position upper rotation 270°		

For models: LEF124, LEF224, NEF124, NEF144, NEF176, NEF224, NEF244, SEF124, SEF144, SEF224

E-G-O



Part No.	375422	Ref. No.	152101 152105
description	thermostat t.max. 210°C temperature range 95-210°C 3-pole 3NO 16A probe \varnothing 3.1mm probe L 226mm capillary pipe 1780mm capillary pipe isolated 1600mm gland nut shaft \varnothing \varnothing 6x4.6mm shaft L 23mm shaft position upper rotation 270°		

For models: TEF124, TEF144, TEF224

55.40_ series

E-G-O



Part No.	375658	Ref. No.	540568
description	thermostat t.max. 300°C temperature range 60-204°C/135-300°C 4-pole 2NO/2NO 16A probe \varnothing 4mm probe L 128mm capillary pipe 880mm capillary pipe isolated 800mm gland nut shaft \varnothing \varnothing 6x4.6mm shaft L 23mm shaft position upper rotation 310°		

For models: EEW400



safety thermostats

51._ series



Part No.	390144	Ref. No.	176592
description	safety thermostat switch-off temp. 340°C 1-pole capillary pipe isolatedmm gland nut		



Part No.	375090	Ref. No.	407275
description	safety thermostat switch-off temp. 365°C 2-pole 16A probe ø 4mm probe L 120mm capillary pipe 1170mm capillary pipe isolated 1100mm gland nut probe SS		
For models:	ECD106, ECD110, ECD120, ECD220		

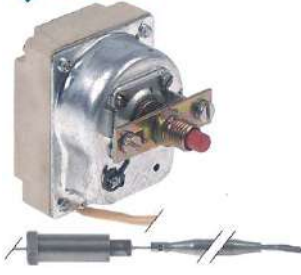

Part No.	390132	Ref. No.	176194
description	thermostat capillary pipe isolatedmm gland nut		
For models:	NGF144, NGF224, PGF148, PGF228		

55.13_ series



Part No.	375519	Ref. No.	540414
description	safety thermostat switch-off temp. 130°C 1-pole 1NO 16A probe ø 6mm probe L 129mm capillary pipe 830mm capillary pipe isolatedmm gland nut mounting thread M8x1 probe SS		

accessories for	375519		
Part No.	102067	Ref. No.	—
description	nut thread M8x1 H 3mm brass Qty 1 pcs type SEF 1		

55.31_ series



Part No.	375102	Ref. No.	176174
description	safety thermostat switch-off temp. 230°C 3-pole 20A probe ø 6mm probe L 219mm capillary pipe 1730mm capillary pipe isolated 1400mm gland nut probe SS		
For models:	LEF124, LEF224, NEF124, NEF144, NEF176, NEF224, NEF244, SEF124, SEF144, SEF224		

55.32_ series



Part No.	375707	Ref. No.	540443
description	safety thermostat switch-off temp. 230°C 3-pole 20A probe ø 6mm probe L 87mm capillary pipe 1490mm capillary pipe isolated 1100mm gland nut M9x1 probe SS		



E·G·O



1

Part No.	375695	Ref. No.	540470
description	safety thermostat switch-off temp. 350°C 3-pole 20A probe ø 6mm probe L 77mm capillary pipe 890mm capillary pipe isolatedmm gland nut probe SS		

E·G·O



1

Part No.	375706	Ref. No.	540406
description	safety thermostat switch-off temp. 400°C 3-pole 3NC 20A probe ø 3.9mm probe L 228mm capillary pipe 1190mm capillary pipe isolatedmm gland nut probe SS		

E·G·O

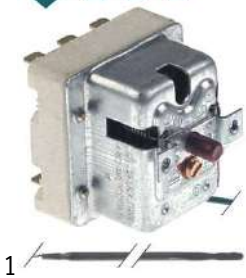

1

Part No.	375627	Ref. No.	540559
description	safety thermostat switch-off temp. 480°C 3-pole 20A probe ø 4mm probe L 230mm capillary pipe 890mm capillary pipe isolatedmm gland nut probe probe material SS		
For models:	EEW400		

55.33_ series

E·G·O



1

Part No.	375421	Ref. No.	152102
description	safety thermostat switch-off temp. 240°C 3-pole 20A probe ø 3.1mm probe L 226mm capillary pipe 1170mm capillary pipe isolated 960mm gland nut probe SS		
For models:	FEF124, FEF144, FEF144e, FEF170, FEF180, FEF224, FEF224e, PEF128, PEF148, PEF178, PEF188, PEF228, TEF124, TEF144, TEF224		

E·G·O



1

Part No.	375698	Ref. No.	540579
description	safety thermostat switch-off temp. 250°C 3-pole 20A probe ø 3.1mm probe L 307mm capillary pipe 710mm capillary pipe isolated 700mm gland nut probe SS		
For models:	EEF124, EEF224		

56._ series

E·G·O



1

Part No.	375591	Ref. No.	152433
description	safety thermostat switch-off temp. 147°C 1-pole 16A probe ø 6mm probe L 77mm capillary pipe 1860mm capillary pipe isolated 1350mm gland nut probe		
For models:	CBE106-VAR091, CBE110-VAR091, CBE120-VAR091, CBE220- VAR091, CCE106, CCE110, CCE120, CCE220, CPE106, CPE110, CPE120, CPE220, FES040, FES060, FES080, FES100, FES150, FGS040, FGS060, FGS080, FGS100, FGS150, PES048, PES068, PES088, PES108, PES158, PGS048, PGS068, PGS088		





1

Part No.	375531	Ref. No.	152432 176592
description	safety thermostat switch-off temp. 340°C 1-pole 16A probe ø 4mm probe L 100mm capillary pipe 1860mm capillary pipe isolated 1710mm gland nut		
For models:	CBE106, CBE106-VAR091, CBE110, CBE110-VAR091, CBE120, CBE120-VAR091, CBE220, CBE220-VAR091, CBG110, CBG120, CCE106, CCE110, CCE120, CCE220, CPE106, CPE110, CPE120, CPE220		

accessories for	375406			
	Part No.	112311	Ref. No.	—
	knob adapter shaft ø 6x4.6mm L 0mm with spring			

control thermostats with operation switch

55.13_series



1

Part No.	375037	Ref. No.	355693
description	thermostat t.max. 110°C 1-pole capillary pipe isolatedmm gland nut		

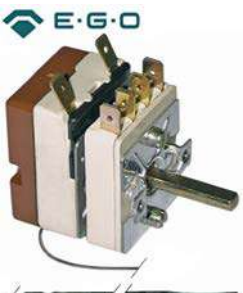

1

Part No.	375408	Ref. No.	174677
description	thermostat t.max. 320°C temperature range 50-320°C 1-pole 1NO 16A probe ø 3.03mm probe L 160mm capillary pipe 1150mm capillary pipe isolatedmm gland nut shaft ø ø6x4.6mm shaft L 23mm shaft position upper rotation 270° outer switch 2NO		
For models:	EEB230, EEB430, EEH413, EEH503, EEH613, EEH703, EEP500, EGH413, EGH613, EGP500, FEB430, FEB630, FEH413, FEH415, FEH503, FEH505, FEH513, FEH515, FEH613, FEH615, FEH705, FEH715, FEP600, FEP900, FGH413, FGH415, FGH613, FGH615, LEB270, LEB430, LEG420, LEH405, LEH503, LEH505, LEH605, LEH703, LEH705, LEP400, LGH405, LGH605, NEB430, NEB630, NEG420, NEH413, NEH415, NEH505, NEH613, NEH615, NEH705, NEP060...(Other models you can see in the webshop)		



1

Part No.	375406	Ref. No.	355693
description	thermostat t.max. 110°C temperature range 30-110°C 1-pole 1CO 16A probe ø 6mm probe L 113mm capillary pipe 2380mm capillary pipe isolated 1700mm gland nut M9x1 shaft ø ø6x4.6mm shaft L 18mm shaft position upper rotation 270° outer switch 2NO		
For models:	FEH613, FEH615, FEH705, FEH715, FEW250, FEW252, FGH613, FGH615, LEH605, LEH703, LEH705, LEW450, LEW452, LGH605, LGH607, NEA182, NEH212, NEH613, NEH615, NEH705, NEW180, NEW182, NEW250, NEW252, NEW450, NEW452, NGH202, NGH603, NGH605, NGH607, NGH613, NGH615, NGH617, NGH723, NGH725, NGH727, NGH733, NGH737, PEW458, PEW658, SEW250, SEW400, SEW450, TEW250, TEW400, TEW450		

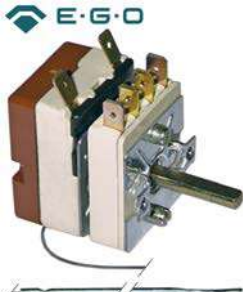

Part No.	375406	Ref. No.	355693
description	thermostat t.max. 110°C temperature range 30-110°C 1-pole 1CO 16A probe ø 6mm probe L 113mm capillary pipe 2380mm capillary pipe isolated 1700mm gland nut M9x1 shaft ø ø6x4.6mm shaft L 18mm shaft position upper rotation 270° outer switch 2NO		
For models:	FEH613, FEH615, FEH705, FEH715, FEW250, FEW252, FGH613, FGH615, LEH605, LEH703, LEH705, LEW450, LEW452, LGH605, LGH607, NEA182, NEH212, NEH613, NEH615, NEH705, NEW180, NEW182, NEW250, NEW252, NEW450, NEW452, NGH202, NGH603, NGH605, NGH607, NGH613, NGH615, NGH617, NGH723, NGH725, NGH727, NGH733, NGH737, PEW458, PEW658, SEW250, SEW400, SEW450, TEW250, TEW400, TEW450		

Part No.	375406	Ref. No.	355693
description	thermostat t.max. 110°C temperature range 30-110°C 1-pole 1CO 16A probe ø 6mm probe L 113mm capillary pipe 2380mm capillary pipe isolated 1700mm gland nut M9x1 shaft ø ø6x4.6mm shaft L 18mm shaft position upper rotation 270° outer switch 2NO		
For models:	FEH613, FEH615, FEH705, FEH715, FEW250, FEW252, FGH613, FGH615, LEH605, LEH703, LEH705, LEW450, LEW452, LGH605, LGH607, NEA182, NEH212, NEH613, NEH615, NEH705, NEW180, NEW182, NEW250, NEW252, NEW450, NEW452, NGH202, NGH603, NGH605, NGH607, NGH613, NGH615, NGH617, NGH723, NGH725, NGH727, NGH733, NGH737, PEW458, PEW658, SEW250, SEW400, SEW450, TEW250, TEW400, TEW450		



1

Part No.	375073	Ref. No.	174677
description	thermostat t.max. 320°C temperature range 50-320°C 1-pole capillary pipe isolatedmm gland nut		

accessories for	375406			
	Part No.	110545	Ref. No.	141091
	knob dial plate silver thermostat t.max. 110°C 30-110°C rotation 310° ED ø 59mm ID ø 45.5mm			
	Part No.	112173	Ref. No.	—
	knob universal ø 62mm black without adaptor/dial plate			



55.34_ series

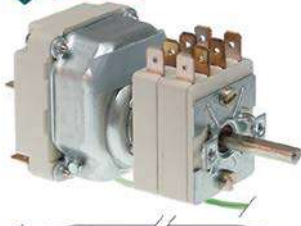

1

Part No.	375592	Ref. No.	540592
description	thermostat t.max. 110°C temperature range 32-110°C 3-pole 3NO 16A probe ø 6mm probe L 138mm capillary pipe 1180mm capillary pipe isolated 1100mm gland nut shaft ø 6x4.6mm shaft L 23mm shaft position upper rotation 270° outer switch 2NO/2NO		
For models:	EEW250, EEW450, EEW452		



1

Part No.	375023	Ref. No.	540511
description	thermostat t.max. 180°C temperature range 103-175/108-180°C 3-pole 2NO/2NO 16A probe ø 3.1mm probe L 305mm capillary pipe 720mm capillary pipe isolated 700mm gland nut shaft ø 6x4.6mm shaft L 23mm shaft position upper rotation 270° outer switch 2NO/2NO		
For models:	EEF124, EEF224		

various

safety thermostats



1

Part No.	390510	Ref. No.	943228002
description	safety thermostat with thermocouple		
For models:	EGF124, EGF224		

switches and momentary switches

push/momentary push switches

2 hole fixing



1

Part No.	345136	Ref. No.	407319
description	switch combination triple green 240V 16A connection male faston 6.3mm ambient temperature max. 125°C protection IP44		
For models:	ECD106, ECD110, ECD120, ECD220		

microswitches

universal



1

Part No.	345042	Ref. No.	183197
description	microswitch with plunger 250V 16A 1CO connection male faston 6.3mm L 28mm ambient temperature max. 125°C mounting distance 22mm type EF83161.3 actuating force: 75g blue/black		
For models:	ECL484		
accessories for	345042		
	Part No.	345043	Ref. No. —
lever set 5-piece			

lever actuated



1

Part No.	345254	Ref. No.	540575
description	microswitch with lever 250V 16A 1CO connection male faston 6.3mm ambient temperature max. 120°C mounting distance 22mm actuating force: 60g lever length 58mm		
For models:	EEF124, EEF224		



1

Part No.	345255	Ref. No.	781660004
description	microswitch with lever 250V 16A 1CO connection male faston 6.3mm L 35mm L1 28mm ambient temperature max. 125°C mounting distance 22mm actuating force: 136g lever length 27mm		
For models:	NEK040, NEK060, NEK080, NEK100, NEK150, NNK040, NNK060, NNK080, NNK100, NNK150		



1

Part No.	345107	Ref. No.	183426
description	microswitch with lever 250V 16A 1CO connection male faston 6.3mm L 98mm ambient temperature max. 125°C mounting distance 22mm actuating force: 30g lever length 90mm		
For models:	EGP500, FEK040, FEK060, FEK080, FEK100, FEK150, FNK040, FNK060, FNK080, FNK100, FNK150, NEK040, NEK060, NEK080, NEK100, NEK150, NEP060, NEP203, NEP303, NEP400, NEP600, NEP900, NGP900, NNK040, NNK060, NNK080, NNK100, NNK150, NTE182, PEK048, PEK068, PEK088, PEK108, PEK158, PNK048, PNK068, PNK088, PNK108, PNK158		





 <p>1</p>			
Part No.	346375	Ref. No.	994902006
description	microswitch with lever 250V 10A connection male faston 6.3mm ambient temperature max. 85°C		
For models:	NEP400, NEP600, NEP601, NEP900, NEP901, NGP400, NGP600, NGP900		



roller-lever actuated non-standard

 <p>1</p>			
Part No.	346507	Ref. No.	177161
description	microswitch with handle with a switch connection cable		
For models:	FEF170, FEF180, NEF176, PEF178, PEF188		



pin-plunger actuated

 <p>1</p>			
Part No.	345060	Ref. No.	540426
description	microswitch with plunger 250V 16A 1NO connection male faston 6.3mm ambient temperature max. 85°C mounting distance 22mm type BS1010 actuating force: 350g red stroke 9mm		

 <p>1</p>			
Part No.	345062	Ref. No.	177168
description	microswitch with plunger 250V 16A 1NO/1NC connection male faston 6.3mm ambient temperature max. 85°C mounting distance 22mm type BS1012 actuating force: 350g red stroke 8mm		
For models:	FEF124, FEF144, FEF144e, FEF224, FEF224e, PEF128, PEF148, PEF228, TEF124, TEF144, TEF224		

				
 <p>1</p>				
Part No.	345042	Ref. No.	183197	
description	microswitch with plunger 250V 16A 1CO connection male faston 6.3mm L 28mm ambient temperature max. 125°C mounting distance 22mm type EF83161.3 actuating force: 75g blue/black			
For models:	ECL484			
accessories for	345042			
	Part No.	345043	Ref. No.	—
	 <p>lever set 5-piece</p>			



<p>M12</p>			
 <p>1</p>			
Part No.	345138	Ref. No.	177160
description	microswitch with plunger mounting distance 25mm thread M12x1 thread L 12mm 250V 20A 1CO connection screw stroke 7mm L1 13mm ambient temperature max. 85°C type Z15G1307 actuating force: 250g		
For models:	CBE106, CBE106-VAR091, CBE110, CBE110-VAR091, CBE120, CBE120-VAR091, CBE220, CBE220-VAR091, CBG110, CBG120, CEC106, CEC110, CEC120, CEC220, CED106, CED110, CED120, CED220, CEF106, CEF110, CEF120, CEF220, CEM110, CEM120, CGD110, CGD120, EAB051, EDC106, FEP230, FEP330, NEP203, NEP303, PEP238, PEP338		

<p>M16</p>				
 <p>1</p>				
Part No.	345047	Ref. No.	407268	
description	microswitch with plunger thread M16x1 thread L 27mm 250V 5A 1NO connection cable stroke 5mm ambient temperature max. 85°C with cable type 837333 actuating force: 400g			
For models:	ECD106, ECD110, ECD120, ECD220			
accessories for	345047			
	Part No.	698490	Ref. No.	—
	 <p>cover ED ø 17mm suitable for 345047</p>			

position switches

<p>OMRON</p>			
 <p>1</p>			
Part No.	346299	Ref. No.	163611
description	position switch		
For models:	EEP500		

float switches

 <p>1</p>				
Part No.	400023	Ref. No.	407262	
description	float switch thread 3/8" 1CO ø 30mm L 170mm mounting ø 3/8"mm 250V 0.5A cable cable length 2000mm			
accessories for	400023			
	Part No.	506024	Ref. No.	—
	 <p>nut thread 3/8" H 6mm SS WS 22 Qty 1 pcs</p>			



cam switches

on/off





1

Part No.	300074	Ref. No.	540856
description	cam switch 4 operating positions 2NO sequence 0-1-0-1 16A shaft \varnothing 6x4.6mm shaft L 23mm connection male faston 6.3mm ceramic		



1

Part No.	300020	Ref. No.	182861
description	cam switch 4 operating positions 2NO sequence 0-1-0-1 16A shaft \varnothing 6x4.6mm shaft L 23mm connection screw ceramic		
For models:	EGS060, EHN601, EHP601, EWB101, EWB201, EWN401-mit-beheizterm-Schrankraum, NDD080, NDD150, NDD250, NDD300, NHD080, NHD150, NHD250, NHD300, NTE182		
accessories for	300020		
	Part No.	110135	Ref. No. —
	rosette knob up to \varnothing 52mm		
	Part No.	110231	Ref. No. —
	knob switch 0-1-0-1 t.max.°C \varnothing 50mm shaft \varnothing 6x4.6mm shaft flat upper black		

4-position



1

Part No.	300023	Ref. No.	183205
description	cam switch 4 operating positions 1NO/2CO sequence 0-1-2-3 16A shaft \varnothing 6x4.6mm shaft L 23mm connection screw 4-position ceramic		
For models:	EHN401, EHN402, EHN601, EHN602, EHN801, EHN802, FEH210, FEH410, FEH413, FEH415, FEH610, FEH613, FEH615, NEH210, NEH212, NEH410, NEH413, NEH415, NEH610, NEH613, NEH615, NEP060, PEH218, PEH418, PEH618		



1

Part No.	300103	Ref. No.	182752 183105
description	cam switch 4 operating positions 1NO/2CO sequence 0-1-2-3 32A shaft \varnothing 6x4.6mm shaft L 23mm connection screw ceramic		

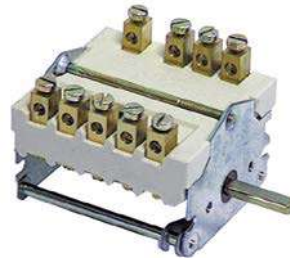

1

Part No.	300104	Ref. No.	540431
description	cam switch 4 operating positions 3NO/1CO sequence 0-1-2-3 32A shaft \varnothing 6x4.6mm shaft L 23mm connection screw ceramic		

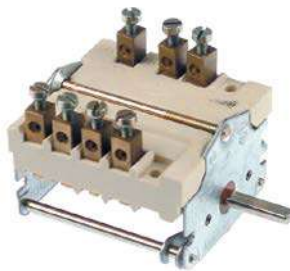

1

Part No.	300190	Ref. No.	540431 540472
description	cam switch 4-position sequence 0-3-2-1 shaft \varnothing 6x4.6mm connection screw clamp 3-pole		

7-position



1



Part No.	300004	Ref. No.	182774 183206
description	cam switch 7 operating positions 1NO/2CO sequence 0-1-2-3-4-5-6 16A shaft \varnothing 6x4.6mm shaft L 23mm connection male faston 6.3mm 7-position ceramic		
For models:	EHN401, EHN402, EHN601, EHN602, EHN801, EHN802		



E-G-O



1

Part No.	300025	Ref. No.	182774
description	cam switch 7 operating positions 1NO/2CO sequence 0-1-2-3-4-5-6 16A shaft ø 6x4.6mm shaft L 23mm connection screw 7-position ceramic		
For models:	EHP601, FEH210, FEH410, FEH413, FEH415, FEH610, FEH613, FEH615, LEH405, LEH605, NEH210, NEH212, NEH410, NEH413, NEH415, NEH610, NEH613, NEH615, PEH218, PEH418, PEH618, SEH200		
accessories for	300025		
	Part No.	112172	Ref. No. —
	knob universal ø 70mm black without adaptor/dial plate		
	Part No.	112213	Ref. No. —
	knob dial plate silver switch 7-position t.max.°C ED ø 63mm ID ø 45.5mm		
	Part No.	112311	Ref. No. —
	knob adapter shaft ø 6x4.6mm L 0mm with spring		

E-G-O

4 operating positions



1

Part No.	300185	Ref. No.	182728
description	cam switch 4 operating positions 2NO sequence 1-2-1-2 16A shaft ø 6x4.6mm shaft L 23mm connection male faston 6.3mm ceramic		
For models:	EDC106, FEF124, FEF144, FEF224, NDD080, NDD150, NDD250, NDD300, NED080, NED150, NED250, NED300, NHD080, NHD150, NHD250, NHD300, PEF128, PEF148, PEF228		

E-G-O



1

Part No.	300106	Ref. No.	183104
description	cam switch 7 operating positions 1NO/2CO sequence 0-1-2-3-4-5-6 32A shaft ø 6x4.6mm shaft L 23mm connection screw 7-position shaft flat upper		
For models:	EHO101, EHO111		

E-G-O



1

Part No.	300113	Ref. No.	183011
description	cam switch 4 operating positions 4NO sequence 0-1-0-2 32A shaft ø 6x4.6mm shaft L 23mm connection screw ceramic		
For models:	EES060, EES080, LES060, NED080, NED150, NED250, NED300, NEK040, NEK060, NEK080, NEK100, NEK150, NEM100, NER080, NER150, NER250, NER300, NER400, NER500, NES040, NES060, NES080, NES100, NES150, WES0400, WES0600, WES0800, WES1000, WES1500		

E-G-O

2 operating positions



1

Part No.	300112	Ref. No.	183232
description	cam switch 1NO sequence 0-1 10A shaft ø 6x4.6mm shaft L 23mm connection screw ON-OFF		
For models:	NED080, NED150, NED250, NED300, NEK040, NEK060, NEK080, NEK100, NEK150, NEM100, NER080, NER150, NER250, NER300, NER400, NER500, NES040, NES060, NES080, NES100, NES150, WES0400, WES0600, WES0800, WES1000, WES1500		

E-G-O



1

Part No.	300179	Ref. No.	183156
description	cam switch 4 operating positions 4NO/1CO sequence 0-1-0-2 32A shaft ø 6x4.6mm shaft L 23mm connection screw 0-1-0-2 ceramic		
For models:	LEF124, LEF224, NEF124, NEF144, NEF224, NEF244, SEF124, SEF144, SEF224, TEF124, TEF144, TEF224		



			
1			
Part No.	300019	Ref. No.	182746
description	cam switch 4 operating positions 4NO/1CO sequence 1-2-1-2 16A shaft \varnothing 6x4.6mm shaft L 23mm connection male faston 6.3mm ceramic		
For models:	FEH415, FEH505, FEH515, FEH615, FEH705, FEH715, FGH415, FGH615, LEH405, LEH505, LEH605, LEH705, LGH405, LGH605, NEH415, NEH505, NEH615, NEH705, NGH405, NGH415, NGH505, NGH605, NGH615, NGH725		

			
2			
Part No.	300211	Ref. No.	545500
description	cam switch 4 operating positions 8NO sequence 0-1-0-2 16A shaft \varnothing 6x4.6mm shaft L 18mm connection male faston 6.3mm		

			
1			
Part No.	300182	Ref. No.	163602
description	cam switch 4 operating positions sequence 0-1-0-2 shaft \varnothing 6x4.6mm connection male faston 4-pole		
For models:	NEP601, NEP901, NER080, NER150, NER250, NER300, NER400, NES040, NES060, NES080, NES100, NES150, NGR150, NGR250, NGR300, NGR400, NGS040, NGS060, NGS080, NGS100, NGS150, NNR080, NNR150, NNR250, NNR300, NNR400, NNS040, NNS060, NNS080, NNS100, NNS150		

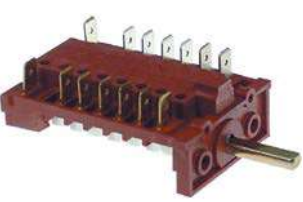
			
1			
Part No.	300193	Ref. No.	540445
description	cam switch sequence 0-1-0-2		



5 operating positions

			
1			
Part No.	300186	Ref. No.	540551
description	cam switch 16A		
For models:	EEW400		

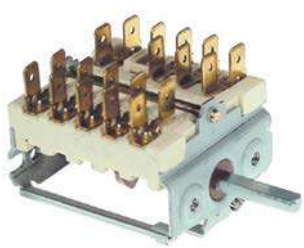
6 operating positions

			
1			
Part No.	301235	Ref. No.	183155
description	cam switch 6 operating positions sequence 0-1-2-3-4-5 shaft \varnothing 6x4.6mm connection male faston 4-pole		
For models:	ECL484		

operation switches

			
1			
Part No.	300080	Ref. No.	183110
description	cam switch 2 operating positions 4NO 16A sequence 0-1 shaft \varnothing 6x4.6mm shaft L 23mm connection screw operation switch ceramic ambient temperature max. 150°C		
For models:	NEF144		
accessories for	300080		
	Part No.	551456	Ref. No. —
	gasket for switch ED \varnothing 14mm ID \varnothing 2.5mm thickness 3.5mm white		

1

Part No.	300200	Ref. No.	540461
description	operation switch 2 operating positions 2NO 16A sequence 0-1 shaft \varnothing 6x4.6mm shaft L 23mm connection male faston 6.3mm operation switch ceramic		



1

Part No.	300091	Ref. No.	182825
description	operation switch EGO 2 operating positions 2NO 16A sequence 0-1 shaft \varnothing 6x4.6mm shaft L 23mm connection screw ceramic		
For models:	EAB051, FEF040, FEW252, NEB630, NEF176, NEW182, NEW250, NEW450		

magnetic switches

miscellaneous



1

Part No.	347235	Ref. No.	164891
description	magnetic switch 100V NC 5W brown mounting distance 16-18mm nominal 0.2A		



1

Part No.	347812	Ref. No.	164891
description	magnetic switch 100VDC 0.1A P max. 5W cable length 2000mm 1NC connection cable L 48mm 5W L1 12mm L2 11mm white mounting distance 16-18mm nominal 0.2A		
For models:	CCE106, CCE110, CCE120, CCE220, CPE106, CPE110, CPE120, CPE220		

control equipment

MOELLER/EATON

switches (complete)

push/momentary push switches



1

Part No.	346434	Ref. No.	540813	
description	momentary push switch mounting measurements \varnothing 22mm green complete 1NC/1NO on			
spare parts for	346434			
	Part No.	346293	Ref. No.	—
	contact block holder triple			
	Part No.	346436	Ref. No.	—
	button plate green I			
	Part No.	346747	Ref. No.	—
	push button mounting measurements \varnothing 22mm silver without button lense momentary illuminable			

GENERAL ELECTRIC (AEG)

push buttons



1

Part No.	345778	Ref. No.	163413
description	push button mounting measurements \varnothing 22mm illuminated red		
For models:	EGP500, PGP608, PGP908		



1

Part No.	345779	Ref. No.	163607
description	contact block GENERAL ELECTRIC P9B10VN 1NO max 400V 10A brown		
For models:	FEP600, FEP900, PEP608, PEP908, PGP608, PGP908		



1

Part No.	346322	Ref. No.	163614
description	contact block GENERAL ELECTRIC P9B20VN 2NO max 660V 10A red		
For models:	EEP500, EGP500		



lamp elements



1

Part No.	346412	Ref. No.	163006
description	indicator socket GENERAL ELECTRIC 187020 max 250V 0.01A red/ brown 2W socket Ba9s		
For models:	PGP608, PGP908		

rotary switches



1

Part No.	345781	Ref. No.	163608
description	rotary selector mounting measurements ø22mm black momentary sequence 1-0-2		
For models:	EEP500, EGP500, FEP600, FEP900, PEP608, PEP908, PGP608, PGP908		

accessories for	345781		
	Part No.	345779	Ref. No. 163607
	contact block GENERAL ELECTRIC P9B10VN 1NO max 400V 10A brown		



1

Part No.	346323	Ref. No.	163613
description	rotary selector mounting measurements ø22mm green latching sequence 1-0-2		
For models:	EEP500, EGP500		

SIEMENS

3SB series ø22mm old

rotary switches



1

Part No.	345782	Ref. No.	183411
description	rotary selector mounting measurements ø22mm sequence 1-0-2 momentary black		
For models:	NEK040, NEK060, NEK080, NEK100, NEK150, NEP060, NEP203, NEP303, NEP400, NEP600, NEP601, NEP900, NEP901, NGP400, NGP600, NGP900, NNK040, NNK060, NNK080, NNK100, NNK150		

lamps



1

Part No.	359606	Ref. No.	183914
description	neon light bulb socket Ba9s 220V 2W clear ø 10mm L 28mm		
For models:	PGP608, PGP908		

accessories for	359606		
------------------------	--------	--	--



Part No.	359832	Ref. No.	—
description	lamp socket mounting measurements ø16.2mm socket Ba9s connection male faston 6.3mm		



Part No.	359853	Ref. No.	—
description	lamp socket mounting measurements ø18.2mm socket Ba9s connection male faston 6.3mm		

encoders and potentiometers



1

Part No.	300196	Ref. No.	407325
description	potentiometer 0-150		
For models:	ECD110, ECD120, ECD220		

lamps

indicator lights

lamps

light bulbs



1

Part No.	359608	Ref. No.	407265
description	light bulb socket E14 10/15W 230V ø 16mm L 51mm lens L 31mm Qty 1 pcs		
For models:	ECD106, ECD110, ECD120, ECD220		

neon light bulbs



1

Part No.	359606	Ref. No.	183914
description	neon light bulb socket Ba9s 220V 2W clear ø 10mm L 28mm		
For models:	PGP608, PGP908		

accessories for	359606		
------------------------	--------	--	--



Part No.	359832	Ref. No.	—
description	lamp socket mounting measurements ø16.2mm socket Ba9s connection male faston 6.3mm		

Table continues overleaf





accessories for	359606		
	Part No.	359853	Ref. No. —
	lamp socket mounting measurements ø18.2mm socket Ba9s connection male faston 6.3mm		





Part No.	359600	Ref. No.	407269
description	neon light bulb socket E10 220V 0.35W clear ø 10mm L 28mm		
For models:	ECD106, ECD110, ECD120, ECD220		

accessories for	359600		
------------------------	--------	--	--

	Part No.	359060	Ref. No. —
	lamp socket mounting measurements ø16.2mm socket E10 connection screw		

	Part No.	359063	Ref. No. —
	lamp socket mounting measurements ø19.2mm socket E14 connection screw		

	Part No.	359064	Ref. No. —
	lamp socket mounting measurements ø22.3mm socket E14 connection screw 250/380V ambient temperature at 1W 100°C ambient temperature at 2W 85°C		

	Part No.	359685	Ref. No. —
	lamp socket mounting measurements ø16.2mm socket E10		

	Part No.	359832	Ref. No. —
	lamp socket mounting measurements ø16.2mm socket Ba9s connection male faston 6.3mm		

	Part No.	359853	Ref. No. —
	lamp socket mounting measurements ø18.2mm socket Ba9s connection male faston 6.3mm		

	Part No.	359988	Ref. No. —
	lamp socket mounting measurements ø30.5mm 250V connection F6.3 temp.-resist. 55°C E14		

indicator lights (complete)

ø10mm

with plug-in socket



Part No.	359036	Ref. No.	184145
description	indicator light ø 10mm clear 230V connection male faston 6.3mm Qty 1 pcs		
For models:	ECL484		



Part No.	359139	Ref. No.	184186
description	indicator light ø 10mm green 230V connection male faston 6.3mm Qty 1 pcs		
For models:	ECL484		

ø12mm

with screw socket

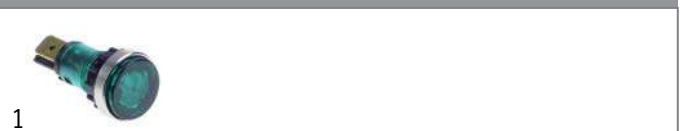

Part No.	359027	Ref. No.	540412
description	indicator light ø 12mm 250V green connection male faston 6.3mm		

ø16mm

with screw socket



Part No.	359835	Ref. No.	184120
description	indicator light ø 16mm 230V green connection male faston 6.3mm		

For models:	EAB051, ECL484, EDC106, EEB230, EEB430, EEF040, EEF124, EEF224, EEH210, EEH300, EEH410, EEH413, EEH500, EEH503, EEH610, EEH613, EEH700, EEH703, EEP500, EES060, EES080, EEW250, EEW400, EEW450, EEW452, EGH413, EGH613, EGP500, EGS060, EHO101, EHO111, FEB430, FEB630, FEF040, FEF124, FEF144, FEF224, FEH210, FEH410, FEH413, FEH415, FEH500, FEH503, FEH505, FEH510, FEH513, FEH515, FEH610, FEH613, FEH615...(Other models you can see in the web-shop)		
--------------------	---	--	--

accessories for	359835		
------------------------	--------	--	--

	Part No.	550559	Ref. No. —
	nut thread M16x1 H 5.5mm WS 19		

with plug-in socket



Part No.	359166	Ref. No.	184118
description	indicator light ø 16mm 230V white		

For models:	EAB051, ECL484, EDC106, EEF124, EEF224, EES060, EES080, EEW250, EEW450, EEW452, EGP500, FEF040, FEF124, FEF144, FEF224, FEH613, FEH615, FEH705, FEH715, FEP600, FEP900, FGH613, FGH615, LEB231, LEB270, LEB431, LEB631, LEF040, LEF124, LEF224, LEH405, LEH503, LEH505, LEH605, LEH703, LEH705, LEP400, LES060, LEW450, LEW452, LGH405, LGH605, LGH607, NDD080, NDD150, NDD250, NDD300, NEB430, NEB431, NEB630...(Other models you can see in the web-shop)		
--------------------	---	--	--



Part No.	359197	Ref. No.	184124 184265
description	indicator light ø 16mm 400V red		

For models:	EGN102, EGN401, EGN402, EGP202, EHN401, EHN601, EHN801, EPN402, EPP202, EWB101-mit-Thermostat, EWB201-mit-Thermostat, EWN101, EWN201, EWN401, EWN401-mit-beheizterm-Schrankraum, EWN402		
--------------------	---	--	--



 1			
Part No.	359198	Ref. No.	184125
description	indicator light ø 16mm 400V white		
For models:	EEB230, EEB430, EEH413, EEH503, EEH613, EEH703, EEP500, EGH413, EGH613, FEB430, FEB630, FEH413, FEH415, FEH503, FEH505, FEH513, FEH515, FEH613, FEH615, FEH705, FEH715, FEW250, FEW252, FGH413, FGH415, FGH613, FGH615, LEB270, LEB430, LEG420, LEH405, LEH503, LEH505, LEH605, LEH703, LEH705, LEP400, LES060, LEW450, LEW452, LGH405, LGH605, NEA182, NEB430, NEB630, NEF144, NEG420, NEH413, NEH415, NEH505...(Other models you can see in the webshop)		



 1			
Part No.	359169	Ref. No.	540623
description	indicator light ø 16mm 400V yellow		
For models:	EEW400		



miscellaneous

 1			
Part No.	359887	Ref. No.	407321
description	lamp socket socket E10 mounting measurements ø21mm		
For models:	ECD106, ECD110, ECD120, ECD220		

screw-on/push-on fit

neon light bulbs

 1			
Part No.	359606	Ref. No.	183914
description	neon light bulb socket Ba9s 220V 2W clear ø 10mm L 28mm		
For models:	PGP608, PGP908		
accessories for	359600		
	Part No.	359832	Ref. No. —
	lamp socket mounting measurements ø16.2mm socket Ba9s connection male faston 6.3mm		
	Part No.	359853	Ref. No. —
	lamp socket mounting measurements ø18.2mm socket Ba9s connection male faston 6.3mm		

 1			
Part No.	359600	Ref. No.	407269
description	neon light bulb socket E10 220V 0.35W clear ø 10mm L 28mm		
For models:	ECD106, ECD110, ECD120, ECD220		
accessories for	359600		
	Part No.	359060	Ref. No. —
	lamp socket mounting measurements ø16.2mm socket E10 connection screw		

accessories for	359600		
	Part No.	359063	Ref. No. —
	lamp socket mounting measurements ø19.2mm socket E14 connection screw		
	Part No.	359064	Ref. No. —
	lamp socket mounting measurements ø22.3mm socket E14 connection screw 250/380V ambient temperature at 1W 100°C ambient temperature at 2W 85°C		
	Part No.	359685	Ref. No. —
	lamp socket mounting measurements ø16.2mm socket E10		
	Part No.	359832	Ref. No. —
	lamp socket mounting measurements ø16.2mm socket Ba9s connection male faston 6.3mm		
	Part No.	359853	Ref. No. —
	lamp socket mounting measurements ø18.2mm socket Ba9s connection male faston 6.3mm		
	Part No.	359988	Ref. No. —
	lamp socket mounting measurements ø30.5mm 250V connection F6.3 temp.-resist. 55°C E14		

light bulbs

for ovens

 1			
Part No.	359610	Ref. No.	184001 407288
description	light bulb t.max. 300°C socket E14 15W 230V ø 22mm L 47mm lens L 20mm for oven lamp type Philips		
For models:	ECD106, ECD110, ECD120, ECD220, ECL484, EHP601		

 1			
Part No.	359612	Ref. No.	184018
description	light bulb t.max. 300°C socket E14 25W 230V ø 25mm L 56mm lens L 30mm for oven lamp type Philips		
For models:	ECL484		

 1			
Part No.	359611	Ref. No.	183926
description	light bulb t.max. 300°C socket E14 40W 230V ø 45mm L 75mm lens L 50mm for oven lamp IMPORT		
For models:	CEC106, CEC110, CEC120, CEC220, CED106, CED110, CED120, CED220		



for indicator lights



1			
Part No.	359608	Ref. No.	407265
description	light bulb socket E14 10/15W 230V ø 16mm L 51mm lens L 31mm Qty 1 pcs		
For models:	ECD106, ECD110, ECD120, ECD220		

halogen lamp

for socket G4 / G6.35 / G9



1			
Part No.	359599	Ref. No.	163000
description	halogen lamp socket G4 12V 20W temp.-resist. 500°C		
For models:	CBE106, CBE106-VAR091, CBE110, CBE110-VAR091, CBE120, CBE120-VAR091, CBE220, CBE220-VAR091, CBG110, CBG120, CCE106, CCE110, CCE120, CCE220, CEC106, CEC110, CEC120, CEC220, CED106, CED110, CED120, CED220, CEF106, CEF110, CEF120, CEF220, CEM110, CEM120, CGD110, CGD120, CPE106, CPE110, CPE120, CPE220		

linear lamps

infrared lamps

with base type R7s



1			
Part No.	359628	Ref. No.	163018
description	infrared lamp socket R7s L 117.6mm 240V 300W IMPORT unjacketed		

oven lamps

universal oven lamps

mounting diameter 35.5mm



1			
Part No.	359701	Ref. No.	407284
description	lamp socket socket E14 220-230V mounting ø 35.5mm connection male faston 6.3mm 15W		
For models:	ECD106, ECD110, ECD120, ECD220		
accessories for	359701		
	Part No.	359705	Ref. No.
			407390
	oven lamp glass thr.ø 33.5mm ø 52mm hard glas temp.-resist. 350°C		
	Part No.	359709	Ref. No.
			—
	oven lamp glass thr.ø 33.5mm ø 42mm hard glas temp.-resist. 350°C		
	Part No.	359721	Ref. No.
			407286
	gasket silicone ED ø 48mm ID ø 39.5mm thickness 5mm Qty 1 pcs		

accessories for	359701		
	Part No.	359942	Ref. No.
			—
	oven lamp glass thr.ø 33.5mm ø 41mm hard glas temp.-resist. 350°C		



1			
Part No.	359705	Ref. No.	407390
description	oven lamp glass thr.ø 33.5mm ø 52mm hard glas temp.-resist. 350°C		
For models:	ECD106, ECD110, ECD120, ECD220		

accessories for	359705		
	Part No.	359610	Ref. No.
			184001 407288
	light bulb t.max. 300°C socket E14 15W 230V ø 22mm L 47mm lens L 20mm for oven lamp type Philips		
	Part No.	359700	Ref. No.
			—
	gasket for pizza oven fibre glass ID ø 32.5mm ED ø 55mm thickness 5mm		
	Part No.	359721	Ref. No.
			407286
	gasket silicone ED ø 48mm ID ø 39.5mm thickness 5mm Qty 1 pcs		
	Part No.	359837	Ref. No.
			—
	gasket ID ø 33mm ED ø 46mm thickness 1mm graphite		
	Part No.	359838	Ref. No.
			—
	gasket ID ø 33mm ED ø 45mm		



1			
Part No.	359721	Ref. No.	407286
description	gasket silicone ED ø 48mm ID ø 39.5mm thickness 5mm Qty 1 pcs		
For models:	ECD106, ECD110, ECD120, ECD220		



mounting diameter 65.5mm



1			
Part No.	359712	Ref. No.	183927
description	oven lamp mounting ø 65.5mm 230V 40W socket E14 temp.-resist. 300°C connection male faston 6.3mm hard glas		
For models:	CEC106, CEC110, CEC120, CEC220, CED106, CED110, CED120, CED220		
spare parts for	359712		
	Part No.	359022	Ref. No.
			—
	lamp socket socket E14 mounting ø 65.5mm connection male faston 6.3mm		
	Part No.	359611	Ref. No.
			183926
	light bulb t.max. 300°C socket E14 40W 230V ø 45mm L 75mm lens L 50mm for oven lamp IMPORT		

Table continues overleaf



spare parts for		359712	
	Part No.	359722	Ref. No. 062339 062539
gasket silicone ID ø 57.5mm ED ø 68mm thickness 2mm			
	Part No.	359724	Ref. No. 407680
oven lamp glass thread ø 62mm H 46mm ø 74mm hard glas temp.-resist. 350°C			



Part No.	359724	Ref. No.	407680
description	oven lamp glass thread ø 62mm H 46mm ø 74mm hard glas temp.-resist. 350°C		
For models:	CEC106, CEC110, CEC120, CEC220, CED106, CED110, CED120, CED220		

55x70mm			
	1		
Part No.	359722	Ref. No.	062339 062539
description	gasket silicone ID ø 57.5mm ED ø 68mm thickness 2mm		
For models:	CEC106, CEC110, CEC120, CEC220, CED106, CED110, CED120, CED220		

55x70mm			
	1		
Part No.	359297	Ref. No.	131111
description	frame L 95mm W 81mm mounting distance 68/83mm thickness 6mm		
For models:	CBE106, CBE106-VAR091, CBE110, CBE110-VAR091, CBE120, CBE120-VAR091, CBE220, CBE220-VAR091, CBG110, CBG120, CCE106, CCE110, CCE120, CCE220, CEC106, CEC110, CEC120, CEC220, CED106, CED110, CED120, CED220, CEF106, CEF110, CEF120, CEF220, CEM110, CEM120, CGD110, CGD120, CPE106, CPE110, CPE120, CPE220		
accessories for	359297		

	Part No.	359299	Ref. No.	060323
gasket L 91mm W 77mm hole ø 3mm for oven lamp				

	1		
Part No.	359299	Ref. No.	060323
description	gasket L 91mm W 77mm hole ø 3mm for oven lamp		
For models:	CBE106, CBE106-VAR091, CBE110, CBE110-VAR091, CBE120, CBE120-VAR091, CBE220, CBE220-VAR091, CBG110, CBG120, CCE106, CCE110, CCE120, CCE220, CEC106, CEC110, CEC120, CEC220, CED106, CED110, CED120, CED220, CEF106, CEF110, CEF120, CEF220, CEM110, CEM120, CGD110, CGD120, CPE106, CPE110, CPE120, CPE220		

	1		
Part No.	359296	Ref. No.	103702
description	lamp glass L 74mm W 58mm thickness 3mm		
For models:	CBE106, CBE106-VAR091, CBE110, CBE110-VAR091, CBE120, CBE120-VAR091, CBE220, CBE220-VAR091, CBG110, CBG120, CCE106, CCE110, CCE120, CCE220, CEC106, CEC110, CEC120, CEC220, CED106, CED110, CED120, CED220, CEF106, CEF110, CEF120, CEF220, CEM110, CEM120, CGD110, CGD120, CPE106, CPE110, CPE120, CPE220		

60x100mm			
	1		
Part No.	359767	Ref. No.	184016 184017
description	oven lamp complete L 100mm W 60mm 230V 25W socket E14 temp.-resist. 300°C connection male faston 6.3mm		
For models:	ECL484		

lamps

light bulbs

	1		
Part No.	359610	Ref. No.	184001 407288
description	light bulb t.max. 300°C socket E14 15W 230V ø 22mm L 47mm lens L 20mm for oven lamp type Philips		
For models:	ECD106, ECD110, ECD120, ECD220, ECL484, EHP601		

	1		
Part No.	359612	Ref. No.	184018
description	light bulb t.max. 300°C socket E14 25W 230V ø 25mm L 56mm lens L 30mm for oven lamp type Philips		
For models:	ECL484		

	1		
Part No.	359611	Ref. No.	183926
description	light bulb t.max. 300°C socket E14 40W 230V ø 45mm L 75mm lens L 50mm for oven lamp IMPORT		
For models:	CEC106, CEC110, CEC120, CEC220, CED106, CED110, CED120, CED220		





halogen lamps			
for socket G4 / G6.35 / G9			
			
Part No.	359599	Ref. No.	163000
description	halogen lamp socket G4 12V 20W temp.-resist. 500°C		
For models:	CBE106, CBE106-VAR091, CBE110, CBE110-VAR091, CBE120, CBE120-VAR091, CBE220, CBE220-VAR091, CBG110, CBG120, CCE106, CCE110, CCE120, CCE220, CEC106, CEC110, CEC120, CEC220, CED106, CED110, CED120, CED220, CEF106, CEF110, CEF120, CEF220, CEM110, CEM120, CGD110, CGD120, CPE106, CPE110, CPE120, CPE220		

lamp accessories

gaskets			
			
Part No.	550891	Ref. No.	062304
description	gasket for lamp L 87mm W 66mm		
For models:	ECL484		

timers

programme timers

			
Part No.	360047	Ref. No.	120268
description	timer CDC 4905DV engines 2 chambers 5 operation time 4s / 150s 230V shaft ømm shaft Lmm manif. no. 4905DV / 360047 motor type M48L ATS		
spare parts for	360047		
	Part No.	360083	Ref. No. —
	motor CDC pinion ø 4.9mm teeth 10 230V turn direction left motor ø 47mm H 19.3mm motor type M48L ATS for timer		

electric timers

			
Part No.	350001	Ref. No.	174878 174946 355690 407267
description	timer 2CO at 250V 16A permanent position yes impulse electric shaft ø 6x4.6mm shaft L 22mm mounting distance 28mm connection rear 2-pole operation time 120min		
For models:	EAB051, EAB081, EAB101, EAB102, EAB112, ECD106, ECD110, ECD120, ECD220, ECL484		

with time spread

			
Part No.	350074	Ref. No.	174883
description	timer MS65 operation time 120min time spread 30min 1CO/2NO/1NC at 250V 16A permanent position yes impulse electric shaft ø 6x4.6mm shaft L 22mm mounting distance 28mm connection lateral Invensys 4-pole shaft position lower°		
For models:	CEC106, CEC110, CEC120, CEC220, CED106, CED110, CED120, CED220		

alarm devices

buzzers

			
Part No.	350050	Ref. No.	355612 407333
description	buzzer 230VAC connection male faston 6.3mm screw mounting thread M4 60dB		
For models:	CEC106, CEC110, CEC120, CEC220, CED106, CED110, CED120, CED220, ECL484, EDC106, NEP060, NEP203, NEP303, NTE182		



contactors

ABB

power contactors



1

Part No.	380092	Ref. No.	163519
description	power contactor resistive load 20A 230VAC (AC3/400V) 12A/5.5kW main contacts 4NO auxiliary contacts connection screw connection type B6-40-00 / B7-40-00		

GENERAL ELECTRIC (AEG)

power contactors



1

Part No.	380231	Ref. No.	185830 185850
description	power contactor resistive load 16A 230VAC (AC3/400V) 6A/3kW main contacts 3NO auxiliary contacts 1NC connection screw connection type AEG LS0701A		
For models:	CED106, CED110, EAB051, EDC106, NEP060, NEP600, NEP900		



1

Part No.	380239	Ref. No.	185830
description	power contactor resistive load 20A 230VAC (AC3/400V) 8.4A/4kW main contacts 3NO auxiliary contacts 1NC connection screw connection type LS05 01A type AEG LS05 01A type GE MC1A 301A		



1

Part No.	380337	Ref. No.	163500 185890
description	power contactor resistive load 20A 230VAC (AC3/400V) 8.4A/4kW main contacts 4NO auxiliary contacts connection screw connection type AEG LS05 400A type GE MC1A 400A		
For models:	CBE106, CBE106-VAR091, CBE110, CBE110-VAR091, CBE120, CBE120-VAR091, CCE106, CEC106, CEC110, CEC120, CEC220, CED106, CED110, CED120, CED220, CEF106, CEF110, CEF120, CEM110, CEM120, CPE106, ECL484, EES060, FEB430, FEB630, FED080, FED150, FED250, FEF124, FEF170, FEF180, FEF224, FEF224e, FEH415, FEH500, FEH503, FEH505, FEH510, FEH513, FEH515, FEH615, FEH700, FEH705, FEH710, FEH715, FEK040, FEK060, FEK080, FEK100, FEK150...(Other models you can see in the webshop)		



1

Part No.	380262	Ref. No.	185775 185783
description	power contactor resistive load 32A 230VAC (AC3/400V) 17A/7.5kW main contacts 3NO auxiliary contacts 1NC connection screw connection type AEG LS7K01A type GE CLO2A 301 H 85mm		
For models:	CBE110, CBE110-VAR091, CCE110, CEC106, CEC110, CED106, CED110, CEF110, CEM110, CPE110, EES080, FED080, FED250, FED300, FEF144, FEF144e, FEK080, FEK100, FEK150, FEP230, FER300, FER400, FES080, FES100, FES150, NEK040, NEK060, NEK080, NEK100, NEK150, NEP203, NEP303, NEP600, NEP900, NEP901, NER080, NER150, NER250, NER300, NER400, NER500, NES040, NES060, NES080, NES100, NES150, NTE182, PED088, PED258, PED308...(Other models you can see in the webshop)		



1

Part No.	380264	Ref. No.	185776 185796
description	power contactor resistive load 45A 230VAC (AC3/400V) 25A/11kW main contacts 3NO auxiliary contacts connection screw connection type AEG LS11K 00A type GE CL25A 300		
For models:	CBE120, CBE120-VAR091, CBE220, CBE220-VAR091, CEC120, CEC220, CED120, CED220, CEF120, CEF220, CEM120, FED150, FEK150, FEP330, FER150, FES150, NER150, NER300, NER400, NES150, PED158, PEK158, PEP338, PER158, PES158		



1

Part No.	380265	Ref. No.	185777 185797
description	power contactor resistive load 60A 230VAC (AC3/400V) 32A/16kW main contacts 3NO auxiliary contacts 1NO connection screw connection type AEG LS15K 00A type GE CL04A 310 H 98mm L 87mm W 55mm		
For models:	CCE120, CEC110, CED110, CPE120, FED250, FED300, FER250, NER250, PED258, PED308, PER258, PER308		



1

Part No.	380266	Ref. No.	186174
description	power contactor resistive load 90A 230VAC (AC3/400V) 22kW main contacts 3NO connection screw type AEG LS22K 00A type GE CL06A 300		
For models:	CBE120, CBE120-VAR091, CBE220, CBE220-VAR091, CCE220, CEC120, CEC220, CED120, CED220, CEF120, CEF220, CEM120, CPE220, FEF170, FEF180, FER300, FER400, NER300, NER400, PEF178, PEF188		

auxiliary contactors



1

Part No.	380277	Ref. No.	185778 185845
description	auxiliary contactor 230V		
For models:	CEC106, CEC110, CEC120, CEC220, CED120, CED220, EDC106, NEP060, NTE182		

motor protection circuit breakers



1

Part No.	380169	Ref. No.	407336
description	motor protection circuit breaker		
For models:	ECD106, ECD110		



1

Part No.	380170	Ref. No.	407332
description	motor protection circuit breaker		
For models:	ECD120, ECD220		

ISKRA (FANAL)

power contactors



1

Part No.	380212	Ref. No.	120461
description	power contactor resistive load 20A 230VAC (AC3/400V) 8.5A/5.5kW main contacts 3NO auxiliary contacts 1NC connection screw connection type Fanal K07M 01 type ISKRA DSL7 01		



MOELLER/EATON

power contactors



1

Part No.	380497	Ref. No.	185774 185798 185830 185844 540428
description	power contactor resistive load 20A 230VAC (AC3/400V) 9A/4kW main contacts 4NO auxiliary contacts connection screw connection type DILEM 4		
For models:	CBE106, CBE106-VAR091, CBE110, CBE110-VAR091, CBE120, CBE120-VAR091, CBE220, CBE220-VAR091, CBG110, CBG120, CEC106, CEC110, CEC120, CEC220, CED106, CED110, CED120, CED220, CEF106, CEF110, CEF120, CEF220, CEM110, CEM120, CGD110, CGD120, ECL484, FEF124, FEF144, FEF144e, FEF170, FEF180, FEF224, PEF128, PEF148, PEF178, PEF188, PEF228		



1

Part No.	380166	Ref. No.	407409
description	power contactor resistive load 40A 230VAC (AC3/400V) 25A/11kW main contacts 3NO auxiliary contacts 1NC connection screw connection type DILM25 01		
accessories for	380166		
	Part No.	Ref. No.	—
	auxiliary contact contacts 2NO/2NC AC15 16A for contactors DILEM connection screw type DILA-XHI22		
	Part No.	Ref. No.	—
	auxiliary contact contacts 4NO AC15 16A for contactors DILM 7-32 connection screw type DILA-XHI40		
	Part No.	Ref. No.	—
	auxiliary contact contacts 4NC AC15 16A for contactors DILM 7-32 connection screw type DILA-XHI04		
	Part No.	Ref. No.	—
	auxiliary contact contacts 3NO/1NC AC15 16A for contactors DILM 7-32 connection screw type DILA-XHI31		
	Part No.	Ref. No.	—
	auxiliary contact contacts 1NO/3NC AC15 16A for contactors DILM 7-32 connection screw type DILA-XHI13		
	Part No.	Ref. No.	—
	auxiliary contact contacts 1NO/1NC AC15 10A for contactors DIL 17-32 connection screw type DILM 32-CHI11-S		
	Part No.	Ref. No.	—
	RC circuit suitable for DILM 17-32 rated 110-240V		



1

Part No.	380167	Ref. No.	407331
description	power contactor resistive load 66A 230VAC (AC3/400V) 50A/22kW main contacts 3NO auxiliary contacts 1NO connection screw connection type DILM 50		

TELEMECANIQUE (Schneider Electric)

auxiliary contactors



1

Part No.	380367	Ref. No.	185780 185793 994853
description	auxiliary contactor 230VAC AC1 10A type CA2SK11P7 connection screw contacts 1NO/1NC		
For models:	FED080, FED150, FED250, FED300, FEH210, FEH410, FEH413, FEH415, FEH610, FEH613, FEH615, FEW250, FEW252, FGH413, FGH415, FGH613, FGH615, LEH503, LEH505, LEH703, LEH705, NEB431, NEP203, NEP303, NEP600, NEP900, NGH413, NGH415, NGH613, NGH615, NGH733, NTE182, PED088, PED158, PED258, PED308, PEH218, PEH418, PEH508, PEH518, PEH618, PEH708, PEH718, PEW458, PEW658		



1

Part No.	380188	Ref. No.	185780 185793 994853
description	small relay switch main contacts 1NO auxiliary contacts 1NC supply at 50-60Hz 220-240V		



ABL SURSUM

motor protection circuit breakers



1

Part No.	380300	Ref. No.	407528
description	motor protection circuit breaker type Mbs25-016 setting range 1-1.6A (AC3/400V) 0.55kW		
For models:	ECD106, ECD110		
accessories for	380300		
	Part No.	380305	Ref. No. 407529
	auxiliary contact contacts 1NO/1NC HMS11		



1

Part No.	380301	Ref. No.	407617
description	motor protection circuit breaker type Mbs25-025 setting range 1.6-2.5A (AC3/400V) 1.1kW		
For models:	ECD120, ECD220		

accessories



1

Part No.	380305	Ref. No.	407529
description	auxiliary contact contacts 1NO/1NC HMS11		
For models:	ECD106, ECD110, ECD120, ECD220		

miscellaneous

power contactors



1

Part No.	380165	Ref. No.	407330
description	power contactor		
For models:	ECD106, ECD110, ECD120, ECD220		

1

Part No.	380168	Ref. No.	407452
description	power contactor		

1

Part No.	380308	Ref. No.	407409
description	power contactor		
For models:	ECD110, ECD220		

1

Part No.	380289	Ref. No.	407452
description	power contactor resistive load 20A		
For models:	ECD106		



solid state relays

CELDUC





1

Part No.	401462	Ref. No.	164889
description	solid state relay CELDUC 1 phase 5A 600V 5-30VDC L 90mm W 12mm for top-hat rail screw type SKA20460		
For models:	CCE106, CCE110, CCE120, CCE220, CPE106, CPE110, CPE120, CPE220		



1

Part No.	401459	Ref. No.	164888	
description	solid state relay CELDUC 2 phase 50A 24-600V 6-16VDC L 59mm W 46mm screw type SOB965160			
For models:	CCE106, CCE110, CCE120, CCE220, CPE106, CPE110, CPE120, CPE220			
spare parts for	401459			
	Part No.	401676	Ref. No.	—
	heat-conducting foil L 57mm W 45mm			
accessories for	401459			
	Part No.	550802	Ref. No.	—
	PCB terminal block 4-pole raster size 5mm			

relays

power relays

with special fixing





1

Part No.	380309	Ref. No.	407331
description	power relays 230VAC 16A 2-pole		
For models:	ECD120, ECD220		

plug-in/print relays



1

Part No.	380500	Ref. No.	163502 163505 540352	
description	print relay 12VDC 2CO at 250V 8A connection pins raster size 5mm REIPOL			
For models:	EGP500			
accessories for	380500			
	Part No.	380340	Ref. No.	—
	relay socket dimensions 62x36x15mm 250V voltage AC 10A Italiana Relè manuf. no. ZMEM/5			
	Part No.	380505	Ref. No.	—
	relay socket 2CO 40.52 dimensions 81.9x15.5x75mm 250V voltage AC 10A FINDER manuf. no. 95.95.3			
	Part No.	381181	Ref. No.	—
	relay socket 2-pole 40.51/40.52/40.61 connection screw clamp dimensions 15.8x78.6mm 250V voltage AC 10A FINDER manuf. no. 95.75			

level relays

miscellaneous



1

Part No.	401256	Ref. No.	184833
description	level relay		
For models:	FED080, FED150, FED250, FED300, FGR150, FGR250, FGR300, FGR400, FGS040, FGS060, FGS080, FGS100, FGS150, NGR150, NGR250, NGR300, NGR400, PED088, PED158, PED258, PED308, PGS048, PGS068, PGS088		



1

Part No.	400070	Ref. No.	184824
description	level relay 1CO 230V voltage AC		
For models:	CED106, CED110, CED120, CED220		





1

Part No.	380345	Ref. No.	184824
description	level relay 1NC/1NO 230V voltage AC		

time relays

time relays



1

Part No.	380280	Ref. No.	407270
description	time relay WIELAND NGZ11 time range 1.5-30s 24-240V AC/DC 5A connection grip connection		
For models:	ECD106, ECD110, ECD120, ECD220		



1

Part No.	380282	Ref. No.	407271
description	time relay WIELAND NGZ310 time range 1.5-30s 24-240V AC/DC 5A connection grip connection		
For models:	ECD106, ECD110, ECD120, ECD220		

transformers

toroidal core transformers



1

Part No.	401466	Ref. No.	164712
description	transformer primary 230V secondary 2x12V 225VA		
For models:	EEP500, EGP500		

encapsulated transformers

multiple connections



1

Part No.	401143	Ref. No.	164700
description	transformer primary 230V secondary 9V 3.8VA		
For models:	FED080, FED150, FED250, FED300, FEF170, FEF180, FEK040, FEK060, FEK080, FEK100, FEK150, FEP230, FEP330, FEP610, FEP910, FER080, FER150, FER250, FER300, FER400, FES040, FES060, FES080, FES100, FES150, FGR150, FGR250, FGR300, FGR400, FGS040, FGS060, FGS080, FGS100, FGS150, FNK040, FNK060, FNK080, FNK100, FNK150, FNR080, FNR150, FNR250, FNR300, FNR400, NEP203, NEP303, NEP601, NEP901, NER080, NER150...(Other models you can see in the webshop)		

PMA



1

Part No.	379054	Ref. No.	407157
description	transformer primary 230VAC secondary 12VAC 3VA secondary 0.25A H 40mm L 45mm W 50mm connection screw 50/60Hz type 153/M		
For models:	NEF176, NEP203, NEP303		

for lighting



1

Part No.	400207	Ref. No.	164703
description	transformer L 110mm W 55mm H 33mm		
For models:	CBE106, CBE106-VAR091, CBE110, CBE110-VAR091, CBE120, CBE120-VAR091, CBE220, CBE220-VAR091, CBG110, CBG120, CEC106, CEC110, CEC120, CEC220, CED106, CED110, CED120, CED220, CEF106, CEF110, CEF120, CEF220, CEM110, CEM120, CGD110, CGD120		



1

Part No.	401460	Ref. No.	164710
description	transformer primary 230V secondary 11.5V 20W		
For models:	CCE106, CCE110, CPE106, CPE110		



miscellaneous

1

Part No.	400969	Ref. No.	164300 164700
description	transformer		

electronic controllers

OMRON

universal controllers

mounting measurements 45x45mm

1



Part No.	379055	Ref. No.	176593
description	electronic controller OMRON type E5C2-R40L-D mounting measurements 45x45mm 230V voltage AC TC/J 0 up to +200°C display analogue relay outputs 1 relay 3A TempIn1 yes two-position controller defr. funct. no		
For models:	CEC106, CEC110, CEC120, CEC220, EDC106, NDD080, NDD150, NDD250, NDD300, NED080, NED150, NED250, NED300, NHD080, NHD150, NHD250, NHD300		

SHANGFANG

accessories

1



Part No.	379054	Ref. No.	407157
description	transformer primary 230VAC secondary 12VAC 3VA secondary 0.25A H 40mm L 45mm W 50mm connection screw 50/60Hz type 153/M		
For models:	NEF176, NEP203, NEP303		

STÖRK-TRONIC

universal controllers

built-in version

1





Part No.	379304	Ref. No.	174403
description	electronic controller STÖRK-TRONIK type ST64-31.10 mounting measurements 60mm 230V voltage AC Pt100 relay outputs 1 NO-12A(6) Pt100 heated trolley front measurements 64mm built-in depth 62mm defr. funct. -80 to +400°C display 3 digits		
For models:	NDD080, NDD150, NDD250, NDD300, NED080, NED150, NED250, NED300, NHD080, NHD150, NHD250, NHD300		
accessories for	379304		
	Part No.	400040	Ref. No. —
	mounting plate SS dimensions 110x110mm cut-out ø 60mm		

refrigeration controllers

built-in version

1



Part No.	379304	Ref. No.	174403
description	electronic controller STÖRK-TRONIK type ST64-31.10 mounting measurements 60mm 230V voltage AC Pt100 relay outputs 1 NO-12A(6) Pt100 heated trolley front measurements 64mm built-in depth 62mm defr. funct. -80 to +400°C display 3 digits		
For models:	NDD080, NDD150, NDD250, NDD300, NED080, NED150, NED250, NED300, NHD080, NHD150, NHD250, NHD300		
accessories for	379304		
	Part No.	400040	Ref. No. —
	mounting plate SS dimensions 110x110mm cut-out ø 60mm		



electronic thermometers

built-in version



1	Part No.	379992	Ref. No.	176710
	description	thermometer mounting measurements 68.5x28.5mm -99 up to +199°C 12/24V voltage AC/DC measuring input Pt100 front measurements 72x36mm STÖRK-TRONIK type ST70-01.10		
	For models:	NEF176, NEP203, NEP303		
	accessories for	379992		
		Part No.	379054	Ref. No. 407157
		transformer primary 230VAC secondary 12VAC 3VA secondary 0.25A H 40mm L 45mm W 50mm connection screw 50/60Hz type 153/M		

miscellaneous

universal controllers



1	Part No.	379020	Ref. No.	407338
	description	electronic controller Pt100 steam control		
	For models:	ECD106, ECD110, ECD120, ECD220		



1	Part No.	400114	Ref. No.	161600
	description	electronic controller type Pt100		
	For models:	NEP203, NEP303, NEP601, NEP901, NER080, NER150, NER250, NER300, NER400, NES040, NES060, NES080, NES100, NES150, NGR150, NGR250, NGR300, NGR400, NGS040, NGS060, NGS080, NGS100, NGS150, NNR080, NNR150, NNR250, NNR300, NNR400, NNS040, NNS060, NNS080, NNS100, NNS150		
	accessories for	400114		
		Part No.	400119	Ref. No. 064300
		keypad foil tilting bratt pan NEP203/303/603 NER080/150/250/300		

probes

producer-specific probes

probes





1	Part No.	378656	Ref. No.	161639
	description	temperature probe 2xPt100 thread probe ø4x395mm cable length 510mm		

1		Part No.	379911	Ref. No.	161615
	description	temperature probe Pt100 cable glass fibre probe -100 up to 450°C cable -50 up to +350°C connection 2-wire thread probe ø4.6x13mm cable length 0.5m			
	For models:	FEF170, FEF180, NEP203, NEP303, NEP601, NEP901, PEF178, PEF188			

1		Part No.	379913	Ref. No.	995935002
	description	temperature probe Pt100 cable glass fibre probe -100 up to 450°C cable -50 up to +350°C connection 2-wire thread probe ø4.6x13mm cable length 0.5m			
	For models:	FEP230, FEP330, FEP610, FEP910, PEP238, PEP338, PEP618, PEP918			

1		Part No.	379168	Ref. No.	161608
	description	temperature probe Pt100 cable PTFE probe -100 up to 450°C cable -40 up to +250°C connection 2-wire thread M5 probe ø5x30mm cable length 2m			
	For models:	CBE106, CBE106-VAR091, CBE110, CBE110-VAR091, CBE120, CBE120-VAR091, CBE220, CBE220-VAR091, CBG110, CBG120, CCE120, CCE220, CEC106, CEC110, CEC120, CEC220, CED106, CED110, CED120, CED220, CEF106, CEF110, CEF120, CEF220, CEM110, CEM120, CGD110, CGD120, CPE120, CPE220			

1		Part No.	379912	Ref. No.	174465
	description	temperature probe Pt100 cable PTFE probe -100 up to 450°C cable -40 up to +250°C connection 2-wire thread probe ø6x440mm cable length 1.1m			
	For models:	FEF170, FEF180, NEF176, NEP203, NEP303, PEF178, PEF188			

1		Part No.	379399	Ref. No.	161601
	description	temperature probe Pt100 cable PVC probe -50 up to +200°C cable -10 up to 100°C connection 2-wire thread M10x1 probe ø10x10mm cable length 1.55m			
	For models:	FED080, FED150, FED250, FED300, FEK040, FEK060, FEK080, FEK100, FEK150, FEP230, FEP330, FER080, FER150, FER250, FER300, FER400, FES040, FES060, FES080, FES100, FES150, FGR150, FGR250, FGR300, FGR400, FGS040, FGS060, FGS080, FGS100, FGS150, FNK040, FNK060, FNK080, FNK100, FNK150, FNR080, FNR150, FNR250, FNR300, FNS040, FNS060, FNS080, FNS100, FNS150, NER080, NER150, NER250, NER300, NER400, NES040...(Other models you can see in the webshop)			

1		Part No.	379070	Ref. No.	407334 407339
	description	temperature probe Pt100 cable silicone probe -50 up to +250°C cable -50 up to +180°C connection 2-wire thread probe ø4x75mm cable length 1.7m			
	For models:	ECD106, ECD110, ECD120, ECD220			



1 electric components



Part No.	379999	Ref. No.	161633
description	temperature probe Pt1000 cable PTFE probe -70 up to +500°C cable -40 up to +250°C connection male faston 2.8mm thread M5x1 probe ø5x30mm cable length 0.1m		
For models:	CCE106, CCE110, CCE120, CCE220, CPE106, CPE110, CPE120, CPE220		

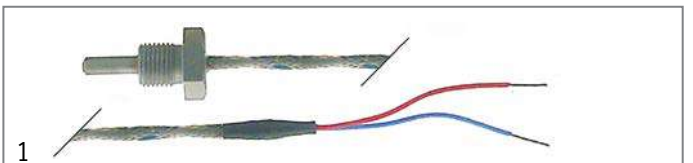

Part No.	379594	Ref. No.	174420
description	temperature probe thermocouple L (Fe-CuNi) cable Vetrotex probe -200 up to +700°C cable -50 up to +350°C connection 2-wire thread M10x1 probe ø4x13mm cable length 1.9m		
For models:	NDD080, NDD150, NDD250, NDD300, NED080, NED150, NED250, NED300, NHD080, NHD150, NHD250, NHD300		

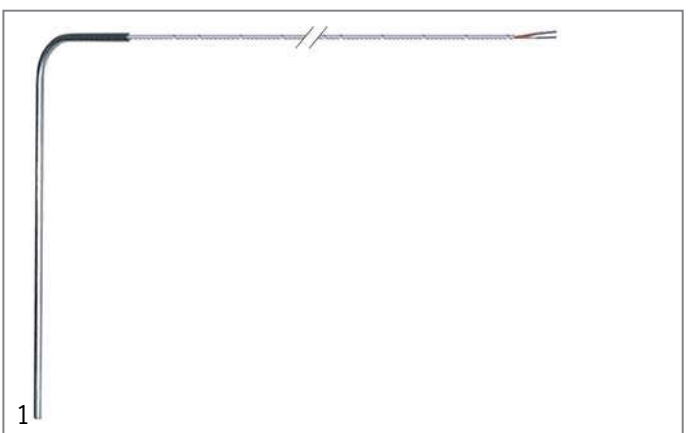

Part No.	379110	Ref. No.	174470
description	temperature probe thermocouple T (Cu-CuNi) cable Vetrotex probe -50 up to +750°C cable -50 up to +350°C connection 2-wire thread probe ø4x150/50mm cable length 1.5m		
For models:	CEC106, CEC110		

core probes

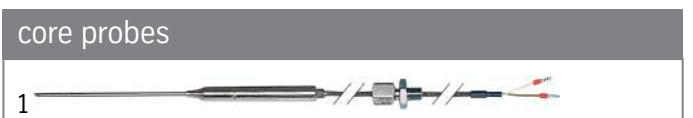

Part No.	379112	Ref. No.	407610
description	core temperature probe Pt100 cable PTFE probe -40 up to +250°C cable -40 up to +250°C connection 2-wire probe ø3.2x100mm thread M12 cable length 2.8m handle ø 10mm handle length 80mm		



Part No.	379898	Ref. No.	161628
description	core temperature probe Pt100 cable PTFE probe -40 up to +250°C cable -40 up to +250°C connection 2-wire probe ø4x100mm thread M9x1 cable length 2m handle ø 9mm handle length 45mm		
For models:	CBE106, CBE106-VAR091, CBE110, CBE110-VAR091, CBE120, CBE120-VAR091, CBE220, CBE220-VAR091, CBG110, CBG120		



Part No.	379109	Ref. No.	174461 174464 174464+060625 781897009
description	core temperature probe Pt100 cable PTFE probe -40 up to +250°C cable -40 up to +250°C connection 3-wire probe ø4x100mm thread M12 cable length 2.5m handle ø 9mm handle length 60mm		
For models:	CEC106, CEC110, CEC120, CEC220, CED106, CED110, CED120, CED220, CEF106, CEF110, CEF120, CEF220, CEM110, CEM120, CGD110, CGD120		



Part No.	379899	Ref. No.	161634 161642
description	core temperature probe Pt1000 cable thermoplastic probe -40 up to +250°C cable -40 up to +110°C connection 2-wire probe ø4x100mm thread M9x1 cable length 2m handle ø 9mm handle length 65mm		
For models:	CCE106, CCE110, CCE120, CCE220, CPE106, CPE110, CPE120, CPE220		

electronics

rectifiers



Part No.	401465	Ref. No.	163503
description	rectifier 250V 25A		
For models:	EEP500, EGP500		

PCBs



Part No.	401461	Ref. No.	161603 161630
description	control PCB combi-steamer CBE 106		
For models:	CBE106, CBE106-VAR091, CBE110, CBE110-VAR091, CBE120, CBE120-VAR091, CBE220, CBE220-VAR091, CBG110, CBG120, CEC106, CEC110, CEC120, CEC220, CED106, CED110, CED120, CED220, CGD110, CGD120		

1

Part No.	401468	Ref. No.	164885
description	display PCB combi-steamer CBE 106		
For models:	CCE106, CCE110, CCE120, CCE220		



1

Part No.	401444	Ref. No.	152428
description	keypad PCB		
For models:	FED080, FED150, FED250, FED300, FEP230, FEP330, PED088, PED158, PED258, PED308, PEP238, PEP338		



1

Part No.	401467	Ref. No.	164840 164896 564626
description	keypad PCB		



1

Part No.	400784	Ref. No.	164926
description	PCB		



1

Part No.	401481	Ref. No.	164884 165279
description	PCB		
For models:	CPE106, CPE110, CPE120, CPE220		

1

Part No.	401483	Ref. No.	407326
description	PCB		
For models:	ECD110, ECD120, ECD220		



1

Part No.	401484	Ref. No.	176717 176719
description	PCB		
For models:	CED106, CED110, CED120, CED220		

1

Part No.	401485	Ref. No.	161604
description	PCB		
For models:	CEF106, CEF110, CEF120, CEF220		

1

Part No.	401486	Ref. No.	161605
description	PCB		
For models:	CEM110, CEM120		



1

Part No.	400966	Ref. No.	152424 165287
description	PCB deep fryer/boiling pan FEF/FEK		
For models:	FEF144e, FEF170, FEF180, FEF224e, FEK040, FEK060, FEK080, FEK100, FEK150, FEP610, FEP910, FER080, FER150, FER250, FER300, FER400, FES040, FES060, FES080, FES100, FES150, FGR150, FGR250, FGR300, FGR400, FGS040, FGS060, FGS080, FGS100, FGS150, FNK040, FNK060, FNK080, FNK100, FNK150, FNR080, FNR150, FNR250, FNR300, FNR400, FNS040, FNS060, FNS080, FNS100, FNS150, PEF178, PEF188, PEK048, PEK068, PEK088...(Other models you can see in the webshop)		
accessories for	400966		
	Part No.	400967	Ref. No. 064305
	keypad foil		



1

Part No.	400411	Ref. No.	164883
description	PCB pyroceram range CH 40/45/80 230V		



1

Part No.	401476	Ref. No.	164890
description	power PCB		
For models:	CCE106, CCE110, CCE120, CCE220, CPE106, CPE110, CPE120, CPE220		



1

Part No.	401133	Ref. No.	152405
description	power PCB 230V		
For models:	TEB231, TEB431, TEB631		

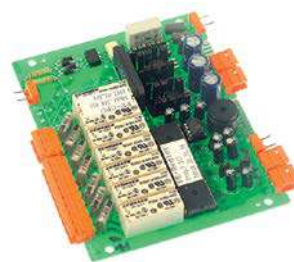

1

Part No.	400968	Ref. No.	164851
description	relay PCB		
For models:	FEF144e, FEF224e, FEK040, FEK060, FEK080, FEK100, FEK150, FEP610, FEP910, FER080, FER150, FER250, FER300, FER400, FES040, FES060, FES080, FES100, FES150, FGS040, FGS060, FGS080, FGS100, FGS150, FNK040, FNK060, FNK080, FNK100, FNK150, FNR080, FNR150, FNR250, FNR300, FNR400, FNS040, FNS060, FNS080, FNS100, FNS150, PED088, PED158, PED258, PED308, PEK048, PEK068, PEK088, PEK108, PEK158, PEP618, PEP918...(Other models you can see in the webshop)		



1

Part No.	401932	Ref. No.	164900
description	relay PCB fryer FEF_e		

central units



1

Part No.	401469	Ref. No.	164707
description	control box		
For models:	FEK040, FEK060, FEK080, FEK100, FEK150, NEP203, NEP303, NEP400, NEP600, NEP601, NEP900, NEP901, NGP400, NGP600, NGP900, PEK048, PEK068, PEK088, PEK108, PEK158, PEP238, PEP338, PEP608, PEP618, PEP908, PEP918, PNK048, PNK068, PNK088, PNK108, PNK158		



keypads

front foils



1

Part No.	400967	Ref. No.	064305
description	keypad foil		
For models:	FEF144e, FEF170, FEF180, FEF224e, FEK040, FEK060, FEK080, FEK100, FEK150, FEP610, FEP910, FNK040, FNK060, FNK080, FNK100, FNK150, PEF178, PEF188, PEK048, PEK068, PEK088, PEK108, PEK158, PEP618, PEP918, PGP618, PGP918, PNK048, PNK068, PNK088, PNK108, PNK158		



2

Part No.	400971	Ref. No.	064304
description	keypad foil 9 buttons L 160mm W 110mm		
For models:	FED080, FED150, FED250, FED300, FEP230, FEP330, PED088, PED158, PED258, PED308, PEP238, PEP338		



1

Part No.	400970	Ref. No.	064303
description	keypad foil L 160mm W 110mm		
For models:	FER080, FER150, FER250, FER300, FER400, FES040, FES060, FES080, FES100, FES150, FGR150, FGR250, FGR300, FGR400, FGS040, FGS060, FGS080, FGS100, FGS150, FNR080, FNR150, FNR250, FNR300, FNR400, FNS040, FNS060, FNS080, FNS100, FNS150, PER088, PER158, PER258, PER308, PES048, PES068, PES088, PES108, PES158, PGS048, PGS068, PGS088, PNR088, PNR158, PNR258, PNR308, PNS048, PNS068, PNS088, PNS108, PNS158		

membrane keypads



1

Part No.	101787	Ref. No.	064322
description	keypad foil		
For models:	FGH417, FGH507, FGH617, FGW250, PGB438		



1

Part No.	400119	Ref. No.	064300
description	keypad foil tilting bratt pan NEP203/303/603 NER080/150/250/300		
For models:	NEP203, NEP303, NEP601, NEP901, NER080, NER150, NER250, NER300, NER400, NES040, NES060, NES080, NES100, NES150, NGR150, NGR250, NGR300, NGR400, NGS040, NGS060, NGS080, NGS100, NGS150, NNR080, NNR150, NNR250, NNR300, NNR400, NNS040, NNS060, NNS080, NNS100, NNS150		

solenoïd valves

solenoïd valves (water)

MÜLLER

medium temperature: 90°C
duty cycle: 100%



1











Part No.	370004	Ref. No.	173121	
description	solenoid valve double straight 230VAC inlet 3/4" outlet 14.5mm DN10 t.max. 90°C duty cycle 100% MÜLLER			
For models:	CBE120, CBE120-VAR091, CBE220, CBE220-VAR091, CBG110, CBG120, CCE120, CCE220, CEC120, CEC220, CED120, CED220, CEF120, CEF220, CEM120, CGD110, CGD120, CPE120, CPE220, NTE182			
spare parts for	370004			
	Part No.	370129	Ref. No.	—
	solenoid valve body double straight inlet 3/4" outlet 14.5mm DN10 t.max. 90°C duty cycle 100% MÜLLER 230V			
	Part No.	371002	Ref. No.	—
	solenoid valve holder MÜLLER flange support			
	Part No.	371009	Ref. No.	—
	compression spring for solenoid coil			
	Part No.	371011	Ref. No.	—
	spare parts kit membrane with long star star hight 8mm MÜLLER			
	Part No.	371017	Ref. No.	—
	solenoid coil MÜLLER 230VAC connection male faston 6.3mm			
	Part No.	371122	Ref. No.	—
	solenoid valve filter ø 19mm H 10mm suitable for MÜLLER			
	Part No.	501161	Ref. No.	—
	tap head for solenoid valve holder for solenoid coils			
accessories for	370004			
	Part No.	371010	Ref. No.	407350
	solenoid coil 230VAC connection with cable cable length 2000mm			
	Part No.	371037	Ref. No.	—
	solenoid coil 24VAC 50/60Hz connection male faston 6.3mm			

Table continues overleaf

1 electric components





accessories for	370004		
	Part No.	371038	Ref. No. —
	solenoid coil 230VAC connection appliance plug		





Part No.	370117	Ref. No.	407352
description	solenoid valve single straight 230VAC inlet 3/4" outlet 11.5mm DN10 t.max. 90°C duty cycle 100% MÜLLER		

spare parts for	370117		
------------------------	--------	--	--

	Part No.	370133	Ref. No.	407597
	solenoid valve body single straight inlet 3/4" outlet 11.5mm DN10 t.max. 90°C duty cycle 100% MÜLLER 230V			

	Part No.	371002	Ref. No.	—
	solenoid valve holder MÜLLER flange support			

	Part No.	371009	Ref. No.	—
	compression spring for solenoid coil			

	Part No.	371011	Ref. No.	—
	spare parts kit membrane with long star star hight 8mm MÜLLER			

	Part No.	371017	Ref. No.	—
	solenoid coil MÜLLER 230VAC connection male faston 6.3mm			

	Part No.	371122	Ref. No.	—
	solenoid valve filter ø 19mm H 10mm suitable for MÜLLER			

	Part No.	501161	Ref. No.	—
	tap head for solenoid valve holder for solenoid coils			

accessories for	370117		
------------------------	--------	--	--

	Part No.	371010	Ref. No.	407350
	solenoid coil 230VAC connection with cable cable length 2000mm			

	Part No.	371037	Ref. No.	—
	solenoid coil 24VAC 50/60Hz connection male faston 6.3mm			

	Part No.	371038	Ref. No.	—
	solenoid coil 230VAC connection appliance plug			





Part No.	370002	Ref. No.	355635
-----------------	--------	-----------------	--------

description	solenoid valve single straight 230VAC inlet 3/4" outlet 14.5mm DN10 t.max. 90°C duty cycle 100% MÜLLER		
--------------------	--	--	--

For models:	CBE120, CBE120-VAR091, CBE220, CBE220-VAR091, CBG120, CCE120, CCE220, CEC120, CEC220, CED120, CED220, CEF120, CEF220, CEM120, CGD120, CPE120, CPE220, EAB051, EAB081, EAB101, EAB102, EAB112, EDC106, NDD080, NDD150, NDD250, NDD300, NED080, NED150, NED250, NED300, NHD080, NHD150, NHD250, NHD300		
--------------------	--	--	--

spare parts for	370002		
------------------------	--------	--	--

	Part No.	370127	Ref. No.	—
	solenoid valve body single straight inlet 3/4" outlet 14.5mm DN10 t.max. 90°C duty cycle 100% MÜLLER 230V			

	Part No.	371002	Ref. No.	—
	solenoid valve holder MÜLLER flange support			

	Part No.	371009	Ref. No.	—
	compression spring for solenoid coil			

	Part No.	371011	Ref. No.	—
	spare parts kit membrane with long star star hight 8mm MÜLLER			

	Part No.	371017	Ref. No.	—
	solenoid coil MÜLLER 230VAC connection male faston 6.3mm			

	Part No.	371122	Ref. No.	—
	solenoid valve filter ø 19mm H 10mm suitable for MÜLLER			

accessories for	370002		
------------------------	--------	--	--

	Part No.	371010	Ref. No.	407350
	solenoid coil 230VAC connection with cable cable length 2000mm			

	Part No.	371037	Ref. No.	—
	solenoid coil 24VAC 50/60Hz connection male faston 6.3mm			

	Part No.	371038	Ref. No.	—
	solenoid coil 230VAC connection appliance plug			

with cable connection

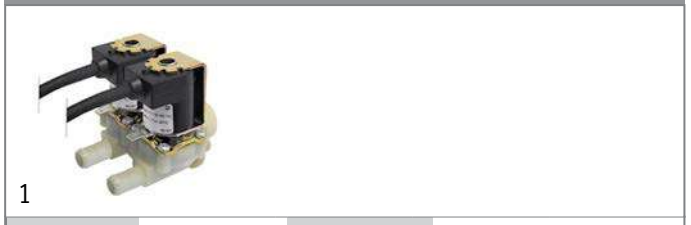

Part No.	370065	Ref. No.	407280
-----------------	--------	-----------------	--------

description	solenoid valve double straight 230VAC inlet 3/4" outlet 11.5mm DN10 t.max. 90°C duty cycle 100% MÜLLER cable length 2000mm		
--------------------	--	--	--

spare parts for	370065		
------------------------	--------	--	--

















	Part No.	370195	Ref. No.	—
	solenoid valve body double straight inlet 3/4" outlet 11.5mm DN10 t.max. 90°C duty cycle 100% MÜLLER 230V			











Table continues overleaf













spare parts for		370065	
Part No.	Ref. No.	Part No.	Ref. No.
	371002	—	—
solenoid valve holder MÜLLER flange support			
	371009	—	—
compression spring for solenoid coil			
	371010	407350	407350
solenoid coil 230VAC connection with cable cable length 2000mm			
	371011	—	—
spare parts kit membrane with long star star hight 8mm MÜLLER			
	371122	—	—
solenoid valve filter ø 19mm H 10mm suitable for MÜLLER			
	501161	—	—
tap head for solenoid valve holder for solenoid coils			
accessories for		370065	
Part No.	Ref. No.	Part No.	Ref. No.
	371017	—	—
solenoid coil MÜLLER 230VAC connection male faston 6.3mm			
	371037	—	—
solenoid coil 24VAC 50/60Hz connection male faston 6.3mm			
	371038	—	—
solenoid coil 230VAC connection appliance plug			

spare parts for		370065	
Part No.	Ref. No.	Part No.	Ref. No.
	370368	407352	407352
solenoid valve single straight 230VAC inlet 3/4" outlet 11.5mm DN10 t.max. 90°C duty cycle 100% MÜLLER cable length 2000mm			
description			
spare parts for		370368	
Part No.	Ref. No.	Part No.	Ref. No.
	370133	407597	407597
solenoid valve body single straight inlet 3/4" outlet 11.5mm DN10 t.max. 90°C duty cycle 100% MÜLLER 230V			
	371002	—	—
solenoid valve holder MÜLLER flange support			
	371009	—	—
compression spring for solenoid coil			
	371010	407350	407350
solenoid coil 230VAC connection with cable cable length 2000mm			
	371011	—	—
spare parts kit membrane with long star star hight 8mm MÜLLER			
	371122	—	—
solenoid valve filter ø 19mm H 10mm suitable for MÜLLER			
	501161	—	—
tap head for solenoid valve holder for solenoid coils			

accessories for		370368	
Part No.	Ref. No.	Part No.	Ref. No.
	371017	—	—
solenoid coil MÜLLER 230VAC connection male faston 6.3mm			
	371037	—	—
solenoid coil 24VAC 50/60Hz connection male faston 6.3mm			
	371038	—	—
solenoid coil 230VAC connection appliance plug			

spare parts for		370070	
Part No.	Ref. No.	Part No.	Ref. No.
	370070	173134	173134
solenoid valve single angled 230VAC inlet 3/4" outlet 14.5mm DN10 t.max. 90°C duty cycle 100% MÜLLER cable length 2000mm			
description			
For models:		CBE106, CBE106-VAR091, CBE110, CBE110-VAR091, CBG110, CCE106, CCE110, CEC106, CEC110, CED106, CED110, CEF106, CEF110, CEM110, CGD110, CPE106, CPE110	
spare parts for		370070	
Part No.	Ref. No.	Part No.	Ref. No.
	370126	—	—
solenoid valve body single angled inlet 3/4" outlet 14.5mm DN10 t.max. 90°C duty cycle 100% MÜLLER plastic			
	371002	—	—
solenoid valve holder MÜLLER flange support			
	371009	—	—
compression spring for solenoid coil			
	371010	407350	407350
solenoid coil 230VAC connection with cable cable length 2000mm			
	371011	—	—
spare parts kit membrane with long star star hight 8mm MÜLLER			
	371122	—	—
solenoid valve filter ø 19mm H 10mm suitable for MÜLLER			
	501161	—	—
tap head for solenoid valve holder for solenoid coils			
accessories for		370070	
Part No.	Ref. No.	Part No.	Ref. No.
	371017	—	—
solenoid coil MÜLLER 230VAC connection male faston 6.3mm			
	371037	—	—
solenoid coil 24VAC 50/60Hz connection male faston 6.3mm			
	371038	—	—
solenoid coil 230VAC connection appliance plug			



			
1			
Part No.	370369	Ref. No.	782582004
description	solenoid valve single angled 230VAC inlet 3/4" outlet 14.5mm DN10 t.max. 90°C duty cycle 100% MÜLLER cable length 2000mm		
spare parts for	370369		
	Part No.	370128	Ref. No. —
	solenoid valve body double angled inlet 3/4" outlet 14.5mm DN10 t.max. 90°C duty cycle 100% MÜLLER 230V double-ways		
	Part No.	371002	Ref. No. —
	solenoid valve holder MÜLLER flange support		
	Part No.	371009	Ref. No. —
	compression spring for solenoid coil		
	Part No.	371010	Ref. No. 407350
	solenoid coil 230VAC connection with cable cable length 2000mm		
	Part No.	371011	Ref. No. —
	spare parts kit membrane with long star star high 8mm MÜLLER		
	Part No.	371122	Ref. No. —
	solenoid valve filter ø 19mm H 10mm suitable for MÜLLER		
	Part No.	501161	Ref. No. —
	tap head for solenoid valve holder for solenoid coils		
accessories for	370369		
	Part No.	371017	Ref. No. —
	solenoid coil MÜLLER 230VAC connection male faston 6.3mm		
	Part No.	371037	Ref. No. —
	solenoid coil 24VAC 50/60Hz connection male faston 6.3mm		
	Part No.	371038	Ref. No. —
	solenoid coil 230VAC connection appliance plug		

spare parts and accessories

valve bodies

			
1			
Part No.	370137	Ref. No.	407351
description	solenoid valve body double outlet 11.5mm		
For models:	ECD106, ECD110, ECD120, ECD220		

			
1			
Part No.	370133	Ref. No.	407597
description	solenoid valve body single straight inlet 3/4" outlet 11.5mm DN10 t.max. 90°C duty cycle 100% MÜLLER 230V		
For models:	ECD106, ECD110, ECD120, ECD220		

solenoid coils

			
1			
Part No.	371010	Ref. No.	407350
description	solenoid coil 230VAC connection with cable cable length 2000mm		
For models:	ECD106, ECD110, ECD120, ECD220		

ROBERTSHAW/INVENSYS

medium temperature: 90°C 90°C 60°C
 ambient temperature: 60°C 25°C 60°C
 duty cycle: 40% 100% 100%

			
1			
Part No.	370371	Ref. No.	407280
description	solenoid valve double straight 230VAC inlet 3/4" outlet 11.5mm DN10 EATON (INVENSYS) cable length 2000mm		
For models:	ECD106, ECD110, ECD120, ECD220		

			
1			
Part No.	370370	Ref. No.	407352
description	solenoid valve single straight 230VAC inlet 3/4" outlet 11.5mm DN10 EATON (INVENSYS) cable length 2000mm		
For models:	ECD106, ECD110, ECD120, ECD220		



metal			
LUCIFER			
2-way			
121Z series			
			
1			
Part No.	370071	Ref. No.	173133
description	solenoid valve 2-ways 230VAC connection 1/8" DN 2.5mm slide-on receptacle DIN -20° up to 130°C LUCIFER-PARKER type series 121Z coil type DZ06S6 membranes FKM (water) p max 10bar		
For models:	CEC106, CEC110, CED106, CED110, FED080, FED150, FED250, FED300, PED088, PED158, PED258, PED308		
accessories for	370071		
	Part No.	371090	Ref. No. —
	power socket plug type DIN 43650A screw		

SIRAI			
solenoid valves steam (water)			
2-way			
L153-D series			
			
1			
Part No.	370079	Ref. No.	358119
description	solenoid valve 2-ways 230VAC connection 3/4" L 79mm DN 17mm slide-on receptacle DIN -10 up to 140°C SIRAI type series L153-D coil type Z134A membranes EPDM (steam/water) p max 8bar p min 0.1bar 50Hz		
For models:	FED080, FED150, FED250, FED300, FNR080, FNR150, FNR250, FNR300, FNR400, FNS040, FNS060, FNS080, FNS100, FNS150, NHS040, NHS060, NNR080, NNR150, NNR250, NNR300, NNR400, NNS040, NNS060, NNS080, NNS100, NNS150, NTE182, PED088, PED158, PED258, PED308, PNR088, PNR158, PNR258, PNR308, PNS048, PNS068, PNS088, PNS108, PNS158		
accessories for	370079		
	Part No.	371077	Ref. No. —
	solenoid coil 230VAC 24VA SIRAI coil type Z110A/Z114A/Z134A seat ø 14mm		

solenoid valves (gas)			
DUNGS			
			
1			
Part No.	106965	Ref. No.	173142
description	gas valve 230VAC DN 20mm connection 3/4" L 100mm DUNGS p max 0.36bar type MVD207/5 50/60Hz		
For models:	CBG110, CBG120, CGD110, CGD120, EGS060, NGS040, NGS060, NGS080, NGS100, NGS150		

ball valves electric			
			
1			
Part No.	401190	Ref. No.	120110 151006 164011 994595006 994898006 994899006
description	ball valve inlet 3/4" IT outlet 3/4" IT IP42 230V L 68mm 50/60Hz closed off-current mode of operation electric connection cable 300mm 3.5W duty cycle 50%		
For models:	CBE106-VAR091, CBE110-VAR091, CBE120-VAR091, CBE220-VAR091, CCE106, CCE110, CCE120, CCE220, CED106, CED110, CED120, CED220, CEF106, CEF110, CEF120, CEF220, CEM110, CEM120, CPE106, CPE110, CPE120, CPE220		

			
1			
Part No.	400208	Ref. No.	151006
description	ball valve mode of operation electric IT 3/4"		



pressure switches

for steam control



1

Part No.	541472	Ref. No.	151502
description	pressure control ø 45mm pressure connection vertical steam control connection male faston 6.3mm pressure connection ø 1/4"mm		



1

Part No.	541408	Ref. No.	540416
description	pressure control ø 45mm pressure range 450/300mbar pressure connection vertical steam control pressure range 0.45/0.3bar connection 1/4" pressure connection 1/4"		



1

Part No.	541016	Ref. No.	176197
description	pressure control ø 45mm pressure range 480/430mbar pressure connection vertical steam control pressure range 0.48/0.43bar connection 1/4" pressure connection 1/4"		
For models:	EES060, EES080, EGS060, FED080, FED150, FED250, FED300, FEK040, FEK060, FEK080, FEK100, FEK150, FEP230, FEP330, FER080, FER150, FER250, FER300, FER400, FES040, FES060, FES080, FES100, FES150, FGR150, FGR250, FGR300, FGR400, FGS040, FGS060, FGS080, FGS100, FGS150, NDD080, NDD150, NDD250, NDD300, NED080, NED150, NED250, NED300, NEK040, NEK060, NEK080, NEK100, NEK150, NEM100, NEP203, NEP303, NER080...(Other models you can see in the webshop)		



1

Part No.	541342	Ref. No.	151501
description	pressure control ø 45mm reset pressure reclosing lockbar pressure connection vertical steam control pressure range 0.6/0.54bar connection 1/4" pressure connection 1/4"		
For models:	FEK040, FEK060, FEK080, FEK100, FEK150, FER080, FER150, FER250, FER300, FER400, FES040, FES060, FES080, FES100, FES150, PEK048, PEK068, PEK088, PEK108, PEK158, PER088, PER158, PER258, PER308, PES048, PES068, PES088, PES108, PES158		

electrodes

1

Part No.	101785	Ref. No.	983811002
description	electrode		

1

Part No.	400072	Ref. No.	146440 983811002 988107006
description	level electrode push-in total length 100mm probe L 90mm insulated probe length 78mm connection F6.3 ø 6mm		
For models:	CBE106-VAR091, CCE106, CED106, CEF106, CPE106, FED080, FED150, FED250, FED300, FGR150, FGR250, FGR300, FGR400, NGR150, NGR250, NGR300, NGR400, PED088, PED158, PED258, PED308		

1

Part No.	400071	Ref. No.	984708002 988108006
description	level electrode push-in total length 170mm probe L 155mm insulated probe length 140mm connection F6.3 ø 5mm		
For models:	CBE110-VAR091, CBE120-VAR091, CBE220-VAR091, CCE110, CCE120, CCE220, CED110, CED120, CED220, CEF110, CEF120, CEF220, CEM110, CEM120, CPE110, CPE120, CPE220		

fans

cross flow fans

ebm-papst





1

Part No.	601146	Ref. No.	120111
description	cross flow fan QL4/0010-2112 roller ø 40mm roller length 100mm laminated core thickness 12mm motor position right 230V/50Hz 10W refrigeration bearing rubber connection male faston 6.3mm airflow 36m³/h 0 up to +60°C 230V 50Hz		
For models:	FGS040, FGS060, FGS080, FGS100, FGS150, NGS040, NGS060, NGS080, NGS100, NGS150, PGS048, PGS068, PGS088		



			
1			
Part No.	601297	Ref. No.	178415
description	cross flow fan QL4/2000 A6-2118L roller ø 40mm roller length 200mm laminated core thickness 18mm motor position right 230V/50Hz 17W refrigeration bearing rubber connection male faston 6.3mm airflow 80m³/h 0 up to +60°C 230V 50Hz		
For models:	EEH210, EEH300, EEH410, EEH413, EEH500, EEH503, EEH610, EEH613, EEH700, EEH703		

with moulded coils			
			
1			
Part No.	601456	Ref. No.	178352 178463
description	cross flow fan roller ø 45mm roller length 180mm laminated core thickness 15mm motor position right 230V/50Hz 26W universal bearing silicone connection male faston 6.3mm -30 up to +100°C 230V 50/60Hz		
For models:	EAB051, EDC106, FEH613, FEH615, FEH705, FEH715, FEW252, FGH613, FGH615, LEH503, LEH505, LEH703, LEH705, NEA182, NEH212, NEH615, NEH705, NEW182, NEW252, NEW452, NGH202, NGH605, NGH607, NGH615, NGH617, NGH725, NGH727, NGH737, NTE182		

COPREL			
with standard coil			
			
1			
Part No.	601101	Ref. No.	174259 174262
description	cross flow fan COPREL TFL(FN) roller ø 60mm roller length 300mm laminated core thickness 30mm motor position left 230V/50Hz 43W refrigeration bearing rubber connection male faston 6.3mm coil type airflow 268m³/h -10 up to +60°C		
For models:	CBE120, CBE120-VAR091, CBE220, CBE220-VAR091, CBG110, CBG120, CCE120, CCE220, CEC120, CEC220, CED120, CED220, CEF120, CEF220, CEM120, CGD120, CPE120, CPE220		

accessories for cross flow fans			
fasteners			
			
1			
Part No.	359654	Ref. No.	733294000
description	bracket for cross flow fan		
For models:	CBE120, CBE120-VAR091, CBE220, CBE220-VAR091, CBG120, CCE120, CCE220, CEC120, CEC220, CED120, CED220, CEF120, CEF220, CEM120, CGD120, CPE120, CPE220		

			
1			
Part No.	601453	Ref. No.	178410 178412
description	cross flow fan TFR 180 roller ø 60mm roller length 180mm laminated core thickness 16mm motor position right 230V/50-60Hz 17W universal bearing silicone connection male faston 6.3mm airflow 100m³/h -30 up to +100°C 230V 50Hz		
For models:	CBE106, CBE106-VAR091, CBE110, CBE110-VAR091, CBE120, CBE120-VAR091, CCE106, CCE110, CCE120, CEC106, CEC110, CEC120, CED106, CED110, CED120, CEF106, CEF110, CEF120, CEM110, CEM120, CGD110, CPE106, CPE110, CPE120, ECL484, FGR150, FGR250, FGR300, FGR400, NGR150, NGR250, NGR300, NGR400		
accessories for	601453		
	Part No.	415114	Ref. No. —
	 heater battery mounting distance 185mm W 40mm H 35mm 2000W 230V temperature restriction 105°C heating circuits 2 connection cable length 150mm L 192mm for cross flow fan		

heater battery			
			
1			
Part No.	415122	Ref. No.	402628
description	heater battery mounting distance 185mm W 40mm H 35mm 2000W 230V temperature restriction 105°C heating circuits 2 connection cable length 340mm L 197mm for cross flow fan		
For models:	FEH613, FEH615, FEH705, FEH715, FEW252, FGH613, FGH615, FGH617, NEA182, NEH212, NEH615, NEH705, NEW182, NEW252, NEW452, NGH202, NGH605, NGH607, NGH615, NGH617, NGH725, NGH727, NGH737		



hot air motors

1

Part No.	510534	Ref. No.	146144 754861000
description	clamping ring		
For models:	CEC106, CED106, FEH415, FEH505, FEH515, FEH615, FGH415, FGH615, NGH415, NGH615		



2

Part No.	510533	Ref. No.	146361 755770000
description	clamping ring for L9		
For models:	CEC110, CEC120, CEC220, CED110, CED120, CED220		

1

Part No.	693495	Ref. No.	146769
description	counterflange for fan motor ED \varnothing 60mm int. \varnothing 1 35mm int. \varnothing 2 26mm thickness 7mm brass		
For models:	CBE110, CBE110-VAR091, CBE120, CBE120-VAR091, CBE220, CBE220-VAR091, CBG110, CBG120, CCE110, CCE120, CCE220, CEC110, CEC120, CEC220, CED110, CED120, CED220, CEF110, CEF120, CEF220, CEM110, CEM120, CGD110, CGD120, CPE110, CPE120, CPE220		

accessories for 693495

	Part No.	510533	Ref. No.	146361 755770000
	description	clamping ring for L9		
	Part No.	510540	Ref. No.	146360 755769000
	description	gasket brass for fan motor ID \varnothing 23mm ED \varnothing 29.6mm		
	Part No.	510542	Ref. No.	062131
	description	gasket for fan motor ID \varnothing 42mm ED \varnothing 61mm thickness 1mm		

1

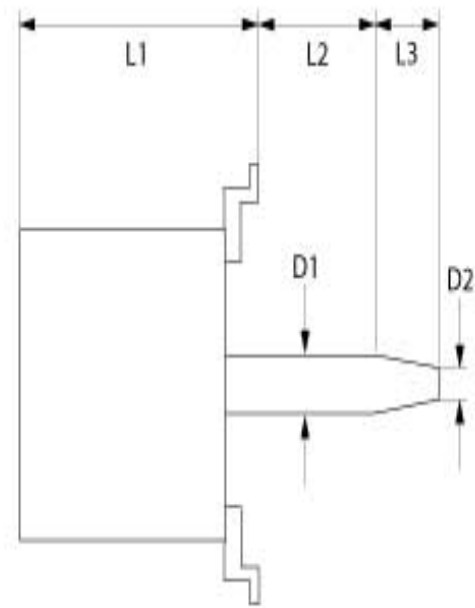

Part No.	500104	Ref. No.	120104
description	fan motor		
For models:	CBE106-VAR091, CED106, CEF106		

1

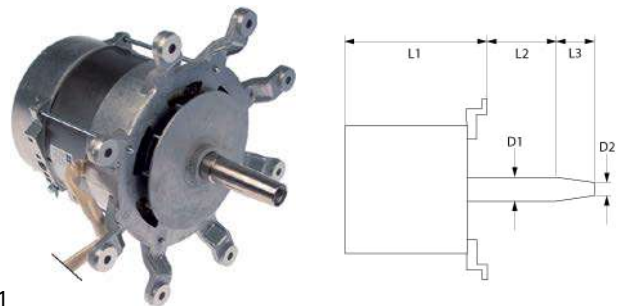

Part No.	500669	Ref. No.	120101 120117
description	fan motor		
For models:	CBG110, CBG120, CGD110, CGD120		

1

Part No.	501544	Ref. No.	115950
description	fan motor 220-240/380-415V 3 phase 50Hz 0.26/0.16kW 1440rpm L1 150mm L2 32mm L3 40mm M10R IT at 50Hz 1440rpm type L7zA-w4D-511 no. D6 D1 ø 17mm D2 ø 13mm mounting distance 180mm		
For models:	CBE106, CCE106, CEC106, CED106, CPE106, EAB051, ECD106, ECD110, ECD120, ECD220, EDC106		

1

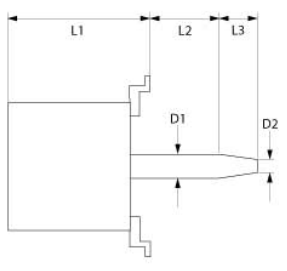
Part No.	500109	Ref. No.	115980 115989 120122
description	fan motor 220-240/380-415V 3 phase 50Hz 0.85kW 1360rpm speeds 1 L1 220mm L2 35mm L3 29mm M14L IT 4.3/2.5A power input 1170W Cos(fi) 0.71 at 50Hz 1360rpm type L9FG4D-160 no. X1 D1 ø 23mm D2 ø 20mm		
For models:	CBE220, CCE220, CEC220, CED220, CPE220		

1

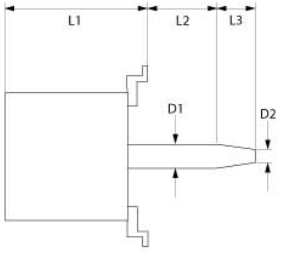
Part No.	601293	Ref. No.	120121
description	fan motor 220-240/380-415V 3 phase 50Hz 0.37kW 1400rpm speeds 1 L1 177mm L2 49mm L3 30mm M14R IT 2.85/1.65A power input 580W Cos(fi) 0.55 at 50Hz 1400rpm type L9Cw4D-037 D1 ø 23mm D2 ø 20mm		
For models:	CCE120, CPE120		



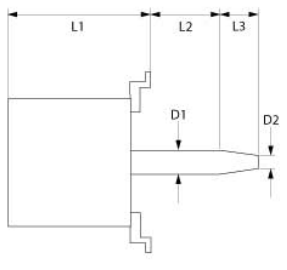

1

Part No.	500905	Ref. No.	120105
description	fan motor 380-415V 3 phase 50Hz 0.12/0.4kW 700/1350rpm speeds 2 L1 180mm L2 49mm L3 30mm M14R IT 0.55/1.0A power input 40/250W at 50Hz 700/1350rpm type L9Rw84b-285 D1 ø 23mm D2 ø 20mm		
For models:	CBE110-VAR091, CBE120-VAR091, CED110, CED120, CEF110, CEF120, CEM110, CEM120		



1

Part No.	601305	Ref. No.	115966
description	fan motor 220-240/380-415V 3 phase 50Hz 0.37kW 1410rpm speeds 1 L1 160mm L2 53mm L3 32mm D1 ø 23mm D2 ø 20mm M16R IT 1.6/0.92A Cos(fi) 0.8 at 50Hz 1410rpm		
For models:	CBE110, CBE120, CCE110, CCE120, CEC110, CEC120, CED110, CED120, CPE110, CPE120		
accessories for	601305		
	Part No.	560308	Ref. No. 151184
	hexagonal screw thread M16 thread L 20mm SS WS 24 Qty 1 pcs DIN 933 / ISO 4017		

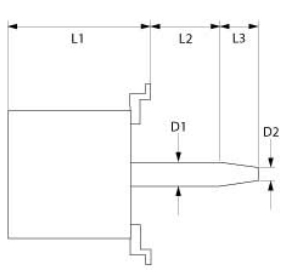
1

Part No.	500906	Ref. No.	120103
description	fan motor 380-415V 3 phase 50Hz 0.12/0.9kW 700/1380rpm speeds 2 L1 217mm L2 45mm L3 30mm M14R IT 0.9/2.1A power input 240/1200W at 50Hz 700/1380rpm Y/YY type L9zw84D-286 no. V1 D1 ø 23mm D2 ø 20mm		
For models:	CBE220-VAR091, CED220, CEF220		



1

Part No.	601302	Ref. No.	407289
description	fan wheel		

2

Part No.	601298	Ref. No.	174256
description	fan wheel D1 ø 280mm H1 115mm blades 42		
For models:	CBE106, CBE106-VAR091, CCE106, CEC106, CED106, CEF106, CPE106		

1

Part No.	601049	Ref. No.	407448
description	fan wheel D1 ø 280mm H1 125mm blades 12 D2 ø 11mm D3 ø 16mm H2 37mm		
For models:	ECD106		

1

Part No.	601311	Ref. No.	407289
description	fan wheel D1 ø 350mm H1 125mm blades 12 D2 ø 13mm D3 ø 16.5mm H2 37mm		
For models:	ECD110, ECD120, ECD220		



1

Part No.	601303	Ref. No.	174257
description	fan wheel D1 ø 355mm H1 127mm blades 42 D2 ø 20mm D3 ø 22mm H2 48mm		
For models:	CBE110, CBE110-VAR091, CBE120, CBE120-VAR091, CBG110, CBG120, CCE110, CCE120, CEC110, CEC120, CED110, CED120, CEF110, CEF120, CEM110, CEM120, CGD110, CGD120, CPE110, CPE120		

1

Part No.	601304	Ref. No.	174265
description	fan wheel D1 ø 400mm H1 127mm		
For models:	CBE220, CBE220-VAR091, CCE220, CEC220, CED220, CEF220, CPE220		

1

Part No.	510539	Ref. No.	146193 754860000
description	flange for fan motor ED ø 60mm int. ø 1 30mm int. ø 2 20mm thickness 3mm brass		
For models:	CBE106, CBE106-VAR091, CCE106, CEC106, CED106, CEF106, CPE106		

1

Part No.	693494	Ref. No.	146359 755768000
description	flange for fan motor ED ø 60mm int. ø 1 35mm int. ø 2 26mm thickness 6mm brass		
For models:	CEC110, CEC120, CEC220, CED110, CED120, CED220		

1

Part No.	510541	Ref. No.	146195 784863000
description	gasket brass for fan motor ID ø 17.3mm ED ø 25mm		
For models:	CBE106, CBE106-VAR091, CCE106, CEC106, CED106, CEF106, CPE106		



			
1			
Part No.	510537	Ref. No.	146194
description	gasket brass for fan motor ID ø 20mm ED ø 29.5mm		
For models:	CBE106, CBE106-VAR091, CCE106, CEC106, CED106, CEF106, CPE106		

			
1			
Part No.	510540	Ref. No.	146360 755769000
description	gasket brass for fan motor ID ø 23mm ED ø 29.6mm		
For models:	CBE110, CBE110-VAR091, CBE120, CBE120-VAR091, CBE220, CBE220-VAR091, CBG110, CBG120, CCE110, CCE120, CCE220, CEC110, CEC120, CEC220, CED110, CED120, CED220, CEF110, CEF120, CEF220, CEM110, CEM120, CGD110, CGD120, CPE110, CPE120, CPE220		

			
1			
Part No.	510542	Ref. No.	062131
description	gasket for fan motor ID ø 42mm ED ø 61mm thickness 1mm		
For models:	CBE106, CBE106-VAR091, CBE110, CBE110-VAR091, CBE120, CBE120-VAR091, CBE220, CBE220-VAR091, CBG110, CBG120, CCE106, CCE110, CCE120, CCE220, CEC106, CEC110, CEC120, CEC220, CED106, CED110, CED120, CED220, CEF106, CEF110, CEF120, CEF220, CEM110, CEM120, CGD110, CGD120, CPE106, CPE110, CPE120, CPE220		

hot air fans

ebm-papst

			
1			
Part No.	601294	Ref. No.	115971 115972 178413 178414 178464
description	hot air fan 230V 50W D 79mm distance fan wheel - fixing 10mm mounting distance 47mm ebm-papst type EM3038LH-20		
For models:	ECL484		

HANNING

			
1			
Part No.	601149	Ref. No.	174193
description	fan motor 230V L1 72mm L2 69mm L4 130mm HANNING type EMB-30-028		
For models:	FEH415, FEH505, FEH515, FEH615, FEH705, FEH715, FGH415, FGH615, NEH415, NEH505, NEH615, NEH705, NGH405, NGH415, NGH505, NGH605, NGH615, NGH725		

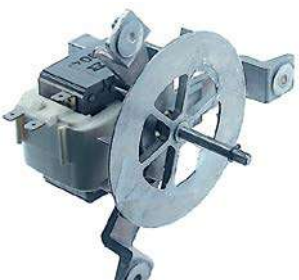
			
1			
Part No.	601008	Ref. No.	174192
description	hot air fan 230V 45W L1 72mm L2 28mm L4 130mm HANNING type EMB-30-027 M6L		
For models:	GHP601, LEH405, LEH505, LEH605, LEH705, LGH405, LGH605		

accessories

fan wheels for hot air fans

			
1			
Part No.	601196	Ref. No.	788878002
description	fan wheel ø 150mm W 20mm shaft intake ø 6x5mm blades 6		
For models:	ECL484, FEH415, FEH505, FEH515, FEH615, FEH705, FEH715, FGH415, FGH615, LEH405, LEH505, LEH605, LEH705, LGH405, LGH605, NEH415, NEH505, NEH615, NEH705, NGH405, NGH415, NGH505, NGH605, NGH615, NGH725		

			
1			
Part No.	601148	Ref. No.	174220
description	fan wheel ø 152mm W 20mm shaft intake ø 6x5mm stainless steel blades 6		
For models:	CEC106, CEC110, CEC120, CEC220, CGD110, CGD120, EHP601, GHP601, LGH405, LGH605		

miscellaneous			
1			
Part No.	500610	Ref. No.	120112
description	spindle motor		
For models:	NEP203, NEP303		

motors

gear motors

miscellaneous

			
1			
Part No.	500632	Ref. No.	115975
description	gear motor type MS56A/4 90/100W 230/400V 50/60Hz 19/23rpm shaft ø 12mm L 275mm W 110mm H 160mm for kettle		
For models:	NEK040, NEK060, NEK080, NEK100, NEK150, NNK040, NNK060, NNK080, NNK100, NNK150		

			
1			
Part No.	500611	Ref. No.	120116
description	spindle motor		
For models:	EEP500, EGP500		

spindle motors

MAGNETIC

			
1			
Part No.	500609	Ref. No.	120106
description	spindle motor type MAX30-120-0050 24V voltage DC shaft ø 28mm for tilting bratt pan L 335mm W 115mm H 180mm MAGNETIC		
For models:	FEP230, FEP330, NEP400, NEP600, NEP601, NEP900, NEP901, NGP400, NGP600, NGP900, PEP238, PEP338, PEP608, PEP618, PEP908, PEP918		

condensators & interference suppression filters

filters

RC circuits

			
1			
Part No.	380177	Ref. No.	407290
description	RC circuit type 20002 110/220V 50/60/DChz conductor 2 connection cable 230mm L 29mm ømm H 15mm W 20mm adhesive tape plastic Qty 1 pcs		
For models:	ECD106, ECD110, ECD120, ECD220		

			
1			
Part No.	500622	Ref. No.	120114
description	spindle motor type MAX30-120-0050 24V voltage DC shaft ø 29mm for kettle L 340mm W 120mm H 175mm MAGNETIC		
For models:	FEK040, FEK060, FEK080, FEK100, FEK150, FNK040, FNK060, FNK080, FNK100, FNK150, PEK048, PEK068, PEK088, PEK108, PEK158, PNK048, PNK068, PNK088, PNK108, PNK158		

fuses

fine fuses

			
1			
Part No.	358696	Ref. No.	216325
description	fine fuse size ø5x20mm 4A medium lag rated 250V Qty 10 pcs		
For models:	CBE106, CBE106-VAR091, CBE110, CBE110-VAR091, CBE120, CBE120-VAR091, CBE220, CBE220-VAR091, CBG110, CBG120, CCE106, CCE110, CCE120, CCE220, CEC106, CEC110, CEC120, CEC220, CED106, CED110, CED120, CED220, CEF106, CEF110, CEF120, CEF220, CEM110, CEM120, CGD110, CGD120, CPE106, CPE110, CPE120, CPE220, EAB051, EEH410, EEH413, EEH500, EEH503, EEH610, EEH613, EEH700, EEH703, EES060, EES080, FEB430, FEB630, FED080, FED150, FED250...(Other models you can see in the webshop)		



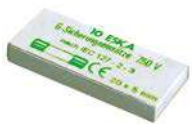

			
1			
Part No.	358598	Ref. No.	407274
description	fine fuse size \varnothing 5x20mm 0.63A slow-acting rated 250V Qty 10 pcs		
For models:	ECD106, ECD110, ECD120, ECD220		

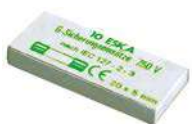
			
1			
Part No.	358608	Ref. No.	216327
description	fine fuse size \varnothing 5x20mm 10A slow-acting rated 250V Qty 10 pcs		
For models:	CEC106, CEC110, CEC120, CEC220, CED120, CED220		

			
1			
Part No.	358607	Ref. No.	407273
description	fine fuse size \varnothing 5x20mm 6.3A slow-acting rated 250V Qty 10 pcs		
For models:	ECD106, ECD110, ECD120, ECD220		

fine fuse holders

			
1			
Part No.	358508	Ref. No.	184683
description	fuse holder suitable fuse \varnothing 5x25mm		

			
1			
Part No.	550669	Ref. No.	184683
description	fuse holder suitable fuse \varnothing 5x25mm 10A rated 600V		
For models:	CBE106, CBE106-VAR091, CBE110, CBE110-VAR091, CBE120, CBE120-VAR091, CBE220, CBE220-VAR091, CBG110, CBG120, CCE106, CCE110, CCE120, CCE220, CEC106, CEC110, CEC120, CEC220, CED106, CED110, CED120, CED220, CEF106, CEF110, CEF120, CEF220, CEM110, CEM120, CGD110, CGD120, CPE106, CPE110, CPE120, CPE220, EEH410, EEH413, EEH500, EEH503, EEH610, EEH613, EEH700, EEH703, EEP500, EES060, EES080, EGP500, FEB430, FEB630, FED080, FED150...(Other models you can see in the webshop)		

			
1			
Part No.	550105	Ref. No.	407334
description	rail-mounted terminal WIELAND type WK10/SIU 5X20 /VO suitable fuse \varnothing 5x20mm 1.0-16mm ² 10A rated 250V		
For models:	ECD106, ECD110, ECD120, ECD220		

screw locks

D0-system (NEOZED)

			
1			
Part No.	358045	Ref. No.	407502
description	fuse size D02 35A rated 250/400V E18 \varnothing 15mm L 36mm Qty 10 pcs		
For models:	ECD220		

			
1			
Part No.	358046	Ref. No.	407503
description	fuse size D02 50A rated 250/400V E18 \varnothing 15mm L 36mm Qty 10 pcs		
For models:	ECD220		

gauge pieces (NEOZED)

			
1			
Part No.	358067	Ref. No.	407650
description	gauge piece size D02 suitable for 35A		
For models:	ECD220		

			
1			
Part No.	358068	Ref. No.	407649
description	gauge piece size D02 suitable for 50A		
For models:	ECD220		

fuse holders

			
1			
Part No.	358060	Ref. No.	407500
description	fuse holder suitable fuse D02 3-pole-pole 63A rated 400V		
For models:	ECD220		



			
1			
Part No.	358061	Ref. No.	407501
description	fuse holder suitable fuse D02 ø 25mm mounting ø 18mm rated 400V L 30mm		
For models:	ECD220		

electric accessories

cables

accessories

cable glands

threaded cable glands

screw connections

			
1			
Part No.	550319	Ref. No.	186249
description	cable gland thread PG7		
For models:	CED106, CED110, CED120, CED220		

terminals and connectors

not insulated

female fastons with piggyback

			
1			
Part No.	550055	Ref. No.	184721
description	male faston size 6.3x0.8mmmm ² with piggyback CuZn gal Sn t.max. 110°C Qty 1 pcs		

plug connectors

			
1			
Part No.	550330	Ref. No.	185821
description	plug connector 12-pole		
For models:	CEC106, CEC110, CEC120, CEC220, CED106, CED110, CED120, CED220, TEF224		

			
1			
Part No.	550333	Ref. No.	185817
description	plug connector 12-pole		
For models:	CEC106, CEC110, CEC120, CEC220, CED106, CED110, CED120, CED220, TEF224		

			
1			
Part No.	550888	Ref. No.	185818
description	plug connector 8-pole		
For models:	CEC106, CEC110, CEC120, CEC220, CED106, CED110, CED120, CED220, TEB231, TEB431, TEB631, TEF124, TEF144, TEF224, TEF400, TEH300, TEW250, TEW400, TEW450		

			
1			
Part No.	550889	Ref. No.	185822
description	plug connector 8-pole		
For models:	CEC106, CEC110, CEC120, CEC220, CED106, CED110, CED120, CED220, TEB231, TEB431, TEB631, TEF124, TEF144, TEF224, TEF400, TEH300, TEW250, TEW400, TEW450		

terminals

rail-mounted terminals

WIELAND

rail-mounted terminals type 9700A

			
1			
Part No.	550374	Ref. No.	407450 407456
description	rail-mounted terminal WIELAND type 9700A/10 S35 1.5-16mm ² top-hat rail 35mm blue W 10mm L 49mm		
For models:	ECD106, ECD110		

			
1			
Part No.	550373	Ref. No.	407345
description	rail-mounted terminal WIELAND type 9700A/10 S35 1.5-16mm ² top-hat rail 35mm grey W 10mm L 49mm		
For models:	ECD106, ECD110, ECD220		



 <p>1</p>			
Part No.	550375	Ref. No.	407346
description	rail-mounted terminal WIELAND type 9700A/10 SL2 S35 1.5-16mm ² top-hat rail 35mm yellow/green W 10mm L 53mm		
For models:	ECD106, ECD110		

 <p>1</p>			
Part No.	550377	Ref. No.	407485
description	rail-mounted terminal WIELAND type 9700A/16 S35 2.5-35mm ² top-hat rail 35mm blue W 16mm L 59mm		
For models:	ECD120		

 <p>1</p>			
Part No.	550376	Ref. No.	407484
description	rail-mounted terminal WIELAND type 9700A/16 S35 2.5-35mm ² top-hat rail 35mm grey W 16mm L 59mm		
For models:	ECD120		

 <p>1</p>			
Part No.	550378	Ref. No.	407486
description	rail-mounted terminal WIELAND type 9700A/16 SL2 S35 2.5-35mm ² top-hat rail 35mm yellow/green W 16mm L 53mm		
For models:	ECD120		

fuse terminal blocks

 <p>1</p>			
Part No.	550105	Ref. No.	407334
description	rail-mounted terminal WIELAND type WK10/SIU 5X20 /V0 suitable fuse ø5x20mm 1.0-16mm ² 10A rated 250V		
For models:	ECD106, ECD110, ECD120, ECD220		

accessories			
 <p>1</p>			
Part No.	550337	Ref. No.	407618
description	end barrier for fuse terminal clampsmm ²		
For models:	ECD120, ECD220		

 <p>1</p>			
Part No.	550370	Ref. No.	407533
description	terminal block end bracket clampsmm ²		
For models:	ECD106, ECD110, ECD120, ECD220		

electronic magnets

 <p>1</p>			
Part No.	401463	Ref. No.	162200
description	lifting magnet		
For models:	CBE106, CBE106-VAR091, CBE110, CBE110-VAR091, CBE120, CBE120-VAR091, CBE220, CBE220-VAR091, CBG110, CBG120, CCE106, CCE110, CCE120, CCE220, CEC106, CEC110, CEC120, CEC220, CED106, CED110, CED120, CED220, CEF106, CEF110, CEF120, CEF220, CEM110, CEM120, CGD110, CGD120, CPE106, CPE110, CPE120, CPE220		

gas taps

PEL

21S series







 <p>1</p>			
Part No.	101671	Ref. No.	150127 150128 406998
description	gas tap PEL type 21S gas inlet pipe flange ø21mm bypass nozzle ø 0.35mm gas outlet M17x1 (tube ø 10mm) thermocouple connection M8x1 pilot connection M10x1 shaft ø 6x4.6mm shaft L 30/23mm shaft flat upper		
For models:	EGH210, EGH410, EGH413, EGH417, EGH610, EGH613, EGH617		
spare parts for	101671		
	Part No.	100408	Ref. No. —
	 bypass nozzle type PEL20/21 bore ø 0.35mm thread M5x0.5		
	Part No.	100908	Ref. No. —
	 union screw thread M10x1 for pipe ø 4mm Qty 1 pcs		



Table continues overleaf











spare parts for		101671	
	Part No.	101060	Ref. No. 407088
	magnet unit standard L 39mm D1 ø 15.4mm D2 ø 11mm suitable for PEL20-21/JUNKERS/EGA		
	Part No.	101230	Ref. No. —
	thermocouple nut T1: M8x1 T2: M18x1 aluminium		
	Part No.	101246	Ref. No. —
	olive for pipe ø 4mm Qty 1 pcs		
	Part No.	101803	Ref. No. —
	gas tap front part shaft ø 6x4.6mm shaft L 30/23mm shaft flat upper/lower suitable for PEL21		

accessories for		101671	
	Part No.	100909	Ref. No. —
	union screw thread M10x1 for pipe ø 6mm Qty 1 pcs		
	Part No.	101278	Ref. No. 114101
	olive for pipe ø 10mm Qty 1 pcs		
	Part No.	101286	Ref. No. —
	olive ID ø 6mm Qty 1 pcs		
	Part No.	101300	Ref. No. —
	union nut thread M16x1.5 tube ø 10mm		
	Part No.	101450	Ref. No. —
	olive for pipe ø 8mm L 12.7mm Qty 1 pcs ED ø 10mm		
	Part No.	101451	Ref. No. —
	union nut thread M16x1.5 tube ø 8mm		
	Part No.	110078	Ref. No. —
	knob without symbol ø 70mm shaft ø 6x4.6mm shaft flat universal		
	Part No.	112206	Ref. No. —
	knob dial plate silver gas tap PEL21/22/23 t.max.°C ED ø 63mm ID ø 45.5mm		



Part No.	101672	Ref. No.	150128
description	gas tap PEL type 21S gas inlet pipe flange ø21mm bypass nozzle ø 0.85mm gas outlet M17x1 (tube ø 10/8.5mm) thermocouple connection M8x1 pilot connection M10x1 shaft ø 6x4.6mm shaft L 30/23mm shaft flat upper		
For models:	EGH210, EGH410, EGH413, EGH417, EGH610, EGH613, EGH617		
spare parts for	101672		
	Part No.	100527	Ref. No. —
	bypass nozzle type PEL20/21 bore ø 0.85mm thread M5x0.5		
	Part No.	100908	Ref. No. —
	union screw thread M10x1 for pipe ø 4mm Qty 1 pcs		

spare parts for		101672	
	Part No.	101060	Ref. No. 407088
	magnet unit standard L 39mm D1 ø 15.4mm D2 ø 11mm suitable for PEL20-21/JUNKERS/EGA		
	Part No.	101230	Ref. No. —
	thermocouple nut T1: M8x1 T2: M18x1 aluminium		
	Part No.	101246	Ref. No. —
	olive for pipe ø 4mm Qty 1 pcs		

accessories for		101672	
	Part No.	100909	Ref. No. —
	union screw thread M10x1 for pipe ø 6mm Qty 1 pcs		
	Part No.	100943	Ref. No. —
	union nut thread M17x1 tube ø 10mm		
	Part No.	101278	Ref. No. 114101
	olive for pipe ø 10mm Qty 1 pcs		
	Part No.	101286	Ref. No. —
	olive ID ø 6mm Qty 1 pcs		
	Part No.	110078	Ref. No. —
	knob without symbol ø 70mm shaft ø 6x4.6mm shaft flat universal		
	Part No.	112206	Ref. No. —
	knob dial plate silver gas tap PEL21/22/23 t.max.°C ED ø 63mm ID ø 45.5mm		

23S/V series



Part No.	101630	Ref. No.	177208
description	gas tap PEL type 23S/V gas inlet 1/2" IT bypass nozzle ø 0.35mm gas outlet 1/2" MT (tube ø 14mm) thermocouple connection M10x1 pilot connection M10x1 shaft ø 10mm shaft L 25mm shaft flat		
For models:	LGP400, LGS060, NGP400, NGP600, NGP900, NGS040, NGS060, NGS080, NGS100, NGS150		
spare parts for	101630		
	Part No.	100455	Ref. No. —
	bypass nozzle type PEL23/24 bore ø 0.35mm thread M8x0.5		
	Part No.	101059	Ref. No. —
	magnet unit T1: M10x1 T2: M22x1 L 46mm ø 18mm suitable for PEL23S M10x1		
	Part No.	102767	Ref. No. —
	gas tap front part shaft ø 10mm shaft L 26.5mm shaft flat suitable for PEL23S		
accessories for	101630		
	Part No.	100908	Ref. No. —
	union screw thread M10x1 for pipe ø 4mm Qty 1 pcs		

Table continues overleaf













accessories for		101630		
	Part No.	100909	Ref. No.	—
	union screw thread M10x1 for pipe ø 6mm Qty 1 pcs			
	Part No.	100945	Ref. No.	—
	roll pin ø 3.2mm L 10mm			
	Part No.	101218	Ref. No.	—
	shaft extension JUNKERS			
	Part No.	101219	Ref. No.	752972000
	shaft extension L 25mm JUNKERS			
	Part No.	101246	Ref. No.	—
	olive for pipe ø 4mm Qty 1 pcs			
	Part No.	101286	Ref. No.	—
	olive ID ø 6mm Qty 1 pcs			
	Part No.	110064	Ref. No.	—
	knob			
	Part No.	110066	Ref. No.	133364
	knob screw			
	Part No.	550396	Ref. No.	—
	shaft extension L 25mm JUNKERS			

alternatives to EGA

GPEL21 series

with nozzle outlet

				
1				
Part No.	101734	Ref. No.	151003	
description	gas tap			



				
1				
Part No.	101737 ¹	Ref. No.	151003 406928	
description	gas tap alternatives to EGA type GPEL21D gas inlet M15x1 (tube ø 10mm) external nozzle ø fixed 4.2mm internal nozzle ø 2.05mm bypass nozzle ø 0.35mm mixing pipe connection M17x1 thermocouple connection M8x1 pilot connection M10x1 shaft ø 6x4.6mm shaft L 31/23mm shaft flat left			
For models:	NGH410, NGH413, NGH415, NGH417, NGH610, NGH613, NGH615, NGH617			
spare parts for	101737			
	Part No.	100397	Ref. No.	152636
	internal nozzle bore ø 2.05mm suitable for EGA26400/26440			
	Part No.	100408	Ref. No.	—
	bypass nozzle type PEL20/21 bore ø 0.35mm thread M5x0.5			
	Part No.	101060	Ref. No.	407088
	magnet unit standard L 39mm D1 ø 15.4mm D2 ø 11mm suitable for PEL20-21/JUNKERS/EGA			
	Part No.	101230	Ref. No.	—
	thermocouple nut T1: M8x1 T2: M18x1 aluminium			
	Part No.	101802	Ref. No.	—
	gas tap front part shaft ø 6x4.6mm shaft L 30/23mm shaft flat right/ left suitable for PEL21			
accessories for	101737			
	Part No.	100942	Ref. No.	—
	union nut thread M15x1 for pipe ø 10mm			
	Part No.	100943	Ref. No.	—
	union nut thread M17x1 tube ø 10mm			
	Part No.	101278	Ref. No.	114101
	olive for pipe ø 10mm Qty 1 pcs			
	Part No.	101394	Ref. No.	—
	nut thread M17x1 H 3mm WS 19 brass Qty 1 pcs			

¹external nozzle cannot be replaced



			
1			
Part No.	101653 ¹	Ref. No.	150001
description	gas tap alternatives to EGA type GPEL21D with nozzle outlet (with internal nozzle) gas inlet M15x1 (tube ø 10mm) external nozzle ø fixed 4.2mm internal nozzle ø 1.4mm bypass nozzle ø 0.85mm mixing pipe connection M17x1 thermocouple connection M8x1 pilot connection M10x1 shaft ø 6x4.6mm shaft L 31/23mm shaft flat left		
spare parts for	101653		
	Part No.	100395	Ref. No. 152634
	internal nozzle bore ø 1.4mm suitable for EGA26400/26440		
	Part No.	100527	Ref. No. —
	bypass nozzle type PEL20/21 bore ø 0.85mm thread M5x0.5		
	Part No.	100908	Ref. No. —
	union screw thread M10x1 for pipe ø 4mm Qty 1 pcs		
	Part No.	101060	Ref. No. 407088
	magnet unit standard L 39mm D1 ø 15.4mm D2 ø 11mm suitable for PEL20-21/JUNKERS/EGA		
	Part No.	101230	Ref. No. —
	thermocouple nut T1: M8x1 T2: M18x1 aluminium		
	Part No.	101246	Ref. No. —
	olive for pipe ø 4mm Qty 1 pcs		
	Part No.	101802	Ref. No. —
	gas tap front part shaft ø 6x4.6mm shaft L 30/23mm shaft flat right/left suitable for PEL21		
accessories for	101653		
	Part No.	100909	Ref. No. —
	union screw thread M10x1 for pipe ø 6mm Qty 1 pcs		
	Part No.	100926	Ref. No. —
	centring piece thread M17x1		
	Part No.	100942	Ref. No. —
	union nut thread M15x1 for pipe ø 10mm		
	Part No.	101278	Ref. No. 114101
	olive for pipe ø 10mm Qty 1 pcs		
	Part No.	101286	Ref. No. —
	olive ID ø 6mm Qty 1 pcs		
	Part No.	110078	Ref. No. —
	knob without symbol ø 70mm shaft ø 6x4.6mm shaft flat universal		
	Part No.	112206	Ref. No. —
	knob dial plate silver gas tap PEL21/22/23 t.max.°C ED ø 63mm ID ø 45.5mm		

¹external nozzle cannot be replaced







			
1			
Part No.	101736 ¹	Ref. No.	151002 406929
description	gas tap alternatives to EGA type GPEL21D with nozzle outlet (with internal nozzle) gas inlet M15x1 (tube ø 10mm) external nozzle ø fixed 4.2mm internal nozzle ø 1.8mm bypass nozzle ø 0.35mm mixing pipe connection M17x1 thermocouple connection M8x1 pilot connection M10x1 shaft ø 6x4.6mm shaft L 31/23mm shaft flat left		
For models:	NGH210, NGH410, NGH413, NGH415, NGH417, NGH610, NGH613, NGH615, NGH617, NGH730, NGH733, NGH737		
spare parts for	101736		
	Part No.	100396	Ref. No. 152635
	internal nozzle bore ø 1.8mm suitable for EGA26400/26440		
	Part No.	100408	Ref. No. —
	bypass nozzle type PEL20/21 bore ø 0.35mm thread M5x0.5		
	Part No.	101060	Ref. No. 407088
	magnet unit standard L 39mm D1 ø 15.4mm D2 ø 11mm suitable for PEL20-21/JUNKERS/EGA		
	Part No.	101230	Ref. No. —
	thermocouple nut T1: M8x1 T2: M18x1 aluminium		
	Part No.	101802	Ref. No. —
	gas tap front part shaft ø 6x4.6mm shaft L 30/23mm shaft flat right/left suitable for PEL21		
accessories for	101736		
	Part No.	100942	Ref. No. —
	union nut thread M15x1 for pipe ø 10mm		
	Part No.	100943	Ref. No. —
	union nut thread M17x1 tube ø 10mm		
	Part No.	101278	Ref. No. 114101
	olive for pipe ø 10mm Qty 1 pcs		
	Part No.	101394	Ref. No. —
	nut thread M17x1 H 3mm WS 19 brass Qty 1 pcs		

¹external nozzle cannot be replaced

















			
1			
Part No.	101654 ¹	Ref. No.	150002
description	gas tap alternatives to EGA type GPEL21D with nozzle outlet (with internal nozzle) gas inlet M15x1 (tube ø 10mm) external nozzle ø fixed 4.2mm internal nozzle ø 1.8mm bypass nozzle ø 1.1mm mixing pipe connection M17x1 thermocouple connection M8x1 pilot connection M10x1 shaft ø 6x4.6mm shaft L 31/23mm shaft flat left		
spare parts for	101654		
	Part No.	100396	Ref. No. 152635
	internal nozzle bore ø 1.8mm suitable for EGA26400/26440		
	Part No.	100530	Ref. No. —
	bypass nozzle type PEL20/21 bore ø 1.1mm thread M5x0.5		
	Part No.	100908	Ref. No. —
	union screw thread M10x1 for pipe ø 4mm Qty 1 pcs		
	Part No.	101060	Ref. No. 407088
	magnet unit standard L 39mm D1 ø 15.4mm D2 ø 11mm suitable for PEL20-21/JUNKERS/EGA		
	Part No.	101230	Ref. No. —
	thermocouple nut T1: M8x1 T2: M18x1 aluminium		
	Part No.	101246	Ref. No. —
	olive for pipe ø 4mm Qty 1 pcs		
	Part No.	101802	Ref. No. —
	gas tap front part shaft ø 6x4.6mm shaft L 30/23mm shaft flat right/ left suitable for PEL21		
accessories for	101654		
	Part No.	100909	Ref. No. —
	union screw thread M10x1 for pipe ø 6mm Qty 1 pcs		
	Part No.	100926	Ref. No. —
	centring piece thread M17x1		
	Part No.	100942	Ref. No. —
	union nut thread M15x1 for pipe ø 10mm		
	Part No.	101278	Ref. No. 114101
	olive for pipe ø 10mm Qty 1 pcs		
	Part No.	101286	Ref. No. —
	olive ID ø 6mm Qty 1 pcs		
	Part No.	110078	Ref. No. —
	knob without symbol ø 70mm shaft ø 6x4.6mm shaft flat universal		
	Part No.	112206	Ref. No. —
	knob dial plate silver gas tap PEL21/22/23 t.max.°C ED ø 63mm ID ø 45.5mm		





¹external nozzle cannot be replaced

			
1			
Part No.	101655 ¹	Ref. No.	150003
description	gas tap alternatives to EGA type GPEL21D with nozzle outlet (with internal nozzle) gas inlet M15x1 (tube ø 10mm) external nozzle ø fixed 4.2mm internal nozzle ø 2.05mm bypass nozzle ø 1.25mm mixing pipe connection M17x1 thermocouple connection M8x1 pilot connection M10x1 shaft ø 6x4.6mm shaft L 31/23mm shaft flat left		
spare parts for	101655		
	Part No.	100394	Ref. No. —
	bypass nozzle type PEL20/21 bore ø 1.25mm thread M5x0.5		
	Part No.	100397	Ref. No. 152636
	internal nozzle bore ø 2.05mm suitable for EGA26400/26440		
	Part No.	100908	Ref. No. —
	union screw thread M10x1 for pipe ø 4mm Qty 1 pcs		
	Part No.	101060	Ref. No. 407088
	magnet unit standard L 39mm D1 ø 15.4mm D2 ø 11mm suitable for PEL20-21/JUNKERS/EGA		
	Part No.	101230	Ref. No. —
	thermocouple nut T1: M8x1 T2: M18x1 aluminium		
	Part No.	101246	Ref. No. —
	olive for pipe ø 4mm Qty 1 pcs		
	Part No.	101802	Ref. No. —
	gas tap front part shaft ø 6x4.6mm shaft L 30/23mm shaft flat right/ left suitable for PEL21		
accessories for	101655		
	Part No.	100909	Ref. No. —
	union screw thread M10x1 for pipe ø 6mm Qty 1 pcs		
	Part No.	100926	Ref. No. —
	centring piece thread M17x1		
	Part No.	100942	Ref. No. —
	union nut thread M15x1 for pipe ø 10mm		
	Part No.	101278	Ref. No. 114101
	olive for pipe ø 10mm Qty 1 pcs		
	Part No.	101286	Ref. No. —
	olive ID ø 6mm Qty 1 pcs		
	Part No.	110078	Ref. No. —
	knob without symbol ø 70mm shaft ø 6x4.6mm shaft flat universal		
	Part No.	112206	Ref. No. —
	knob dial plate silver gas tap PEL21/22/23 t.max.°C ED ø 63mm ID ø 45.5mm		

¹external nozzle cannot be replaced



			
1			
Part No.	101633	Ref. No.	170882 406938 406949
description	gas tap alternatives to EGA type GPEL21D with nozzle outlet (with nozzle) gas inlet M15x1 (tube ø 10mm) external nozzle ø 1.4mm internal nozzle ø 0.8mm bypass nozzle ø 0.35mm mixing pipe connection M17x1 thermocouple connection M8x1 pilot connection M10x1 shaft ø 6x4.6mm shaft L 31/23mm shaft flat left		
For models:	NGH200, NGH202, NGH400, NGH403, NGH405, NGH407, NGH600, NGH603, NGH605, NGH607		
spare parts for	101633		
	Part No.	100307	Ref. No. —
	gas injector thread M12x1 WS 14 bore ø 1.40mm		
	Part No.	100311	Ref. No. 406938
	internal nozzle bore ø 0.80mm suitable for EGA26400/26440		
	Part No.	100408	Ref. No. —
	bypass nozzle type PEL20/21 bore ø 0.35mm thread M5x0.5		
	Part No.	100927	Ref. No. —
	torsion spring L 2.8-8.0mm for internal nozzle ø 3mm bore ømm		
	Part No.	101060	Ref. No. 407088
	magnet unit standard L 39mm D1 ø 15.4mm D2 ø 11mm suitable for PEL20-21/JUNKERS/EGA		
	Part No.	101230	Ref. No. —
	thermocouple nut T1: M8x1 T2: M18x1 aluminium		
	Part No.	101526	Ref. No. —
	O-ring Viton thickness 1.78mm ID ø 4.48mm Qty 1 pcs		
	Part No.	101593	Ref. No. —
	adjusting screw for internal nozzle thread M8x0.75		
	Part No.	101802	Ref. No. —
	gas tap front part shaft ø 6x4.6mm shaft L 30/23mm shaft flat right/left suitable for PEL21		
accessories for	101633		
	Part No.	100908	Ref. No. —
	union screw thread M10x1 for pipe ø 4mm Qty 1 pcs		
	Part No.	100909	Ref. No. —
	union screw thread M10x1 for pipe ø 6mm Qty 1 pcs		
	Part No.	100926	Ref. No. —
	centring piece thread M17x1		
	Part No.	100942	Ref. No. —
	union nut thread M15x1 for pipe ø 10mm		
	Part No.	101246	Ref. No. —
	olive for pipe ø 4mm Qty 1 pcs		







accessories for	101633		
	Part No.	101278	Ref. No. 114101
	olive for pipe ø 10mm Qty 1 pcs		
	Part No.	101286	Ref. No. —
	olive ID ø 6mm Qty 1 pcs		
	Part No.	110078	Ref. No. —
	knob without symbol ø 70mm shaft ø 6x4.6mm shaft flat universal		
	Part No.	112206	Ref. No. —
	knob dial plate silver gas tap PEL21/22/23 t.max.°C ED ø 63mm ID ø 45.5mm		

			
1			
Part No.	101634	Ref. No.	170883 406929 406948
description	gas tap alternatives to EGA type GPEL21D with nozzle outlet (with nozzle) gas inlet M15x1 (tube ø 10mm) external nozzle ø 1.85mm internal nozzle ø 1.05mm bypass nozzle ø 0.5mm mixing pipe connection M17x1 thermocouple connection M8x1 pilot connection M10x1 shaft ø 6x4.6mm shaft L 31/23mm shaft flat left		
For models:	NGH200, NGH202, NGH400, NGH403, NGH405, NGH407, NGH600, NGH603, NGH605, NGH607, NGH720, NGH723, NGH725, NGH727		
spare parts for	101634		
	Part No.	100302	Ref. No. —
	gas injector thread M12x1 WS 14 bore ø 1.85mm		
	Part No.	100312	Ref. No. —
	internal nozzle bore ø 1.05mm suitable for EGA26400/26440		
	Part No.	100526	Ref. No. —
	bypass nozzle type PEL20/21 bore ø 0.5mm thread M5x0.5		
	Part No.	100927	Ref. No. —
	torsion spring L 2.8-8.0mm for internal nozzle ø 3mm bore ømm		
	Part No.	101060	Ref. No. 407088
	magnet unit standard L 39mm D1 ø 15.4mm D2 ø 11mm suitable for PEL20-21/JUNKERS/EGA		
	Part No.	101230	Ref. No. —
	thermocouple nut T1: M8x1 T2: M18x1 aluminium		
	Part No.	101526	Ref. No. —
	O-ring Viton thickness 1.78mm ID ø 4.48mm Qty 1 pcs		
	Part No.	101593	Ref. No. —
	adjusting screw for internal nozzle thread M8x0.75		
	Part No.	101802	Ref. No. —
	gas tap front part shaft ø 6x4.6mm shaft L 30/23mm shaft flat right/left suitable for PEL21		
accessories for	101634		
	Part No.	100908	Ref. No. —
	union screw thread M10x1 for pipe ø 4mm Qty 1 pcs		



Table continues overleaf





accessories for		101634		
Part No.		100909	Ref. No.	—
	union screw	thread M10x1 for pipe ø 6mm	Qty 1 pcs	
	centring piece	thread M17x1		
	union nut	thread M15x1 for pipe ø 10mm		
	olive	for pipe ø 4mm	Qty 1 pcs	
	olive	for pipe ø 10mm	Qty 1 pcs	114101
	olive	ID ø 6mm	Qty 1 pcs	
	knob	without symbol ø 70mm shaft ø 6x4.6mm shaft flat universal		
	knob dial plate	silver gas tap PEL21/22/23 t.max.°C ED ø 63mm ID ø 45.5mm		

				
1				
Part No.	101735 ¹	Ref. No.	151001 406930	
description	gas tap alternatives to EGA type GPEL21D with nozzle outlet (with nozzle) gas inlet M15x1 (tube ø 10mm) external nozzle ø fixed 4.2mm internal nozzle ø 1.4mm bypass nozzle ø 0.35mm mixing pipe connection M17x1 thermocouple connection M8x1 pilot connection M10x1 shaft ø 6x4.6mm shaft L 31/23mm shaft flat left			
spare parts for	101735			
	Part No.	100395	Ref. No.	152634
	internal nozzle	bore ø 1.4mm suitable for EGA26400/26440		
	Part No.	100408	Ref. No.	—
	bypass nozzle	type PEL20/21 bore ø 0.35mm thread M5x0.5		
	Part No.	101060	Ref. No.	407088
	magnet unit	standard L 39mm D1 ø 15.4mm D2 ø 11mm suitable for PEL20-21/JUNKERS/EGA		
	Part No.	101230	Ref. No.	—
	thermocouple nut	T1: M8x1 T2: M18x1 aluminium		
	Part No.	101802	Ref. No.	—
	gas tap front part	shaft ø 6x4.6mm shaft L 30/23mm shaft flat right/left suitable for PEL21		
accessories for	101735			
	Part No.	100942	Ref. No.	—
	union nut	thread M15x1 for pipe ø 10mm		



¹external nozzle cannot be replaced

accessories for		101735		
Part No.		100943	Ref. No.	—
	union nut	thread M17x1 tube ø 10mm		
	olive	for pipe ø 10mm	Qty 1 pcs	114101
	nut	thread M17x1 H 3mm WS 19 brass	Qty 1 pcs	

with pipe outlet				
				
1				
Part No.	101646 ¹	Ref. No.	170737 406937	
description	gas tap alternatives to EGA type GPEL20RD with pipe outlet with throttle screw gas inlet M15x1 (tube ø 10mm) bypass nozzle ø 0.35mm gas outlet M17x1 (tube ø 10mm) thermocouple connection M8x1 pilot connection M10x1 shaft ø 6x4.6mm shaft L 31/23mm shaft flat upper			
spare parts for	101646			
	Part No.	100408	Ref. No.	—
	bypass nozzle	type PEL20/21 bore ø 0.35mm thread M5x0.5		
	Part No.	101060	Ref. No.	407088
	magnet unit	standard L 39mm D1 ø 15.4mm D2 ø 11mm suitable for PEL20-21/JUNKERS/EGA		
	Part No.	101230	Ref. No.	—
	thermocouple nut	T1: M8x1 T2: M18x1 aluminium		
	Part No.	101526	Ref. No.	—
	O-ring	Viton thickness 1.78mm ID ø 4.48mm	Qty 1 pcs	
	Part No.	101552	Ref. No.	—
	throttle screw	thread M8x0.75		
accessories for	101646			
	Part No.	100908	Ref. No.	—
	union screw	thread M10x1 for pipe ø 4mm	Qty 1 pcs	
	Part No.	100909	Ref. No.	—
	union screw	thread M10x1 for pipe ø 6mm	Qty 1 pcs	
	Part No.	100926	Ref. No.	—
	centring piece	thread M17x1		
	Part No.	100942	Ref. No.	—
	union nut	thread M15x1 for pipe ø 10mm		
	Part No.	101246	Ref. No.	—
	olive	for pipe ø 4mm	Qty 1 pcs	
	Part No.	101278	Ref. No.	114101
	olive	for pipe ø 10mm	Qty 1 pcs	

¹with reducer for main gas line
Table continues overleaf















accessories for	101646		
	Part No.	101286	Ref. No. —
	olive ID ø 6mm Qty 1 pcs		
	Part No.	110078	Ref. No. —
	knob without symbol ø 70mm shaft ø 6x4.6mm shaft flat universal		
	Part No.	112206	Ref. No. —
	knob dial plate silver gas tap PEL21/22/23 t.max.°C ED ø 63mm ID ø 45.5mm		



Part No.	101658	Ref. No.	150003
description	gas tap alternatives to EGA type GPEL21 with pipe outlet gas inlet M15x1 (tube ø 10mm) bypass nozzle ø 0.6mm gas outlet M17x1 (tube ø 10mm) thermocouple connection M8x1 pilot connection M10x1 shaft ø 6x4.6mm shaft L 31/23mm shaft flat upper		
spare parts for	101658		
	Part No.	100551	Ref. No. —
	bypass nozzle type PEL20/21 bore ø 0.6mm thread M5x0.5		
	Part No.	100908	Ref. No. —
	union screw thread M10x1 for pipe ø 4mm Qty 1 pcs		
	Part No.	101060	Ref. No. 407088
	magnet unit standard L 39mm D1 ø 15.4mm D2 ø 11mm suitable for PEL20-21/JUNKERS/EGA		
	Part No.	101230	Ref. No. —
	thermocouple nut T1: M8x1 T2: M18x1 aluminium		
	Part No.	101246	Ref. No. —
	olive for pipe ø 4mm Qty 1 pcs		
	Part No.	101803	Ref. No. —
	gas tap front part shaft ø 6x4.6mm shaft L 30/23mm shaft flat upper/lower suitable for PEL21		
accessories for	101658		
	Part No.	100909	Ref. No. —
	union screw thread M10x1 for pipe ø 6mm Qty 1 pcs		
	Part No.	100942	Ref. No. —
	union nut thread M15x1 for pipe ø 10mm		
	Part No.	100943	Ref. No. —
	union nut thread M17x1 tube ø 10mm		
	Part No.	101278	Ref. No. 114101
	olive for pipe ø 10mm Qty 1 pcs		
	Part No.	101286	Ref. No. —
	olive ID ø 6mm Qty 1 pcs		
	Part No.	110078	Ref. No. —
	knob without symbol ø 70mm shaft ø 6x4.6mm shaft flat universal		

accessories for	101658		
	Part No.	112206	Ref. No. —
	knob dial plate silver gas tap PEL21/22/23 t.max.°C ED ø 63mm ID ø 45.5mm		















Part No.	101650	Ref. No.	150117
description	gas tap alternatives to EGA type GPEL21R with pipe outlet gas inlet M15x1 (tube ø 10mm) bypass nozzle ø 0.35mm gas outlet M17x1 (tube ø 10mm) thermocouple connection M8x1 pilot connection M10x1 shaft ø 6x4.6mm shaft L 31/23mm shaft flat left		
For models:	PGH418, PGH618		
spare parts for	101650		
	Part No.	100408	Ref. No. —
	bypass nozzle type PEL20/21 bore ø 0.35mm thread M5x0.5		
	Part No.	100908	Ref. No. —
	union screw thread M10x1 for pipe ø 4mm Qty 1 pcs		
	Part No.	101060	Ref. No. 407088
	magnet unit standard L 39mm D1 ø 15.4mm D2 ø 11mm suitable for PEL20-21/JUNKERS/EGA		
	Part No.	101230	Ref. No. —
	thermocouple nut T1: M8x1 T2: M18x1 aluminium		
	Part No.	101246	Ref. No. —
	olive for pipe ø 4mm Qty 1 pcs		
	Part No.	101802	Ref. No. —
	gas tap front part shaft ø 6x4.6mm shaft L 30/23mm shaft flat right/left suitable for PEL21		
accessories for	101650		
	Part No.	100942	Ref. No. —
	union nut thread M15x1 for pipe ø 10mm		
	Part No.	100943	Ref. No. —
	union nut thread M17x1 tube ø 10mm		
	Part No.	101278	Ref. No. 114101
	olive for pipe ø 10mm Qty 1 pcs		
	Part No.	101286	Ref. No. —
	olive ID ø 6mm Qty 1 pcs		
	Part No.	110078	Ref. No. —
	knob without symbol ø 70mm shaft ø 6x4.6mm shaft flat universal		
	Part No.	112206	Ref. No. —
	knob dial plate silver gas tap PEL21/22/23 t.max.°C ED ø 63mm ID ø 45.5mm		



1

Part No.	101651	Ref. No.	150118
description	gas tap alternatives to EGA type GPEL21R with pipe outlet gas inlet M15x1 (tube ø 10mm) bypass nozzle ø 1.1mm gas outlet M17x1 (tube ø 10mm) thermocouple connection M8x1 pilot connection M10x1 shaft ø 6x4.6mm shaft L 31/23mm shaft flat left		
For models:	PGH218, PGH418, PGH618		
spare parts for	101651		
	Part No.	100530	Ref. No. —
	bypass nozzle type PEL20/21 bore ø 1.1mm thread M5x0.5		
	Part No.	100908	Ref. No. —
	union screw thread M10x1 for pipe ø 4mm Qty 1 pcs		
	Part No.	101060	Ref. No. 407088
	magnet unit standard L 39mm D1 ø 15.4mm D2 ø 11mm suitable for PEL20-21/JUNKERS/EGA		
	Part No.	101230	Ref. No. —
	thermocouple nut T1: M8x1 T2: M18x1 aluminium		
	Part No.	101246	Ref. No. —
	olive for pipe ø 4mm Qty 1 pcs		
	Part No.	101802	Ref. No. —
	gas tap front part shaft ø 6x4.6mm shaft L 30/23mm shaft flat right/ left suitable for PEL21		
accessories for	101651		
	Part No.	100909	Ref. No. —
	union screw thread M10x1 for pipe ø 6mm Qty 1 pcs		
	Part No.	100942	Ref. No. —
	union nut thread M15x1 for pipe ø 10mm		
	Part No.	100943	Ref. No. —
	union nut thread M17x1 tube ø 10mm		
	Part No.	101278	Ref. No. 114101
	olive for pipe ø 10mm Qty 1 pcs		
	Part No.	101286	Ref. No. —
	olive ID ø 6mm Qty 1 pcs		
	Part No.	110078	Ref. No. —
	knob without symbol ø 70mm shaft ø 6x4.6mm shaft flat universal		
	Part No.	112206	Ref. No. —
	knob dial plate silver gas tap PEL21/22/23 t.max.°C ED ø 63mm ID ø 45.5mm		

1

Part No.	101652	Ref. No.	150119
description	gas tap alternatives to EGA type GPEL21R with pipe outlet gas inlet M15x1 (tube ø 10mm) bypass nozzle ø 1.25mm gas outlet M17x1 (tube ø 10mm) thermocouple connection M8x1 pilot connection M10x1 shaft ø 6x4.6mm shaft L 31/23mm shaft flat left		
For models:	PGH418, PGH618		
spare parts for	101652		
	Part No.	100394	Ref. No. —
	bypass nozzle type PEL20/21 bore ø 1.25mm thread M5x0.5		
	Part No.	100908	Ref. No. —
	union screw thread M10x1 for pipe ø 4mm Qty 1 pcs		
	Part No.	101060	Ref. No. 407088
	magnet unit standard L 39mm D1 ø 15.4mm D2 ø 11mm suitable for PEL20-21/JUNKERS/EGA		
	Part No.	101230	Ref. No. —
	thermocouple nut T1: M8x1 T2: M18x1 aluminium		
	Part No.	101246	Ref. No. —
	olive for pipe ø 4mm Qty 1 pcs		
	Part No.	101802	Ref. No. —
	gas tap front part shaft ø 6x4.6mm shaft L 30/23mm shaft flat right/ left suitable for PEL21		
accessories for	101652		
	Part No.	100909	Ref. No. —
	union screw thread M10x1 for pipe ø 6mm Qty 1 pcs		
	Part No.	100942	Ref. No. —
	union nut thread M15x1 for pipe ø 10mm		
	Part No.	100943	Ref. No. —
	union nut thread M17x1 tube ø 10mm		
	Part No.	101278	Ref. No. 114101
	olive for pipe ø 10mm Qty 1 pcs		
	Part No.	101286	Ref. No. —
	olive ID ø 6mm Qty 1 pcs		
	Part No.	110078	Ref. No. —
	knob without symbol ø 70mm shaft ø 6x4.6mm shaft flat universal		
	Part No.	112206	Ref. No. —
	knob dial plate silver gas tap PEL21/22/23 t.max.°C ED ø 63mm ID ø 45.5mm		

















GPEL22 series

with nozzle outlet



1

Part No.	101656	Ref. No.	170725 170726 406964
description	gas tap alternatives to EGA type GPEL22D with nozzle outlet (with nozzle) gas inlet M18x1.5 (tube ø 12mm) external nozzle ø 4.4mm internal nozzle ø 2.5mm bypass nozzle ø 1.65mm mixing pipe connection M22x1 thermocouple connection M8x1 pilot connection M10x1 shaft ø 6x4.6mm shaft L 35/21mm shaft flat upper		
For models:	GHN201, GHN202, GHN401, GHN402, GHN601, GHN602, GHN801, GHN802, GHO101		
spare parts for	101656		
	Part No.	100329	Ref. No. —
	gas injector thread M15x1 bore ø 4.40mm WS 17		
	Part No.	100398	Ref. No. —
	internal nozzle bore ø 2.5mm type EGA/PEL22		
	Part No.	100413	Ref. No. —
	bypass nozzle type PEL22 bore ø 1.65mm thread M6x0.5		
	Part No.	100908	Ref. No. —
	union screw thread M10x1 for pipe ø 4mm Qty 1 pcs		
	Part No.	100927	Ref. No. —
	torsion spring L 2.8-8.0mm for internal nozzle ø 3mm bore ømm		
	Part No.	101058	Ref. No. —
	magnet unit L 39mm D1 ø 15.4mm D2 ø 13.5mm suitable for PEL22/ EGA24197 standard		
	Part No.	101230	Ref. No. —
	thermocouple nut T1: M8x1 T2: M18x1 aluminium		
	Part No.	101246	Ref. No. —
	olive for pipe ø 4mm Qty 1 pcs		
	Part No.	101460	Ref. No. —
	O-ring ø 12.37mm D1 ø 2.62mm suitable for PEL22		
	Part No.	101527	Ref. No. —
	O-ring Viton thickness 1.78mm ID ø 6.75mm Qty 1 pcs		
	Part No.	101594	Ref. No. —
	adjusting screw for internal nozzle thread M10x0.75		
accessories for	101656		
	Part No.	100909	Ref. No. —
	union screw thread M10x1 for pipe ø 6mm Qty 1 pcs		
	Part No.	100944	Ref. No. —
	union nut thread M18x1.5 for pipe ø 12mm		
	Part No.	101273	Ref. No. —
	olive for pipe ø 12mm L 9.5mm brass Qty 1 pcs suitable for universal		

accessories for	101656		
	Part No.	101286	Ref. No. —
	olive ID ø 6mm Qty 1 pcs		
	Part No.	110078	Ref. No. —
	knob without symbol ø 70mm shaft ø 6x4.6mm shaft flat universal		
	Part No.	112206	Ref. No. —
	knob dial plate silver gas tap PEL21/22/23 t.max.°C ED ø 63mm ID ø 45.5mm		













			
			1
Part No.	101622	Ref. No.	170725 170726
description	gas tap alternatives to EGA type PEL22S with nozzle outlet (without nozzle) gas inlet M18x1.5 (tube ø 12mm) external nozzle ømm internal nozzle ømm bypass nozzle ø 0.35mm mixing pipe connection M22x1 thermocouple connection M8x1 pilot connection M10x1 shaft ø 6x4.6mm shaft L 35/21mm shaft flat upper		
spare parts for	101622		
	Part No.	100259	Ref. No. —
	bypass nozzle type PEL22 bore ø 0.35mm thread M6x0.5		
	Part No.	100927	Ref. No. —
	torsion spring L 2.8-8.0mm for internal nozzle ø 3mm bore ømm		
	Part No.	101058	Ref. No. —
	magnet unit L 39mm D1 ø 15.4mm D2 ø 13.5mm suitable for PEL22/ EGA24197 standard		
	Part No.	101230	Ref. No. —
	thermocouple nut T1: M8x1 T2: M18x1 aluminium		
	Part No.	101460	Ref. No. —
	O-ring ø 12.37mm D1 ø 2.62mm suitable for PEL22		
	Part No.	101527	Ref. No. —
	O-ring Viton thickness 1.78mm ID ø 6.75mm Qty 1 pcs		
	Part No.	101594	Ref. No. —
	adjusting screw for internal nozzle thread M10x0.75		
	Part No.	101823	Ref. No. —
	gas tap front part shaft ø 6x4.6mm shaft L 35/21mm shaft flat upper/ lower suitable for PEL22		
accessories for	101622		
	Part No.	100908	Ref. No. —
	union screw thread M10x1 for pipe ø 4mm Qty 1 pcs		
	Part No.	100909	Ref. No. —
	union screw thread M10x1 for pipe ø 6mm Qty 1 pcs		
	Part No.	100944	Ref. No. —
	union nut thread M18x1.5 for pipe ø 12mm		

Table continues overleaf



accessories for		101622		
Part No.		101246	Ref. No.	—
	olive for pipe ø 4mm Qty 1 pcs			
	olive for pipe ø 12mm L 9.5mm brass Qty 1 pcs suitable for universal			
	olive ID ø 6mm Qty 1 pcs			
	knob without symbol ø 70mm shaft ø 6x4.6mm shaft flat universal			
	knob dial plate silver gas tap PEL21/22/23 t.max.°C ED ø 63mm ID ø 45.5mm			

accessories for		101657		
Part No.		100944	Ref. No.	—
	union nut thread M18x1.5 for pipe ø 12mm			
	olive for pipe ø 4mm Qty 1 pcs			
	olive for pipe ø 12mm L 9.5mm brass Qty 1 pcs suitable for universal			
	olive ID ø 6mm Qty 1 pcs			
	knob without symbol ø 70mm shaft ø 6x4.6mm shaft flat universal			
	knob dial plate silver gas tap PEL21/22/23 t.max.°C ED ø 63mm ID ø 45.5mm			

with pipe outlet



Part No.	101657	Ref. No.	170730	
description	gas tap alternatives to EGA type GPEL22RD with pipe outlet with throttle screw gas inlet M18x1.5 (tube ø 12mm) bypass nozzle ø 0.5mm gas outlet M18x1.5 (tube ø 12mm) thermocouple connection M8x1 pilot connection M10x1 shaft ø 6x4.6mm shaft L 35/21mm shaft flat upper			
For models:	GHN401, GHN601, GHN801, GPN402, GPP202, GWN101, GWN201, GWN202, NGH500, NGH503, NGH505, NGH720, NGH723, NGH725, NGH727, NGH730, NGH733, NGH737, PGH508			
spare parts for	101657			
	Part No.	100390	Ref. No.	—
	bypass nozzle type PEL22 bore ø 0.5mm thread M6x0.5			
	Part No.	101058	Ref. No.	—
	magnet unit L 39mm D1 ø 15.4mm D2 ø 13.5mm suitable for PEL22/EGA24197 standard			
	Part No.	101230	Ref. No.	—
	thermocouple nut T1: M8x1 T2: M18x1 aluminium			
	Part No.	101460	Ref. No.	—
	O-ring ø 12.37mm D1 ø 2.62mm suitable for PEL22			
	Part No.	101527	Ref. No.	—
	O-ring Viton thickness 1.78mm ID ø 6.75mm Qty 1 pcs			
	Part No.	101553	Ref. No.	—
	throttle screw thread M10x0.75			
accessories for	101657			
	Part No.	100908	Ref. No.	—
	union screw thread M10x1 for pipe ø 4mm Qty 1 pcs			
	Part No.	100909	Ref. No.	—
	union screw thread M10x1 for pipe ø 6mm Qty 1 pcs			

JUNKERS









Part No.	nla ¹	Ref. No.	177208	
description	gas tap JUNKERS type CH340 gas inlet 1/2" IT bypass nozzle ø 0.35mm gas outlet 1/2" ET thermocouple connection M10x1 pilot connection M10x1 shaft ø 10mm shaft L 20.7mm shaft flat			
spare parts for	101169			
	Part No.	101061	Ref. No.	407090
	magnet unit T1: M10x1 T2: M24x1 L 48mm ø 16mm suitable for JUNKERS CH330-340			
	Part No.	345200	Ref. No.	—
	microswitch with plunger			
accessories for	101169			
	Part No.	100945	Ref. No.	—
	roll pin ø 3.2mm L 10mm			
	Part No.	101218	Ref. No.	—
	shaft extension JUNKERS			
	Part No.	101219	Ref. No.	752972000
	shaft extension L 25mm JUNKERS			
	Part No.	101284	Ref. No.	114121
	olive for pipe ø 4mm Qty 1 pcs			
	Part No.	101285	Ref. No.	—
	union screw thread M8x1 for pipe ø 4mm Qty 1 pcs JUNKERS			
	Part No.	110064	Ref. No.	—
	knob			

¹no longer available
Table continues overleaf





accessories for	101169		
	Part No.	110066	Ref. No. 133364
	knob screw		
	Part No.	550396	Ref. No. —
	shaft extension L 25mm JUNKERS		

alternatives to JUNKERS

	1		
Part No.	101630	Ref. No.	177208
description	gas tap PEL type 23S/V gas inlet 1/2" IT bypass nozzle ø 0.35mm gas outlet 1/2" MT (tube ø 14mm) thermocouple connection M10x1 pilot connection M10x1 shaft ø 10mm shaft L 25mm shaft flat		
For models:	LGP400, LGS060, NGP400, NGP600, NGP900, NGS040, NGS060, NGS080, NGS100, NGS150		
spare parts for	101630		
	Part No.	100455	Ref. No. —
	bypass nozzle type PEL23/24 bore ø 0.35mm thread M8x0.5		
	Part No.	101059	Ref. No. —
	magnet unit T1: M10x1 T2: M22x1 L 46mm ø 18mm suitable for PEL23S M10x1		
	Part No.	102767	Ref. No. —
	gas tap front part shaft ø 10mm shaft L 26.5mm shaft flat suitable for PEL23S		
accessories for	101630		
	Part No.	100908	Ref. No. —
	union screw thread M10x1 for pipe ø 4mm Qty 1 pcs		
	Part No.	100909	Ref. No. —
	union screw thread M10x1 for pipe ø 6mm Qty 1 pcs		
	Part No.	100945	Ref. No. —
	roll pin ø 3.2mm L 10mm		
	Part No.	101218	Ref. No. —
	shaft extension JUNKERS		
	Part No.	101219	Ref. No. 752972000
	shaft extension L 25mm JUNKERS		
	Part No.	101246	Ref. No. —
	olive for pipe ø 4mm Qty 1 pcs		
	Part No.	101286	Ref. No. —
	olive ID ø 6mm Qty 1 pcs		
	Part No.	110064	Ref. No. —
	knob		
	Part No.	110066	Ref. No. 133364
	knob screw		

accessories for	101630		
	Part No.	550396	Ref. No. —
	shaft extension L 25mm JUNKERS		

STN3R











	1		
Part No.	106052	Ref. No.	150146
description	gas tap STN3R gas inlet M20x1.5 (tube ø 12mm) bypass nozzle ø 0mm gas outlet M20x1.5 (tube ø 12mm) thermocouple connection M8x1 shaft ø 6x4.6mm shaft L 39/18mm shaft flat upper suitable for KÜPPERSBUSCH		
For models:	EGS060, FGH500, FGH507, PGH508		
accessories for	106052		
	Part No.	101251	Ref. No. —
	union nut thread M20x1.5 for pipe ø 12mm		
	Part No.	101273	Ref. No. —
	olive for pipe ø 12mm L 9.5mm brass Qty 1 pcs suitable for universal		













	1		
Part No.	106053	Ref. No.	150143
description	gas tap STN3R gas inlet pipe flange ø23mm bypass nozzle ømm gas outlet M17x1 (tube ø 10mm) thermocouple connection M8x1 pilot connection M8x1 shaft ø 6x4.6mm shaft L 39/18mm shaft flat lower suitable for KÜPPERSBUSCH		
For models:	EGH210, EGH410, EGH413, EGH417, EGH610, EGH613, EGH617, FGH210, FGH410, FGH413, FGH415, FGH417, FGH610, FGH613, FGH615, FGH617, PGH218, PGH418, PGH618		



MADEC (MP)

with nozzle outlet

 <p>1</p>			
Part No.	101632	Ref. No.	170881 406979
description	gas tap MADEC type 170881 with nozzle outlet (with nozzle) gas inlet M12x1 (tube ø 8mm) external nozzle ø 2.2mm internal nozzle ø 1.4mm bypass nozzle ø 0.7mm mixing pipe connection M17x1 thermocouple connection M8x1 front fixing M12x1 shaft ø 6x4.6mm shaft L 37/17mm shaft flat lower		
For models:	LGH405, LGH407, LGH605, LGH607		
spare parts for	101632		
	Part No.	100293	Ref. No. —
	gas injector thread M12x1 WS 14 bore ø 2.20mm		
	Part No.	100423	Ref. No. —
	internal nozzle MADEC bore ø 1.4mm		
	Part No.	100427	Ref. No. —
	bypass nozzle MADEC bore ø 0.7mm thread M4.5x0.6		
	Part No.	101051	Ref. No. 160860
	magnet unit L 27mm D1 ø 12.5mm D2 ø 8.5mm suitable for JUNKERS/EGA/MADEC/SABAF standard		
accessories for	101632		
	Part No.	101277	Ref. No. —
	olive ID ø 8mm Qty 1 pcs		
	Part No.	101296	Ref. No. —
	union nut thread M12x1 for pipe ø 8mm		
	Part No.	101299	Ref. No. —
	nut thread M12x1		
	Part No.	101400	Ref. No. —
	air mixing tube thread M17x1 suitable for L350, L700		
	Part No.	110149	Ref. No. —
	knob gas tap without ignition flame t.max.°C temperature range°C ø 50mm shaft ø 6x4.6mm shaft flat right black		

 <p>1</p>			
Part No.	101631	Ref. No.	170880 406980
description	gas tap MADEC with nozzle outlet (with nozzle) gas inlet M12x1 (tube ø 8mm) external nozzle ø 2.2mm internal nozzle ø 1.2mm bypass nozzle ø 0.55mm mixing pipe connection M17x1 thermocouple connection M8x1 front fixing M12x1 shaft ø 6x4.6mm shaft L 37/17mm shaft flat lower		
For models:	LGH405, LGH407, LGH605, LGH607		
spare parts for	101631		
	Part No.	100293	Ref. No. —
	gas injector thread M12x1 WS 14 bore ø 2.20mm		
	Part No.	100422	Ref. No. —
	internal nozzle MADEC bore ø 1.2mm		
	Part No.	100426	Ref. No. —
	bypass nozzle MADEC bore ø 0.55mm thread M4.5x0.6		
	Part No.	101051	Ref. No. 160860
	magnet unit L 27mm D1 ø 12.5mm D2 ø 8.5mm suitable for JUNKERS/EGA/MADEC/SABAF standard		
	Part No.	101234	Ref. No. —
	union nut T1: M8x1 T2: M15		
accessories for	101631		
	Part No.	100943	Ref. No. —
	union nut thread M17x1 tube ø 10mm		
	Part No.	101277	Ref. No. —
	olive ID ø 8mm Qty 1 pcs		
	Part No.	101296	Ref. No. —
	union nut thread M12x1 for pipe ø 8mm		
	Part No.	101299	Ref. No. —
	nut thread M12x1		
	Part No.	101394	Ref. No. —
	nut thread M17x1 H 3mm WS 19 brass Qty 1 pcs		
	Part No.	101400	Ref. No. —
	air mixing tube thread M17x1 suitable for L350, L700		
	Part No.	110149	Ref. No. —
	knob gas tap without ignition flame t.max.°C temperature range°C ø 50mm shaft ø 6x4.6mm shaft flat right black		



EGA

26440 series

gas taps















1

Part No.	101733	Ref. No.	151002
description	gas tap EGA type 26440 series		



1

Part No.	101987	Ref. No.	170737
description	gas tap EGA type 26440 series		
For models:	LGB430, LGG420, NGB430, NGG420, NGW250, NGW450		
spare parts for	101987		
	Part No.	101060	Ref. No. 407088
	magnet unit standard L 39mm D1 ø 15.4mm D2 ø 11mm suitable for PEL20-21/JUNKERS/EGA		
	Part No.	101230	Ref. No. —
	thermocouple nut T1: M8x1 T2: M18x1 aluminium		
accessories for	101987		
	Part No.	100926	Ref. No. —
	centring piece thread M17x1		
	Part No.	100941	Ref. No. —
	union nut thread M15x1 for pipe ø 8mm		
	Part No.	100942	Ref. No. —
	union nut thread M15x1 for pipe ø 10mm		
	Part No.	100943	Ref. No. —
	union nut thread M17x1 tube ø 10mm		
	Part No.	101277	Ref. No. —
	olive ID ø 8mm Qty 1 pcs		
	Part No.	101278	Ref. No. 114101
	olive for pipe ø 10mm Qty 1 pcs		
	Part No.	101284	Ref. No. 114121
	olive for pipe ø 4mm Qty 1 pcs		
	Part No.	101285	Ref. No. —
	union screw thread M8x1 for pipe ø 4mm Qty 1 pcs JUNKERS		
	Part No.	101383	Ref. No. —
	reducer ø 10/8mm		
	Part No.	110078	Ref. No. —
	knob without symbol ø 70mm shaft ø 6x4.6mm shaft flat universal		

accessories for	101987		
	Part No.	112206	Ref. No. —
	knob dial plate silver gas tap PEL21/22/23 t.max.°C ED ø 63mm ID ø 45.5mm		



1



Part No.	104260	Ref. No.	151001
description	gas tap EGA type 26440 series		
For models:	NGH410, NGH413, NGH415, NGH417, NGH610, NGH613, NGH615, NGH617		
spare parts for	104260		
	Part No.	100346	Ref. No. 152681
	bypass nozzle EGA type 31248 series bore ø 0.85mm		
	Part No.	100395	Ref. No. 152634
	internal nozzle bore ø 1.4mm suitable for EGA26400/26440		
	Part No.	101060	Ref. No. 407088
	magnet unit standard L 39mm D1 ø 15.4mm D2 ø 11mm suitable for PEL20-21/JUNKERS/EGA		
	Part No.	101230	Ref. No. —
	thermocouple nut T1: M8x1 T2: M18x1 aluminium		
accessories for	104260		
	Part No.	100942	Ref. No. —
	union nut thread M15x1 for pipe ø 10mm		
	Part No.	101278	Ref. No. 114101
	olive for pipe ø 10mm Qty 1 pcs		
	Part No.	101284	Ref. No. 114121
	olive for pipe ø 4mm Qty 1 pcs		
	Part No.	101285	Ref. No. —
	union screw thread M8x1 for pipe ø 4mm Qty 1 pcs JUNKERS		
	Part No.	110078	Ref. No. —
	knob without symbol ø 70mm shaft ø 6x4.6mm shaft flat universal		
	Part No.	112206	Ref. No. —
	knob dial plate silver gas tap PEL21/22/23 t.max.°C ED ø 63mm ID ø 45.5mm		









gas thermostats

MERTIK



Part No.	101786	Ref. No.	152423
description	gas thermostat MERTIK t.max. 110°C 30-110°C gas inlet bottom 3/8" gas inlet lateral 3/8" gas outlet bottom 3/8" gas outlet lateral 3/8" thermocouple connection M10x1 capillary pipe 720mm probe ø 6mm probe L 80mm bain marie		
For models:	FGW250, PGW458		
spare parts for	101786		
	Part No.	106221	Ref. No. —
	magnet unit L 32mm D1 ø 19mm D2 ø 14mm suitable for MERTIK		
accessories for	101786		
	Part No.	100015	Ref. No. —
	ignition cable cable length 600mm connection ø2.4mm / ø2.4mm		
	Part No.	100018	Ref. No. —
	ignition cable cable length 600mm connection ø2.4mm / ø4mm permanent temperature 200°C		
	Part No.	100179	Ref. No. —
	ignition cable cable length 1200mm connection F2.8mm / ø2.4mm		
	Part No.	100193	Ref. No. —
	ignition cable cable length 1200mm connection ø2.4mm / ø4mm		
	Part No.	100197	Ref. No. —
	ignition cable cable length 600mm connection F2.8mm / ø2.4mm		
	Part No.	100904	Ref. No. 178462
	locking screw M10x1 for pipe ø 4mm Qty 1 pcs		
	Part No.	101273	Ref. No. —
	olive for pipe ø 12mm L 9.5mm brass Qty 1 pcs suitable for universal		
	Part No.	101276	Ref. No. —
	union screw thread 3/8" tube ø 12mm Qty 1 pcs		
	Part No.	102180	Ref. No. —
	ignition cable cable length 1200mm connection ø2.4mm / ø2.4mm		
	Part No.	106701	Ref. No. —
	knob adapter thickness 14mm ED ø 26mm shaft 8x6.5mm plastic		
	Part No.	106702	Ref. No. —
	plug thread 3/8" with O-ring L 12mm WS 8 brass suitable for MERTIK		
	Part No.	106719	Ref. No. —
	union screw for gas thermostat MERTIK M10x1 for thermocouple ET M22x1		
	Part No.	112387	Ref. No. —
	knob dial plate universal red		

accessories for	101786		
	Part No.	112388	Ref. No. —
	knob dial plate universal silver		
	Part No.	112598	Ref. No. —
	knob dial plate MERTIK gas regulator (piezoelectric igniter) silver		
	Part No.	112599	Ref. No. —
	knob dial plate MERTIK gas regulator (piezoelectric igniter) red		
	Part No.	112601	Ref. No. —
	knob dial plate silver gas thermostat MERTIK 1-8 t.max.°C ED ø 59mm ID ø 45.5mm		
	Part No.	112602	Ref. No. —
	knob dial plate red gas thermostat MERTIK 1-8 t.max.°C ED ø 59mm ID ø 45.5mm		
	Part No.	112949	Ref. No. —
	knob MERTIK gas regulator ø 62mm shaft flat upper black special fixing shaft 8x6.5		
	Part No.	112950	Ref. No. —
	knob MERTIK gas regulator ø 32mm black for piezoelectric igniter		





















Part No.	101746	Ref. No.	152421
description	gas thermostat MERTIK t.max. 195°C 100-195°C gas inlet bottom 3/8" gas inlet lateral 3/8" gas outlet bottom 3/8" gas outlet lateral 3/8" capillary pipe 720mm probe ø 6mm probe L 70mm gland nut 1/4" fryer		
For models:	PGF148, PGF228		
spare parts for	101746		
	Part No.	106221	Ref. No. —
	magnet unit L 32mm D1 ø 19mm D2 ø 14mm suitable for MERTIK		
accessories for	101746		
	Part No.	100015	Ref. No. —
	ignition cable cable length 600mm connection ø2.4mm / ø2.4mm		
	Part No.	100018	Ref. No. —
	ignition cable cable length 600mm connection ø2.4mm / ø4mm permanent temperature 200°C		
	Part No.	100179	Ref. No. —
	ignition cable cable length 1200mm connection F2.8mm / ø2.4mm		
	Part No.	100193	Ref. No. —
	ignition cable cable length 1200mm connection ø2.4mm / ø4mm		
	Part No.	100197	Ref. No. —
	ignition cable cable length 600mm connection F2.8mm / ø2.4mm		
	Part No.	100904	Ref. No. 178462
	locking screw M10x1 for pipe ø 4mm Qty 1 pcs		

Table continues overleaf

























accessories for		101746	
	Part No.	101273	Ref. No. —
olive for pipe ø 12mm L 9.5mm brass Qty 1 pcs suitable for universal			
	Part No.	101276	Ref. No. —
union screw thread 3/8" tube ø 12mm Qty 1 pcs			
	Part No.	102180	Ref. No. —
ignition cable cable length 1200mm connection ø2.4mm / ø2.4mm			
	Part No.	106701	Ref. No. —
knob adapter thickness 14mm ED ø 26mm shaft 8x6.5mm plastic			
	Part No.	106702	Ref. No. —
plug thread 3/8" with O-ring L 12mm WS 8 brass suitable for MERTIK			
	Part No.	106719	Ref. No. —
union screw for gas thermostat MERTIK M10x1 for thermocouple ET M22x1			
	Part No.	112387	Ref. No. —
knob dial plate universal red			
	Part No.	112388	Ref. No. —
knob dial plate universal silver			
	Part No.	112598	Ref. No. —
knob dial plate MERTIK gas regulator (piezoelectric igniter) silver			
	Part No.	112599	Ref. No. —
knob dial plate MERTIK gas regulator (piezoelectric igniter) red			
	Part No.	112601	Ref. No. —
knob dial plate silver gas thermostat MERTIK 1-8 t.max.°C ED ø 59mm ID ø 45.5mm			
	Part No.	112602	Ref. No. —
knob dial plate red gas thermostat MERTIK 1-8 t.max.°C ED ø 59mm ID ø 45.5mm			
	Part No.	112949	Ref. No. —
knob MERTIK gas regulator ø 62mm shaft flat upper black special fixing shaft 8x6.5			
	Part No.	112950	Ref. No. —
knob MERTIK gas regulator ø 32mm black for piezoelectric igniter			

			
Part No.	106222	Ref. No.	152429
description	gas thermostat MERTIK t.max. 195°C 100-195°C gas inlet bottom 3/8" gas inlet lateral 3/8" gas outlet bottom 3/8" gas outlet lateral 3/8" thermocouple connection M10x1 capillary pipe 720mm probe ø 6mm probe L 70mm gland nut 1/4"		
For models:	EGF124, EGF224		
spare parts for	106222		
	Part No.	106221	Ref. No. —
magnet unit L 32mm D1 ø 19mm D2 ø 14mm suitable for MERTIK			

accessories for		106222	
	Part No.	100015	Ref. No. —
ignition cable cable length 600mm connection ø2.4mm / ø2.4mm			
	Part No.	100018	Ref. No. —
ignition cable cable length 600mm connection ø2.4mm / ø4mm permanent temperature 200°C			
	Part No.	100179	Ref. No. —
ignition cable cable length 1200mm connection F2.8mm / ø2.4mm			
	Part No.	100193	Ref. No. —
ignition cable cable length 1200mm connection ø2.4mm / ø4mm			
	Part No.	100197	Ref. No. —
ignition cable cable length 600mm connection F2.8mm / ø2.4mm			
	Part No.	100904	Ref. No. 178462
locking screw M10x1 for pipe ø 4mm Qty 1 pcs			
	Part No.	101273	Ref. No. —
olive for pipe ø 12mm L 9.5mm brass Qty 1 pcs suitable for universal			
	Part No.	101276	Ref. No. —
union screw thread 3/8" tube ø 12mm Qty 1 pcs			
	Part No.	102180	Ref. No. —
ignition cable cable length 1200mm connection ø2.4mm / ø2.4mm			
	Part No.	106701	Ref. No. —
knob adapter thickness 14mm ED ø 26mm shaft 8x6.5mm plastic			
	Part No.	106702	Ref. No. —
plug thread 3/8" with O-ring L 12mm WS 8 brass suitable for MERTIK			
	Part No.	106719	Ref. No. —
union screw for gas thermostat MERTIK M10x1 for thermocouple ET M22x1			
	Part No.	112387	Ref. No. —
knob dial plate universal red			
	Part No.	112388	Ref. No. —
knob dial plate universal silver			
	Part No.	112598	Ref. No. —
knob dial plate MERTIK gas regulator (piezoelectric igniter) silver			
	Part No.	112599	Ref. No. —
knob dial plate MERTIK gas regulator (piezoelectric igniter) red			
	Part No.	112601	Ref. No. —
knob dial plate silver gas thermostat MERTIK 1-8 t.max.°C ED ø 59mm ID ø 45.5mm			
	Part No.	112602	Ref. No. —
knob dial plate red gas thermostat MERTIK 1-8 t.max.°C ED ø 59mm ID ø 45.5mm			
	Part No.	112949	Ref. No. —
knob MERTIK gas regulator ø 62mm shaft flat upper black special fixing shaft 8x6.5			
	Part No.	112950	Ref. No. —
knob MERTIK gas regulator ø 32mm black for piezoelectric igniter			



			
1			
Part No.	101745	Ref. No.	152430
description	gas thermostat MERTIK t.max. 340°C 100-340°C gas inlet bottom 3/8" gas inlet lateral 3/8" gas outlet bottom 3/8" gas outlet lateral 3/8" thermocouple connection M10x1 capillary pipe 720mm probe ø 4mm probe L 68mm griddle		
For models:	FGH417, FGH507, FGH617, PGB438		
spare parts for	101745		
	Part No.	106221	Ref. No. —
	magnet unit L 32mm D1 ø 19mm D2 ø 14mm suitable for MERTIK		
accessories for	101745		
	Part No.	100015	Ref. No. —
	ignition cable cable length 600mm connection ø2.4mm / ø2.4mm		
	Part No.	100018	Ref. No. —
	ignition cable cable length 600mm connection ø2.4mm / ø4mm permanent temperature 200°C		
	Part No.	100179	Ref. No. —
	ignition cable cable length 1200mm connection F2.8mm / ø2.4mm		
	Part No.	100193	Ref. No. —
	ignition cable cable length 1200mm connection ø2.4mm / ø4mm		
	Part No.	100197	Ref. No. —
	ignition cable cable length 600mm connection F2.8mm / ø2.4mm		
	Part No.	100904	Ref. No. 178462
	locking screw M10x1 for pipe ø 4mm Qty 1 pcs		
	Part No.	101273	Ref. No. —
	olive for pipe ø 12mm L 9.5mm brass Qty 1 pcs suitable for universal		
	Part No.	101276	Ref. No. —
	union screw thread 3/8" tube ø 12mm Qty 1 pcs		
	Part No.	102180	Ref. No. —
	ignition cable cable length 1200mm connection ø2.4mm / ø2.4mm		
	Part No.	106701	Ref. No. —
	knob adapter thickness 14mm ED ø 26mm shaft 8x6.5mm plastic		
	Part No.	106702	Ref. No. —
	plug thread 3/8" with O-ring L 12mm WS 8 brass suitable for MERTIK		
	Part No.	106719	Ref. No. —
	union screw for gas thermostat MERTIK M10x1 for thermocouple ET M22x1		
	Part No.	112387	Ref. No. —
	knob dial plate universal red		

accessories for	101745		
	Part No.	112388	Ref. No. —
	knob dial plate universal silver		
	Part No.	112598	Ref. No. —
	knob dial plate MERTIK gas regulator (piezoelectric igniter) silver		
	Part No.	112599	Ref. No. —
	knob dial plate MERTIK gas regulator (piezoelectric igniter) red		
	Part No.	112601	Ref. No. —
	knob dial plate silver gas thermostat MERTIK 1-8 t.max.°C ED ø 59mm ID ø 45.5mm		
	Part No.	112602	Ref. No. —
	knob dial plate red gas thermostat MERTIK 1-8 t.max.°C ED ø 59mm ID ø 45.5mm		
	Part No.	112949	Ref. No. —
	knob MERTIK gas regulator ø 62mm shaft flat upper black special fixing shaft 8x6.5		
	Part No.	112950	Ref. No. —
	knob MERTIK gas regulator ø 32mm black for piezoelectric igniter		























			
1			
Part No.	101744	Ref. No.	152453
description	gas thermostat MERTIK t.max. 340°C 100-340°C gas inlet bottom 3/8" gas inlet lateral 3/8" gas outlet bottom 3/8" gas outlet lateral 3/8" thermocouple connection M10x1 pilot connection M10x1 capillary pipe 730mm probe ø 4mm probe L 66mm cable length 1300mm with union screws and olives oven		
For models:	EGB230, EGB430, EGH417, EGH617, NGH417, NGH507, NGH617, NGH737, NPG600, NPG900		
spare parts for	101744		
	Part No.	106221	Ref. No. —
	magnet unit L 32mm D1 ø 19mm D2 ø 14mm suitable for MERTIK		
accessories for	101744		
	Part No.	100015	Ref. No. —
	ignition cable cable length 600mm connection ø2.4mm / ø2.4mm		
	Part No.	100018	Ref. No. —
	ignition cable cable length 600mm connection ø2.4mm / ø4mm permanent temperature 200°C		
	Part No.	100179	Ref. No. —
	ignition cable cable length 1200mm connection F2.8mm / ø2.4mm		
	Part No.	100193	Ref. No. —
	ignition cable cable length 1200mm connection ø2.4mm / ø4mm		
	Part No.	100197	Ref. No. —
	ignition cable cable length 600mm connection F2.8mm / ø2.4mm		

Table continues overleaf



accessories for		101744	
	Part No.	100904	Ref. No. 178462
	locking screw M10x1 for pipe ø 4mm Qty 1 pcs		
	Part No.	101273	Ref. No. —
	olive for pipe ø 12mm L 9.5mm brass Qty 1 pcs suitable for universal		
	Part No.	101276	Ref. No. —
	union screw thread 3/8" tube ø 12mm Qty 1 pcs		
	Part No.	102180	Ref. No. —
	ignition cable cable length 1200mm connection ø2.4mm / ø2.4mm		
	Part No.	106701	Ref. No. —
	knob adapter thickness 14mm ED ø 26mm shaft 8x6.5mm plastic		
	Part No.	106702	Ref. No. —
	plug thread 3/8" with O-ring L 12mm WS 8 brass suitable for MERTIK		
	Part No.	106719	Ref. No. —
	union screw for gas thermostat MERTIK M10x1 for thermocouple ET M22x1		
	Part No.	112387	Ref. No. —
	knob dial plate universal red		
	Part No.	112388	Ref. No. —
	knob dial plate universal silver		
	Part No.	112598	Ref. No. —
	knob dial plate MERTIK gas regulator (piezoelectric igniter) silver		
	Part No.	112599	Ref. No. —
	knob dial plate MERTIK gas regulator (piezoelectric igniter) red		
	Part No.	112601	Ref. No. —
	knob dial plate silver gas thermostat MERTIK 1-8 t.max.°C ED ø 59mm ID ø 45.5mm		
	Part No.	112602	Ref. No. —
	knob dial plate red gas thermostat MERTIK 1-8 t.max.°C ED ø 59mm ID ø 45.5mm		
	Part No.	112949	Ref. No. —
	knob MERTIK gas regulator ø 62mm shaft flat upper black special fixing shaft 8x6.5		
	Part No.	112950	Ref. No. —
	knob MERTIK gas regulator ø 32mm black for piezoelectric igniter		

PEL



24STS series



Part No.	106027	Ref. No.	540403
description	gas thermostat PEL type 24STS 100-300°C gas inlet M20x1.5 (tube ø 12/10mm) bypass nozzle ø 0mm gas outlet M20x1.5 (tube ø 12/10mm) thermocouple connection M9x1 pilot connection M10x1 capillary pipe 1200mm probe ø 6mm probe L 100mm shaft ø 10x8mm shaft L 27/17mm shaft flat upper t.max. 300°C		
spare parts for	106027		
	Part No.	100455	Ref. No. —
	bypass nozzle type PEL23/24 bore ø 0.35mm thread M8x0.5		
	Part No.	101058	Ref. No. —
	magnet unit L 39mm D1 ø 15.4mm D2 ø 13.5mm suitable for PEL22/EGA24197 standard		
accessories for	106027		
	Part No.	101235	Ref. No. —
	gas connection thread M20x1.5 tube ø 12/10mm for PEL gas taps horizontal		
	Part No.	101236	Ref. No. —
	gas connection thread M20x1.5 tube ø 12/10mm for PEL gas taps vertical		
	Part No.	101240	Ref. No. —
	gas connection thread M20x1.5 tube ø 12/10mm for PEL gas taps with gasket and screws horizontal		
	Part No.	101241	Ref. No. —
	gas connection thread M20x1.5 tube ø 12/10mm for PEL gas taps vertical		
	Part No.	101248	Ref. No. —
	olive for pipe ø 12mm Qty 1 pcs suitable for PEL		
	Part No.	101249	Ref. No. —
	olive for pipe ø 10mm Qty 1 pcs		
	Part No.	101250	Ref. No. —
	union nut thread M20x1.5 for pipe ø 10mm		
	Part No.	101251	Ref. No. —
	union nut thread M20x1.5 for pipe ø 12mm		
	Part No.	101356	Ref. No. —
	gas tap PEL type 21S gas inlet M16x1.5 (tube ø 10mm) bypass nozzle ø 0.35mm gas outlet M16x1.5 (tube ø 10/8mm) thermocouple connection M10x1 pilot connection M10x1 shaft ø 8x6.5mm shaft L 22/15mm shaft flat lower		
	Part No.	101460	Ref. No. —
	O-ring ø 12.37mm D1 ø 2.62mm suitable for PEL22		
	Part No.	101461	Ref. No. —
	screw kit suitable for PEL22 Qty 4 pcs		

Table continues overleaf





accessories for	106027		
	Part No.	106165	Ref. No. —
	gasket ø 27mm		
	Part No.	110079	Ref. No. —
	knob dial plate gas thermostat 1-8 silver		
	Part No.	110080	Ref. No. —
	knob ø 70mm shaft ø 10x8mm shaft flat universal		

gas valves and ignition boxes

gas control valves

HONEYWELL

	1		
Part No.	102320	Ref. No.	151605
description	gas valve type VK4105Q 220-240V 50/60Hz gas inlet flange 32x32mm gas outlet flange 32x32mm thermocouple connection pilot connection pressure range 15-60mbar max 60mbar operator type HONEYWELL coil type 220/240V (V4336A 2212 1) flange 32x32mm		
For models:	PGP608, PGP618, PGP908, PGP918		
accessories for	102320		
	Part No.	102845	Ref. No. —
	gas connection angled 1/2" flange 32x32mm hole distance 24x24mm Tandem		
	Part No.	102846	Ref. No. —
	gas connection straight 1/2" flange 32x32mm hole distance 24x24mm suitable for Tandem		

ROBERTSHAW

electric controlled valves



	1		
Part No.	101388	Ref. No.	173242
description	gas valve supply 220-240VAC supplyVDC 50/60Hz gas inlet 3/4" NPT gas outlet 3/4" NPT thermocouple connection 11/32" pilot connection 1/4" CCT type U7000ER-240--S7CL/s pressure controller natural gas 6.7" W.C. suitable for ROBERTSHAW		
For models:	NGR150, NGR250, NGR300, NGR400		
spare parts for	101388		
	Part No.	101047	Ref. No. —
	magnet unit T1: ASA 11/32 T2: M24x1 L 59mm ø 4mm suitable for ROBERTSHAW		
	Part No.	580033	Ref. No. —
	knob suitable for ROBERTSHAW		
accessories for	101388		
	Part No.	102122	Ref. No. —
	thermocouple ROBERTSHAW ASA 11/32 L 18" - 455mm 7/16"		
	Part No.	102277	Ref. No. —
	thermocouple ROBERTSHAW ASA 11/32 L 36" - 915mm 7/16"		

SIT

ELETTROSIT





	1		
Part No.	101518	Ref. No.	173243
description	gas valve SIT type ELETTROSIT 230V gas inlet 3/4" gas outlet 3/4" thermocouple connection ASA 11/32 pilot connection M10x1 lateral equiv. no. 0.810.200		
For models:	CBG110, CBG120, CGD110, CGD120, NGR150, NGR250, NGR300, NGR400, NGS040, NGS060, NGS080, NGS100, NGS150		
spare parts for	101518		
	Part No.	100006	Ref. No. —
	piezoelectric igniter suitable for ELETTROSIT body plastic blowing connection ø2.4mm ø 14mm		

Table continues overleaf





spare parts for		101518	
	Part No.	101312	Ref. No. —
	microswitch		
	Part No.	101352	Ref. No. —
	solenoid coil 230V 50Hz suitable for ELETTROSIT		
accessories for		101518	
	Part No.	100905	Ref. No. —
	locking screw M10x1 for pipe ø 6mm Qty 1 pcs		
	Part No.	101301	Ref. No. —
	gas connection thread 1/2" straight ELETTROSIT screw with O-ring		
	Part No.	101303	Ref. No. —
	gas connection straight thread 3/4" ELETTROSIT		
	Part No.	101309	Ref. No. —
	extension		

TANDEM



1

Part No.	101985	Ref. No.	150126
description	gas valve pilot connection M10x1 pressure range 6-50mbar power supply for modulator 230VAC rectified type 836021 series Tandem		
For models:	EGP500, FGR150, FGR250, FGR300, FGR400, FGS040, FGS060, FGS080, FGS100, FGS150, PGS048, PGS068, PGS088		
spare parts for		101985	
	Part No.	101379	Ref. No. —
	solenoid coil 230V 50Hz suitable for Tandem		
accessories for		101985	
	Part No.	100904	Ref. No. 178462
	locking screw M10x1 for pipe ø 4mm Qty 1 pcs		
	Part No.	100905	Ref. No. —
	locking screw M10x1 for pipe ø 6mm Qty 1 pcs		
	Part No.	101274	Ref. No. —
	olive for pipe ø 16mm Qty 1 pcs		
	Part No.	101275	Ref. No. —
	union screw thread 1/2" for pipe ø 16mm Qty 1 pcs		
	Part No.	101925	Ref. No. —
	plug with O-ring thread M10x1 for pilot burner suitable for NOVASIT		
	Part No.	102845	Ref. No. —
	gas connection angled 1/2" flange 32x32mm hole distance 24x24mm Tandem		

accessories for		101985	
	Part No.	102846	Ref. No. —
	gas connection straight 1/2" flange 32x32mm hole distance 24x24mm suitable for Tandem		
	Part No.	102847	Ref. No. —
	O-ring		

ignition boxes

HONEYWELL



1

Part No.	101166	Ref. No.	540409
description	ignition box HONEYWELL type S4560B 1006 electrodes 1 waiting time 0s safety time 10s 220-240V 10VA 50Hz		



1

Part No.	102318	Ref. No.	164844
description	ignition box HONEYWELL type S4565AF 1007V01 electrodes 2 waiting times safety time 10s 220-240V 4VA 50/60Hz		
For models:	PGP608, PGP618, PGP908, PGP918		



1

Part No.	106639	Ref. No.	540353
description	ignition box HONEYWELL type S4565P 2024 electrodes 2 waiting times safety time 25s 220-240V 4VA 50/60Hz		



SIT



1

Part No.	101683	Ref. No.	164859
description	ignition box SIT type 503EFD electrodes 2 waiting time 1.5s safety time 10s 220/240V 7VA 50-60Hz		
For models:	EGP500, FGR150, FGR250, FGR300, FGR400, FGS040, FGS060, FGS080, FGS100, FGS150, PGS048, PGS068, PGS088		

gas solenoid valves

DUNGS



1

Part No.	106965	Ref. No.	173142
description	gas valve 230VAC DN 20mm connection 3/4" L 100mm DUNGS p max 0.36bar type MVD207/5 50/60Hz		
For models:	CBG110, CBG120, CGD110, CGD120, EGS060, NGS040, NGS060, NGS080, NGS100, NGS150		

KROMSCHRÖDER



1

Part No.	101986	Ref. No.	173142 (alt)
description	solenoid valve 230V		

ignition parts













pilot burners

SIT

140 - 145 - 150 series



1

Part No.	102831	Ref. No.	540450	
description	pilot burner SIT type 140 series 2 flames nozzle ømm gas connectionmm			
spare parts for	102831			
	Part No.	100701	Ref. No.	—
	ignition electrode connection M4 Qty 1 pcs			
	Part No.	100906	Ref. No.	—
	screw connection thread M10x1 for ignition electrode brass Qty 1 pcs WS 10			
	Part No.	100907	Ref. No.	—
	screw connection thread M10x1 Qty 1 pcs type SEF 1 ømm for thermocouple			
accessories for	102831			
	Part No.	100204	Ref. No.	—
	pilot burner nozzle SIT LPG code 14 bore ø 0.18/0.20mm Qty 1 pcs suitable for 140 series			
	Part No.	100205	Ref. No.	—
	pilot burner nozzle SIT LPG code 19 bore ø 0.23/0.26mm Qty 1 pcs suitable for SIT 150 series			
	Part No.	100206	Ref. No.	—
	pilot burner nozzle SIT natural gas code 36 bore ø 0.60/0.55mm Qty 1 pcs suitable for SIT 150 series			
	Part No.	100207	Ref. No.	—
	pilot burner nozzle SIT natural gas code 27 bore ø 0.40/0.38mm suitable for SIT 140 series			
	Part No.	100216	Ref. No.	—
	pilot burner nozzle SIT natural gas code 38 bore ø 0.45mm Qty 1 pcs suitable for SIT 150 series			
	Part No.	100897	Ref. No.	—
	olive for pipe ø 4mm Qty 1 pcs for pilot burner			
	Part No.	100898	Ref. No.	—
	olive for pipe ø 6mm Qty 1 pcs for pilot burner			
	Part No.	100908	Ref. No.	—
	union screw thread M10x1 for pipe ø 4mm Qty 1 pcs			
	Part No.	100909	Ref. No.	—
	union screw thread M10x1 for pipe ø 6mm Qty 1 pcs			









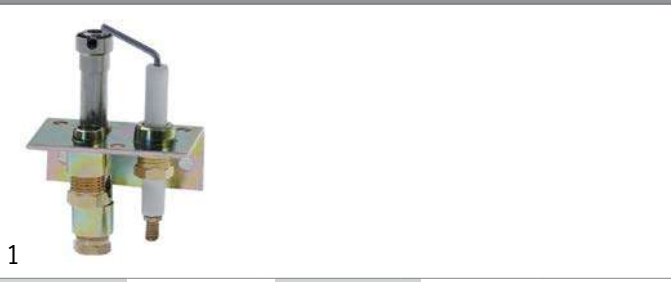









JUNKERS

CB 502 series

pilot burners



Part No.	100062	Ref. No.	270503 356180
description	pilot burner JUNKERS type CB502021 natural gas nozzle no.6 gas connection 6mm with primary air		
For models:	GWN101, GWN201		
spare parts for	100062		
	Part No.	100227	Ref. No. —
	pilot burner nozzle natural gas gas pressure 25mbar code 6 Qty 1 pcs suitable for JUNKERS CB50203_		
	Part No.	100719	Ref. No. —
	ignition electrode D1 ø 7mm D2 ø 9mm connection M4 L1 12mm L2 17mm BL1 18mm BL2 3mm BL3 23mm		
	Part No.	100907	Ref. No. —
	screw connection thread M10x1 Qty 1 pcs type SEF 1 ømm for thermocouple		
	Part No.	100909	Ref. No. —
	union screw thread M10x1 for pipe ø 6mm Qty 1 pcs		
	Part No.	101287	Ref. No. —
	olive for pipe ø 6mm Qty 1 pcs		
	Part No.	101291	Ref. No. —
	screw connection for igniter		
accessories for	100062		
	Part No.	100220	Ref. No. 161141
	pilot burner nozzle LPG gas pressure 50mbar code 2 Qty 1 pcs suitable for JUNKERS CB503_		
	Part No.	100221	Ref. No. —
	pilot burner nozzle LPG gas pressure 30mbar code 29 Qty 1 pcs suitable for JUNKERS CB50203_		
	Part No.	100222	Ref. No. 161149
	pilot burner nozzle LPG gas pressure 50mbar code 5 Qty 1 pcs suitable for JUNKERS CB50203_		
	Part No.	100223	Ref. No. 161140
	pilot burner nozzle natural gas gas pressure 20mbar code 3 Qty 1 pcs suitable for JUNKERS CB503_		
	Part No.	100224	Ref. No. —
	pilot burner nozzle natural gas gas pressure 25mbar code 26 Qty 1 pcs suitable for JUNKERS CB503_		
	Part No.	100225	Ref. No. —
	pilot burner nozzle LPG gas pressure 30mbar code 39 Qty 1 pcs suitable for JUNKERS CB503_		
	Part No.	100226	Ref. No. —
	pilot burner nozzle LPG gas pressure 50mbar code 15 suitable for JUNKERS		
	Part No.	100228	Ref. No. —
	pilot burner nozzle town gas gas pressure 8mbar code 4 Qty 1 pcs suitable for JUNKERS CB50203_		







accessories for	100062		
	Part No.	101281	Ref. No. —
	olive for pipe ø 4mm L 8.7mm Qty 1 pcs suitable for CB 502/503		
	Part No.	101283	Ref. No. —
	union screw thread M10x1 for pipe ø 4mm Qty 1 pcs		



Part No.	100085	Ref. No.	161134 161149 161234
description	pilot burner JUNKERS type CB502031 natural gas nozzle no.6 gas connection 6mm with primary air		
For models:	CBG110, CBG120, CGD110, CGD120, EGB230, EGB430, EGF124, EGF224, EGS060, FGH500, FGH507, FGW250, GPN402, GPP202, GWN101, GWN201, GWN202, LGB430, LGF124, LGF224, LGG420, LGP400, LGS060, NGB430, NGF224, NGG420, NGH500, NGH503, NGH505, NGH507, NGH720, NGH723, NGH725, NGH727, NGH730, NGH733, NGH737, NGP400, NGP600, NGP900, NGS040, NGS060, NGS080, NGS100, NGS150, NGW250, NGW450, PGB438, PGF148, PGF228...(Other models you can see in the webshop)		
spare parts for	100085		
	Part No.	100227	Ref. No. —
	pilot burner nozzle natural gas gas pressure 25mbar code 6 Qty 1 pcs suitable for JUNKERS CB50203_		
	Part No.	100704	Ref. No. 407123
	ignition electrode D1 ø 9mm connection M4 D2 ø 11mm L1 17mm L2 17mm BL1 13mm BL2 4mm BL3 22mm		
	Part No.	100909	Ref. No. —
	union screw thread M10x1 for pipe ø 6mm Qty 1 pcs		
	Part No.	101287	Ref. No. —
	olive for pipe ø 6mm Qty 1 pcs		
	Part No.	101292	Ref. No. —
	union screw for igniter suitable for CB 502/505 Qty 1 pcs		
	Part No.	101295	Ref. No. —
	clamping collet for thermocouple suitable for CB 502/505 Qty 1 pcs		
accessories for	100085		
	Part No.	100220	Ref. No. 161141
	pilot burner nozzle LPG gas pressure 50mbar code 2 Qty 1 pcs suitable for JUNKERS CB503_		
	Part No.	100221	Ref. No. —
	pilot burner nozzle LPG gas pressure 30mbar code 29 Qty 1 pcs suitable for JUNKERS CB50203_		
	Part No.	100222	Ref. No. 161149
	pilot burner nozzle LPG gas pressure 50mbar code 5 Qty 1 pcs suitable for JUNKERS CB50203_		
	Part No.	100223	Ref. No. 161140
	pilot burner nozzle natural gas gas pressure 20mbar code 3 Qty 1 pcs suitable for JUNKERS CB503_		

Table continues overleaf











accessories for		100085		
Part No.		100224	Ref. No.	—
	pilot burner nozzle natural gas gas pressure 25mbar code 26 Qty 1 pcs suitable for JUNKERS CB503_			
	pilot burner nozzle LPG gas pressure 30mbar code 39 Qty 1 pcs suitable for JUNKERS CB503_			
	pilot burner nozzle LPG gas pressure 50mbar code 15 suitable for JUNKERS			
	pilot burner nozzle town gas gas pressure 8mbar code 4 Qty 1 pcs suitable for JUNKERS CB50203_			
	olive for pipe ø 4mm L 8.7mm Qty 1 pcs suitable for CB 502/503			
	union screw thread M10x1 for pipe ø 4mm Qty 1 pcs			



1

Part No.	100061	Ref. No.	161136 784383
description	pilot burner JUNKERS type CB502031 natural gas nozzle no.6 gas pressure 25mbar gas connection 6mm with primary air code 6		
For models:	GHN201, GHN202, GHN401, GHN402, GHN601, GHN602, GHN801, GHN802, GHO101, NGH200, NGH202, NGH400, NGH403, NGH405, NGH407, NGH600, NGH603, NGH605, NGH607, NGH720, NGH723, NGH725, NGH727		

spare parts for		100061		
Part No.		100227	Ref. No.	—
	pilot burner nozzle natural gas gas pressure 25mbar code 6 Qty 1 pcs suitable for JUNKERS CB50203_			
	union screw thread M10x1 for pipe ø 6mm Qty 1 pcs			
	olive for pipe ø 6mm Qty 1 pcs			
	clamping collet for thermocouple suitable for CB 502/505 Qty 1 pcs			

accessories for		100061		
Part No.		100220	Ref. No.	161141
	pilot burner nozzle LPG gas pressure 50mbar code 2 Qty 1 pcs suitable for JUNKERS CB503_			
	pilot burner nozzle LPG gas pressure 30mbar code 29 Qty 1 pcs suitable for JUNKERS CB50203_			
	pilot burner nozzle LPG gas pressure 50mbar code 5 Qty 1 pcs suitable for JUNKERS CB50203_			161149
	pilot burner nozzle natural gas gas pressure 20mbar code 3 Qty 1 pcs suitable for JUNKERS CB503_			161140

accessories for		100061		
Part No.		100224	Ref. No.	—
	pilot burner nozzle natural gas gas pressure 25mbar code 26 Qty 1 pcs suitable for JUNKERS CB503_			
	pilot burner nozzle LPG gas pressure 30mbar code 39 Qty 1 pcs suitable for JUNKERS CB503_			
	pilot burner nozzle LPG gas pressure 50mbar code 15 suitable for JUNKERS			
	pilot burner nozzle town gas gas pressure 8mbar code 4 Qty 1 pcs suitable for JUNKERS CB50203_			
	ignition electrode D1 ø 9mm connection M4 D2 ø 11mm L1 17mm L2 17mm BL1 13mm BL2 4mm BL3 22mm	100704	Ref. No.	407123
	cover for pilot burner suitable for JUNKERS CB502_ SS	100851	Ref. No.	808060002
	screw connection thread M10x1 Qty 1 pcs type SEF 1 ømm for thermocouple	100907	Ref. No.	—
	olive for pipe ø 4mm L 8.7mm Qty 1 pcs suitable for CB 502/503	101281	Ref. No.	—
	union screw thread M10x1 for pipe ø 4mm Qty 1 pcs	101283	Ref. No.	—
	union screw for igniter suitable for CB 502/505 Qty 1 pcs	101292	Ref. No.	—

CB 503 series

pilot burners



1











Part No.	100101	Ref. No.	540706	
description	pilot burner JUNKERS type CB503003 LPG nozzle no.2 gas connection 4mm with primary air			
spare parts for	100101			
	Part No.	100224	Ref. No.	—
	Part No.	101281	Ref. No.	—
	Part No.	101283	Ref. No.	—
accessories for	100101			
	Part No.	100220	Ref. No.	161141
	pilot burner nozzle LPG gas pressure 50mbar code 2 Qty 1 pcs suitable for JUNKERS CB503_			

Table continues overleaf



accessories for		100101		
	Part No.	100221	Ref. No.	—
	pilot burner nozzle LPG gas pressure 30mbar code 29 Qty 1 pcs suitable for JUNKERS CB50203_			
	Part No.	100222	Ref. No.	161149
	pilot burner nozzle LPG gas pressure 50mbar code 5 Qty 1 pcs suitable for JUNKERS CB50203_			
	Part No.	100223	Ref. No.	161140
	pilot burner nozzle natural gas gas pressure 20mbar code 3 Qty 1 pcs suitable for JUNKERS CB503_			
	Part No.	100226	Ref. No.	—
	pilot burner nozzle LPG gas pressure 50mbar code 15 suitable for JUNKERS			
	Part No.	100227	Ref. No.	—
	pilot burner nozzle natural gas gas pressure 25mbar code 6 Qty 1 pcs suitable for JUNKERS CB50203_			
	Part No.	100228	Ref. No.	—
	pilot burner nozzle town gas gas pressure 8mbar code 4 Qty 1 pcs suitable for JUNKERS CB50203_			
	Part No.	100909	Ref. No.	—
	union screw thread M10x1 for pipe ø 6mm Qty 1 pcs			
	Part No.	101287	Ref. No.	—
	olive for pipe ø 6mm Qty 1 pcs			
	Part No.	102110	Ref. No.	—
	pilot tube copper pipe ø 4mm thickness 1mm L 3000mm			
	Part No.	102111	Ref. No.	—
	pilot tube copper pipe ø 6mm thickness 1mm L 3000mm			

				
1				
Part No.	100058	Ref. No.	161139	
description	pilot burner JUNKERS type CB503006 natural gas nozzle no.26 gas connection 4mm			
For models:	EGH417, EGH617, FGH417, FGH507, FGH617, GHN201, GHN202, GHN401, GHN402, GHN601, GHN602, GHN801, GHN802, LGH407, NGH407, NGH417, NGH507, NGH607, NGH617, NGH727, NGH737			
spare parts for	100058			
	Part No.	100224	Ref. No.	—
	pilot burner nozzle natural gas gas pressure 25mbar code 26 Qty 1 pcs suitable for JUNKERS CB503_			
	Part No.	101281	Ref. No.	—
	olive for pipe ø 4mm L 8.7mm Qty 1 pcs suitable for CB 502/503			
	Part No.	101283	Ref. No.	—
	union screw thread M10x1 for pipe ø 4mm Qty 1 pcs			
accessories for	100058			
	Part No.	100220	Ref. No.	161141
	pilot burner nozzle LPG gas pressure 50mbar code 2 Qty 1 pcs suitable for JUNKERS CB503_			
	Part No.	100221	Ref. No.	—
	pilot burner nozzle LPG gas pressure 30mbar code 29 Qty 1 pcs suitable for JUNKERS CB50203_			

accessories for		100058		
	Part No.	100222	Ref. No.	161149
	pilot burner nozzle LPG gas pressure 50mbar code 5 Qty 1 pcs suitable for JUNKERS CB50203_			
	Part No.	100223	Ref. No.	161140
	pilot burner nozzle natural gas gas pressure 20mbar code 3 Qty 1 pcs suitable for JUNKERS CB503_			
	Part No.	100226	Ref. No.	—
	pilot burner nozzle LPG gas pressure 50mbar code 15 suitable for JUNKERS			
	Part No.	100227	Ref. No.	—
	pilot burner nozzle natural gas gas pressure 25mbar code 6 Qty 1 pcs suitable for JUNKERS CB50203_			
	Part No.	100228	Ref. No.	—
	pilot burner nozzle town gas gas pressure 8mbar code 4 Qty 1 pcs suitable for JUNKERS CB50203_			
	Part No.	100909	Ref. No.	—
	union screw thread M10x1 for pipe ø 6mm Qty 1 pcs			
	Part No.	101287	Ref. No.	—
	olive for pipe ø 6mm Qty 1 pcs			
	Part No.	102110	Ref. No.	—
	pilot tube copper pipe ø 4mm thickness 1mm L 3000mm			
	Part No.	102111	Ref. No.	—
	pilot tube copper pipe ø 6mm thickness 1mm L 3000mm			

CB 505 series

pilot burners









				
1				
Part No.	100119	Ref. No.	161193	
description	pilot burner JUNKERS type CB505141 natural gas nozzle no.45 gas connection 4mm			
For models:	NGF144, NGR150, NGR250, NGR300, NGR400			
spare parts for	100119			
	Part No.	100213	Ref. No.	—
	pilot burner nozzle natural gas code 45 gas pressure 20mbar L 16mm Qty 1 pcs suitable for JUNKERS CB5051_			
	Part No.	101282	Ref. No.	—
	olive for pipe ø 4mm L 7.4mm Qty 1 pcs			
	Part No.	101283	Ref. No.	—
	union screw thread M10x1 for pipe ø 4mm Qty 1 pcs			
	Part No.	101292	Ref. No.	—
	union screw for igniter suitable for CB 502/505 Qty 1 pcs			
	Part No.	101295	Ref. No.	—
	clamping collet for thermocouple suitable for CB 502/505 Qty 1 pcs			
	Part No.	102842	Ref. No.	—
	gasket for pilot burner 65x18			

Table continues overleaf



accessories for		100119	
	Part No.	100210	Ref. No. —
pilot burner nozzle LPG code 46 gas pressure 30mbar L 16mm Qty 1 pcs suitable for JUNKERS CB5051_			
	Part No.	100211	Ref. No. —
pilot burner nozzle natural gas code 44 gas pressure 25mbar L 16mm Qty 1 pcs suitable for JUNKERS CB5051_			
	Part No.	100212	Ref. No. —
pilot burner nozzle LPG code 42 gas pressure 50mbar L 16mm Qty 1 pcs suitable for JUNKERS CB5051_			
	Part No.	100909	Ref. No. —
union screw thread M10x1 for pipe ø 6mm Qty 1 pcs			
	Part No.	101288	Ref. No. —
olive for pipe ø 6mm L 6mm aluminium Qty 1 pcs ED ø 8.5mm			
	Part No.	102842	Ref. No. —
gasket for pilot burner 65x18			

producer-specific pilot burners

KÜPPERSBUSCH

EGH_ series (version 1)



Part No.	102956	Ref. No.	-
description	pilot burner type C without nozzle		



Part No.	102957	Ref. No.	-
description	pilot burner type D without nozzle		



Part No.	102958	Ref. No.	-
description	pilot burner type E without nozzle		









NGH_ series (version 2) / PGH_ (version 1)



Part No.	107472	Ref. No.	-
description	pilot burner complete natural/liquid gas gas line ø 4mm		
accessories for	107472		
	Part No.	803031	Ref. No. —
nut spinner size 5.5mm total length 236mm blade length 125mm			

FGH_ / EGH_ (version 2) / PGH_ series (version 2)



Part No.	101529	Ref. No.	154115
description	pilot burner type E incl. nozzles 0.18mm / 0.20mm / 0.32mm / 0.35mm		
For models:	EGH210, EGH410, EGH413, EGH417, EGH610, EGH613, EGH617, FGH210, FGH410, FGH413, FGH415, FGH417, FGH610, FGH613, FGH615, FGH617, PGH218, PGH418, PGH618		
spare parts for	101529		
	Part No.	100235	Ref. No. 152693
pilot burner nozzle LPG bore ø 0.2mm code 20 gas pressure 50mbar thread M5x0.8			
	Part No.	100236	Ref. No. 152695
pilot burner nozzle natural gas bore ø 0.35mm code 35 gas pressure 20mbar thread M5x0.8 WS 5.5			
	Part No.	100900	Ref. No. —
air mixing sleeve for pilot burner Qty 1 pcs			
	Part No.	101583	Ref. No. 154111 154112
pilot burner head slit width 0.8mm bore ø 3mm ø 6mm M7x0.75mm total length 22mm WS 8 nickel-plated brass			
	Part No.	101587	Ref. No. 060328
gasket for pilot burner without ignition electrode			
	Part No.	101588	Ref. No. —
pilot burner nozzle natural gas bore ø 0.32mm code 32 gas pressure 20mbar thread M5x0.8			
	Part No.	101589	Ref. No. —
pilot burner nozzle LPG bore ø 0.18mm code 18 gas pressure 50mbar thread M5x0.8 WS 5.5			
	Part No.	101848	Ref. No. 135690
cover for pilot burner			



accessories universal

covers



Part No.	101926	Ref. No.	735918000
description	cover for pilot burner suitable for KÜPPERSBUSCH		
For models:	EGS060, NGS040, NGS060, NGS080, NGS100, NGS150		

electrodes

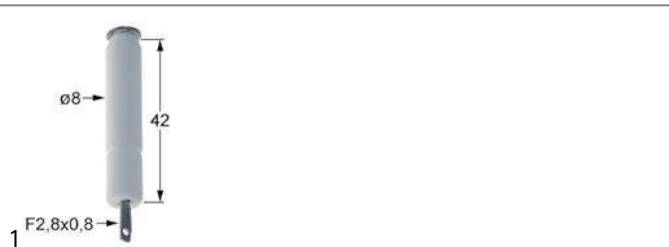

Part No.	100720	Ref. No.	185217
description	ignition electrode D1 \varnothing 8mm BL1 42mm connection F 2.8x0.8mm with spring		
For models:	GHP601, LGH405, LGH407, LGH605, LGH607		

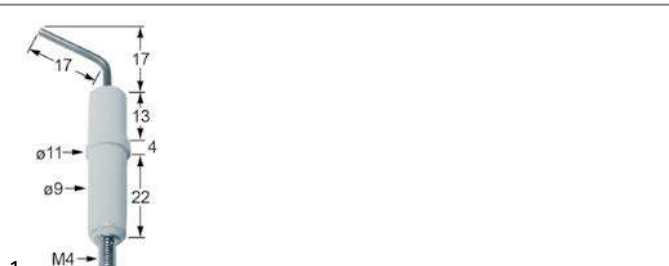

Part No.	100704	Ref. No.	407123
description	ignition electrode D1 \varnothing 9mm connection M4 D2 \varnothing 11mm L1 17mm L2 17mm BL1 13mm BL2 4mm BL3 22mm		

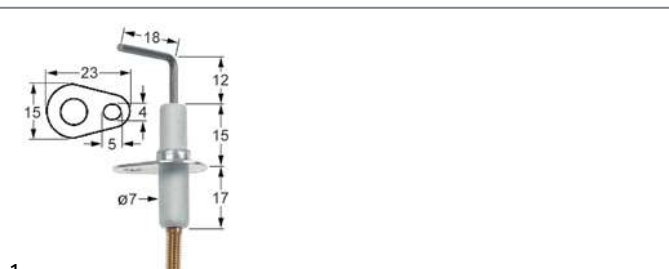

Part No.	101782	Ref. No.	162800
description	ignition electrode flange length 23mm flange width 16mm D1 \varnothing 7mm L1 12mm L2 18mm BL1 15mm BL2 16mm connection M4 fixing dimensions \varnothing 4.5mm with flange		
For models:	EGH417, EGH617, FGH417, FGH507, FGH617, NGH417, NGH507, NGH617, NGH737		

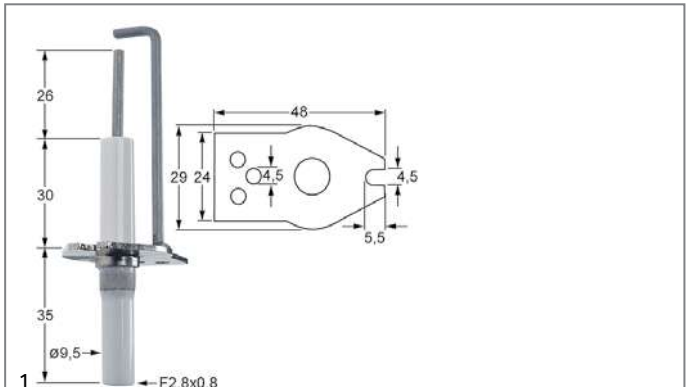

Part No.	101783	Ref. No.	162805
description	ignition electrode flange length 48mm flange width 1 29mm flange width 2 24mm D1 \varnothing 9.5mm L1 26mm BL1 30mm BL2 35mm connection F 2.8x0.8mm fixing dimensions \varnothing 5.5x4.5mm/ \varnothing 4.5mm with flange with earthing contact		
For models:	EGP500, FGS040, FGS060, FGS080, FGS100, FGS150, PGS048, PGS068, PGS088		

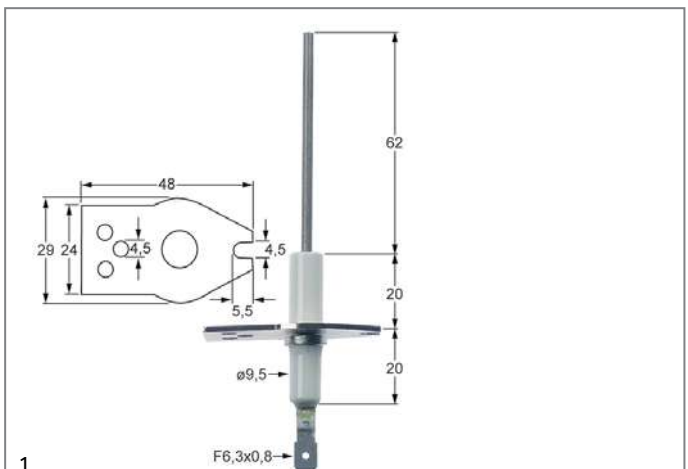

Part No.	101784	Ref. No.	162806
description	ignition electrode flange length 48mm flange width 1 29mm flange width 2 24mm D1 \varnothing 9.5mm L1 62mm BL1 20mm BL2 20mm connection F 6.3x0.8mm fixing dimensions \varnothing 5.5x4.5mm/ \varnothing 4.5mm with flange		
For models:	EGP500, FGS040, FGS060, FGS080, FGS100, FGS150, PGS048, PGS068, PGS088		

ignition cables

pre-assembled cables



Part No.	102172	Ref. No.	784231002 807857002 808857002
description	ignition cable cable length 300mm connection \varnothing 4mm / F6.3mm		
For models:	LGB430, LGG420, NGB430, NGG420		



Part No.	100025	Ref. No.	784231002
description	ignition cable cable length 600mm connection \varnothing 4mm / F6.3mm		



piezoelectric igniters

mounting diameter 18mm



1

Part No.	100004	Ref. No.	540955
description	piezoelectric igniter body plastic blowing mounting ø 18mm connection ø2.4mm		

miscellaneous



1

Part No.	nla ¹	Ref. No.	161161
description	piezoelectric igniter body metal connection F6.3x0.8 2 hole fixing ø 22mm		
For models:	EGB230, EGB430, EGF124, EGF224, EGS060, FGH500, FGH507, GPN402, GPP202, GWN101, GWN201, GWN202, LGB430, LGF124, LGF224, LGG420, LGP400, LGS060, NGB430, NGF144, NGF224, NGG420, NGH500, NGH503, NGH505, NGH507, NGH720, NGH723, NGH725, NGH727, NGH730, NGH733, NGH737, NGP400, NGP600, NGP900, NGS040, NGS060, NGS080, NGS100, NGS150, NGW250, NGW450, PGH508		

¹no longer available

ignition units



1

Part No.	101016	Ref. No.	185310
description	ignition unit outputs 2 230VAC inlet F6.3x0.8 outlet F2.8x0.8 1.7VA 50Hz mounting ø 42mm		
For models:	CBG110, CBG120, CGD110, CGD120, NGR150, NGR250, NGR300, NGR400, NGS040, NGS060, NGS080, NGS100, NGS150		



1

Part No.	101006	Ref. No.	105002 105202 152002 185207 185278 185279
description	ignition unit outputs 6 230VAC inlet F6.3x0.8 outlet F2.8x0.8 without front fixing nut 0.6VA 50Hz mounting ømm		
For models:	GHP601, LGH405, LGH407, LGH605, LGH607		

thermocouples

plug-in thermocouples

plug-in thermocouples standard
with barrel socket ø5mm - type Junkers with aluminised tip



1

Part No.	102211	Ref. No.	174410
description	thermocouple M10x1 L 320mm plug connection ø5.0mm		
For models:	GPN402		



1

Part No.	102212	Ref. No.	162164
description	thermocouple M10x1 L 450mm plug connection ø5.0mm		

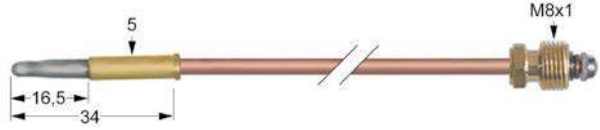

1

Part No.	102140	Ref. No.	162164
description	thermocouple M10x1 L 600mm plug connection ø5.0mm		



1

Part No.	102213	Ref. No.	162164
description	thermocouple M10x1 L 600mm plug connection ø5.0mm		
For models:	EGB230, EGB430, LGP400, NGP400, PGB438		



1

Part No.	102141	Ref. No.	162163
description	thermocouple M10x1 L 750mm plug connection ø5.0mm		



1

Part No.	102214	Ref. No.	162163
description	thermocouple M10x1 L 750mm plug connection ø5.0mm		
For models:	NGP600, NGP900		

1 gas components



Part No.	102009	Ref. No.	174413
description	thermocouple M8x1 L 1000mm plug connection ø5.0mm		

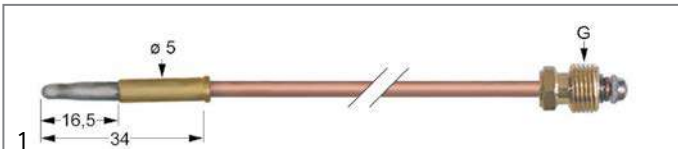

Part No.	102020	Ref. No.	162111
description	thermocouple M8x1 L 320mm plug connection ø5.0mm		

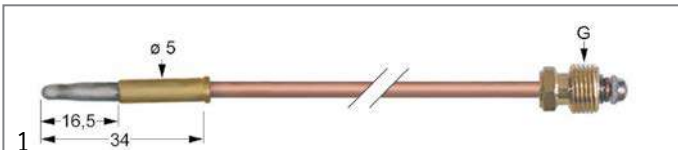

Part No.	102202	Ref. No.	161111 162111 174409 504113 506112
description	thermocouple M8x1 L 320mm plug connection ø5.0mm		

For models: EGB230, EGB430, EGH210, EGH410, EGH413, EGH417, EGH610, EGH613, EGH617, FGH210, FGH410, FGH413, FGH415, FGH417, FGH500, FGH507, FGH610, FGH613, FGH615, FGH617, GHN201, GHN202, GHN401, GHN402, GHN601, GHN602, GHN801, GHN802, GHP601, GPP202, GWN202, LGB430, LGF124, LGF224, LGG420, LGH405, LGH407, LGH605, LGH607, NGB430, NGG420, NGH200, NGH202, NGH400, NGH403, NGH405, NGH407, NGH500, NGH503, NGH505...(Other models you can see in the webshop)

accessories for	102202		
	Part No.	101260	Ref. No. —
	thermocouple fitting thread M8x1 Qty 1 pcs		

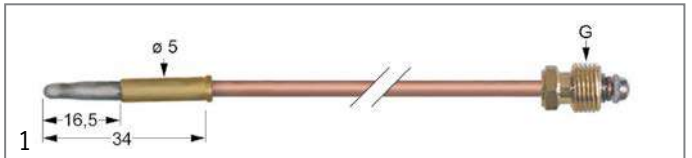

Part No.	102205	Ref. No.	174413
description	thermocouple M8x1 L 750mm plug connection ø5.0mm		
For models:	GHN201, GHN202, GHN401, GHN402, GHN601, GHN602, GHN801, GHN802, NGH200, NGH202, NGH400, NGH403, NGH405, NGH407, NGH600, NGH603, NGH605, NGH607, NGH720, NGH723, NGH725, NGH727		
accessories for	102205		
	Part No.	101260	Ref. No. —
	thermocouple fitting thread M8x1 Qty 1 pcs		

with barrel socket ø6mm
type Junkers with aluminised tip

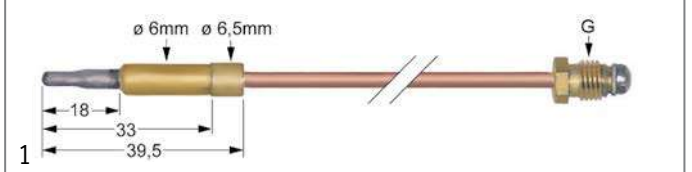

Part No.	102256	Ref. No.	162161
description	thermocouple ASA 11/32 L 1000mm plug connection ø6.0mm		
For models:	NGR150		

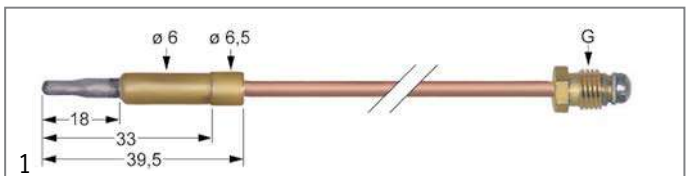

Part No.	102027	Ref. No.	162138
description	thermocouple M10x1 L 1500mm plug connection ø6.0mm		

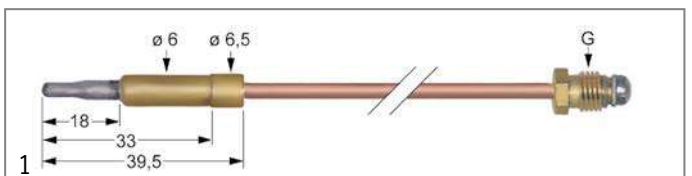

Part No.	102231	Ref. No.	162138
description	thermocouple M10x1 L 1500mm plug connection ø6.0mm		

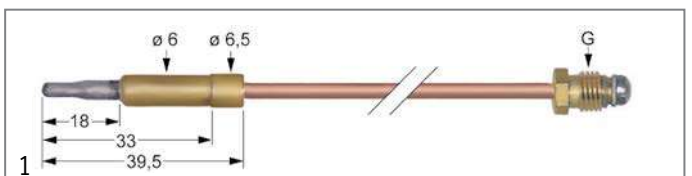

Part No.	102228	Ref. No.	162134
description	thermocouple M10x1 L 750mm plug connection ø6.0mm		



Part No.	102223	Ref. No.	162142 162143 162152 162155
description	thermocouple M8x1 L 1200mm plug connection $\varnothing 6.0$ mm		
For models:	EGH417, EGH617, GHN401, GHN402, GHN601, GHN602, GHN801, GHN802, GHP601		

Part No.	102218	Ref. No.	162132 162139 356251
description	thermocouple M8x1 L 320mm plug connection $\varnothing 6.0$ mm		

Part No.	102219	Ref. No.	162132 356250
description	thermocouple M8x1 L 450mm plug connection $\varnothing 6.0$ mm		

Part No.	102220	Ref. No.	162140
description	thermocouple M8x1 L 600mm plug connection $\varnothing 6.0$ mm		
For models:	GPN402, GWN101, GWN201		

with barrel socket $\varnothing 6(6.5)$ mm

thermocouples SIT

Part No.	107621	Ref. No.	162138
description	thermocouple SIT M10x1 L 1500mm plug connection $\varnothing 6.0(6.5)$ mm		
For models:	EGH417, EGH617, FGH417, FGH507, FGH617, LGH407, LGH607, NGH407, NGH417, NGH507, NGH607, NGH617, NGH727, NGH737		

threaded thermocouples (miscellaneous)

Part No.	107461	Ref. No.	162112
description	thermocouple M8x1 L 600mm plug connection $\varnothing 5.0$ mm		
For models:	EGH210, EGH410, EGH413, EGH417, EGH610, EGH613, EGH617, FGH210, FGH410, FGH413, FGH415, FGH417, FGH610, FGH613, FGH615, FGH617, GHP601, LGH405, LGH407, LGH605, LGH607, NGF144, NGF224, PGH218, PGH418, PGH618		

plug-in thermocouples with cable link

Part No.	102814	Ref. No.	941066002 994544002
description	thermocouple L 1000mm plug connection $\varnothing 5.0$ mm F 6.3mm M5		
For models:	CBG110, CBG120, CGD110, CGD120, NGS040, NGS060, NGS080, NGS100, NGS150		

Part No.	102131	Ref. No.	162166
description	thermocouple with two-conductors L 1000mm plug connection $\varnothing 5.0$ mm M8x1		
For models:	EGF124, EGF224, NGF144, NGF224		

Part No.	102255	Ref. No.	996206002
description	thermocouple with two-conductors L 600mm plug connection $\varnothing 5.0$ mm F 6.3mm M5		
For models:	FGW250, PGF148, PGF228, PGW458		

Part No.	102089	Ref. No.	162168
description	thermocouple with two-conductors L 600mm plug connection $\varnothing 5.0$ mm M8x1		



plug-in thermocouples with interruption

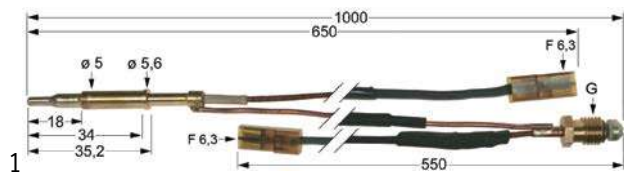

Part No.	102815	Ref. No.	942740002
description	thermocouple with interrupter M8x1 L 1000mm plug connection ø5.0mm F 6.3mm		
For models:	EGS060		

threaded thermocouples

threaded thermocouples standard

with socket with thread M8x1

SIT

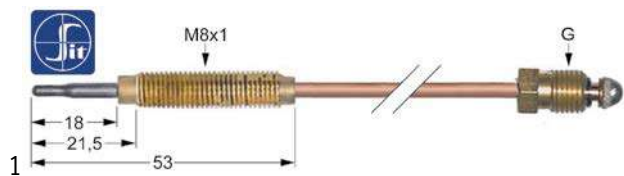

Part No.	107627	Ref. No.	162123
description	thermocouple SIT M8x1 L 220mm M8x1		

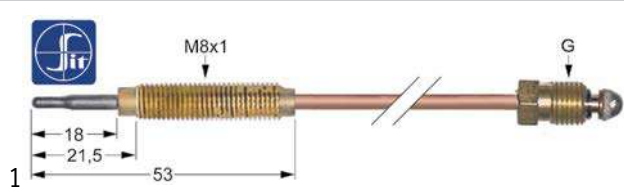

Part No.	107628	Ref. No.	151900
description	thermocouple SIT M8x1 L 320mm M8x1		

accessories for	107628			
	Part No.	102067	Ref. No.	—
	nut thread M8x1 H 3mm brass Qty 1 pcs type SEF 1			

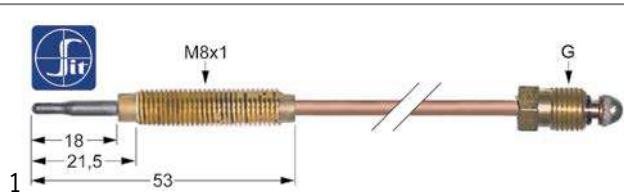

Part No.	107629	Ref. No.	162124
description	thermocouple SIT M8x1 L 450mm M8x1		

type Junkers with aluminised tip

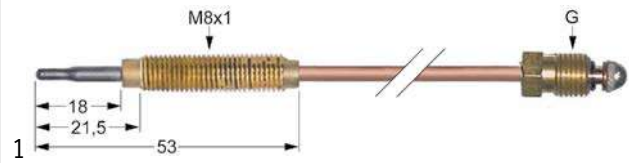

Part No.	102233	Ref. No.	151901
description	thermocouple M8x1 L 750mm M8x1		
For models:	NGH210, NGH410, NGH413, NGH415, NGH417, NGH610, NGH613, NGH615, NGH617, NGH730, NGH733, NGH737, PGH218, PGH418, PGH618		

accessories for	102233			
	Part No.	102067	Ref. No.	—
	nut thread M8x1 H 3mm brass Qty 1 pcs type SEF 1			

accessories

display adapters



Part No.	100947	Ref. No.	174757
description	display adapter thread M8x1		

interrupters



Part No.	580046	Ref. No.	174463
description	extension for interrupter L 18" - 455mm		
For models:	NGR150, NGR250, NGR300, NGR400		



Part No.	101258	Ref. No.	164833
description	interrupter thread M10x1		
For models:	NGP600, NGP900		



Part No.	101264	Ref. No.	164815
description	interrupter thread M8x1		
For models:	EGB230, EGB430, EGF124, EGF224, EGH417, EGH617, FGH417, FGH507, FGH617, FGW250, PGB438, PGF148, PGF228, PGW458		



			
1			
Part No.	101265	Ref. No.	183235
description	interrupter thread M9x1		
For models:	CBG110, CBG120, CGD110, CGD120, NGR150, NGR250, NGR300, NGR400, NGS040, NGS060, NGS080, NGS100, NGS150		

gas burners

hob burners

accessories

reducers for pan supports

			
1			
Part No.	210050	Ref. No.	N/A
description	reducer for pan support L 260mm W 260mm chrome-plated steel suitable for universal		

			
1			
Part No.	210001	Ref. No.	N/A
description	reducer for pan support L 265mm W 265mm SS suitable for universal		

simmering plates

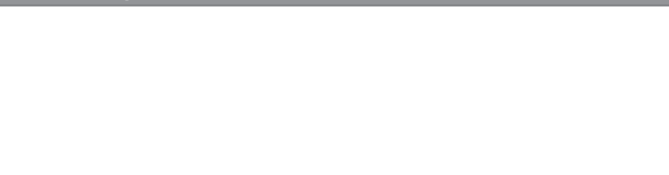
			
1			
Part No.	211044	Ref. No.	160613
description	simmer plate		
For models:	EEH210, EEH410, EEH413, EEH610, EEH613		

bar burners

bar burners

			
1			
Part No.	105617	Ref. No.	995546511
description	bar burner		
For models:	NGP600		

			
1			
Part No.	105612	Ref. No.	808250002
description	bar burner fryer		
For models:	NGF144		

			
1			
Part No.	104166	Ref. No.	164401
description	bar burner ø 50mm Wmm Hmm L 600mm with bolt M5x12 flange width 57mm flange length 57mm kettle		
For models:	CBG110, CBG120, CGD110, CGD120, FGR150, FGR250, FGR300, FGR400, NGR250, NGR300, NGR400		

			
1			
Part No.	105613	Ref. No.	995789002
description	bar burner ø 60mm Wmm Hmm L 240mm fryer		
For models:	PGF148		

			
1			
Part No.	104179	Ref. No.	8079590002
description	bar burner ø 60mm Wmm Hmm L 362mm kettle		





			
1			
Part No.	105619	Ref. No.	985811002
description	bar burner ø 60mm Wmm Hmm L 505mm kettle		
For models:	NGR150, NGR250, NGR300, NGR400		

			
1			
Part No.	104177	Ref. No.	807528002
description	bar burner ømm W 30mm H 51mm L 425mm griddle		
For models:	NGB430, NGG420		

			
1			
Part No.	104180	Ref. No.	807275002
description	bar burner ø 60mm Wmm Hmm L 585mm kettle		
For models:	FGS080, FGS100, NGS080, NGS100, PGS088		

			
1			
Part No.	105607	Ref. No.	996804002
description	bar burner ømm W 30mm H 51mm L 585mm griddle		
For models:	PGB438		

			
1			
Part No.	104181	Ref. No.	807276002
description	bar burner ø 60mm Wmm Hmm L 600mm kettle		
For models:	FGS150, NGS150		

			
1			
Part No.	105614	Ref. No.	996072002
description	bar burner ømm W 40mm H 55mm L 330mm fryer		
For models:	PGF228		

			
1			
Part No.	105905	Ref. No.	541545
description	bar burner ømm W 28mm H 42mm L 295mm flange width 35mm flange length 70mm kettle		

			
1			
Part No.	104380	Ref. No.	807612002
description	bar burner ømm W 41mm H 56mm L 216mm fryer		
For models:	EGF124, EGF224, LGF124, LGF224, NGF224		

			
1			
Part No.	105610	Ref. No.	807288002
description	bar burner ømm W 30mm H 51mm L 425mm bain marie		
For models:	FGW250, NGW250, PGW458		

			
1			
Part No.	104176	Ref. No.	807286002
description	bar burner ømm W 41mm H 56mm L 505mm solid top		
For models:	FGH500, FGH507, NGH500, NGH503, NGH505, NGH507, NGH720, NGH723, NGH725, NGH727, NGH730, NGH733, NGH737, PGH508		

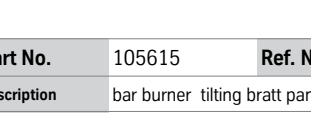

			
1			
Part No.	104178	Ref. No.	807527002
description	bar burner solid top		
For models:	LGB430, LGG420		

			
1			
Part No.	105615	Ref. No.	807628511
description	bar burner tilting bratt pan		
For models:	LGP400, NGP400		

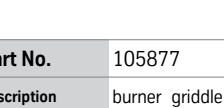
			
1			
Part No.	105877	Ref. No.	Thielmann 193635
description	burner griddle		

			
1			
Part No.	105917	Ref. No.	Thielmann 144615
description	burner ømm tilting bratt pan		

			
1			
Part No.	105919	Ref. No.	541123 rechts Thielmann 144557
description	burner ømm tilting bratt pan		

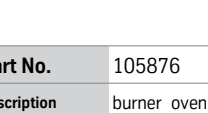
			
1			
Part No.	105876	Ref. No.	Thielmann 193660
description	burner oven		

ring burners

			
1			
Part No.	105604	Ref. No.	807110511
description	ring burner		
For models:	LGH407, LGH607, NGH407, NGH507, NGH607, NGH727		

			
1			
Part No.	104175	Ref. No.	161198 782413005 782413009 807110511
description	ring burner L 470mm W 287mm for oven		

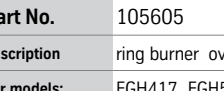
			
1			
Part No.	105605	Ref. No.	782413005
description	ring burner oven		
For models:	FGH417, FGH507, FGH617, NGH417, NGH507, NGH617, NGH737		

accessories

nozzle holders

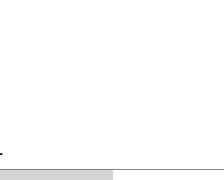
			
1			
Part No.	101548	Ref. No.	161675
description	nozzle holder external nozzle ø bore ø3.00mm internal nozzle ø bore ø1.85mm		
For models:	EGH417, EGH617, LGH407, LGH607		



1			
Part No.	101549	Ref. No.	161676
description	nozzle holder external nozzle \varnothing bore \varnothing 3.00mm internal nozzle \varnothing bore \varnothing 1.95mm		
For models:	NGH407, NGH507, NGH607, NGH727		

2			
Part No.	101539	Ref. No.	152676
description	nozzle holder external nozzle \varnothing bore \varnothing 3.80mm internal nozzle \varnothing bore \varnothing 2.05mm		
For models:	NGH417, NGH507, NGH617, NGH737		

			
1			
Part No.	104503	Ref. No.	540269
description	nozzle holder ID \varnothing 8mm		

gas nozzles

pilot burner nozzles

pilot burner nozzles EGA

			
1			
Part No.	100235	Ref. No.	152693
description	pilot burner nozzle LPG bore \varnothing 0.2mm code 20 gas pressure 50mbar thread M5x0.8		

			
1			
Part No.	100236	Ref. No.	152695
description	pilot burner nozzle natural gas bore \varnothing 0.35mm code 35 gas pressure 20mbar thread M5x0.8 WS 5.5		
For models:	EGH210, EGH410, EGH413, EGH417, EGH610, EGH613, EGH617		

pilot burner nozzles JUNKERS

CB 50203_/503_ series

			
1			
Part No.	100220	Ref. No.	161141
description	pilot burner nozzle LPG gas pressure 50mbar code 2 Qty 1 pcs suitable for JUNKERS CB503_		
For models:	EGH417, EGH617, LGH407, LGH607, NGH200, NGH202, NGH407, NGH500, NGH503, NGH505, NGH507, NGH607, NGH720, NGH723, NGH725, NGH727		

			
1			
Part No.	100222	Ref. No.	161149
description	pilot burner nozzle LPG gas pressure 50mbar code 5 Qty 1 pcs suitable for JUNKERS CB50203_		
For models:	EGB230, EGB430, EGF124, EGF224, GHO101, LGB430, LGF124, LGF224, LGG420, LGP400, LGS060, NGB430, NGF224, NGG420, NGP400, NGW250, NGW450		

			
1			
Part No.	100223	Ref. No.	161140
description	pilot burner nozzle natural gas gas pressure 20mbar code 3 Qty 1 pcs suitable for JUNKERS CB503_		

			
1			
Part No.	102523	Ref. No.	161140
description	pilot burner nozzle natural gas gas pressure 20mbar code 3 Qty 10 pcs suitable for CB 503		
For models:	CEC106, EGB230, EGB430, EGF124, EGF224, EGH417, EGH617, EGS060, FGH417, FGH500, FGH507, FGH617, FGW250, GHO101, LGB430, LGF124, LGF224, LGG420, LGH407, LGP400, LGS060, NGB430, NGF144, NGF224, NGG420, NGH200, NGH202, NGH407, NGH500, NGH503, NGH505, NGH507, NGH607, NGH720, NGH723, NGH725, NGH727, NGP400, NGW250, NGW450, PGB438, PGH508		



pilot burner nozzles SIT

160 series

			
1			
Part No.	107174	Ref. No.	540729
description	pilot burner nozzle SIT natural gas code 41 Qty 1 pcs		

bypass nozzles

bypass nozzles EGA

			
1			
Part No.	106441	Ref. No.	152680
description	bypass nozzle EGA bore ø 1.25mm		

			
1			
Part No.	100354	Ref. No.	163113
description	bypass nozzle EGA type 31248 series bore ø 0.5mm		

			
1			
Part No.	100346	Ref. No.	152681
description	bypass nozzle EGA type 31248 series bore ø 0.85mm		

			
1			
Part No.	100348	Ref. No.	150406
description	bypass nozzle EGA type 31248 series bore ø 1.1mm		

internal nozzles

EGA 26400/26440/23268

			
1			
Part No.	100319	Ref. No.	161790
description	internal nozzle bore ø 0.75mm suitable for EGA26400/26440		
For models:	LGH405, LGH407, LGH605, LGH607		

			
1			
Part No.	100311	Ref. No.	406938
description	internal nozzle bore ø 0.80mm suitable for EGA26400/26440		

			
1			
Part No.	100624	Ref. No.	161791
description	internal nozzle bore ø 0.85mm suitable for EGA26400/26440		
For models:	LGH405, LGH407, LGH605, LGH607		

EGA 26440

			
1			
Part No.	100395 ¹	Ref. No.	152634
description	internal nozzle bore ø 1.4mm suitable for EGA26400/26440		

¹suitable for 101735 and 101653

			
1			
Part No.	100396 ¹	Ref. No.	152635
description	internal nozzle bore ø 1.8mm suitable for EGA26400/26440		

¹suitable for 101736 and 101654

			
1			
Part No.	100397 ¹	Ref. No.	152636
description	internal nozzle bore ø 2.05mm suitable for EGA26400/26440		

¹suitable for 101737 and 101655



auxiliary gas parts

screw connections

olives

			
1			
Part No.	101278	Ref. No.	114101
description	olive for pipe ø 10mm Qty 1 pcs		

For models: EGB230, EGB430, EGF124, EGF224, EGH210, EGH410, EGH413, EGH417, EGH610, EGH613, EGH617, EGP500, FGH210, FGH410, FGH413, FGH415, FGH417, FGH610, FGH613, FGH615, FGH617, KGD131, KGE066, KGE081, KGE131, LGB430, LGF124, LGF224, LGG420, NGB430, NGF144, NGF224, NGG420, NGH200, NGH202, NGH400, NGH403, NGH405, NGH407, NGH507, NGH600, NGH603, NGH605, NGH607, NGH720, NGH723, NGH725, NGH727, NGH730, NGH733... (Other models you can see in the webshop)

accessories for	101278			
	Part No.	100943	Ref. No.	—
	union nut thread M17x1 tube ø 10mm			
	Part No.	101300	Ref. No.	—
	union nut thread M16x1.5 tube ø 10mm			
	Part No.	101478	Ref. No.	—
	union nut thread 3/8" for pipe ø 10mm			

			
1			
Part No.	101284	Ref. No.	114121
description	olive for pipe ø 4mm Qty 1 pcs		

For models: EGB230, EGB430, EGF124, EGF224, EGH210, EGH410, EGH413, EGH417, EGH610, EGH613, EGH617, EGS060, FGH210, FGH410, FGH413, FGH415, FGH417, FGH507, FGH610, FGH613, FGH615, FGH617, LGB430, LGF124, LGF224, LGG420, NGF144, NGF224, NGH507, NGH727, NGW250, NGW450, PGH218, PGH418, PGH618





accessories for	101284			
	Part No.	101259	Ref. No.	—
	union nut thread M8x1 for pipe ø 4mm			

Table continues overleaf





accessories for	101284		
	Part No.	101285	Ref. No. —
	union screw thread M8x1 for pipe ø 4mm Qty 1 pcs JUNKERS		
	Part No.	101294	Ref. No. —
	union nut thread M10x1 for pipe ø 4mm WS 14 L 12mm Qty 1 pcs		

union screws			
	1		
Part No.	100904	Ref. No.	178462
description	locking screw M10x1 for pipe ø 4mm Qty 1 pcs		

gas lines			
main gas lines			
universal			
	1		
Part No.	109179	Ref. No.	151432
description	gas line connection ø4mm L 320mm ED ø 12mm SS flexible thickness 0.75mm connection length 20mm		
For models:	EGB230, EGB430, EGH210, EGH410, EGH413, EGH417, EGH610, EGH613, EGH617, FGH210, FGH410, FGH413, FGH415, FGH417, FGH610, FGH613, FGH615, FGH617, PGB438, PGH218, PGH418, PGH618		

	1		
Part No.	109178	Ref. No.	151425
description	gas line connection ø4mm L 680mm ED ø 12mm SS flexible thickness 0.75mm connection length 30mm		
For models:	EGF124, EGF224, EGH210, EGH410, EGH413, EGH417, EGH610, EGH613, EGH617, FGH210, FGH410, FGH413, FGH415, FGH417, FGH610, FGH613, FGH615, FGH617, FGW250, PGH218, PGH418, PGH618		

equipment-specific units			
for deep fryers			
glass panels			
	1		
Part No.	691322	Ref. No.	148990 504872 537365
description	glass panel ø 40mm thickness 4mm		
For models:	CBG110, CBG120, CGD110, CGD120, EGB230, EGB430, EGF124, EGF224, EGP500, FGH500, FGH507, FGW250, LGB430, LGF124, LGF224, LGG420, LGP400, NGB430, NGF144, NGF224, NGG420, NGH500, NGH503, NGH505, NGH507, NGH720, NGH723, NGH725, NGH727, NGH730, NGH733, NGH737, NGP400, NGP600, NGP900, NGW250, NGW450, PGB438, PGF148, PGF228, PGH508, PGW458		

for tilting bratt pans			
glass panels			
	1		
Part No.	691322	Ref. No.	148990 504872 537365
description	glass panel ø 40mm thickness 4mm		
For models:	CBG110, CBG120, CGD110, CGD120, EGB230, EGB430, EGF124, EGF224, EGP500, FGH500, FGH507, FGW250, LGB430, LGF124, LGF224, LGG420, LGP400, NGB430, NGF144, NGF224, NGG420, NGH500, NGH503, NGH505, NGH507, NGH720, NGH723, NGH725, NGH727, NGH730, NGH733, NGH737, NGP400, NGP600, NGP900, NGW250, NGW450, PGB438, PGF148, PGF228, PGH508, PGW458		

miscellaneous			
	1		
Part No.	691321	Ref. No.	504871 537366 706610000
description	frame		
For models:	CBG110, CBG120, CGD110, CGD120, EGB230, EGB430, EGF124, EGF224, EGP500, FGH500, FGH507, FGW250, LGB430, LGF124, LGF224, LGG420, LGP400, NGB430, NGF144, NGF224, NGG420, NGH500, NGH503, NGH505, NGH507, NGH720, NGH723, NGH725, NGH727, NGH730, NGH733, NGH737, NGP400, NGP600, NGP900, NGW250, NGW450, PGB438, PGF148, PGF228, PGH508, PGW458		

for boiling pans			
spare parts and accessories			
	1		
Part No.	693498	Ref. No.	146894
description	bush for plunger		
For models:	CBG110, CBG120, CGD110, CGD120, NGR150, NGR250, NGR300, NGR400, NGS040, NGS060, NGS080, NGS100, NGS150		

	1		
Part No.	693499	Ref. No.	146893
description	plunger		
For models:	CBG110, CBG120, CGD110, CGD120, NGR150, NGR250, NGR300, NGR400, NGS040, NGS060, NGS080, NGS100, NGS150		



filters



1

Part No.	691323	Ref. No.	130800 852140002 942063002
description	drain filter kettle size 94x55mm		
For models:	EES060, EES080, EGS060, FEK040, FEK060, FEK080, FEK100, FEK150, FES040, FES060, FES080, FES100, FES150, FGS040, FGS060, FGS080, FGS100, FGS150, FNK040, FNK060, FNK080, FNK100, FNK150, FNS040, FNS060, FNS080, FNS100, FNS150, LES060, LGS060, NES040, NES060, NES080, NES100, NES150, NGS040, NGS060, NGS080, NGS100, NGS150, NHS040, NHS060, NHS080, NHS100, NHS150, NNS040, NNS060, NNS080, NNS100, NNS150...(Other models you can see in the webshop)		

gearboxes



1

Part No.	520402	Ref. No.	115914 780709004
description	auger gear		
For models:	NEK040, NEK060, NEK080, NEK100, NEK150, NNK040, NNK060, NNK080, NNK100, NNK150		

glass panels



1

Part No.	691322	Ref. No.	148990 504872 537365
description	glass panel ø 40mm thickness 4mm		
For models:	CBG110, CBG120, CGD110, CGD120, EGB230, EGB430, EGF124, EGF224, EGP500, FGH500, FGH507, FGW250, LGB430, LGF124, LGF224, LGG420, LGP400, NGB430, NGF144, NGF224, NNG420, NGH500, NGH503, NGH505, NGH507, NGH720, NGH723, NGH725, NGH727, NGH730, NGH733, NGH737, NPG400, NPG600, NPG900, NGW250, NGW450, PGB438, PGF148, PGF228, PGH508, PGW458		

for ovens

miscellaneous



1

Part No.	691321	Ref. No.	504871 537366 706610000
description	frame		
For models:	CBG110, CBG120, CGD110, CGD120, EGB230, EGB430, EGF124, EGF224, EGP500, FGH500, FGH507, FGW250, LGB430, LGF124, LGF224, LGG420, LGP400, NGB430, NGF144, NGF224, NNG420, NGH500, NGH503, NGH505, NGH507, NGH720, NGH723, NGH725, NGH727, NGH730, NGH733, NGH737, NPG400, NPG600, NPG900, NGW250, NGW450, PGB438, PGF148, PGF228, PGH508, PGW458		

for dishwashers

drain and intake components

miscellaneous

overflow pipes



1

Part No.	691324	Ref. No.	061427 540244
description	overflow pipe L 90mm ø 40mm		
For models:	EEB230, EEB430, EGB230, EGB430		

washing and rinsing systems



1

Part No.	510643	Ref. No.	408860
description	rinse jet		
For models:	KGD131, KGE052, KGE066, KGE081, KGE131		



1

Part No.	521019	Ref. No.	408839
description	union nut wash jet		
For models:	KGD131, KGE052, KGE066, KGE081, KGE131		



knobs

producer-specific knobs

KÜPPERSBUSCH



1	Part No.	110189	Ref. No.	189005 189009
	description	knob without symbol ø 62mm shaft ø 6x4.6mm shaft flat upper black		
	For models:	CBE106, CBE106-VAR091, CBE110, CBE110-VAR091, CBE120, CBE120-VAR091, CBE220, CBE220-VAR091, CBG110, CBG120, CEC106, CEC110, CEC120, CEC220, CED106, CED110, CED120, CED220, CGD110, CGD120, EAB051, ECD106, ECD110, ECD120, ECD220, ECL484, EDC106, EEB230, EEB430, EEF040, EEF124, EEF224, EEH210, EEH300, EEH410, EEH413, EEH500, EEH503, EEH610, EEH613, EEH700, EEH703, EEP500, EES060, EES080, EEW250, EEW400, EEW450, EEW452, EGB230...(Other models you can see in the webshop)		
	spare parts for	110189		
		Part No.	111776	Ref. No. —
	knob spring L 13.2mm W 7.4mm thickness 0.4mm Qty 10 pcs			

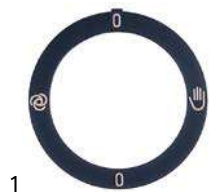

1	Part No.	111567	Ref. No.	100302
	description	knob dial plate black manual/automatic t.max.°C		
	For models:	NEP601, NEP901, NER080, NER150, NER250, NER300, NER400, NES040, NES060, NES080, NES100, NES150, NGR150, NGR250, NGR300, NGR400, NGS040, NGS060, NGS080, NGS100, NGS150, NNR080, NNR150, NNR250, NNR300, NNR400, NNS040, NNS060, NNS080, NNS100, NNS150		



1	Part No.	111555	Ref. No.	144769
	description	knob dial plate energy regulator 1-3 2-circuit		



1	Part No.	111712	Ref. No.	141096
	description	knob dial plate gas tap with ignition flame		
	For models:	EGS060, GHO101, NGH500, NGH503, NGH505, NGH507, NGH720, NGH723, NGH725, NGH727, NGH730, NGH733, NGH737, PGH508		



1	Part No.	111956	Ref. No.	100329
	description	knob dial plate gas tap with ignition flame		
	For models:	EGH210, EGH410, EGH413, EGH417, EGH610, EGH613, EGH617, FGH210, FGH410, FGH413, FGH415, FGH417, FGH500, FGH507, FGH610, FGH613, FGH615, FGH617, PGH218, PGH418, PGH508, PGH618		



1	Part No.	111713	Ref. No.	141124
	description	knob dial plate gas thermostat 1-8 EGA		
	For models:	NGF144		



1	Part No.	110538	Ref. No.	141111
	description	knob dial plate red gas tap with ignition flame EGA24197 t.max.°C ED ø 59mm ID ø 45.5mm		
	For models:	LGP400, LGS060, NGP400, NGP600, NGP900, NGS040, NGS060, NGS080, NGS100, NGS150		

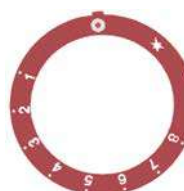

1	Part No.	110547	Ref. No.	141110
	description	knob dial plate red gas thermostat EGA 1-8 t.max.°C ED ø 59mm ID ø 45.5mm		
	For models:	EGH417, EGH617, LGH407, LGH607, NGH407, NGH417, NGH507, NGH607, NGH617, NGH727, NGH737		



1	Part No.	111568	Ref. No.	141098
	description	knob dial plate red gas thermostat ROBERTSHAW t.max.°C ED ø 59mm ID ø 45.5mm		
	For models:	NGR150, NGR250, NGR300, NGR400		

mechanical components,
equipment accessories

1

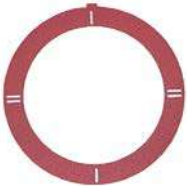
1

Part No.	110548	Ref. No.	141108
description	knob dial plate red switch 1-2-1-2 t.max. °C ED ø 59mm ID ø 45.5mm		
For models:	FEH415, FEH505, FEH515, FEH615, FEH705, FEH715, FGH415, FGH615, LEH405, LEH505, LEH605, LEH705, LGH405, LGH605, NEH415, NEH505, NEH615, NEH705, NGH405, NGH415, NGH505, NGH605, NGH615, NGH725		

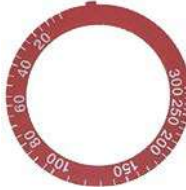

1

Part No.	110532	Ref. No.	144767
description	knob dial plate red thermostat t.max. 300°C 0-300°C rotation 270° ED ø 59mm ID ø 45.5mm		
For models:	CED106, CED110, CED120, CED220		



1

Part No.	110533	Ref. No.	144766
description	knob dial plate red thermostat t.max. 100°C 0-100°C rotation 270° ED ø 59mm ID ø 45.5mm		
For models:	CED106, CED110, CED120, CED220		



1

Part No.	110549	Ref. No.	141106
description	knob dial plate red thermostat t.max. 300°C 50-300°C rotation 270° ED ø 59mm ID ø 45.5mm		
For models:	EEH413, EEH503, EEH613, EEH703, EGH413, EGH613, FEH413, FEH415, FEH503, FEH505, FEH513, FEH515, FEH613, FEH615, FEH705, FEH715, FGH413, FGH415, FGH613, FGH615, LEH405, LEH503, LEH505, LEH605, LEH703, LEH705, LGH405, LGH605, NEH413, NEH415, NEH505, NEH613, NEH615, NEH705, NGH403, NGH405, NGH413, NGH415, NGH503, NGH505, NGH603, NGH605, NGH613, NGH615, NGH723, NGH725, NGH730, NGH733		



1

Part No.	110546	Ref. No.	141109
description	knob dial plate red thermostat t.max. 110°C 30-110°C rotation 270° ED ø 59mm ID ø 45.5mm		
For models:	FEH613, FEH615, FEH705, FEH715, FEW252, FGH613, FGH615, LEH605, LEH703, LEH705, LEW452, LGH605, LGH607, NEA182, NEH212, NEH613, NEH615, NEH705, NEW182, NEW252, NEW452, NGH202, NGH603, NGH605, NGH607, NGH613, NGH615, NGH617, NGH723, NGH725, NGH727, NGH733, NGH737		



1

Part No.	110544	Ref. No.	144750
description	knob dial plate silver 0-FRITTIEREN-0-SCHMELZEN t.max. °C ED ø 59mm ID ø 45.5mm		
For models:	LEF124, LEF224, NEF124, NEF144, NEF224, NEF244, SEF124, SEF144, SEF224		



1

Part No.	110535	Ref. No.	141080
description	knob dial plate red thermostat t.max. 250°C 50-250°C rotation 270° ED ø 59mm ID ø 45.5mm		
For models:	CEC106, CEC110, CEC120, CEC220, EAB051, EDC106		



1

Part No.	111560	Ref. No.	144769
description	knob dial plate silver energy regulator 1-3 2-circuit t.max. °C ED ø 59mm ID ø 45.5mm		
For models:	LEH500, LEH503, LEH505, LEH700, LEH703, LEH705, SEH300, TEH300		

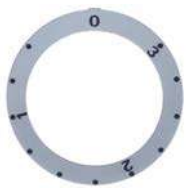
1

Part No.	110551	Ref. No.	141078 141178
description	knob dial plate silver energy regulator 1-3 t.max.°C°C turn direction clockwise ED ø 59mm ID ø 45.5mm		
For models:	EEF040, EEH210, EEH300, EEH410, EEH413, EEH500, EEH503, EEH610, EEH613, EEH700, EEH703, EES060, EES080, FEF040, FEH500, FEH503, FEH505, FEH510, FEH513, FEH515, FEH700, FEH705, FEH710, FEH715, LEB231, LEB431, LEB631, LEF040, LEH500, LEH503, LEH505, LEH700, LEH703, LEH705, NEB431, NEB631, NEB831, NEF040, NEH500, NEH505, NEH700, NEH705, NEK040, NEK060, NEK080, NEK100, NEK150, NES040, NES060, NES080...(Other models you can see in the webshop)		



1

Part No.	110543	Ref. No.	141099
description	knob dial plate silver gas thermostat EGA 1-8 t.max.°C°C ED ø 59mm ID ø 45.5mm		
For models:	EGB230, EGB430, EGF124, EGF224, LGF124, LGF224, NGF224		



1

Part No.	110558	Ref. No.	141096
description	knob dial plate silver gas tap PEL21/22/23 t.max.°C°C ED ø 59mm ID ø 45.5mm PEL		

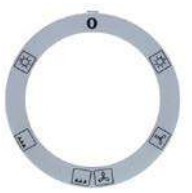

1

Part No.	111946	Ref. No.	144744 144749
description	knob dial plate silver oven t.max.°C°C ED ø 59mm ID ø 45.5mm		
For models:	ECL484		



1

Part No.	110550	Ref. No.	141104
description	knob dial plate silver gas tap with ignition flame EGA26440 t.max.°C°C ED ø 59mm ID ø 45.5mm		
For models:	EGH210, EGH410, EGH413, EGH417, EGH610, EGH613, EGH617, LGB430, LGG420, NGB430, NGG420, NGH200, NGH202, NGH210, NGH400, NGH403, NGH405, NGH407, NGH410, NGH413, NGH415, NGH417, NGH600, NGH603, NGH605, NGH607, NGH610, NGH613, NGH615, NGH617, NGH720, NGH723, NGH725, NGH727, NGH737, PGH218, PGH418, PGH618		



1

Part No.	110542	Ref. No.	144734
description	knob dial plate silver switch 0-1-0-1 t.max.°C°C ED ø 59mm ID ø 45.5mm		



1

Part No.	110541	Ref. No.	141094
description	knob dial plate silver gas tap without ignition flame EGA26400 t.max.°C°C ED ø 59mm ID ø 45.5mm		
For models:	LGH405, LGH407, LGH605, LGH607		



1

Part No.	111569	Ref. No.	144734
description	knob dial plate silver switch 1-0-1 t.max.°C°C ED ø 59mm ID ø 45.5mm		
For models:	NDD080, NDD150, NDD250, NDD300, NED080, NED150, NED250, NED300, NEM100, NER080, NER150, NER250, NER300, NER400, NER500, NES040, NES060, NES080, NES100, NES150, NGR150, NGR250, NGR300, NGR400, NHD080, NHD150, NHD250, NHD300, NHR080, NHR150, NHR250, NHR300, NHR400, NHR500, NHS040, NHS060, NHS080, NHS100, NHS150, WES0400, WES0600, WES0800, WES1000, WES1500		

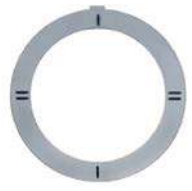

1

Part No.	111711	Ref. No.	141079
description	knob dial plate silver switch 1-2-1-2 t.max.°C°C ED ø 59mm ID ø 45.5mm		
For models:	FEF124, FEF144, FEF224, PEF128, PEF148, PEF228		

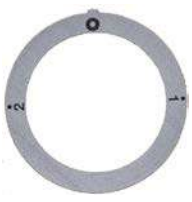
Part No.	110539	Ref. No.	141082
description	knob dial plate silver switch 2-0-1 t.max.°C 1-2°C ED ø 59mm ID ø 45.5mm		
For models:	EES060, EES080, LES060, NDD080, NDD150, NDD250, NDD300, NED080, NED150, NED250, NED300, NEK040, NEK060, NEK080, NEK100, NEK150, NER080, NER150, NER250, NER300, NER400, NER500, NES040, NES060, NES080, NES100, NES150, NHD080, NHD150, NHD250, NHD300, WES0400, WES0600, WES0800, WES1000, WES1500		



Part No.	110537	Ref. No.	141093
description	knob dial plate silver switch zero mark t.max.°C ED ø 59mm ID ø 45.5mm		
For models:	EDC106, LES060, LGS060, NGS040, NGS060, NGS080, NGS100, NGS150, NGW250, NGW450		



Part No.	111566	Ref. No.	100317
description	knob dial plate silver switch 2-0-1 t.max.°C ED ø 59mm ID ø 45.5mm		
For models:	EEW400		



Part No.	110540	Ref. No.	141087
description	knob dial plate silver thermostat 1-10 t.max.°C 1-10°C rotation 270° ED ø 59mm ID ø 45.5mm		
For models:	LEB270, LES060, NEM100, NER080, NER150, NER250, NER300, NER400, NER500, NES040, NES060, NES080, NES100, NES150, NGR150, NGR250, NGR300, NGR400, NHR080, NHR150, NHR250, NHR300, NHR400, NHR500, NHS040, NHS060, NHS080, NHS100, NHS150, NNR080, NNR150, NNR250, NNR300, NNR400, NNR500, NNS040, NNS060, NNS080, NNS100, NNS150, SES400, WES0400, WES0600, WES0800, WES1000, WES1500		



Part No.	110553	Ref. No.	141070
description	knob dial plate silver switch 4-position t.max.°C ED ø 59mm ID ø 45.5mm		
For models:	FEH210, FEH410, FEH413, FEH415, FEH610, FEH613, FEH615, NEH210, NEH212, NEH410, NEH413, NEH415, NEH610, NEH613, NEH615, NEP060, PEH218, PEH418, PEH618		

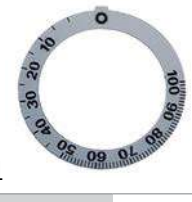

Part No.	110556	Ref. No.	100305
description	knob dial plate silver thermostat t.max. 100°C 0-100°C rotation 270° ED ø 59mm ID ø 45.5mm		
For models:	CBE106, CBE106-VAR091, CBE110, CBE110-VAR091, CBE120, CBE120-VAR091, CBE220, CBE220-VAR091, CBG110, CBG120, CEC106, CEC110, CEC120, CEC220, CED106, CED110, CED120, CED220, CGD110, CGD120		



Part No.	110552	Ref. No.	141061 141069
description	knob dial plate silver switch 7-position t.max.°C ED ø 59mm ID ø 45.5mm		
For models:	EHO101, EHO111, FEH210, FEH410, FEH413, FEH415, FEH610, FEH613, FEH615, LEH405, LEH605, NEH210, NEH212, NEH410, NEH413, NEH415, NEH610, NEH613, NEH615, PEH218, PEH418, PEH618, SEH200		



Part No.	111562	Ref. No.	100315
description	knob dial plate silver thermostat t.max. 110°C 30-110°C rotation 270° ED ø 59mm ID ø 45.5mm		
For models:	EEW250, EEW450, EEW452		

1

Part No.	110545	Ref. No.	141091
description	knob dial plate silver thermostat t.max. 110°C 30-110°C rotation 310° ED ø 59mm ID ø 45.5mm		
For models:	FEW250, FEW252, LEW450, LEW452, NEA182, NEW180, NEW182, NEW250, NEW252, NEW450, NEW452, PEW458, PEW658, SEW250, SEW400, SEW450, TEW250, TEW400, TEW450		



1

Part No.	111565	Ref. No.	100320
description	knob dial plate silver thermostat t.max. 110°C 60-110°C rotation 180° ED ø 59mm ID ø 45.5mm		
For models:	EEW400		



1

Part No.	111564	Ref. No.	100319
description	knob dial plate silver thermostat t.max. 185°C 100-185°C rotation 270° ED ø 59mm ID ø 45.5mm		
For models:	EEF124, EEF224		



1

Part No.	110536	Ref. No.	141092
description	knob dial plate silver thermostat t.max. 195°C 100-195°C rotation 270° ED ø 59mm ID ø 45.5mm		
For models:	LEF124, LEF224, NEF124, NEF144, NEF176, NEF224, NEF244, SEF124, SEF144, SEF224, TEF124, TEF144, TEF224		



1

Part No.	111563	Ref. No.	100312
description	knob dial plate silver thermostat t.max. 195°C 100-195°C rotation 270° ED ø 59mm ID ø 45.5mm		
For models:	FEF124, FEF144, FEF224, PEF128, PEF148, PEF228		

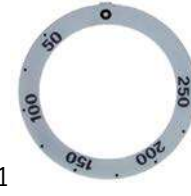

1

Part No.	111947	Ref. No.	141088
description	knob dial plate silver thermostat t.max. 250°C 50-250°C rotation 270° ED ø 59mm ID ø 45.5mm		
For models:	ECL484		



1

Part No.	110557	Ref. No.	100309
description	knob dial plate silver thermostat t.max. 270°C 0-270°C rotation 250° ED ø 59mm ID ø 45.5mm		
For models:	CBE106, CBE106-VAR091, CBE110, CBE110-VAR091, CBE120, CBE120-VAR091, CBE220, CBE220-VAR091, CBG110, CBG120, CEC106, CEC110, CEC120, CEC220, CGD110, CGD120		



1

Part No.	110554	Ref. No.	100307
description	knob dial plate silver thermostat t.max. 300°C 0-300°C rotation 270° ED ø 59mm ID ø 45.5mm		
For models:	CED106, CED110, CED120, CED220		



1

Part No.	110530	Ref. No.	141077 144707
description	knob dial plate silver thermostat t.max. 300°C 60-300°C rotation 270° ED ø 59mm ID ø 45.5mm		
For models:	ECD106, ECD110, ECD120, ECD220, EEB230, EEB430, EEP500, EGP500, FEB430, FEB630, FEP600, FEP900, LEB430, LEG420, LEP400, NEB430, NEB630, NEG420, NEP060, NEP203, NEP303, NEP400, NEP600, NEP900, PEB438, PEB638, PEP608, PEP908, PGP608, PGP908, SEB230, SEB430, SEB630, SEG220, SEG420, SEG620		



			
1			
Part No.	110531	Ref. No.	144706
description	knob dial plate silver time 120min + permanent ON t.max.°C°C ED ø 59mm ID ø 45.5mm		
For models:	ECD106, ECD110, ECD120, ECD220, ECL484		

			
1			
Part No.	110534	Ref. No.	144770
description	knob dial plate silver time 120min + permanent ON t.max.°C°C ED ø 59mm ID ø 45.5mm		
For models:	CEC106, CEC110, CEC120, CEC220, CED106, CED110, CED120, CED220		

			
1			
Part No.	110555	Ref. No.	100306
description	knob dial plate silver time 120min + permanent ON t.max.°C°C ED ø 59mm ID ø 45.5mm		
For models:	CBE106, CBE106-VAR091, CBE110, CBE110-VAR091, CBE120, CBE120-VAR091, CBE220, CBE220-VAR091, CBG110, CBG120, CEC106, CEC110, CEC120, CEC220, CED106, CED110, CED120, CED220, CGD110, CGD120		

accessories

gaskets

			
1			
Part No.	550886	Ref. No.	060306
description	gasket for shaft shaft ø 6x4.6mm ED ø 18mm rubber		
For models:	CBE106, CBE106-VAR091, CBE110, CBE110-VAR091, CBE120, CBE120-VAR091, CBE220, CBE220-VAR091, CBG110, CBG120, CEC106, CEC110, CEC120, CEC220, CED106, CED110, CED120, CED220, CGD110, CGD120, EEB230, EEB430, EEH210, EEH300, EEH410, EEH413, EEH500, EEH503, EEH610, EEH613, EEH700, EEH703, EEP500, EES060, EES080, EGH413, EGH613, EGP500, EGS060, FEB430, FEB630, FEF040, FEF124, FEF144, FEF224, FEH210, FEH410, FEH413, FEH415, FEH500...(Other models you can see in the webshop)		

knob screws

			
1			
Part No.	110066	Ref. No.	133364
description	knob screw		

handles and hand wheels

hand wheels

			
1			
Part No.	690860	Ref. No.	061424 062394 062395 358534 846881004
description	hand wheel ø 160mm D1 ø 40mm bore ø 16mm thread M5 hole distance 8mm groove width L1 22mm L2 50mm handle length 75mm with folding handle		
For models:	LEP400, LGP400, NEK040, NEK060, NEK080, NEK100, NEK150, NNK040, NNK060, NNK080, NNK100, NNK150		

			
1			
Part No.	690800	Ref. No.	540479
description	hand wheel ø 160mm D1 ø 45mm bore ø 16mm depth of bore 32mm thread groove width 5mm L1 25mm L2 60mm handle length 82mm with folding handle		
spare parts for	690800		
	Part No.	514428	Ref. No. —
	folding handle ø 25mm total length 115mm seat ø 26mm thread M8 with automatic return		



1

Part No.	690901	Ref. No.	540479
description	hand wheel \varnothing 160mm D1 \varnothing 45mm bore \varnothing 16mm thread groove width 5mm L1 27mm L2 60mm handle length 85mm with folding handle		
spare parts for	690901		
	Part No.	514428	Ref. No. —
	folding handle \varnothing 25mm total length 115mm seat \varnothing 26mm thread M8 with automatic return		



1

Part No.	690553	Ref. No.	061425 062395
description	hand wheel \varnothing 200mm D1 \varnothing 50mm bore \varnothing 16mm thread M6 hole distance 15mm groove widthmm L1 34mm L2 142mm handle length 85mm with folding handle		
For models:	NEP400, NEP600, NEP900, NGP400, NGP600, NGP900		
spare parts for	690553		
	Part No.	514255	Ref. No. —
	folding handle \varnothing 26mm total length 85mm seat \varnothing 20mm shaft \varnothing mm thread M6 with pin L 85mm		

spare parts and accessories



1

Part No.	540246	Ref. No.	407033
description	cylindrical handle thread M8 \varnothing 23mm L 65mm rotary		
For models:	NEK040, NEK060, NEK080, NEK100, NEK150, NNK040, NNK060, NNK080, NNK100, NNK150		

cylindrical handles

rotary



1

Part No.	540246	Ref. No.	407033
description	cylindrical handle thread M8 \varnothing 23mm L 65mm rotary		
For models:	NEK040, NEK060, NEK080, NEK100, NEK150, NNK040, NNK060, NNK080, NNK100, NNK150		

ball handles



1

Part No.	540323	Ref. No.	356406
description	ball handle thread M10 \varnothing 40mm with metal bush black		
For models:	EAB081, EAB101, EAB102, EAB112, EEP500, EES060, EES080, EGP500, EGS060, FED080, FED150, FED250, FED300, FEK040, FEK060, FEK080, FEK100, FEK150, FEP230, FEP330, FES040, FES060, FES080, FES100, FES150, FGS040, FGS060, FGS080, FGS100, FGS150, FNK040, FNK060, FNK080, FNK100, FNK150, FNS040, FNS060, FNS080, FNS100, FNS150, LES060, LGS060, NDD080, NDD150, NDD250, NDD300, NED080, NED150, NED250, NED300...(Other models you can see in the web-shop)		

accessories

marking caps



1

Part No.	514358	Ref. No.	151904
description	marking cap blue hood handle		



1

Part No.	514359	Ref. No.	151903
description	marking cap red hood handle		

locks



turning lever locks

universal

RAHRBACH



1

Part No.	700098	Ref. No.	407376
description	door catch mounting pos. right off-set 38mm L 110mm H 74mm W 33mm mounting distance 68/68mm series 1750		
For models:	ECD120, ECD220		
spare parts for	700098		
	Part No.	690136	Ref. No. 407377 707377
	sliding plate mounting pos. right L 28mm H 3mm W 21mm H2 12.5mm		
accessories for	700098		
	Part No.	514281	Ref. No. —
	base plate L 110mm W 35mm for door catch thickness 10mm		





1

Part No.	690136	Ref. No.	407377 707377
description	sliding plate mounting pos. right L 28mm H 3mm W 21mm H2 12.5mm		
For models:	ECD120, ECD220		

STUV



1

Part No.	700098	Ref. No.	407376
description	door catch mounting pos. right off-set 38mm L 110mm H 74mm W 33mm mounting distance 68/68mm series 1750		
For models:	ECD120, ECD220		
spare parts for	700098		
	Part No.	690136	Ref. No. 407377 707377
	sliding plate mounting pos. right L 28mm H 3mm W 21mm H2 12.5mm		
accessories for	700098		
	Part No.	514281	Ref. No. —
	base plate L 110mm W 35mm for door catch thickness 10mm		

edgmount latches



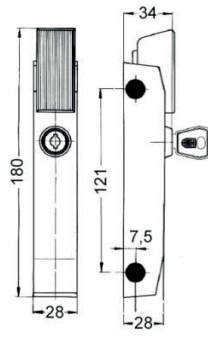

push button latches

RAHRBACH

6186 PRESTO series

1



Part No.	700045	Ref. No.	356468
description	push button latch L 180mm mounting distance 121mm non lockable refrigeration units 6186 H 34mm W 28mm type PRESTO		
For models:	EDC106		
spare parts for	700045		
	Part No.	700046	Ref. No. —
	handle H 26.5mm L 55mm W 23.5mm plastic with spring spring length 14mm mounting thread M4 spring thickness 0.5mm		
accessories for	700045		
	Part No.	690108	Ref. No. —
	base plate H 5mm L 47.5mm W 21mm for swinging strike hole distance 31mm type PRESTO no. 6186		
	Part No.	690109	Ref. No. —
	base plate H 1mm L 47.5mm W 21mm plastic hole distance 31mm type PRESTO no. 6186		
	Part No.	700050	Ref. No. 162357
	door catch H 5mm L 47mm W 21mm hole distance 31mm with spigot refrigeration units type PRESTO no. 6186		
	Part No.	700051	Ref. No. 162357
	door catch H 5mm L 48mm W 21mm adjustable hole distance 31mm with spigot type PRESTO no. 6186		

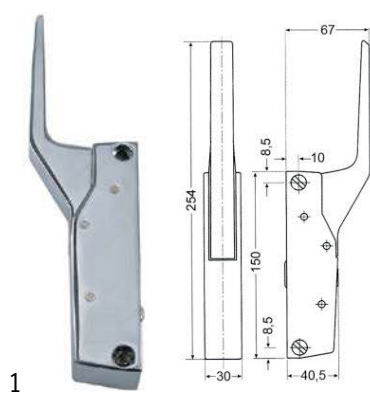

handle latches

CAFF/FERMOD



Part No.	700060	Ref. No.	133199
description	handle latch L 150mm mounting distance 133mm non lockable heated units G 791		
For models:	CBE106, CBE106-VAR091, CBE110, CBE110-VAR091, CBG110, CCE106, CCE110, CEC106, CEC110, CED106, CED110, CEF106, CEF110, CEM110, CGD110, CPE106, CPE110		
accessories for	700060		
	Part No.	700061	Ref. No. 133200
	door catch L 58mm W 20mm H 35mm mounting distance 42mm chrome-plated brass for headed units		
	Part No.	700062	Ref. No. —
	handle protection heated units		

producer-specific

KÜPPERSBUSCH



Part No.	694474	Ref. No.	133030
description	catch L 174mm mounting distance 124/133mm non lockable 6200 black W 32mm total length 250mm		

STUV

3.30.016x.x series

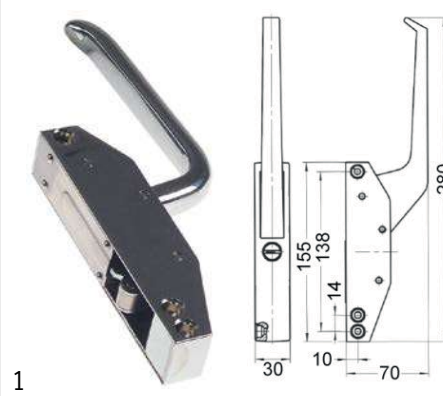

Part No.	693517	Ref. No.	407282
description	catch		

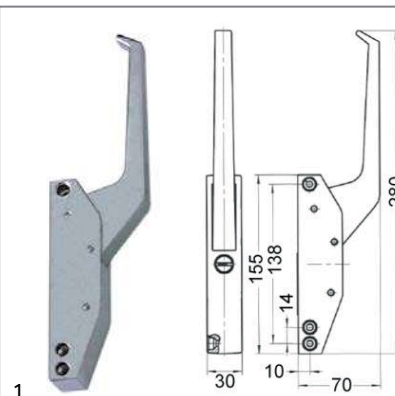



Part No.	700063	Ref. No.	407282
description	handle latch L 155mm mounting distance 124/138mm non lockable refrigeration units 3.30.0164		
For models:	ECD106, ECD110		
accessories for	700063		
	Part No.	700064	Ref. No. 407364
	door catch H 40mm L 28mm W 22mm		



door catches





Part No.	700064	Ref. No.	407364
description	door catch H 40mm L 28mm W 22mm		
For models:	ECD106, ECD110		



			
1			
Part No.	700050	Ref. No.	162357
description	door catch H 5mm L 47mm W 21mm hole distance 31mm with spigot refrigeration units type PRESTO no. 6186		
accessories for	700050		
			
Part No.	690109	Ref. No.	—
description	base plate H 1mm L 47.5mm W 21mm plastic hole distance 31mm type PRESTO no. 6186		

			
1			
Part No.	700051	Ref. No.	162357
description	door catch H 5mm L 48mm W 21mm adjustable hole distance 31mm with spigot type PRESTO no. 6186		
For models:	EAB051		
accessories for	700051		
			
Part No.	690108	Ref. No.	—
description	base plate H 5mm L 47.5mm W 21mm for swinging strike hole distance 31mm type PRESTO no. 6186		

			
1			
Part No.	700061	Ref. No.	133200
description	door catch L 58mm W 20mm H 35mm mounting distance 42mm chrome-plated brass for headed units		
For models:	CBE106, CBE106-VAR091, CBE110, CBE110-VAR091, CBG110, CCE106, CCE110, CEC106, CEC110, CED106, CED110, CEF106, CEF110, CEM110, CGD110, CPE106, CPE110		
accessories for	700061		
			
Part No.	690414	Ref. No.	—
description	handle latch L 150mm mounting distance 133mm non lockable refrigeration units G 791		

			
1			
Part No.	690123	Ref. No.	133032
description	door catch with roller		

walk-in fridge catches

STUV

3.31.015x.x series

			
1			
Part No.	700072	Ref. No.	407380
description	door catch H 17mm L 84mm W 53mm mounting distance 68mm zinc die cast with wedge heated units		
For models:	ECD120, ECD220		

snap locks

producer-specific

KÜPPERSBUSCH

			
1			
Part No.	700072	Ref. No.	407380
description	door catch H 17mm L 84mm W 53mm mounting distance 68mm zinc die cast with wedge heated units		
For models:	ECD120, ECD220		

			
1			
Part No.	690101	Ref. No.	407379
description	snap lock L 85mm W 40mm mounting distance 68mm heated units H 63mm type 1750 series		
For models:	ECD120, ECD220		

espagnolette locks

universal

			
1			
Part No.	690041	Ref. No.	133195
description	cam L 148mm mounting distance 32mm		
For models:	CBE120, CBE120-VAR091, CBE220, CBE220-VAR091, CBG120, CCE120, CCE220, CEC120, CEC220, CED120, CED220, CEF120, CEF220, CEM120, CGD120, CPE120, CPE220		





			
1			
Part No.	690040	Ref. No.	133196
description	door catch with roller H 42mm L 40mm W 40mm zinc die cast mounting distance 26mm type 0751 series		
For models:	CBE120, CBE120-VAR091, CBE220, CBE220-VAR091, CBG120, CCE120, CCE220, CEC120, CEC220, CED120, CED220, CEF120, CEF220, CEM120, CGD120, CPE120, CPE220		

producer-specific

KÜPPERSBUSCH

			
1			
Part No.	693527	Ref. No.	756156000
description	bar for door lock L 441mm ø 10mm		
For models:	CBE120, CBE120-VAR091, CBE220, CBE220-VAR091, CBG120, CCE120, CCE220, CEC120, CEC220, CED120, CED220, CEF120, CEF220, CEM120, CGD120, CPE120, CPE220		





			
1			
Part No.	692173	Ref. No.	817970000
description	base plate H 1mm L 40mm W 40mm SS Qty 1 pcs		

			
1			
Part No.	693530	Ref. No.	817970000
description	base plate L 40mm W 40mm for door catch thickness 1mm Qty 2 pcs		
For models:	CBE120, CBE120-VAR091, CBE220, CBE220-VAR091, CBG120, CCE120, CCE220, CEC120, CEC220, CED120, CED220, CEF120, CEF220, CEM120, CGD120, CPE120, CPE220		

			
1			
Part No.	690041	Ref. No.	133195
description	cam L 148mm mounting distance 32mm		
For models:	CBE120, CBE120-VAR091, CBE220, CBE220-VAR091, CBG120, CCE120, CCE220, CEC120, CEC220, CED120, CED220, CEF120, CEF220, CEM120, CGD120, CPE120, CPE220		

			
1			
Part No.	690040	Ref. No.	133196
description	door catch with roller H 42mm L 40mm W 40mm zinc die cast mounting distance 26mm type 0751 series		
For models:	CBE120, CBE120-VAR091, CBE220, CBE220-VAR091, CBG120, CCE120, CCE220, CEC120, CEC220, CED120, CED220, CEF120, CEF220, CEM120, CGD120, CPE120, CPE220		

			
1			
Part No.	693516	Ref. No.	133193
description	door handle metal		
For models:	CBE120, CBE120-VAR091, CBE220, CBE220-VAR091, CBG120, CCE120, CCE220, CEC120, CEC220, CED120, CED220, CEF120, CEF220, CEM120, CGD120, CPE120, CPE220		

			
1			
Part No.	690042	Ref. No.	133194
description	latch gear opening to the right shaft intake ø 8x8mm L 170mm W 40mm H 40mm		
For models:	CBE120, CBE120-VAR091, CBE220, CBE220-VAR091, CBG120, CCE120, CCE220, CEC120, CEC220, CED120, CED220, CEF120, CEF220, CEM120, CGD120, CPE120, CPE220		
accessories for	690042		
	Part No.	690040	Ref. No. 133196
	door catch with roller H 42mm L 40mm W 40mm zinc die cast mounting distance 26mm type 0751 series		
	Part No.	690041	Ref. No. 133195
	cam L 148mm mounting distance 32mm		
	Part No.	691050	Ref. No. —
	bar ø 10mm for door latch L 113.5mm		

			
1			
Part No.	692013	Ref. No.	156938
description	roll pin ø 3mm L 16mm		
For models:	CBE120, CBE120-VAR091, CBE220, CBE220-VAR091, CBG120, CCE120, CCE220, CEC120, CEC220, CED120, CED220, CEF120, CEF220, CEM120, CGD120, CPE120, CPE220, NGP600, NGP900		



hingess

piano hinges

producer-specific

KÜPPERSBUSCH

Part No.	690004	Ref. No.	407367
description	hinge L 86.5mm W 75mm H 16mm mounting distance 66/55mm mounting distance 1 47/28mm hole \varnothing 5mm thickness 3mm		
For models:	ECD106, ECD110		

oven hinges

Part No.	693045	Ref. No.	131603 131604 131612 131618 133715 133777
description	opposite support L 110mm W 12mm mounting distance 94mm		
For models:	ECL484		

edgemount hinges

RAHRBACH

Part No.	701094	Ref. No.	356467
description	edgemount hinge L 100mm W 19mm mounting distance 60/32.5mm non removable zinc die cast, chrome-plated heated units series 4484 centre of rotation 14/23mm		
For models:	EAB051, EAB081, EAB101, EDC106		

Part No.	690157	Ref. No.	133776
description	oven hinge mounting distance 118mm mounting distance 2mm lug mounting 13mm lever length 114mm groove distance 6mm spring thickness 3.2mm mounting ear position left spring length 56mm L 152mm		
For models:	ECL484		

Part No.	690156	Ref. No.	133775
description	oven hinge mounting distance 118mm mounting distance 2mm lug mounting 13mm lever length 114mm groove distance 6mm spring thickness 3.2mm mounting ear position right spring length 56mm L 152mm		
For models:	ECL484		



door bearing



1

Part No.	693535	Ref. No.	146725 756150000
description	bolt L 19mm mounting pos. upper/lower thread M6 ø 10mm		
For models:	CEC106, CEC110, CED106, CED110		



1

Part No.	693510	Ref. No.	146757 146795 756627000
description	bolt mounting pos. upper/lower for door hinge		
For models:	CBE106, CBE106-VAR091, CBE110, CBE110-VAR091, CBE120, CBE120-VAR091, CBE220, CBE220-VAR091, CBG110, CBG120, CCE106, CCE110, CCE120, CCE220, CEC106, CEC110, CEC120, CEC220, CED106, CED110, CED120, CED220, CEF106, CEF110, CEF120, CEF220, CEM110, CEM120, CGD110, CGD120, CPE106, CPE110, CPE120, CPE220		



1

Part No.	693514	Ref. No.	133545 133548
description	bush for hinge		
For models:	CBE106, CBE106-VAR091, CBE110, CBE110-VAR091, CBE120, CBE120-VAR091, CBE220, CBE220-VAR091, CBG110, CBG120, CCE106, CCE110, CCE120, CCE220, CEC106, CEC110, CEC120, CEC220, CED106, CED110, CED120, CED220, CEF106, CEF110, CEF120, CEF220, CEM110, CEM120, CGD110, CGD120, CPE106, CPE110, CPE120, CPE220		



1

Part No.	693512	Ref. No.	131605
description	hinge mounting pos. lower		
For models:	CBE106, CBE106-VAR091, CBE110, CBE110-VAR091, CBG110, CCE106, CCE110, CEC106, CEC110, CED106, CED110, CEF106, CEF110, CEM110, CGD110, CPE106, CPE110		



1

Part No.	693528	Ref. No.	987474002
description	hinge mounting pos. lower		
For models:	CEC120, CEC220, CED120, CED220		



1

Part No.	693529	Ref. No.	131606
description	hinge mounting pos. lower		
For models:	CBE120, CBE120-VAR091, CBE220, CBE220-VAR091, CBG120, CCE120, CCE220, CEC120, CEC220, CED120, CED220, CEF120, CEF220, CEM120, CGD120, CPE120, CPE220		



1

Part No.	693511	Ref. No.	817658000
description	hinge mounting pos. upper		
For models:	CEC106, CEC110, CED106, CED110		



1

Part No.	693521	Ref. No.	733607000 734382000
description	hinge mounting pos. upper		
For models:	CBE106, CBE106-VAR091, CBE110, CBE110-VAR091, CBE120, CBE120-VAR091, CBE220, CBE220-VAR091, CBG110, CBG120, CCE106, CCE110, CCE120, CCE220, CEC106, CEC110, CEC120, CEC220, CED106, CED110, CED120, CED220, CEF106, CEF110, CEF120, CEF220, CEM110, CEM120, CGD110, CGD120, CPE106, CPE110, CPE120, CPE220		

accessories

miscellaneous



1

Part No.	693513	Ref. No.	134382
description	door bumper		
For models:	CBE106, CBE106-VAR091, CBE110, CBE110-VAR091, CBE120, CBE120-VAR091, CBE220, CBE220-VAR091, CBG110, CBG120, CCE106, CCE110, CCE120, CCE220, CEC106, CEC110, CEC120, CEC220, CED106, CED110, CED120, CED220, CEF106, CEF110, CEF120, CEF220, CEM110, CEM120, CGD110, CGD120, CPE106, CPE110, CPE120, CPE220		



1

Part No.	693515	Ref. No.	131098
description	spring for hinge		
For models:	CEC106, CEC110, CEC120, CEC220, CED106, CED110, CED120, CED220		



pullouts

rollers



rollers



accessories

 <p>1</p>			
Part No.	560133	Ref. No.	154896
description	hexagonal nut thread M6 H 5mm WS 10 SS DIN/ISO DIN 934 / ISO 4032/8673 Qty 20 pcs		
For models:	CEC106, CEC110, CEC120, CEC220, CGD110, CGD120, ECD106, ECD110, ECD120, ECD220, EEF040, EEF124, EEF224, EEW250, EEW400, EEW450, EEW452, FEF180, PEF188		

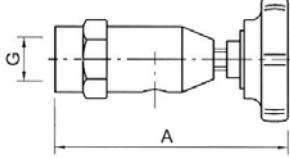
fittings for catering equipment

aerators and air bleeders

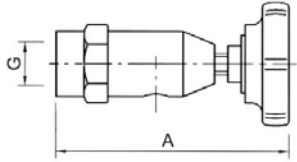
  <p>1</p>			
Part No.	540016	Ref. No.	176017
description	aerator and air bleeder thread 1/2" IT chrome-plated L 78mm		
For models:	NEM100, NES040, NES060, NES080, NES100, NES150, NGR150, NGR250, NGR300, NGR400, NGS040, NGS060, NGS080, NGS100, NGS150, NHS040, NHS060, NHS080, NHS100, NHS150, NNM100, NNS040, NNS060, NNS080, NNS100, NNS150		
spare parts for	540016		
	Part No.	112777	Ref. No. —
	star handle shaft 6x6mm ø 50mm L 18mm black plastic		
	Part No.	540365	Ref. No. —
	star handle shaft 6x6mm ø 50mm L 18mm black thermoplastic		

  <p>1</p>			
Part No.	540013	Ref. No.	176009
description	aerator and air bleeder thread 3/8" ET WS 27 chrome-plated L 86mm		
For models:	LES060, LGS060, NEK040, NEK060, NEK080, NEK100, NEK150, NER080, NER150, NER250, NER300, NER400, NER500, NGS040, NGS060, NGS080, NGS100, NGS150, NHR080, NHR100, NHR150, NHR250, NHR300, NHR400, NHR500, NHS040, NHS060, NHS080, NHS100, NHS150, NNK040, NNK060, NNK080, NNK100, NNK150, NNR080, NNR150, NNR250, NNR300, NNR400, NNR500, NNS040, NNS060, NNS080, NNS100, NNS150, WES0400, WES0600, WES0800, WES1000... (Other models you can see in the webshop)		
spare parts for	540013		
	Part No.	112777	Ref. No. —
	star handle shaft 6x6mm ø 50mm L 18mm black plastic		
	Part No.	540365	Ref. No. —
	star handle shaft 6x6mm ø 50mm L 18mm black thermoplastic		

steam valves

 <p>1</p>			
Part No.	541543	Ref. No.	172655
description	steam valve straight connection 1 1/4" IT total length 110mm H 148mm brass		
For models:	NNR080, NNR150, NNR250, NNR300, NNR400, NNR500		
spare parts for	541543		
	Part No.	540229	Ref. No. —
	star handle shaft 9x9mm ø 80mm L 23mm black thermoplastic		
	Part No.	541546	Ref. No. —
	screw chrome-plated brass thread M5 thread L 10mm		

1 mechanical components, equipment accessories



1

Part No.	541542	Ref. No.	172654
description	steam valve straight connection 1" IT total length 90mm H 140mm brass		
For models:	NNM100, NNS080, NNS100, NNS150		
spare parts for	541542		
	Part No.	540229	Ref. No. —
	star handle shaft 9x9mm ø 80mm L 23mm black thermoplastic		
	Part No.	541546	Ref. No. —
	screw chrome-plated brass thread M5 thread L 10mm		
	Part No.	541548	Ref. No. —
	gasket PTFE ID ø 15mm H 7mm for thread 1¼" ED ø 35mm		
	Part No.	541554	Ref. No. —
	gasket copper ext. ø 49 ID ø 42mm H 2mm for thread 1¼"		
	Part No.	541557	Ref. No. —
	tap head chrome-plated thread 1¼" for steam tap 1"		



1

Part No.	541541	Ref. No.	358137
description	steam valve straight connection 3/4" IT total length 75mm H 118mm brass		
For models:	NNA182, NNK040, NNK060, NNK080, NNK100, NNK150, NNS040, NNS060, NNW180, NNW182		
spare parts for	541541		
	Part No.	541546	Ref. No. —
	screw chrome-plated brass thread M5 thread L 10mm		
	Part No.	541547	Ref. No. —
	gasket PTFE ID ø 9.5mm H 7mm for thread 1" ED ø 27.5mm		
	Part No.	541553	Ref. No. —
	gasket copper ext. ø 39 ID ø 33mm H 2mm for thread 1"		
	Part No.	541556	Ref. No. —
	tap head chrome-plated thread 1" for steam tap 3/4"		
	Part No.	541559	Ref. No. —
	star handle shaft 8x8mm ø 80mm L 23mm black thermoplastic		

lid hinges

type ECHTERMANN

10 series

10.11



1

Part No.	700199	Ref. No.	134360
description	lid hinge type 6910.11 level of centre of rotation 72mm load capacity 50-60NM opening angle 80° closing angle 10° mounting distance 198mm bore ø 11mm chrome-plated		
For models:	NEK040, NEK060, NEK080, NEK100, NEK150, NNK040, NNK060, NNK080, NNK100, NNK150		
spare parts for	700199		
	Part No.	691614	Ref. No. —
	repair kit for lid hinge load capacity 50-60NM		

10.82

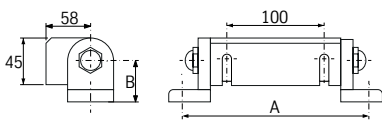
1

Part No.	693214	Ref. No.	134357
description	lid hinge type 1082 level of centre of rotation 45mm load capacity 70-100NM opening angle 80° closing angle 10° mounting distance 220mm bore ø 11mm MD lid 100mm chrome-plated brass L 160mm mounting distance 1 hinge 220mm mounting distance 2 lid 100mm		
For models:	NEP600, NEP900		
spare parts for	693214		
	Part No.	691615	Ref. No. —
	repair kit for lid hinge load capacity 70-100NM		

10.84



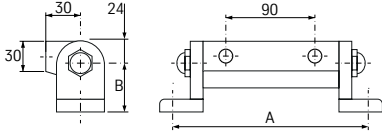

1

Part No.	540876	Ref. No.	131627
description	lid hinge type 1084 level of centre of rotation 45mm load capacity 10-20NM opening angle 75° closing angle 10° mounting distance 198mm bore ø 11mm MD lid 90mm 53.5 MT lid M8mm chrome-plated brass		
For models:	EES060, EES080, EGS060, FES040, FES060, FGS040, FGS060, FNS040, FNS060, PES048, PES068, PGS048, PGS068, PNS048, PNS068		
spare parts for	540876		
	Part No.	691611	Ref. No. —
	repair kit for lid hinge load capacity 10-20NM		



1

Part No.	700196	Ref. No.	134372
description	lid hinge type 1084 level of centre of rotation 45mm load capacity 30-50NM opening angle 75° closing angle 10° mounting distance 198mm bore ø 11mm MD lid 90mm 53.5 MT lid M8mm chrome-plated brass		
For models:	FEK040, FEK060, FEK080, FEK100, FES080, FES100, FGS080, FGS100, FNK040, FNK060, FNK080, FNK100, FNS080, FNS100, NES040, NES060, NES080, NES100, NGS040, NGS060, NGS080, NGS100, NHS040, NHS060, NHS080, NHS100, NNS040, NNS060, NNS080, NNS100, PEK048, PEK068, PEK088, PEK108, PES088, PES108, PGS088, PNK048, PNK068, PNK088, PNK108, PNS088, PNS108		
spare parts for	700196		
	Part No.	560576	Ref. No. —
	grub screw thread M8 L 30mm SS DIN 914 WS 4 Qty 10 pcs		
	Part No.	691613	Ref. No. —
	repair kit for lid hinge load capacity 30-50NM		

1

Part No.	700198	Ref. No.	134373
description	lid hinge type 1084 level of centre of rotation 45mm load capacity 50-60NM opening angle 75° closing angle 10° mounting distance 198mm bore ø 11mm MD lid 90mm 53.5 MT lid M8mm chrome-plated brass		
For models:	FES150, FGS150, FNS150, NES150, NGS150, NHS150, NNS150, PES158, PNS158		
spare parts for	700198		
	Part No.	691614	Ref. No. —
	repair kit for lid hinge load capacity 50-60NM		

10.88

1

Part No.	690848	Ref. No.	154400
description	lid hinge type 1088 level of centre of rotation 45mm bore ø 11mm MD lid 220mm chrome-plated L 160mm mounting distance 1 hinge 220mm mounting distance 2 lid 90mm		
For models:	FEK150, FNK150, PEK158, PNK158		
spare parts for	690848		
	Part No.	691615	Ref. No. —
	repair kit for lid hinge load capacity 70-100NM		

10.89

1

Part No.	693213	Ref. No.	131608
description	lid hinge type 10.89 level of centre of rotation 35mm load capacity 20-30NM opening angle 87° closing angle 10° mounting distance 214mm bore ø 8.5mm MD lid 120mm chrome-plated brass		
For models:	NEP400, NEP600, NEP601, NGP600		
spare parts for	693213		
	Part No.	691612	Ref. No. —
	repair kit for lid hinge load capacity 20-30NM		

1

Part No.	693215	Ref. No.	131609
description	lid hinge type 10.89 level of centre of rotation 35mm load capacity 70-100NM opening angle 87° closing angle 10° mounting distance 214mm bore ø 8.5mm MD lid 120mm chrome-plated brass		
For models:	NEP600, NEP601, NEP900, NEP901, NGP600, NGP900		
spare parts for	693215		
	Part No.	691615	Ref. No. —
	repair kit for lid hinge load capacity 70-100NM		

10.91

1

Part No.	693212	Ref. No.	131624
description	lid hinge type 10.91 level of centre of rotation 75mm load capacity 20-30NM opening angle 87° closing angle 10° mounting distance 175mm MD lid 120mm chrome-plated brass mounting thread M8		
For models:	EEP500, EGP500		
spare parts for	693212		
	Part No.	691612	Ref. No. —
	repair kit for lid hinge load capacity 20-30NM		



10.92

1

Part No.	693211	Ref. No.	131619
description	lid hinge level of centre of rotation 35mm load capacity 70-100NM opening angle 87° closing angle 10° mounting distance 220mm bore ø 11mm MD lid 120mm chrome-plated brass		
For models:	FEP600, FEP610, FEP900, FEP910, PEP608, PEP618, PEP908, PEP918, PGP608, PGP618, PGP908, PGP918		
spare parts for	693211		
	Part No.	691615	Ref. No. —
	repair kit for lid hinge load capacity 70-100NM		

11 series

11.80

1

Part No.	693216	Ref. No.	131930
description	lid hinge		
For models:	FEP230, PEP238		

1

Part No.	693217	Ref. No.	131931
description	lid hinge		
For models:	FEP330, PEP338		

11.81

1

Part No.	690850	Ref. No.	154401
description	lid hinge		
For models:	FED150, PED158		

1

Part No.	690851	Ref. No.	133701 133761
description	lid hinge		
For models:	FED250, PED258		

12 series

12.84

1

Part No.	693447	Ref. No.	144138
description	lid hinge type 1284 level of centre of rotation 50mm load capacity 30-50NM opening angle 80° closing angle 10° mounting distance 198mm bore ø 11mm MD lid 90mm 26.5 MT lid M8mm chrome-plated brass		
spare parts for	693447		
	Part No.	691613	Ref. No. —
	repair kit for lid hinge load capacity 30-50NM		

drain taps

accessories

1

Part No.	540878	Ref. No.	143733
description	adapter drain tap IT 2" ET 1 1/2"		
For models:	FED080, FED150, FED250, FED300, PED088, PED158, PED258, PED308		



steam traps

steam traps

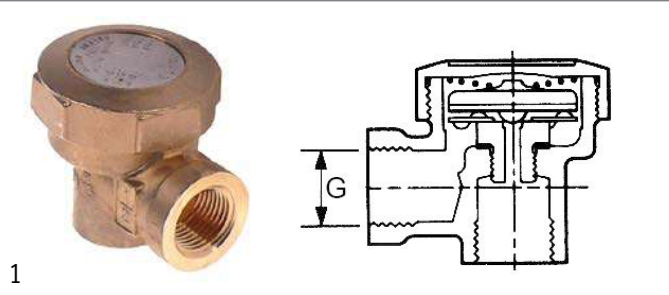

1

Part No.	514272	Ref. No.	150901 540408
description	thermostatic steam trap thread 1/2" type AV13 brass		
For models:	EES060, EES080, EGS060, FED080, FED150, FED250, FED300, FEK040, FEK060, FEK080, FEK100, FEK150, FER080, FER150, FER250, FER300, FER400, FES040, FES060, FES080, FES100, FES150, FGR150, FGR250, FGR300, FGR400, FGS040, FGS060, FGS080, FGS100, FGS150, NER080, NER150, NER250, NER300, NER400, NES040, NES060, NES080, NES100, NES150, NGR150, NGR250, NGR300, NGR400, NGS040, NGS060, NGS080, NGS100, NGS150...(Other models you can see in the web-shop)		

test taps

test taps

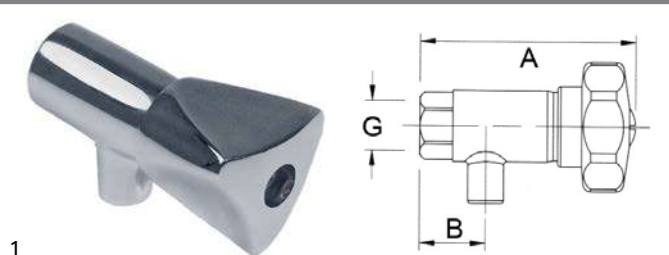

1

Part No.	514277	Ref. No.	170403 170404
description	test tap thread 3/8" IT W 70mm W1 25mm		
For models:	LES060, LGS060, NED080, NED150, NED250, NED300, NEK040, NEK060, NEK080, NEK100, NEK150, NEM100, NER080, NER150, NER250, NER300, NER400, NER500, NES040, NES060, NES080, NES100, NES150, NGR150, NGR250, NGR300, NGR400, NGS040, NGS060, NGS080, NGS100, NGS150, NHD080, NHD150, NHD250, NHD300, NHR080, NHR100, NHR150, NHR250, NHR300, NHR400, NHR500, NHS040, NHS060, NHS080, NHS100, NHS150, WES0400, WES0600... (Other models you can see in the webshop)		

safety fittings

safety fittings



1

Part No.	540882	Ref. No.	151702
description	safety fitting thread 1 1/2" 0.5bar chrome-plated H 185mm ø 100mm		
For models:	FED080, FED150, FED250, FED300, FEP230, FEP330, NEP203, NEP303, PED088, PED158, PED258, PED308, PEP238, PEP338		
spare parts for	540882		
	Part No.	540010	Ref. No. —
	aerator and air bleeder thread 3/8" ET WS 22 chrome-plated metal seated L 22mm		

safety valves

1

Part No.	540883	Ref. No.	172758
description	safety valve		
For models:	NDD080, NDD150, NDD250, NDD300, NED080, NED150, NED250, NED300, NEP203, NEP303, NHD080, NHD150, NHD250, NHD300		



1

Part No.	540880	Ref. No.	172766
description	safety valve 8511EPDMspez		
For models:	NEK040, NEK060, NEK080, NEK100, NEK150		

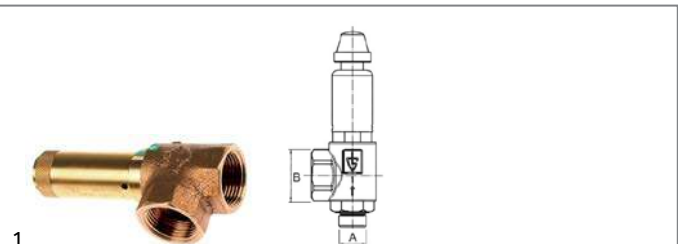

1

Part No.	514354	Ref. No.	540407
description	safety valve T1: 1" T2: 1" triggering pressure 0.5bar		

1 mechanical components, equipment accessories

1

Part No.	514071	Ref. No.	175520 358129
description	safety valve T1: 1" T2: 3/4"		
For models:	FED080, FED150, FED250, FED300, NTE182, PED088, PED158, PED258, PED308		



1

Part No.	514273	Ref. No.	151701
description	safety valve T1: 1/2" T2: 1/2" triggering pressure 0.65bar		
For models:	EES060, EES080, EGS060, FES040, FES060, FES080, FES100, FES150, FGS040, FGS060, FGS080, FGS100, FGS150, NES040, NES060, NES080, NES100, NES150, NGS040, NGS060, NGS080, NGS100, NGS150, PES048, PES068, PES088, PES108, PES158, PGS048, PGS068, PGS088		



1

Part No.	540881	Ref. No.	151704
description	safety valve T1: 3/4" T2: 1" triggering pressure 0.65bar		
For models:	FEK040, FEK060, FEK080, FEK100, FEK150, PEK048, PEK068, PEK088, PEK108, PEK158		

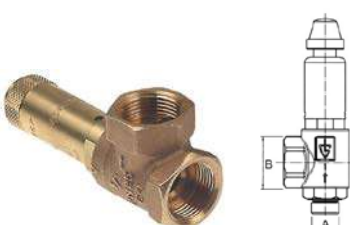

1

Part No.	101977	Ref. No.	151700
description	safety valve T1: 3/4" T2: 3/4" triggering pressure 0.65bar		
For models:	FER080, FER150, FER250, FER300, FER400, FGR150, FGR250, FGR300, FGR400, NER080, NER150, NER250, NER300, NER400, NGR150, NGR250, NGR300, NGR400, PER088, PER158, PER258, PER308		

DERBY RUOTE

spare parts and accessories

miscellaneous



1

Part No.	560192	Ref. No.	407551
description	tooth lock washer ID ø 10.4mm ED ø 18mm SS DIN/ISO DIN 6798A Qty 1 pcs for thread M10		
For models:	ECD106, ECD110, ECD120, ECD220		

WICKE

with bolt hole

sheet steel



1

Part No.	700347	Ref. No.	114428 144428
description	swivel castor with brake ø 125mm bolt hole ø10mm housing zinc-plated sheet steel		



1

Part No.	700346	Ref. No.	114429 144429
description	swivel castor without brake ø 125mm bolt hole ø10mm housing zinc-plated sheet steel		

miscellaneous

with bolt hole

ø125mm

1

Part No.	700348	Ref. No.	144430
description	swivel castor ø 125mm bolt hole ø10mm		
For models:	LEH405, LEH503, LEH505, LEH605, LEH703, LEH705, NEH413, NEH415, NEH505, NEH613, NEH615, NEH705, NGH403, NGH405, NGH503, NGH505, NGH723, NGH725		



1			
Part No.	700349	Ref. No.	144431
description	swivel castor with brake ø 125mm bolt hole ø10mm		

BLICKLE

plastic
ø125mm



1			
Part No.	700913	Ref. No.	114433
description	swivel castor with brake ø 125mm bolt hole 11mm housing plastic bearing slide bearing		



1			
Part No.	700914	Ref. No.	114432
description	swivel castor without brake ø 125mm bolt hole 11mm housing plastic bearing slide bearing		

baskets

warewashing baskets

steel wire baskets square

glass basket



1			
Part No.	970065	Ref. No.	503786
description	glass basket L 400mm W 400mm H 170mm number of rows 4 rows spacing 90mm		

gaskets

refrigeration gaskets

plug-in gaskets

profile 9048

We offer custom-made gaskets for this profile

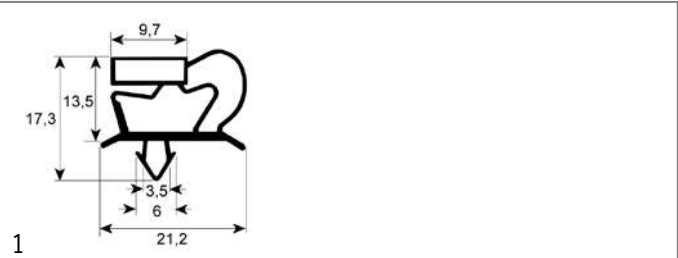

1			
Part No.	900710	Ref. No.	37Q5450
description	refrigeration gasket profile 9048 W 655mm L 1500mm plug size		

gaskets for heated units

window seals

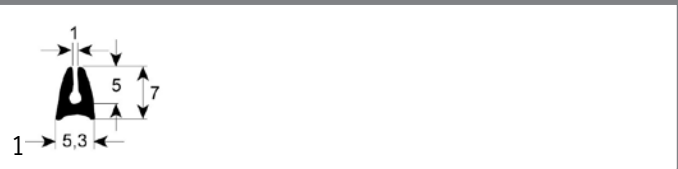

1			
Part No.	900561	Ref. No.	060976 062336
description	window gasket profile 1500 L 1430mm suitable for KÜPPERSBUSCH		
For models:	ECL484		

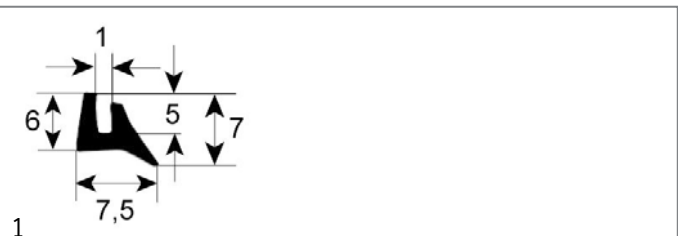

1			
Part No.	900056	Ref. No.	062292 407363
description	window gasket profile 1570 Qty supplied by meter		
For models:	ECD106, ECD110, ECD120, ECD220		

door seals

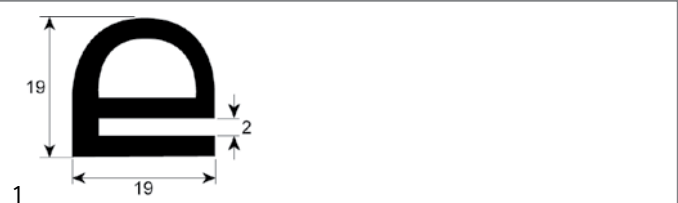

1			
Part No.	900169	Ref. No.	407370
description	door seal profile 2210 L 3800mm Qty 1		
For models:	ECD120		

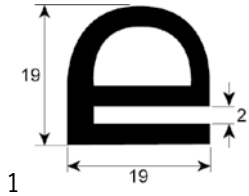

Part No.	900174	Ref. No.	407518
description	door seal profile 2210 L 4200mm Qty 1		
For models:	ECD220		

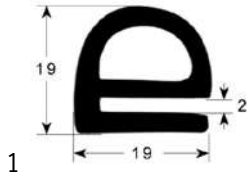

Part No.	900054	Ref. No.	062329 407518
description	door seal profile 2210 Qty supplied by meter		
For models:	CBE106, CBE106-VAR091, CBE110, CBE110-VAR091, CBE120, CBE120-VAR091, CBE220, CBE220-VAR091, CBG110, CBG120, CCE106, CCE110, CCE120, CCE220, CEC106, CEC110, CEC120, CEC220, CED106, CED110, CED120, CED220, CEF106, CEF110, CEF120, CEF220, CEM110, CEM120, CGD110, CGD120, CPE106, CPE110, CPE120, CPE220		

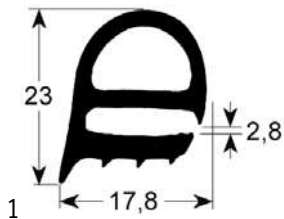

Part No.	902240	Ref. No.	407459
description	door seal profile 2230 W 470mm L 485mm external size Qty 1		
For models:	ECD106		

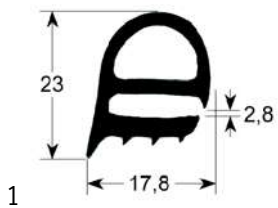

Part No.	900053	Ref. No.	407476
description	door seal profile 2230 W 480mm L 725mm external size Qty 1		
For models:	ECD110		

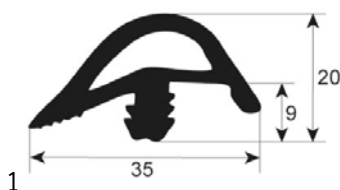

Part No.	900349	Ref. No.	060664
description	door seal profile 2790 W 495mm L 530mm external size Qty 1 insertion size 455x487mm		

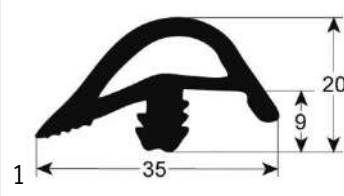

Part No.	900346	Ref. No.	060644 060665
description	door seal profile 2790 W 530mm L 730mm external size Qty 1 insertion size 505x705mm		

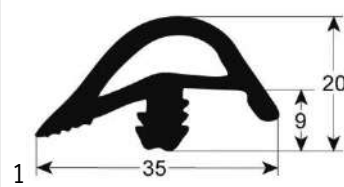

Part No.	901594	Ref. No.	060667
description	door seal profile 2790 W 730mm L 1305mm external size suitable for KÜPPERSBUSCH insertion size 700x1280mm		

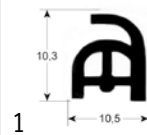

Part No.	900563	Ref. No.	764756007 807969006
description	door seal profile 2935 L 543mm Qty 1 mounting pos. lower		
For models:	EGH417, EGH617, FEH413, FEH415, FEH503, FEH505, FEH513, FEH515, FEH613, FEH615, FEH705, FEH715, FGH413, FGH415, FGH417, FGH507, FGH613, FGH615, FGH617, LGH407, LGH607, NGH407, NGH413, NGH415, NGH417, NGH507, NGH607, NGH613, NGH615, NGH617, NGH727, NGH733, NGH737		

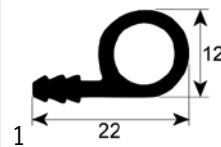

Part No.	901432	Ref. No.	062122 781063
description	door seal profile 2946 Qty supplied by meter		
For models:	EAB051, EDC106		



Part No.	900197	Ref. No.	062371
description	door seal profile 2968 L 345mm Qty 1 mounting pos. upper		
For models:	ECL484		



1

Part No.	900196	Ref. No.	062372
description	door seal profile 2968 L 395mm Qty 1 mounting pos. right/left		
For models:	ECL484		

door seals with fixing hook

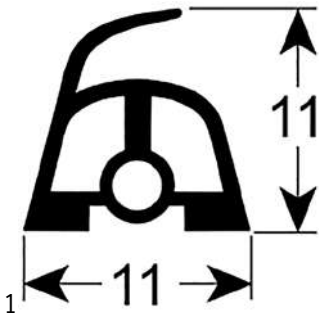

1

Part No.	900390	Ref. No.	807470006
description	door seal L 380mm Wmm with 5 mounting clips		
For models:	EEH413, EEH503, EEH613, EEH703, EGH413, EGH417, EGH613, EGH617, FEH413, FEH415, FEH503, FEH505, FEH513, FEH515, FEH613, FEH615, FEH705, FEH715, FGH413, FGH415, FGH417, FGH507, FGH613, FGH615, FGH617, LEH405, LEH503, LEH505, LEH605, LEH703, LEH705, LGH405, LGH407, LGH605, LGH607, NEH413, NEH415, NEH505, NEH613, NEH615, NEH705, NGH403, NGH405, NGH413, NGH415, NGH417, NGH503, NGH505, NGH507, NGH603...(Other models you can see in the webshop)		

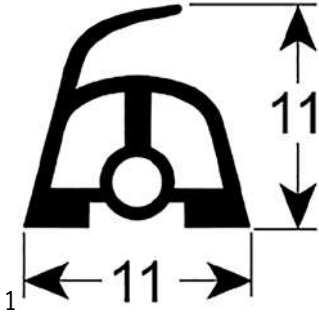

1

Part No.	900391	Ref. No.	807469006
description	door seal L 585mm Wmm with 9 mounting clips		
For models:	EEH413, EEH503, EEH613, EEH703, EGH413, EGH417, EGH613, EGH617, FEH413, FEH415, FEH503, FEH505, FEH513, FEH515, FEH613, FEH615, FEH705, FEH715, FGH413, FGH415, FGH417, FGH507, FGH613, FGH615, FGH617, LEH405, LEH503, LEH505, LEH605, LEH703, LEH705, LGH405, LGH407, LGH605, LGH607, NEH413, NEH415, NEH505, NEH613, NEH615, NEH705, NGH403, NGH405, NGH413, NGH415, NGH417, NGH503, NGH505, NGH507, NGH603...(Other models you can see in the webshop)		

gaskets for tray rack trolleys

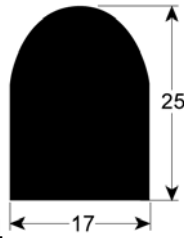

1

Part No.	900055	Ref. No.	062293 062392 407392 407636
description	tray rack trolley gasket profile 4020 Qty supplied by meter silicone foam		
For models:	CBE120, CBE120-VAR091, CBE220, CBE220-VAR091, CBG120, CCE120, CCE220, CEC120, CEC220, CED120, CED220, CEF120, CEF220, CEM120, CGD120, CPE120, CPE220, ECD120, ECD220		

O-rings

EPDM



1

Part No.	532050	Ref. No.	408864
description	O-ring EPDM thickness 2.62mm ID \varnothing 11.91mm Qty 10 pcs		
For models:	KGD040, KGD131, KGE051, KGE052, KGE065, KGE066, KGE081, KGE131, KGH040		



1

Part No.	510408	Ref. No.	060842
description	O-ring EPDM thickness 5.34mm ID \varnothing 47mm Qty 1 pcs		
For models:	CBE120-VAR091, CBE220-VAR091, CCE120, CCE220, CED120, CED220, CEF120, CEF220, CEM120, CPE120, CPE220, FED080, FED150, FED250, FED300, FEK040, FEK060, FEK080, FEK100, FEK150, FER080, FER150, FER250, FER300, FER400, FES040, FES060, FES080, FES100, FES150, NER080, NER150, NER250, NER300, NER400, NES040, NES060, NES080, NES100, NES150, PEK048, PEK068, PEK088, PEK108, PEK158, PER088, PER158, PER258, PER308, PES048...(Other models you can see in the webshop)		

silicone

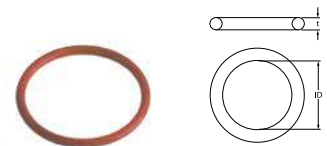

1

Part No.	104264	Ref. No.	060308
description	O-ring silicone thickness 3.53mm ID \varnothing 40.86mm Qty 1 pcs		
For models:	EGB230, EGB430, EGH210, EGH410, EGH413, EGH417, EGH610, EGH613, EGH617, EGP500, FGH210, FGH410, FGH413, FGH415, FGH417, FGH610, FGH613, FGH615, FGH617, NGH210, NGH410, NGH413, NGH415, NGH417, NGH610, NGH613, NGH615, NGH617, NGH730, NGH733, NGH737, PGH218, PGH418, PGH618		

mechanical components, equipment accessories

1



Viton

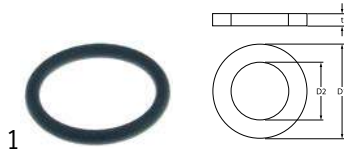

Part No.	550675	Ref. No.	060840
-----------------	--------	-----------------	--------

description O-ring Viton thickness 6mm ID ø 47mm Qty 1 pcs

For models: CBE106, CBE106-VAR091, CBE110, CBE110-VAR091, CBE120, CBE120-VAR091, CBE220, CBE220-VAR091, CBG110, CBG120, CCE106, CCE110, CCE120, CCE220, CEC106, CEC110, CEC120, CEC220, CED106, CED110, CED120, CED220, CEF106, CEF110, CEF120, CEF220, CEM110, CEM120, CGD110, CGD120, CPE106, CPE110, CPE120, CPE220, FEF170, FEF180, KGD020, KGD021, KGD030, KGD040, KGD131, KGE021, KGE051, KGE052, KGE065, KGE066, KGE080, KGE081, KGE131, KGH020...(Other models you can see in the webshop)

sealing washers

copper gaskets

DIN-7603-C



Part No.	510420	Ref. No.	407297
-----------------	--------	-----------------	--------

description gasket copper ED ø 19.9mm ID ø 14.3mm thickness 2mm Qty 1 pcs

For models: ECD106, ECD110, ECD120, ECD220

PTFE gaskets



Part No.	550674	Ref. No.	540537
-----------------	--------	-----------------	--------

description flat gasket PTFE ED ø 46mm ID ø 36mm thickness 4mm Qty 1 pcs mounting pos. inner

For models: EEF124, EEF224, EEW400

silicone gaskets



Part No.	103114	Ref. No.	060436
-----------------	--------	-----------------	--------

description gasket silicone ED ø 34mm ID ø 30mm thickness 2mm Qty 1 pcs

For models: GHP601, LGH405, LGH407, LGH605, LGH607



Part No.	359721	Ref. No.	407286
-----------------	--------	-----------------	--------

description gasket silicone ED ø 48mm ID ø 39.5mm thickness 5mm Qty 1 pcs

For models: ECD106, ECD110, ECD120, ECD220

sealing cords

rectangular



Part No.	692504	Ref. No.	060625
-----------------	--------	-----------------	--------

description sealing cord rectangular size 3.5x4mm supplied by meter

For models: EEH210, EEH410, EEH413, EEH610, EEH613

round



Part No.	510572	Ref. No.	407293
-----------------	--------	-----------------	--------

description sealing cord ø 10mm greased L 0.2m Qty 1

For models: ECD106, ECD110, ECD120, ECD220

special gaskets

miscellaneous



Part No.	550969	Ref. No.	060194 504873
-----------------	--------	-----------------	------------------

description gasket for glass plate for bain marie

For models: CBG110, CBG120, CGD110, CGD120, EGB230, EGB430, EGF124, EGF224, EGP500, FGH500, FGH507, FGW250, LGB430, LGF124, LGF224, LGG420, LGP400, NGB430, NGF144, NGF224, NGG420, NGH500, NGH503, NGH505, NGH507, NGH720, NGH723, NGH725, NGH727, NGH730, NGH733, NGH737, NGP400, NPG600, NPG900, NGW250, NGW450, PGB438, PGF148, PGF228, PGH508, PGW458



Part No.	550891	Ref. No.	062304
-----------------	--------	-----------------	--------

description gasket for lamp L 87mm W 66mm

For models: ECL484



Part No.	510571	Ref. No.	407308
-----------------	--------	-----------------	--------

description gasket suitable for KÜPPERSBUSCH equiv. no. 407308 level regulator

For models: ECD106, ECD110, ECD120, ECD220





thermostat gaskets

			
1			
Part No.	510362	Ref. No.	409190
description	gasket for thermostat ED ø 40mm ID ø 19mm suitable for COMENDA, MEIKO equiv. no. 630511/0108040		
For models:	BSA330, BSA360, KGD312, KGD612, KGE122, KGE340, KGE360, KGE660, KGL260, KGL360, KGU113, KGU122, KGU322, KGU340		

springs

torsion springs

			
1			
Part No.	700197	Ref. No.	131075
description	torsion spring		
For models:	NEP600, NES150, NGP600, NGS150, NHS150, NNS150, WES1500		

			
1			
Part No.	700193	Ref. No.	131075
description	torsion spring ø 27.4mm wire gauge ø 5.7mm L1 20mm L2 160mm L3 16mm		

gas tension springs

gas tension springs

			
1			
Part No.	700513	Ref. No.	540478
description	gas tension spring 700N		

			
1			
Part No.	700515	Ref. No.	541124
description	gas tension spring 900N		

miscellaneous

			
1			
Part No.	700187	Ref. No.	131337 814186000
description	spring for door		
For models:	EEH413, EEH503, EEH613, EEH703, EGH413, EGH417, EGH613, EGH617, FEH413, FEH415, FEH503, FEH505, FEH513, FEH515, FEH613, FEH615, FEH705, FEH715, FGH413, FGH415, FGH417, FGH507, FGH613, FGH615, FGH617, LEH405, LEH503, LEH505, LEH605, LEH703, LEH705, LGH405, LGH407, LGH605, LGH607, NEH413, NEH415, NEH505, NEH613, NEH615, NEH705, NGH403, NGH405, NGH407, NGH413, NGH415, NGH417, NGH503, NGH505, NGH507...(Other models you can see in the webshop)		

tension springs

			
1			
Part No.	700191	Ref. No.	131072
description	tension spring ø 30.3mm total length 275mm wire gauge ø 4.1mm		
For models:	LEP400, LGP400, NEP400, NEP600, NEP900, NGP400, NGP600, NGP900		

manometers

			
1			
Part No.	541345	Ref. No.	358107
description	manometer ø 60mm pressure range 0 up to 1.6bar connection on the backside marking 0.5-1 thread 1/4"		
For models:	LES060, LGS060, NDD080, NDD150, NDD250, NDD300, NED080, NED150, NED250, NED300, NEK040, NEK060, NEK080, NEK100, NEK150, NER080, NER150, NER250, NER300, NER400, NER500, NES040, NES060, NES080, NES100, NES150, NGR150, NGR250, NGR300, NGR400, NGS040, NGS060, NGS080, NGS100, NGS150, NHD080, NHD150, NHD250, NHD300, NHR080, NHR100, NHR150, NHR250, NHR300, NHR400, NHR500, NHS040, NHS060, NHS080, NHS100... (Other models you can see in the webshop)		

			
1			
Part No.	541343	Ref. No.	151500 151500+060031
description	manometer ø 63mm pressure range 0 up to 1.6bar thread 1/4" marking 0.5-1 kettle connection on the backside		
For models:	EES060, EES080, EGS060, FED080, FED150, FED250, FED300, FEK040, FEK060, FEK080, FEK100, FEK150, FER080, FER150, FER250, FER300, FER400, FES040, FES060, FES080, FES100, FES150, FGR150, FGR250, FGR300, FGR400, FGS040, FGS060, FGS080, FGS100, FGS150, NER080, NER150, NER250, NER300, NER400, NES040, NES060, NES080, NES100, NES150, NGR150, NGR250, NGR300, NGR400, NGS040, NGS060, NGS080, NGS100, NGS150...(Other models you can see in the web-shop)		

mechanical components,
equipment accessories
1









hose reels and spray guns

cleaning guns



1

Part No.	540553 ¹	Ref. No.	172855
description	cleaning spray gun connection coupling DN13 brass controllable		
For models:	CCE106, CCE110, CCE120, CCE220, CED106, CED110, CED120, CED220, CEF106, CEF110, CEF120, CEF220, CEM110, CEM120, CGD110, CGD120, CPE106, CPE110, CPE120, CPE220		
accessories for	540553		
	Part No.	540485	Ref. No. —
	coupling bush type DN13 chrome-plated brass connection 1/2" (ø13mm)		
	Part No.	540516	Ref. No. —
	coupling bush type DN13 chrome-plated brass connection 1/2" IT		
	Part No.	540640	Ref. No. —
	coupling bush type DN13 chrome-plated brass connection 3/4" IT		
	Part No.	540641	Ref. No. —
	coupling bush type DN13 chrome-plated brass connection 1/2" ET		
	Part No.	540642	Ref. No. —
	coupling bush type DN13 chrome-plated brass connection 3/4" ET		
	Part No.	540643	Ref. No. —
	coupling bush type DN13 chrome-plated brass connection 3/4" (ø19mm)		

¹controllable

dosing pumps

peristaltic dosing pumps





SEKO

wall-mounted version

with speed control



1

Part No.	361157	Ref. No.	150069
description	dosing pump SEKO speed control 1-7l/h 230VAC detergent hose ø 4x6mm hose type K hose Santoprene suction level 1.5m type PR without accessories dimensions 103x82x92mm		
spare parts for	361157		
	Part No.	361136	Ref. No. —
	roller assembly for dosing pump hole ø 4.8x4mm		
	Part No.	361815	Ref. No. —
	pump hose detergent hose ø 6x10mm hose ø 4x6mm hose type K hose Santoprene type SEKO		
accessories for	361157		
	Part No.	361142	Ref. No. —
	mounting set detergent hose type 4x6mm hose length 2m PVC 2x hose/container filter/tank intake transparent		
	Part No.	520090	Ref. No. —
	PVC hose ID ø 4mm ED ø 6mm L 2m thickness 1mm t.max. 60°C transparent		
	Part No.	520091	Ref. No. —
	nylon hose ID ø 4mm ED ø 6mm L 2m thickness 1mm operating p. 10bar burst p. 50bar t.max. 100°C transparent		

membrane dosing pumps

self-priming

LANG



1

Part No.	361032	Ref. No.	409298
description	dosing pump type N6 membrane dosing pump rinse aid pressure connection ø angled, 4x6mm suction connection ø angled, 4x6mm		
For models:	BSA330, KGE122, KGE340, KGE360, KGE660, KGL260, KGL360, KGU113, KGU122, KGU322, KGU340		
spare parts for	361032		
	Part No.	361079	Ref. No. —
	spring for type N5/N6 for ball		

Table continues overleaf



spare parts for		361032	
	Part No.	361080	Ref. No. —
	O-ring EPDM thickness 2mm ID ø 16mm Qty 1 pcs		
	Part No.	361085	Ref. No. —
	O-ring EPDM thickness 2mm ID ø 8mm Qty 1 pcs		
	Part No.	361309	Ref. No. —
	ball for type N5/N6		
	Part No.	361310	Ref. No. —
	bracket for type N6 ball guide		
	Part No.	361311	Ref. No. —
	O-ring EPDM thickness 2mm ID ø 6mm Qty 1 pcs for type N6		
	Part No.	361314	Ref. No. —
	valve ring for type N6 holder for O-ring		
	Part No.	361317	Ref. No. —
	sealing disc for type N6		
	Part No.	361886	Ref. No. —
	non-return valve inletmm outletmm outlet ø 12.4mm L 12.7mm		

hoses

industrial hoses

rubber hoses - Goldschlange®

	1		
Part No.	530540	Ref. No.	407411-425
description	pressure hose ID ø 13mm ED ø 21mm L 5m operating p. 30bar burst p. 90bar t.max. 100°C Qty 5m		

fittings, hose and pipe connectors

hose connectors

without screw connection



1

Part No.	501341	Ref. No.	062214
description	Y-piece plastic hose ø 6-6-6mm		
For models:	CCE120, CCE220, CPE120, CPE220, EES060, EES080, EGS060, FED080, FED150, FED250, FED300, FEK040, FEK060, FEK080, FEK100, FEK150, FER080, FER150, FER250, FER300, FER400, FES040, FES060, FES080, FES100, FES150, FGR150, FGR250, FGR300, FGR400, FGS040, FGS060, FGS080, FGS100, FGS150, NDD080, NDD150, NDD250, NDD300, NED080, NED150, NED250, NED300, NEK040, NEK060, NEK080, NEK100, NEK150, NEM100, NEP203...(Other models you can see in the webshop)		

fittings

reducers



1

Part No.	520181	Ref. No.	166084
description	reducer thread 1/2" ET - 3/8" IT nickel-plated brass total length 15.5mm WS 24		
For models:	FER080, FER150, FER250, FER300, FER400, NER080, NER150, NER250, NER300, NER400, PER088, PER158, PER258, PER308		



valves and tank inlets

ball valves

ball valves electric



1

Part No.	401190	Ref. No.	120110 151006 164011 994595006 994898006 994899006
description	ball valve inlet 3/4" IT outlet 3/4" IT IP42 230V L 68mm 50/60Hz closed off-current mode of operation electric connection cable 300mm 3.5W duty cycle 50%		
For models:	CBE106-VAR091, CBE110-VAR091, CBE120-VAR091, CBE220-VAR091, CCE106, CCE110, CCE120, CCE220, CED106, CED110, CED120, CED220, CEF106, CEF110, CEF120, CEF220, CEM110, CEM120, CPE106, CPE110, CPE120, CPE220		



2

Part No.	400208	Ref. No.	151006
description	ball valve mode of operation electric IT 3/4"		

shut-off valves

universal



1



Part No.	540892	Ref. No.	170287
description	shut-off valve connection soldering connection 1/2" tube ø 15mm cold water total length 54mm rosette thread G2 24x24G shaft ø M4x0.7 ITmm		
For models:	NEM100, NER080, NER150, NER250, NER300, NER400, NER500, NES040, NES060, NES080, NES100, NES150, NEW180, NEW182, NEW250, NEW252, NEW450, NEW452, NGS040, NGS060, NGS080, NGS100, NGS150, NGW250, NGW450, NHR080, NHR100, NHR150, NHR250, NHR300, NHR400, NHR500, NHS040, NHS060, NHS080, NHS100, NHS150, NNR080, NNR150, NNR250, NNR300, NNR400, NNR500, NNS040, NNS060, NNS080, NNS100, NNS150, NNW180, NNW182...(Other models you can see in the webshop)		
spare parts for	540892		
	Part No.	Ref. No.	173588
	tap head connection 1/2" tube ømm hot water total lengthmm		

spare parts for	540892		
	Part No.	Ref. No.	173589
	tap head connection 1/2" tube ømm cold water total lengthmm		



1



Part No.	540891	Ref. No.	170288
description	shut-off valve connection soldering connection 1/2" tube ø 15mm hot water total length 54mm rosette thread G2 24x24G shaft ø M4x0.7 ITmm		
For models:	LES060, LGS060, NDD080, NDD150, NDD250, NDD300, NED080, NED150, NED250, NED300, NEK040, NEK060, NEK080, NEK100, NEK150, NEM100, NER080, NER150, NER250, NER300, NER400, NER500, NES040, NES060, NES080, NES100, NES150, NGR150, NGR250, NGR300, NGR400, NGS040, NGS060, NGS080, NGS100, NGS150, NHD080, NHD150, NHD250, NHD300, NHR080, NHR100, NHR150, NHR250, NHR300, NHR400, NHR500, NHS040, NHS060, NHS080...(Other models you can see in the webshop)		

spare parts for	540891		
	Part No.	Ref. No.	173588
	tap head connection 1/2" tube ømm hot water total lengthmm		
	Part No.	Ref. No.	173589
	tap head connection 1/2" tube ømm cold water total lengthmm		



1

Part No.	540893	Ref. No.	170285
description	shut-off valve connection soldering connection 3/4" tube ø 18mm cold water total length 90mm rosette thread G2 24x24G shaft ø M4x0.7 ITmm		
For models:	NDD080, NDD150, NDD250, NDD300, NEM100, NES040, NES060, NES080, NES100, NES150, NGR150, NGR250, NGR300, NGR400, NGS040, NGS060, NGS080, NGS100, NGS150, NHD080, NHD150, NHD250, NHD300, NHS040, NHS060, NHS080, NHS100, NHS150, NNM100, NNS040, NNS060, NNS080, NNS100, NNS150		

spare parts for	540893		
	Part No.	Ref. No.	172119
	tap head connection 3/4" tube ømm cold water total lengthmm		
	Part No.	Ref. No.	172120
	tap head connection 3/4" tube ømm hot water total lengthmm		





1

Part No.	540894	Ref. No.	170286
description	shut-off valve connection soldering connection 3/4" tube ø 18mm hot water total length 90mm rosette thread G2 24x24G shaft ø M4x0.7 ITmm		
For models:	NDD080, NDD150, NDD250, NDD300, NEM100, NES040, NES060, NES080, NES100, NES150, NGR150, NGR250, NGR300, NGR400, NGS040, NGS060, NGS080, NGS100, NGS150, NHD080, NHD150, NHD250, NHD300, NHS040, NHS060, NHS080, NHS100, NHS150, NNM100, NNS040, NNS060, NNS080, NNS100, NNS150, WES0400, WES0600, WES0800, WES1000, WES1500		
spare parts for	540894		
	Part No.	540900	Ref. No. 172119
	tap head connection 3/4" tube ømm cold water total lengthmm		
	Part No.	540901	Ref. No. 172120
	tap head connection 3/4" tube ømm hot water total lengthmm		



1

Part No.	540900	Ref. No.	172119
description	tap head connection 3/4" tube ømm cold water total lengthmm		
For models:	NDD080, NDD150, NDD250, NDD300, NEM100, NES040, NES060, NES080, NES100, NES150, NGR150, NGR250, NGR300, NGR400, NGS040, NGS060, NGS080, NGS100, NGS150, NHD080, NHD150, NHD250, NHD300, NHS040, NHS060, NHS080, NHS100, NHS150, NNM100, NNS040, NNS060, NNS080, NNS100, NNS150		



1

Part No.	540901	Ref. No.	172120
description	tap head connection 3/4" tube ømm hot water total lengthmm		
For models:	NDD080, NDD150, NDD250, NDD300, NEM100, NES040, NES060, NES080, NES100, NES150, NGR150, NGR250, NGR300, NGR400, NGS040, NGS060, NGS080, NGS100, NGS150, NHD080, NHD150, NHD250, NHD300, NHS040, NHS060, NHS080, NHS100, NHS150, NNM100, NNS040, NNS060, NNS080, NNS100, NNS150		



1

Part No.	540899	Ref. No.	173589
description	tap head connection 1/2" tube ømm cold water total lengthmm		
For models:	LES060, NEM100, NER080, NER150, NER250, NER300, NER400, NER500, NES040, NES060, NES080, NES100, NES150, NEW180, NEW182, NEW250, NEW252, NEW450, NEW452, NGS040, NGS060, NGS080, NGS100, NGS150, NGW250, NGW450, NHR080, NHR100, NHR150, NHR250, NHR300, NHR400, NHR500, NHS040, NHS060, NHS080, NHS100, NHS150, NNR080, NNR150, NNR250, NNR300, NNR400, NNR500, NNS040, NNS060, NNS080, NNS100, NNS150, WES0400...(Other models you can see in the webshop)		



1

Part No.	540898	Ref. No.	173588
description	tap head connection 1/2" tube ømm hot water total lengthmm		
For models:	NDD080, NDD150, NDD250, NDD300, NED080, NED150, NED250, NED300, NEK040, NEK060, NEK080, NEK100, NEK150, NEM100, NER080, NER150, NER250, NER300, NER400, NER500, NES040, NES060, NES080, NES100, NES150, NGR150, NGR250, NGR300, NGR400, NGS040, NGS060, NGS080, NGS100, NGS150, NHD080, NHD150, NHD250, NHD300, NHR080, NHR100, NHR150, NHR250, NHR300, NHR400, NHR500, NHS040, NHS060, NHS080, NHS100, NHS150...(Other models you can see in the webshop)		

steam valves



1

Part No.	541543	Ref. No.	172655
description	steam valve straight connection 1 1/4" IT total length 110mm H 148mm brass		
For models:	NNR080, NNR150, NNR250, NNR300, NNR400, NNR500		
spare parts for	541543		
	Part No.	540229	Ref. No. —
	star handle shaft 9x9mm ø 80mm L 23mm black thermoplastic		
	Part No.	541546	Ref. No. —
	screw chrome-plated brass thread M5 thread L 10mm		



			
1			
Part No.	541542	Ref. No.	172654
description	steam valve straight connection 1" IT total length 90mm H 140mm brass		
For models:	NNM100, NNS080, NNS100, NNS150		
spare parts for	541542		
	Part No.	540229	Ref. No. —
	star handle shaft 9x9mm ø 80mm L 23mm black thermoplastic		
	Part No.	541546	Ref. No. —
	screw chrome-plated brass thread M5 thread L 10mm		
	Part No.	541548	Ref. No. —
	gasket PTFE ID ø 15mm H 7mm for thread 1¼" ED ø 35mm		
	Part No.	541554	Ref. No. —
	gasket copper ext. ø 49 ID ø 42mm H 2mm for thread 1¼"		
	Part No.	541557	Ref. No. —
	tap head chrome-plated thread 1¼" for steam tap 1"		

			
1			
Part No.	541541	Ref. No.	358137
description	steam valve straight connection 3/4" IT total length 75mm H 118mm brass		
For models:	NNA182, NNK040, NNK060, NNK080, NNK100, NNK150, NNS040, NNS060, NNW180, NNW182		
spare parts for	541541		
	Part No.	541546	Ref. No. —
	screw chrome-plated brass thread M5 thread L 10mm		
	Part No.	541547	Ref. No. —
	gasket PTFE ID ø 9.5mm H 7mm for thread 1" ED ø 27.5mm		
	Part No.	541553	Ref. No. —
	gasket copper ext. ø 39 ID ø 33mm H 2mm for thread 1"		
	Part No.	541556	Ref. No. —
	tap head chrome-plated thread 1" for steam tap 3/4"		
	Part No.	541559	Ref. No. —
	star handle shaft 8x8mm ø 80mm L 23mm black thermoplastic		

inlet taps

1

Part No.	540886	Ref. No.	178419
description	inlet spout		



1

Part No.	540887	Ref. No.	178408 178419
description	inlet tap connection 3/4" ET tube ø 20mm projection 100mm overall height 110mm spout height 40mm rotation 90°		
For models:	EES060, EES080, EGS060, FER080, FER150, FER250, FER300, FER400, FES040, FES060, FES080, FES100, FES150, FEW250, FEW252, FGR150, FGR250, FGR300, FGR400, FGS040, FGS060, FGS080, FGS100, FGS150, FGW250, FNR080, FNR150, FNR250, FNR300, FNR400, FNS040, FNS060, FNS080, FNS100, FNS150, NDD080, NDD150, NDD250, NDD300, NEM100, NER080, NER150, NER250, NER300, NER400, NER500, NES040, NES060, NES080, NES100...(Other models you can see in the webshop)		



1

Part No.	540890	Ref. No.	172870
description	inlet tap connection 3/4" ET tube ø 25mm projection 200mm overall height 245mm spout height 70mm rotation 90°		
For models:	FED080, FED150, FED250, FED300, PED088, PED158, PED258, PED308		



connection fittings

screw pipe fittings

 <p>1</p>			
Part No.	543275	Ref. No.	166558
description	screw-in nipple thread 3/8" tube ø 10mm chrome-plated brass		
For models:	CBE106-VAR091, CBE110-VAR091, CBE120-VAR091, CBE220-VAR091, CCE106, CCE110, CCE120, CCE220, CEC106, CEC110, CEC120, CEC220, CED106, CED110, CED120, CED220, CEF106, CEF110, CEF120, CEF220, CEM110, CEM120, CGD110, CGD120, CPE106, CPE110, CPE120, CPE220, FED080, FED150, FED250, FED300, FGR150, FGR250, FGR300, FGR400, NGR150, NGR250, NGR300, NGR400, PED088, PED158, PED258, PED308		

ancillary products

clamps

hose clamps

DIN 3017 - W2

 <p>1</p>			
Part No.	520112	Ref. No.	407427-437
description	hose clamp ø 12-20mm width 9mm Qty 10 pcs DIN 3017		

 <p>1</p>			
Part No.	520114	Ref. No.	407357
description	hose clamp ø 20-32mm width 9mm Qty 10 pcs DIN 3017		
For models:	ECD106, ECD110, ECD120, ECD220		

 <p>1</p>			
Part No.	520115	Ref. No.	407571
description	hose clamp ø 25-40mm width 9mm Qty 10 pcs DIN 3017		
For models:	ECD106, ECD110, ECD120, ECD220		

 <p>1</p>			
Part No.	520118	Ref. No.	260261
description	hose clamp ø 50-70mm width 9mm Qty 5 pcs DIN 3017		
For models:	CED220, KGD020, KGD021, KGD030, KGD040, KGE021, KGE051, KGE052, KGE065, KGH020, KGH030, KGH040, KGS020, KGS021, KGS030, KGU020, KGU021, KGU030		

 <p>1</p>			
Part No.	520117	Ref. No.	407307
description	hose clamp stainless steel ø 40-60mm width 9mm Qty 5 pcs DIN 3017		
For models:	ECD106, ECD110, ECD120, ECD220		

fastening material

screws

hexagonal screws

 <p>1</p>			
Part No.	560309	Ref. No.	356961
description	hexagonal screw thread M10 thread L 16mm SS WS 17 Qty 1 pcs DIN 933 / ISO 4017		
For models:	CEC106, CED106, ECD106, ECD110, ECD120, ECD220		

 <p>1</p>			
Part No.	560308	Ref. No.	151184
description	hexagonal screw thread M16 thread L 20mm SS WS 24 Qty 1 pcs DIN 933 / ISO 4017		
For models:	CBE106, CBE106-VAR091, CBE110, CBE110-VAR091, CBE120, CBE120-VAR091, CBE220, CBE220-VAR091, CBG110, CBG120, CCE106, CCE110, CCE120, CCE220, CED106, CED110, CED120, CED220, CEF106, CEF110, CEF120, CEF220, CEM110, CEM120, CPE106, CPE110, CPE120, CPE220		



			
1			
Part No.	560084	Ref. No.	153475 153479
description	hexagonal screw thread M5 thread L 16mm SS WS 8 Qty 20 pcs DIN 933 / ISO 4017		
For models:	FEH210, FEH410, FEH413, FEH415, FEH610, FEH613, FEH615, LEP400, LES060, LGP400, LGS060, NEF176, NEH210, NEH212, NEH410, NEH413, NEH415, NEH610, NEH613, NEH615, NEP400, NEP600, NEP601, NEP900, NEP901, NGH200, NGH202, NGH400, NGH403, NGH405, NGH407, NGH600, NGH603, NGH605, NGH607, NPG400, NPG600, NPG900, SEB230, SEB430, SEB630, SEF124, SEF144, SEF224, SEF400, SEG220, SEG420, SEG620, SEH200, SER400...(Other models you can see in the webshop)		

hexagonal nuts inch thread			
			
1			
Part No.	520234	Ref. No.	166103
description	nut thread 3/4" H 5mm brass WS 30 Qty 1 pcs		
For models:	CBE120, CBE120-VAR091, CBE220, CBE220-VAR091, CCE120, CCE220, CEC120, CEC220, CED120, CED220, CEF120, CEF220, CEM120, CPE120, CPE220, EES060, EES080, EGS060, FER080, FER150, FER250, FER300, FER400, FES040, FES060, FES080, FES100, FES150, FEW250, FEW252, FGR150, FGR250, FGR300, FGR400, FGS040, FGS060, FGS080, FGS100, FGS150, FGW250, FNR080, FNR150, FNR250, FNR300, FNR400, FNS040, FNS060, FNS080, FNS100, FNS150...(Other models you can see in the webshop)		

nuts

plate nuts

			
1			
Part No.	101922	Ref. No.	155078
description	plate nut hole \varnothing 2.2mm L 13mm W 11mm		
For models:	CAP235		

hexagonal nuts

DIN 934 / ISO 4032/8673

			
1			
Part No.	560133	Ref. No.	154896
description	hexagonal nut thread M6 H 5mm WS 10 SS DIN/ISO DIN 934 / ISO 4032/8673 Qty 20 pcs		
For models:	CEC106, CEC110, CEC120, CEC220, CGD110, CGD120, ECD106, ECD110, ECD120, ECD220, EEF040, EEF124, EEF224, EEW250, EEW400, EEW450, EEW452, FEF180, PEF188		

hexagonal nuts metric (without norm)

			
1			
Part No.	520230	Ref. No.	407298
description	nut thread M14x1.5 H 5mm WS 19 zinc-coated steel Qty 1 pcs		
For models:	ECD106, ECD110, ECD120, ECD220		

washers

washers

DIN 125A

			
1			
Part No.	560312	Ref. No.	407550
description	plain washer ID \varnothing 10.5mm ED \varnothing 20mm thickness 2mm SS Qty 1 pcs DIN 125A for thread M10		
For models:	ECD106, ECD110, ECD120, ECD220		

DIN 9021

			
1			
Part No.	560117	Ref. No.	407575
description	plain washer ID \varnothing 6.4mm ED \varnothing 18mm thickness 1.5mm SS Qty 20 pcs DIN 9021 for thread M6		
For models:	ECD106, ECD110, ECD120, ECD220		

tooth lock washers

DIN 6798A

			
1			
Part No.	560192	Ref. No.	407551
description	tooth lock washer ID \varnothing 10.4mm ED \varnothing 18mm SS DIN/ISO DIN 6798A Qty 1 pcs for thread M10		
For models:	ECD106, ECD110, ECD120, ECD220		



			
1			
Part No.	560127	Ref. No.	156997
description	tooth lock washer ID ø 6.2mm ED ø 11mm SS DIN/ISO DIN 6798A Qty 20 pcs for thread M6		
For models:	ECD106, ECD110, ECD120, ECD220, NGP600, NGP900, SUA401, SUA601		

miscellaneous			
			
1			
Part No.	520228	Ref. No.	40156998
description	tooth lock washer ID ø 15.3mm ED ø 24mm steel Qty 1 pcs for thread M14		

fasteners

clamps

hose clamps

DIN 3017 - W2

			
1			
Part No.	520112	Ref. No.	407427-437
description	hose clamp ø 12-20mm width 9mm Qty 10 pcs DIN 3017		

			
1			
Part No.	520114	Ref. No.	407357
description	hose clamp ø 20-32mm width 9mm Qty 10 pcs DIN 3017		
For models:	ECD106, ECD110, ECD120, ECD220		

			
1			
Part No.	520115	Ref. No.	407571
description	hose clamp ø 25-40mm width 9mm Qty 10 pcs DIN 3017		
For models:	ECD106, ECD110, ECD120, ECD220		

			
1			
Part No.	520118	Ref. No.	260261
description	hose clamp ø 50-70mm width 9mm Qty 5 pcs DIN 3017		
For models:	CED220, KGD020, KGD021, KGD030, KGD040, KGE021, KGE051, KGE052, KGE065, KGH020, KGH030, KGH040, KGS020, KGS021, KGS030, KGU020, KGU021, KGU030		

			
1			
Part No.	520117	Ref. No.	407307
description	hose clamp stainless steel ø 40-60mm width 9mm Qty 5 pcs DIN 3017		
For models:	ECD106, ECD110, ECD120, ECD220		

retaining rings

DIN 471

			
1			
Part No.	529702	Ref. No.	157024
description	retaining ring spindle shaft ø 16mm thickness 1mm steel DIN 471		
For models:	CBG110, CBG120, CGD110, CGD120, NGR150, NGR250, NGR300, NGR400, NGS040, NGS060, NGS080, NGS100, NGS150		

roll pins

			
1			
Part No.	690043	Ref. No.	156938
description	roll pin ø 3mm L 16mm		

			
1			
Part No.	692013	Ref. No.	156938
description	roll pin ø 3mm L 16mm		
For models:	CBE120, CBE120-VAR091, CBE220, CBE220-VAR091, CBG120, CCE120, CCE220, CEC120, CEC220, CED120, CED220, CEF120, CEF220, CEM120, CGD120, CPE120, CPE220, NGP600, NGP900		



consumables

cleaning agents

detergents for coffee machines



1

Part No.	802106	Ref. No.	527287
description	detergent puly CAFF plus approval NSF 200g 10 pouch of 20g		

detergents for milk foamers



1

Part No.	802111	Ref. No.	527288
description	detergents for milk foamers bottle PULY MILK Plus approval NSF 1000ml		

descalers

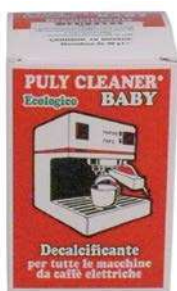

1

Part No.	802117	Ref. No.	527287
description	descaler Puly Cleaner content 0.3kg for coffee and espresso machines		

various cleaners



1

Part No.	890238	Ref. No.	506868 507129
description	detergent for ceramic hobs 0.2l		

fuses

fine fuses



1

Part No.	358696	Ref. No.	216325
description	fine fuse size ø5x20mm 4A medium lag rated 250V Qty 10 pcs		
For models:	CBE106, CBE106-VAR091, CBE110, CBE110-VAR091, CBE120, CBE120-VAR091, CBE220, CBE220-VAR091, CBG110, CBG120, CCE106, CCE110, CCE120, CCE220, CEC106, CEC110, CEC120, CEC220, CED106, CED110, CED120, CED220, CEF106, CEF110, CEF120, CEF220, CEM110, CEM120, CGD110, CGD120, CPE106, CPE110, CPE120, CPE220, EAB051, EEH410, EEH413, EEH500, EEH503, EEH610, EEH613, EEH700, EEH703, EES060, EES080, FEB430, FEB630, FED080, FED150, FED250...(Other models you can see in the webshop)		

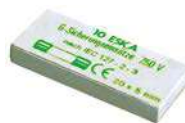

1

Part No.	358598	Ref. No.	407274
description	fine fuse size ø5x20mm 0.63A slow-acting rated 250V Qty 10 pcs		
For models:	ECD106, ECD110, ECD120, ECD220		

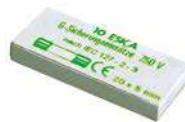

1

Part No.	358608	Ref. No.	216327
description	fine fuse size ø5x20mm 10A slow-acting rated 250V Qty 10 pcs		
For models:	CEC106, CEC110, CEC120, CEC220, CED120, CED220		

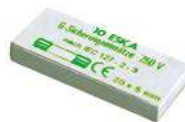

1

Part No.	358607	Ref. No.	407273
description	fine fuse size ø5x20mm 6.3A slow-acting rated 250V Qty 10 pcs		
For models:	ECD106, ECD110, ECD120, ECD220		

fine fuse holders



1

Part No.	358508	Ref. No.	184683
description	fuse holder suitable fuse ø5x25mm		



screw locks

D0-system (NEOZED)

			
1			
Part No.	358045	Ref. No.	407502
description	fuse size D02 35A rated 250/400V E18 ø 15mm L 36mm Qty 10 pcs		
For models:	ECD220		

			
1			
Part No.	358046	Ref. No.	407503
description	fuse size D02 50A rated 250/400V E18 ø 15mm L 36mm Qty 10 pcs		
For models:	ECD220		

gauge pieces (NEOZED)

			
1			
Part No.	358067	Ref. No.	407650
description	gauge piece size D02 suitable for 35A		
For models:	ECD220		

			
1			
Part No.	358068	Ref. No.	407649
description	gauge piece size D02 suitable for 50A		
For models:	ECD220		

GASTROPARTS.COM

