



GASTROPARTS

Komel

- [EN]** Equipment
- [DE]** Geräte
- [ES]** Aparatos
- [FR]** Équipement
- [IT]** Attrezzature
- [PL]** Urządzenia
- [RU]** Оборудование

✉ gastroparts@gastroparts.com

☎ +48 56 657 00 66

📘 fb.com/gastroparts.global

GASTROPARTS.COM





heating elements

heating elements for fryers

2 hole fixing

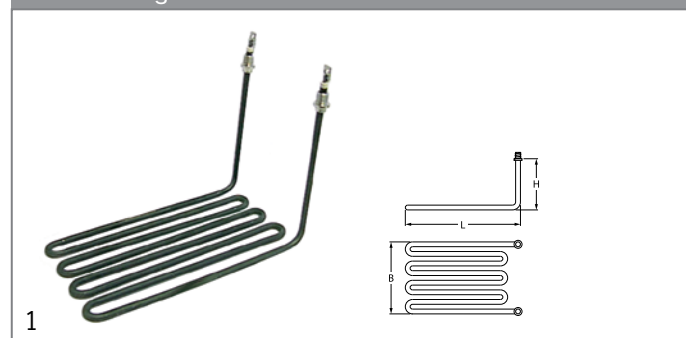

Part No.	415920	Ref. No.	00033120
description	heating element 2800W 230V heating circuits 1 L 280mm W 160mm H 185mm thread 1/4" tube ø 8.5mm windings 4 connection M4 2 hole fixing fryer heaters		
accessories for	415920		
	Part No.	510417	Ref. No. —
	flat gasket fibre ED ø 20mm ID ø 14mm thickness 2mm Qty 1 pcs		
	Part No.	520228	Ref. No. —
	tooth lock washer ID ø 15.3mm ED ø 24mm steel Qty 1 pcs for thread M14		
	Part No.	520230	Ref. No. —
	nut thread M14x1.5 H 5mm WS 19 zinc-coated steel Qty 1 pcs		
	Part No.	521101	Ref. No. —
	nut thread M14x1.5 H 5mm WS 19 SS Qty 1 pcs		
	Part No.	521103	Ref. No. —
	nut thread M4 H 3mm WS 7 brass Qty 20 pcs		
	Part No.	521104	Ref. No. —
	washer ID ø 4.3mm ED ø 8mm thickness 0.5mm brass Qty 20 pcs for thread M4		
	Part No.	550262	Ref. No. —
	flat gasket copper ED ø 20mm ID ø 14mm thickness 2mm		
	Part No.	560111	Ref. No. —
	plain washer ID ø 4.3mm ED ø 9mm thickness 0.8mm SS Qty 20 pcs DIN 125A for thread M4		
	Part No.	560131	Ref. No. —
	hexagonal nut thread M4 H 3.2mm WS 7 SS DIN/ISO DIN 934 / ISO 4032/8673 Qty 20 pcs		

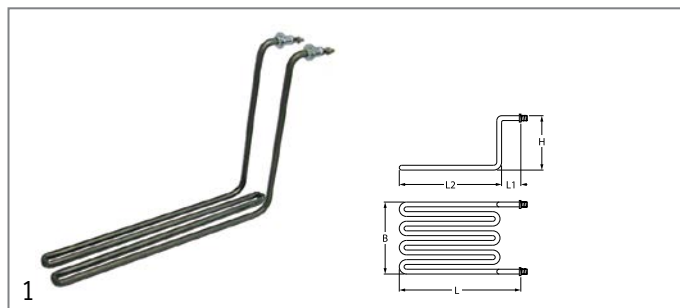

Part No.	415921	Ref. No.	00033130
description	heating element 1260W 230V heating circuits 1 L 320mm W 48mm H 220mm L1 22mm L2 298mm thread 1/4" tube ø 8.5mm windings 2 2 hole fixing connection M4 fryer heaters		
accessories for	415921		
	Part No.	521103	Ref. No. —
	nut thread M4 H 3mm WS 7 brass Qty 20 pcs		
	Part No.	521104	Ref. No. —
	washer ID ø 4.3mm ED ø 8mm thickness 0.5mm brass Qty 20 pcs for thread M4		
	Part No.	560111	Ref. No. —
	plain washer ID ø 4.3mm ED ø 9mm thickness 0.8mm SS Qty 20 pcs DIN 125A for thread M4		
	Part No.	560131	Ref. No. —
	hexagonal nut thread M4 H 3.2mm WS 7 SS DIN/ISO DIN 934 / ISO 4032/8673 Qty 20 pcs		

group 7



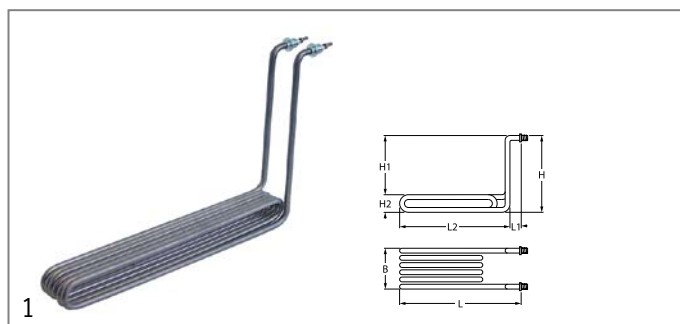

Part No.	420210	Ref. No.	00039276
description	heating element 1600W 230V heating circuits 1 L 283mm W 75mm H 200mm 2 hole fixing connection male faston 6.3mm immersion heater L1 10mm L2 273mm W1 12.5mm W2 50mm H1 20mm H2 180mm tube ø 8.5mm thread 1/4" mounting distance 41.5mm windings 2		









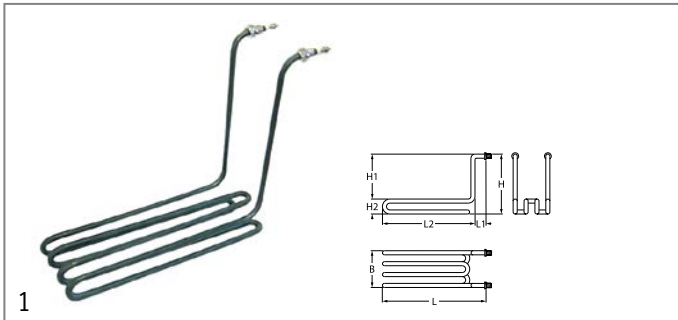

Part No.	416783	Ref. No.	00033154 00033155
description	heating element 5500W 230V heating circuits 1 L 250mm W 60mm H 250mm L1 22mm L2 375mm H1 206mm H2 44mm thread M14x1.5 tube ø 8.5mm 2 hole fixing connection M4 fryer heaters windings 6		
accessories for	416783		
	Part No.	521103	Ref. No. —
	nut thread M4 H 3mm WS 7 brass Qty 20 pcs		

Table continues overleaf







accessories for 416783			
	Part No.	521104	Ref. No. —
	washer ID \varnothing 4.3mm ED \varnothing 8mm thickness 0.5mm brass Qty 20 pcs for thread M4		
	Part No.	560111	Ref. No. —
	plain washer ID \varnothing 4.3mm ED \varnothing 9mm thickness 0.8mm SS Qty 20 pcs DIN 125A for thread M4		
	Part No.	560131	Ref. No. —
	hexagonal nut thread M4 H 3.2mm WS 7 SS DIN/ISO DIN 934 / ISO 4032/8673 Qty 20 pcs		

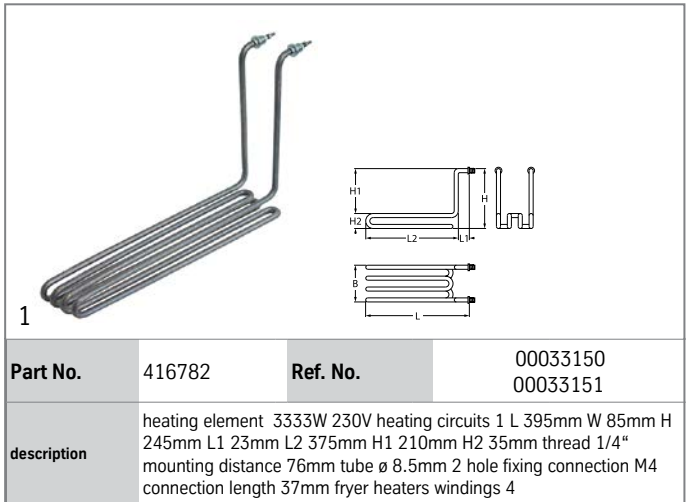

Part No.	Ref. No.	00033142	
description			
heating element 3000W 230V heating circuits 1 L 297mm W 86mm H 243mm L1 22mm L2 275mm H1 207mm H2 36mm thread 1/4" mounting distance 34mm tube \varnothing 8.5mm 2 hole fixing connection M4 fryer heaters windings 4			
accessories for 415924			
	Part No.	361182	Ref. No. —
	nut thread 1/4" H 5mm nickel-plated brass WS 17 Qty 1 pcs		
	Part No.	510417	Ref. No. —
	flat gasket fibre ED \varnothing 20mm ID \varnothing 14mm thickness 2mm Qty 1 pcs		
	Part No.	520228	Ref. No. —
	tooth lock washer ID \varnothing 15.3mm ED \varnothing 24mm steel Qty 1 pcs for thread M14		
	Part No.	521103	Ref. No. —
	nut thread M4 H 3mm WS 7 brass Qty 20 pcs		
	Part No.	521104	Ref. No. —
	washer ID \varnothing 4.3mm ED \varnothing 8mm thickness 0.5mm brass Qty 20 pcs for thread M4		
	Part No.	550262	Ref. No. —
	flat gasket copper ED \varnothing 20mm ID \varnothing 14mm thickness 2mm		
	Part No.	560111	Ref. No. —
	plain washer ID \varnothing 4.3mm ED \varnothing 9mm thickness 0.8mm SS Qty 20 pcs DIN 125A for thread M4		
	Part No.	560131	Ref. No. —
	hexagonal nut thread M4 H 3.2mm WS 7 SS DIN/ISO DIN 934 / ISO 4032/8673 Qty 20 pcs		



Part No.	Ref. No.	00033150	00033151
description			
heating element 3333W 230V heating circuits 1 L 395mm W 85mm H 245mm L1 23mm L2 375mm H1 210mm H2 35mm thread 1/4" mounting distance 76mm tube \varnothing 8.5mm 2 hole fixing connection M4 connection length 37mm fryer heaters windings 4			
accessories for 416782			
	Part No.	521103	Ref. No. —
	nut thread M4 H 3mm WS 7 brass Qty 20 pcs		
	Part No.	521104	Ref. No. —
	washer ID \varnothing 4.3mm ED \varnothing 8mm thickness 0.5mm brass Qty 20 pcs for thread M4		
	Part No.	560111	Ref. No. —
	plain washer ID \varnothing 4.3mm ED \varnothing 9mm thickness 0.8mm SS Qty 20 pcs DIN 125A for thread M4		
	Part No.	560131	Ref. No. —
	hexagonal nut thread M4 H 3.2mm WS 7 SS DIN/ISO DIN 934 / ISO 4032/8673 Qty 20 pcs		

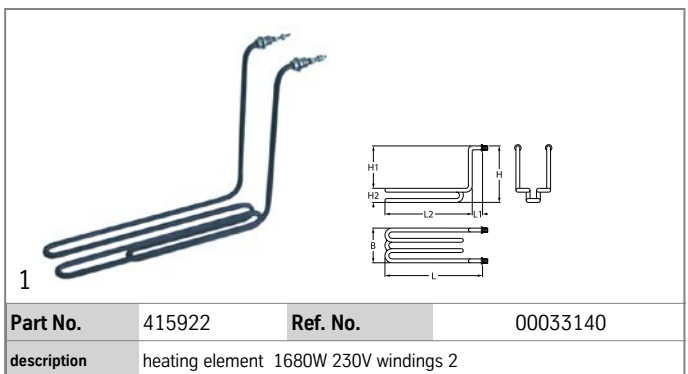

Part No.	Ref. No.	00033140
description		
heating element 1680W 230V windings 2		

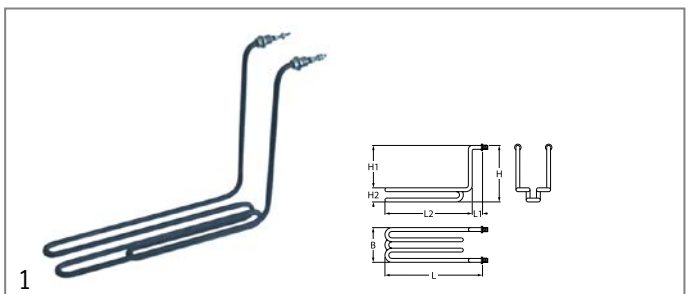

Part No.	Ref. No.	00033141	
description			
heating element 2000W 230V heating circuits 1 L 315mm W 74mm H 250mm L1 20mm L2 295mm H1 214mm H2 36mm thread 1/4" mounting distance 66mm tube \varnothing 8.5mm 2 hole fixing connection M4 fryer heaters windings 2 fryer			
spare parts for 415923			
	Part No.	510417	Ref. No. —
	flat gasket fibre ED \varnothing 20mm ID \varnothing 14mm thickness 2mm Qty 1 pcs		

Table continues overleaf



accessories for		415923	
Part No.		Ref. No.	
	361182		—
nut thread 1/4" H 5mm nickel-plated brass WS 17 Qty 1 pcs			
	520228		—
tooth lock washer ID ø 15.3mm ED ø 24mm steel Qty 1 pcs for thread M14			
	521103		—
nut thread M4 H 3mm WS 7 brass Qty 20 pcs			
	521104		—
washer ID ø 4.3mm ED ø 8mm thickness 0.5mm brass Qty 20 pcs for thread M4			
	550262		—
flat gasket copper ED ø 20mm ID ø 14mm thickness 2mm			
	560111		—
plain washer ID ø 4.3mm ED ø 9mm thickness 0.8mm SS Qty 20 pcs DIN 125A for thread M4			
	560131		—
hexagonal nut thread M4 H 3.2mm WS 7 SS DIN/ISO DIN 934 / ISO 4032/8673 Qty 20 pcs			



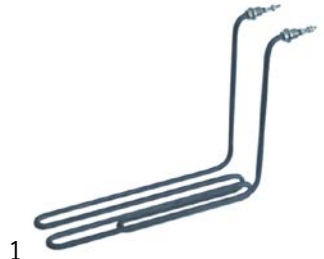
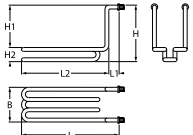

1

Part No.	419056	Ref. No.	00033145
description	heating element 2000W 240V heating circuits 1 L 315mm W 74mm H 250mm L1 20mm L2 295mm H1 214mm H2 36mm thread 1/4" mounting distance 66mm tube ø 8.5mm 2 hole fixing connection M4 fryer heaters windings 2 fryer		

6 hole fixing



1

Part No.	420209	Ref. No.	00039278
description	heating element 9000W 230V heating circuits 3 L 310mm W 180mm H 235mm L1 10mm L2 300mm thread 1/4" mounting distance 34.5mm tube ø 8.5mm 6 hole fixing connection male faston 6.3mm immersion heater fryer		

coil heating elements



1

Part No.	420345	Ref. No.	00055600 00055640
description	heating element 1400W 230V L 285mm W 135mm ø 19.5mm thread 3/8" connection M5 for drying heating circuits 1 2 hole fixing		

immersion heating elements

miscellaneous



1

Part No.	418574	Ref. No.	00203052	
description	heating element 3000W 230V heating circuits 1 L 233mm W 45mm H 29mm rectangular flange hole distance 50mm hole ø 9.5mm connection male faston 6.3mm tube ø 8.5mm flange length 96mm flange width 80mm immersion heater INCOLOY-800			
accessories for	418574			
	Part No.	510401	Ref. No.	00003430
gasket rubber L 88mm W 73mm thickness 5mm hole ø 7mm hole distance 65mm for heating element 4 holes ID ø 50mm				





1

Part No.	415178	Ref. No.	00203049
description	heating element 3000W 230V immersion heater		



1



Part No.	418548	Ref. No.	00003325	
description	heating element 5200W 230V heating circuits 3 L 325mm W 47mm H 50mm tube ø 8.5mm hole distance 62mm hole ø 9.3mm connection M4 4 hole flange immersion heater flange width 81mm flange length 96mm with thermal fuse			
spare parts for	418548			
	Part No.	510401	Ref. No.	00003430
gasket rubber L 88mm W 73mm thickness 5mm hole ø 7mm hole distance 65mm for heating element 4 holes ID ø 50mm				











1



Part No.	415031	Ref. No.	00003324	
description	heating element 5700W 230V heating circuits 3			
accessories for	415031			
	Part No.	510401	Ref. No.	00003430
gasket rubber L 88mm W 73mm thickness 5mm hole ø 7mm hole distance 65mm for heating element 4 holes ID ø 50mm				







			
Part No.	415032	Ref. No.	00003330 00003334
description	heating element 7500W 230V heating circuits 3 4 hole flange immersion heater		
accessories for	415032		
	Part No.	510401	Ref. No. 00003430
	gasket rubber L 88mm W 73mm thickness 5mm hole ø 7mm hole distance 65mm for heating element 4 holes ID ø 50mm		
	Part No.	521103	Ref. No. —
	nut thread M4 H 3mm WS 7 brass Qty 20 pcs		
	Part No.	521104	Ref. No. —
	washer ID ø 4.3mm ED ø 8mm thickness 0.5mm brass Qty 20 pcs for thread M4		
	Part No.	560111	Ref. No. —
	plain washer ID ø 4.3mm ED ø 9mm thickness 0.8mm SS Qty 20 pcs DIN 125A for thread M4		
	Part No.	560131	Ref. No. —
	hexagonal nut thread M4 H 3.2mm WS 7 SS DIN/ISO DIN 934 / ISO 4032/8673 Qty 20 pcs		

			
Part No.	415033	Ref. No.	00003349 old version
description	heating element 9000W 230V heating circuits 3 L 322mm W 37mm H 68mm tube ø 6.3mm hole distance 67/45mm hole ø 10mm connection M4 4 hole flange immersion heater		
accessories for	415033		
	Part No.	510401	Ref. No. 00003430
	gasket rubber L 88mm W 73mm thickness 5mm hole ø 7mm hole distance 65mm for heating element 4 holes ID ø 50mm		
	Part No.	521103	Ref. No. —
	nut thread M4 H 3mm WS 7 brass Qty 20 pcs		
	Part No.	521104	Ref. No. —
	washer ID ø 4.3mm ED ø 8mm thickness 0.5mm brass Qty 20 pcs for thread M4		
	Part No.	560111	Ref. No. —
	plain washer ID ø 4.3mm ED ø 9mm thickness 0.8mm SS Qty 20 pcs DIN 125A for thread M4		
	Part No.	560131	Ref. No. —
	hexagonal nut thread M4 H 3.2mm WS 7 SS DIN/ISO DIN 934 / ISO 4032/8673 Qty 20 pcs		

			
Part No.	420213	Ref. No.	00003335
description	heating element 9000W 240V heating circuits 3 L 483mm W 46mm H 40mm tube ø 8.5mm hole distance 65mm hole ø 9.5mm connection M4 4 hole flange immersion heater flange width 81mm flange length 96mm		
accessories for	420213		
	Part No.	510401	Ref. No. 00003430
	gasket rubber L 88mm W 73mm thickness 5mm hole ø 7mm hole distance 65mm for heating element 4 holes ID ø 50mm		

			
Part No.	418879	Ref. No.	00003349
description	heating element 9800W 230V heating circuits 3 L 322mm W 37mm H 68mm number of thermostat sleeves 2 thermostat sleeves ø 6.5/10mm length thermostat sleeves 185/80mm tube ø 6.3mm hole distance 65/45mm hole ø 10mm connection M4 4 hole flange immersion heater flange width 81mm flange length 96mm		
accessories for	418879		
	Part No.	510401	Ref. No. 00003430
	gasket rubber L 88mm W 73mm thickness 5mm hole ø 7mm hole distance 65mm for heating element 4 holes ID ø 50mm		

1 1/4"			
			
Part No.	415153	Ref. No.	00003270
description	heating element 5700W 230V heating circuits 3 thread 1 1/4" L 300mm W 85mm H 42mm L1 120mm L2 180mm W1 29mm W2 28mm H1 21mm H2 21mm tube ø 6.3mm connection male faston 6.3mm connection length 40mm flange with thread immersion heater		
spare parts for	415153		
	Part No.	510405	Ref. No. —
	flat gasket fibre ED ø 56mm ID ø 42mm thickness 2mm for thread 1 1/4" Qty 1 pcs		
accessories for	415153		
	Part No.	520232	Ref. No. —
	nut thread 1 1/4" H 5mm nickel-plated brass WS 47 Qty 1 pcs		
	Part No.	528021	Ref. No. —
	flat gasket PTFE ED ø 53mm ID ø 42.5mm thickness 3mm Qty 1 pcs equiv. no. 12001/02286 suitable for Astoria/Aurora/Brasilia/Wega		

			
Part No.	418981	Ref. No.	00003277
description	heating element 1000/1300/1400W 200/230/240V heating circuits 1 L 213mm W 67mm H 29mm thread 1/4" mounting distance 61mm tube ø 6.3mm connection male faston 6.3mm immersion heater		











			
Part No.	416281	Ref. No.	00203091
description	heating element 2000W 230V heating circuits 1 L 300mm W 76mm H 30mm thread 1/4" mounting distance 80mm tube ø 6.3mm connection male faston 6.3mm 2 hole fixing connection length 15mm immersion heater		
spare parts for	416281		
	Part No.	510417	Ref. No. —
	flat gasket fibre ED ø 20mm ID ø 14mm thickness 2mm Qty 1 pcs		

Table continues overleaf



accessories for	416281			
	Part No.	361182	Ref. No.	—
	nut thread 1/4" H 5mm nickel-plated brass WS 17 Qty 1 pcs			
	Part No.	520228	Ref. No.	—
	tooth lock washer ID ø 15.3mm ED ø 24mm steel Qty 1 pcs for thread M14			
	Part No.	550262	Ref. No.	—
	flat gasket copper ED ø 20mm ID ø 14mm thickness 2mm			

	1		
Part No.	415176	Ref. No.	00203089
description	heating element 2700W 230V heating circuits 1 L 350mm W 70mm thread 1/4" mounting distance 64mm tube ø 6.25mm 2 hole fixing immersion heater connection male faston 6.3mm		

	1			
Part No.	416282	Ref. No.	00018070	
description	heating element 3200W 230V heating circuits 1 L 350mm W 77mm H 33mm thread 1/4" mounting distance 71mm tube ø 6.3mm connection male faston 6.3mm 2 hole fixing immersion heater			
spare parts for	416282			
	Part No.	510417	Ref. No.	—
	flat gasket fibre ED ø 20mm ID ø 14mm thickness 2mm Qty 1 pcs			
accessories for	416282			
	Part No.	361182	Ref. No.	—
	nut thread 1/4" H 5mm nickel-plated brass WS 17 Qty 1 pcs			
	Part No.	520228	Ref. No.	—
	tooth lock washer ID ø 15.3mm ED ø 24mm steel Qty 1 pcs for thread M14			
	Part No.	550262	Ref. No.	—
	flat gasket copper ED ø 20mm ID ø 14mm thickness 2mm			

thermostats

bi-metal thermostats

safety bi-metal thermostats

	1		
Part No.	390748	Ref. No.	22110020
description	bi-metal safety thermostat hole distance 23.5mm switch-off temp. 100°C 1NC 1-poleA connection F6.3		

	1		
Part No.	390681	Ref. No.	22110021
description	bi-metal safety thermostat hole distance 40mm switch-off temp. 105°C 2NC 2-pole 16A 250V connection F6.3		

	1		
Part No.	375757	Ref. No.	22110020 old version
description	bi-metal safety thermostat switch-off temp. 100°C 1NC 1-pole 16A connection F6.3		

bi-metal thermostats

	1		
Part No.	390909	Ref. No.	22180101
description	bi-metal thermostat hole distance 46mm switch-off temp. 56°C 1NC 1-pole 16A 250V connection F6.3 Qty 1 pcs		

control and safety thermostats

EGO

control thermostats

55.10/19_ series

	1		
Part No.	390731	Ref. No.	22140002
description	thermostat t.max. 195°C temperature range 65-195°C 1-pole 1NO 16A probe ø 4mm probe L 106mm capillary pipe 1470mm capillary pipe isolatedmm gland nut shaft ø 6x4.6mm shaft L 23mm shaft position° shaft position upper rotation 270°		



Part No. 390174 **Ref. No.** 22140001
3323

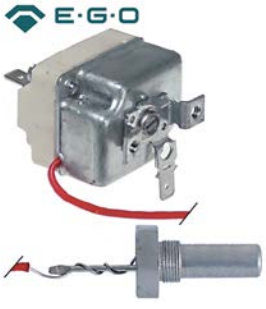

description thermostat t.max. 204°C temperature range 65-204°C 1-pole 1NO 16A probe ø 4mm probe L 89mm capillary pipe 600mm capillary pipe isolatedmm gland nut shaft ø 6x4.6mm shaft L 23mm shaft position upper rotation 270° probe material SS



Part No. 390172 **Ref. No.** 00057151

description thermostat t.max. 50°C temperature range fixed 50°C 1-pole 1CO 16A probe ø 11mm probe L 45mm capillary pipe 850mm capillary pipe isolated 830mm gland nut shaft Lmm shaft position screw-in probe probe thread 3/8"

accessories for 390172

	Part No. 506024	Ref. No.	—
	nut thread 3/8" H 6mm SS WS 22 Qty 1 pcs		
	Part No. 521137	Ref. No.	—
	flat gasket fibre ED ø 20mm ID ø 18mm thickness 1.5mm for thread 3/8" Qty 1 pcs		



Part No. 375534 **Ref. No.** 22180004

description thermostat t.max. 90°C temperature range 19-90°C 1-pole 1CO 16A probe ø 6mm probe L 129mm capillary pipe 980mm capillary pipe isolated 960mm gland nut shaft Lmm shaft position rotation 180°

55.34_ series



Part No. 390057 **Ref. No.** 22160001

description thermostat t.max. 192°C temperature range 100-192°C 3-pole 3NO 16A probe ø 7mm probe L 200mm capillary pipe 870mm capillary pipe isolatedmm gland nut shaft ø 6x4.6mm shaft L 23mm shaft position upper° rotation 270°



Part No. 390043 **Ref. No.** 00003190

description thermostat t.max. 80°C temperature range fixed 80°C capillary pipe isolatedmm gland nut



Part No. 390042 **Ref. No.** 0000319A
22190001

description thermostat t.max. 85°C temperature range 35-85°C 3-pole 3CO 16A probe ø 9.5mm probe L 80mm capillary pipe 870mm capillary pipe isolatedmm gland nut shaft ø 6x4.6mm shaft L 23mm shaft position upper° rotation 180° with disc ø 10mm



safety thermostats

55.10/19_ series



Part No.	390738	Ref. No.	22180100
description	safety thermostat switch-off temp. 107°C 1-pole 16A probe ø 6mm probe L 77mm capillary pipe 1170mm capillary pipe isolated 1150mm gland nut probe material SS		

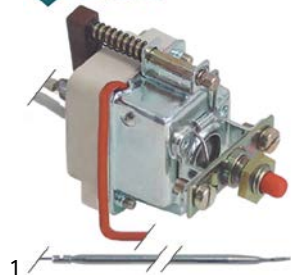

Part No.	375178	Ref. No.	22170001
description	safety thermostat switch-off temp. 230°C 1-pole 0.5A probe ø 4mm probe L 116mm capillary pipe 1500mm capillary pipe isolatedmm gland nut probe SS		



Part No.	390730	Ref. No.	22170003
description	safety thermostat switch-off temp. 230°C 1-pole 0.5A probe ø 4mm probe L 125mm capillary pipe 1550mm capillary pipe isolated 1410mm gland nut probe		

55.14_ series



Part No.	390176	Ref. No.	22130001 3227
description	safety thermostat switch-off temp. 230°C 1-pole 16A probe ø 6mm probe L 74mm capillary pipe 600mm capillary pipe isolatedmm gland nut probe SS		

55.31_ series



Part No.	390091	Ref. No.	22150001
description	safety thermostat switch-off temp. 230°C 3-pole 20A probe ø 6mm probe L 239mm capillary pipe 830mm capillary pipe isolatedmm gland nut probe SS 380V		

55.32_ series

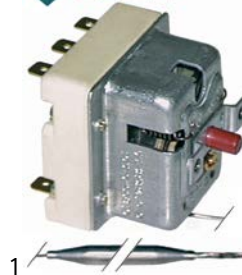

Part No.	390178	Ref. No.	22100002
description	safety thermostat switch-off temp. 124°C 3-pole 20A probe ø 6mm probe L 74mm capillary pipe 900mm capillary pipe isolated 900mm gland nut probe SS		



55.33_ series



Part No.	375796	Ref. No.	00032280 22150002 22150003
description	safety thermostat switch-off temp. 220°C 3-pole 3NC 20A probe ø 6mm probe L 107mm capillary pipe 870mm capillary pipe isolated 800mm gland nut probe		

56._ series



Part No.	390714	Ref. No.	00032270
description	safety thermostat switch-off temp. 230°C 1-pole 1NC 16A probe ø 6mm probe L 75mm capillary pipe 740mm capillary pipe isolated 200mm gland nut probe SS		

IMIT / TEMPOMATIC / ARTHERMO

control thermostats



Part No.	390173	Ref. No.	00057150
description	thermostat t.max. 87°C temperature range 27-87°C 1-pole 1CO 15A probe ø 6.5mm probe L 95mm capillary pipe 1000mm capillary pipe isolated 1000mm gland nut shaft ø 6x4.6mm shaft L 19mm rotation 270° with disc disc ø 14.5mm		

accessories for 390173

	Part No.	110100	Ref. No.	—
	description	knob thermostat t.max. 90°C 0-90°C ø 42mm shaft ø 6x4.6mm shaft flat -135° black		

	Part No.	110310	Ref. No.	—
	description	rosette knob up to ø 45mm		

safety thermostats



Part No.	375850	Ref. No.	22130002
description	safety thermostat switch-off temp. 230°C 1-pole 1NC 15A probe ø 3.5mm probe L 200mm capillary pipe 950mm capillary pipe isolatedmm gland nut probe SS 250V		



Part No.	375851	Ref. No.	00032610
description	safety thermostat switch-off temp. 230°C 1-pole capillary pipe isolatedmm gland nut probe		

various

control thermostats

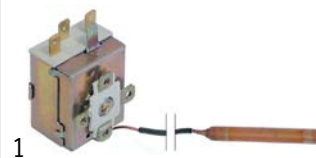

Part No.	390196	Ref. No.	22180004 old version
description	thermostat t.max. 93°C temperature range 35-93°C 1-pole		

accessories

fitting parts

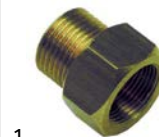

Part No.	511627	Ref. No.	00003400
description	screw connection for boiler IT M16x1 ET 3/8"		



gland ducts



Part No.	551076	Ref. No.	00038680
description	gland duct ET M11x1 IT M10x1 probe ø max. 4mm WS 22 copper stainless steel L 30mm		



plunger sockets

			
1			
Part No.	550139	Ref. No.	00030500
description	thermowell thread 3/4" L 310mm SS double ø 8mm hole ø 7mm		
accessories for	550139		
			
	Part No.	520234	Ref. No.
			—
	nut thread 3/4" H 5mm brass WS 30 Qty 1 pcs		

miscellaneous

			
1			
Part No.	550268	Ref. No.	00032290
description	cover cap for push-button		

switches and momentary switches

push/momentary push switches

17x13mm

			
1			
Part No.	345950	Ref. No.	28160041
description	momentary push switch mounting measurements 17x13mm grey 2CO 250V 16A connection male faston 6.3mm ambient temperature max. 150/75°C protection IP40		

20.6x16.4mm

			
1			
Part No.	345948	Ref. No.	28160039
description	momentary push switch mounting measurements 20.6x16.4mm grey 2CO 250V 16A outflow connection male faston 6.3mm ambient temperature max. 150°C protection IP40		

			
1			
Part No.	345949	Ref. No.	28160040
description	push switch mounting ø 20.6x16.4mm grey 2CO 250V 16A connection male faston 6.3mm ambient temperature max. 150°C protection IP40		

28.5x28.5mm

			
1			
Part No.	345940	Ref. No.	28160020
description	momentary push switch mounting measurements 28.5x28.5mm grey 2CO 240V 16A connection male faston 6.3mm ambient temperature max. 150°C protection IP40		

			
1			
Part No.	345942	Ref. No.	28160024
description	push switch mounting measurements 28.5x28.5mm grey 2CO 250V 16A connection male faston 6.3mm ambient temperature max. 150°C protection IP40		

			
1			
Part No.	345953	Ref. No.	28160273
description	push switch mounting measurements 28.5x28.5mm grey 2CO 250V 16A connection male faston 6.3mm ambient temperature max. 150°C protection IP40		

			
1			
Part No.	345943	Ref. No.	28160026 28160272
description	momentary push switch mounting measurements 28.5x28.5mm grey 2CO 250V 16A clock connection male faston 6.3mm ambient temperature max. 125/55°C protection IP40		

			
1			
Part No.	345941	Ref. No.	28160022
description	momentary push switch mounting measurements 28.5x28.5mm grey 2CO 250V 16A drain pump connection male faston 6.3mm ambient temperature max. 150°C protection IP40		

			
1			
Part No.	345947	Ref. No.	28160037
description	momentary push switch mounting measurements 28.5x28.5mm grey 2CO 250V 16A drain pump connection male faston 6.3mm ambient temperature max. 150°C protection IP40		



28.5x77.5mm



1

Part No.	345944	Ref. No.	28160028
-----------------	--------	-----------------	----------

description	switch combination latching mounting measurements 28.5x77.5mm grey 2CO 250V 16A main switch connection male faston 6.3mm ambient temperature max. 85°C protection IP40
--------------------	--



1

Part No.	345954	Ref. No.	28160274
-----------------	--------	-----------------	----------

description	switch combination latching mounting measurements 28.5x77.5mm grey 2CO/2CO/2CO 250V 16A connection male faston 6.3mm ambient temperature max. 85°C protection IP40
--------------------	--



1

Part No.	345945	Ref. No.	28160029
-----------------	--------	-----------------	----------

description	switch combination latching mounting measurements 28.5x77.5mm grey 2CO/2CO/2CO 250V 16A main switch/program/drain pump connection male faston 6.3mm ambient temperature max. 85°C protection IP40
--------------------	---



1

Part No.	345180	Ref. No.	28160021 28160023
-----------------	--------	-----------------	----------------------

description	switch combination mounting measurements 28.5x77.5mm grey 1CO/1CO/1CO 250V 16A connection male faston 6.3mm ambient temperature max. 85°C protection IP40
--------------------	---



1

Part No.	345946	Ref. No.	28160036
-----------------	--------	-----------------	----------

description	switch combination mounting measurements 28.5x77.5mm grey 2CO/2CO/2CO 250V 16A double arrow/arrow/main switch connection male faston 6.3mm ambient temperature max. 85°C protection IP40
--------------------	--

miscellaneous



1

Part No.	345951	Ref. No.	28160043
-----------------	--------	-----------------	----------

description	momentary push switch grey 2CO 250V 16A without frame drain connection male faston 6.3mm ambient temperature max. 85°C
--------------------	--



1

Part No.	345952	Ref. No.	28160044
-----------------	--------	-----------------	----------

description	momentary push switch grey 2CO 250V 16A without frame rinsing connection male faston 6.3mm ambient temperature max. 85°C
--------------------	--

microswitches

lever actuated



1

Part No.	345183	Ref. No.	25190005
-----------------	--------	-----------------	----------

description	microswitch with double lever 250V 16A 2CO connection male faston 6.3mm L 50mm ambient temperature max. 125°C mounting distance 22.5mm type N16 actuating force: 290g lever length 47mm
--------------------	---



1

Part No.	345178	Ref. No.	25190003
-----------------	--------	-----------------	----------

description	microswitch with lever 250V 16A 1CO connection male faston 6.3mm L 28mm L1 37mm ambient temperature max. 125°C mounting distance 22mm actuating force: 220g lever length 33mm
--------------------	---





1

Part No.	345255	Ref. No.	25190007
-----------------	--------	-----------------	----------

description	microswitch with lever 250V 16A 1CO connection male faston 6.3mm L 35mm L1 28mm ambient temperature max. 125°C mounting distance 22mm actuating force: 136g lever length 27mm
--------------------	---





roller-lever actuated			
non-standard			
			
1			
Part No.	345186	Ref. No.	00006390 25190001
description	microswitch with handle with a switch 250V 15A 1CO connection male faston 6.3mm L 42mm ambient temperature max. 85°C lever length 37mm		

accessories			
			
1			
Part No.	511892	Ref. No.	00011115
description	actuator for microswitch kit		

			
1			
Part No.	511081	Ref. No.	00011100
description	actuator microswitch		

			
1			
Part No.	511111	Ref. No.	00006410
description	actuator microswitch kit		

			
1			
Part No.	511119	Ref. No.	00011090
description	actuator microswitch kit		

			
1			
Part No.	511112	Ref. No.	00006401 640H
description	lever for microswitch		

position switches

LOVATO			
			
1			
Part No.	347579	Ref. No.	25190004
description	position switch plastic 1NO/1NC 400V 3A L 110mm W 30mm H 44mm protection IP66/67 actuating force: 380g screw connection M16 mounting distance 22mm type ZCP21		

TELEMECANIQUE (EFA)			
			
1			
Part No.	347579	Ref. No.	25190004
description	position switch plastic 1NO/1NC 400V 3A L 110mm W 30mm H 44mm protection IP66/67 actuating force: 380g screw connection M16 mounting distance 22mm type ZCP21		

			
1			
Part No.	347903	Ref. No.	00073790 25190002
description	position switch plastic 1NO/1NC 400V 3A L 110mm W 30mm H 44mm protection IP66/67 actuating force: 380g screw connection M16 mounting distance 22mm type ZCP21		

system switches (ROLD)

			
1			
Part No.	347193	Ref. No.	28160253
description	momentary switch unit 1NO 250V 16A connection male faston 6.3mm		

			
1			
Part No.	346256	Ref. No.	28160214
description	push button ø 23mm grey clock no lens		

			
1			
Part No.	346253	Ref. No.	28160213
description	push button ø 23mm grey main switch		

			
1			
Part No.	347504	Ref. No.	28160250
description	switch 2CO 250V 16A connection male faston 6.3mm		



rotary switches

BRETER

rotary switches



1

Part No.	345165	Ref. No.	25100102 old version
description	rotary switch 16A 2-pole		



1

Part No.	345015	Ref. No.	00005980
description	rotary switch 16A connection screw clamp 3-pole shaft 5x5mm		



1

Part No.	345166	Ref. No.	25120001 old version
description	rotary switch 4-pole		

TECNOMATIC



1

Part No.	345016	Ref. No.	0000597A 25100001
description	rotary switch 2 0-1 sets of contacts 1 type HD1201R000 600V 12A shaft ø 5x5mm shaft L 23mm shaft square connection screw		



1

Part No.	347055	Ref. No.	25100102
description	rotary switch 2 0-1 sets of contacts 2 type HD1602R000 600V 16A shaft ø 5x5mm shaft L 23mm shaft square connection screw		

magnetic switches

36x13mm



1

Part No.	345955	Ref. No.	25110113
description	magnetic switch L 36mm W 13mm connection cable		

65x20mm



1

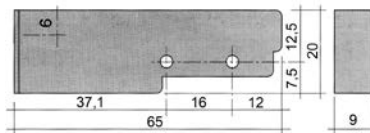

Part No.	345116	Ref. No.	25240003
description	magnetic switch L 65mm W 20mm 1NO 250V 0.4A P max. 100W connection cable cable length 3000mm		

accessories for 345116

	Part No.	345399	Ref. No.	—
		magnet ø 3.3mm L 40mm H 8mm W 13mm hole distance 30mm M3		

accessories

magnets

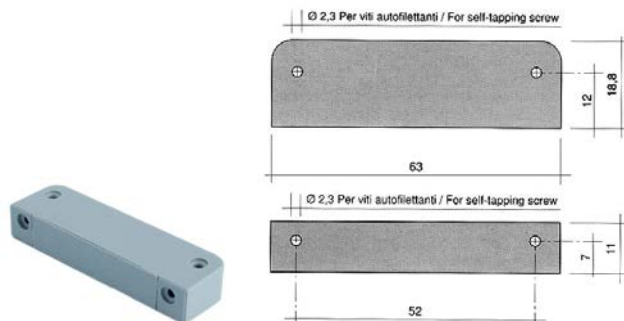

1

Part No.	519049	Ref. No.	25110115
description	magnet ømm L 63mm H 10.7mm W 18.8mm hole distance 52mm M2 hole ø 2mm		

accessories for 519049

	Part No.	560095	Ref. No.	—
		sheet metal screws ø 2.9mm L 9.5mm SS Qty 20 pcs DIN 7981/ISO 7049 head ø 5.6mm oval head		





miscellaneous			
			
1			
Part No.	347904	Ref. No.	00065606
description	holding plate L 62mm W 26mm for magnetic switch		

indicator lights (complete)			
ø 6mm			
			
1			
Part No.	359005	Ref. No.	28100006
description	indicator light ø 6mm 230V yellow cable length 400mm		

control equipment

TELEMECANIQUE (EFA)

ZB4 series			
switches (complete)			
			
1			
Part No.	346925	Ref. No.	00061070
description	rotary selector mounting measurements ø22mm latching white illuminated rotation 90° sequence 0-1		
spare parts for	346925		
	Part No.	347385	Ref. No.
			—
	contact block EFA ZBE-101 1NO max 230V 10(6)A black		

ø10mm			
with plug-in socket			
			
1			
Part No.	359140	Ref. No.	28100007
description	indicator light ø 10mm yellow 230V connection male faston 6.3mm Qty 1 pcs		

			
1			
Part No.	347905	Ref. No.	00061060
description	rotary selector mounting measurements ø22mm latching white illuminated sequence 0-1		

ø13mm			
with screw socket			
			
1			
Part No.	359146	Ref. No.	28100011
description	indicator light ø 13mm 230V yellow		
accessories for	359146		
	Part No.	510302	Ref. No.
			—
	O-ring EPDM ID ø 12.42mm thickness 1.78mm Qty 1 pcs		
	Part No.	511505	Ref. No.
			—
	O-ring EPDM thickness 1.78mm ID ø 12.42mm Qty 10 pcs		

lamps

indicator lights

lamps			
light bulbs			
			
1			
Part No.	359236	Ref. No.	00006460 28130003
description	light bulb socket E10 24V 3W ø 10mm L 28mm		

			
1			
Part No.	359049	Ref. No.	28100001
description	indicator light ø 13mm 400V green		
accessories for	359049		
	Part No.	510302	Ref. No.
			—
	O-ring EPDM ID ø 12.42mm thickness 1.78mm Qty 1 pcs		
	Part No.	511505	Ref. No.
			—
	O-ring EPDM thickness 1.78mm ID ø 12.42mm Qty 10 pcs		

with plug-in socket			
			
1			
Part No.	359119	Ref. No.	28100004
description	indicator light ø 13mm green 24V connection male faston 6.3mm Qty 1 pcs		



33x10mm



1

Part No.	359452	Ref. No.	28110001 28110001 + 00038828 3320
description	indicator light mounting measurements 33.1x10.3mm 400V green connection male faston 6.3mm		



1

Part No.	359451	Ref. No.	003321 28110002 28110002 + 00038828
description	indicator light mounting measurements 33.1x10.3mm 400V yellow connection male faston 6.3mm		

miscellaneous



1

Part No.	357123	Ref. No.	28100014
description	indicator light red 230V connection cable ø 8mm		

screw-on/push-on fit

light bulbs

for indicator lights



1

Part No.	359236	Ref. No.	00006460 28130003
description	light bulb socket E10 24V 3W ø 10mm L 28mm		

timers

programme timers



1

Part No.	360654	Ref. No.	26100024
description	timer CDC 11804F1 engines 1 chambers 4 operation time 120s 230V shaft ømm shaft Lmm		



1

Part No.	360653	Ref. No.	26100023
description	timer CDC 11804F1 engines 1 chambers 4 operation time 180s 230V		



1

Part No.	360069	Ref. No.	26100017
description	timer CROUZET engines 1 chambers 4 operation time 120s 230V shaft ømm shaft Lmm manuf. no. 645/5245 motor type 82340		



1

Part No.	360068	Ref. No.	26100019
description	timer CROUZET engines 1 chambers 5 operation time 90s 230V shaft ømm shaft Lmm manuf. no. 645/5238 motor type 82340		



1

Part No.	360081	Ref. No.	00005930 26100015
description	timer FIBER P25 engines 1 chambers 4 operation time 120s 24V shaft ø 5x5mm shaft L 20mm manuf. no. P255204H313 motor type M51B20L6400		



spare parts for 360081

Part No.	360676	Ref. No.	—
description	motor kit pinion ø 6.8mm teeth 15 24V voltage AC 50/60Hz turn direction counterclockwise motor ø 48mm H 18.5mm motor type UDS40NE1RNZ165 cable length 150mm with holder		







1

Part No.	360304	Ref. No.	26100022
description	timer FIBER P25 engines 2 chambers 4 operation time 2min / 7.5min 230V shaft ømm shaft Lmm manuf. no. P255J04LXP8 motor type M51BJ0R6400 / M51BJ0L6400		
spare parts for	360304		
	Part No.	360673	Ref. No. —
	motor kit pinion ø 6.8mm teeth 15 230V voltage AC 50/60Hz turn direction clockwise motor ø 48mm H 18.5mm motor type UDS-40NE1RNZ165 cable length 150mm with holder		
	Part No.	360674	Ref. No. —
	motor kit pinion ø 6.8mm teeth 15 230V voltage AC 50/60Hz turn direction counterclockwise motor ø 48mm H 18.5mm motor type UDS40NE1RNZ165 cable length 150mm with holder		

1

Part No.	360305	Ref. No.	26100025
description	timer FIBER PWE engines 1 chambers 1 operation time 20min 230V shaft ømm shaft Lmm manuf. no. PWE5J01L103 motor type M51BJ0R6400		
spare parts for	360305		
	Part No.	360673	Ref. No. —
	motor kit pinion ø 6.8mm teeth 15 230V voltage AC 50/60Hz turn direction clockwise motor ø 48mm H 18.5mm motor type UDS-40NE1RNZ165 cable length 150mm with holder		

1

Part No.	360303	Ref. No.	26100021
description	timer FIBER P25 engines 2 chambers 5 operation time 72s / 4.8min 230V shaft ømm shaft Lmm manuf. no. P255J05ANM0 motor type M51BJ0R6400 / M51BJ0L6400		
spare parts for	360303		
	Part No.	360673	Ref. No. —
	motor kit pinion ø 6.8mm teeth 15 230V voltage AC 50/60Hz turn direction clockwise motor ø 48mm H 18.5mm motor type UDS-40NE1RNZ165 cable length 150mm with holder		
	Part No.	360674	Ref. No. —
	motor kit pinion ø 6.8mm teeth 15 230V voltage AC 50/60Hz turn direction counterclockwise motor ø 48mm H 18.5mm motor type UDS40NE1RNZ165 cable length 150mm with holder		

1



Part No.	360087	Ref. No.	26100011
description	timer FIBER P26 engines 1 chambers 3 operation time 20min 230V shaft ømm shaft Lmm manuf. no. P265J03L130 motor type M61B40R6400		

contactors



GENERAL ELECTRIC (AEG)

power contactors

1

			
Part No.	380245	Ref. No.	25130028
description	power contactor resistive load 25A 230VAC (AC3/400V) 9A/4kW main contacts 3NO auxiliary contacts 1NC connection screw connection type AEG LS4K 01A type GE CL00A 301 H 85mm		

1

			
Part No.	380262	Ref. No.	25130026
description	power contactor resistive load 32A 230VAC (AC3/400V) 17A/7.5kW main contacts 3NO auxiliary contacts 1NC connection screw connection type AEG LS7K01A type GE CL02A 301 H 85mm		



1

Part No.	380261	Ref. No.	25130025
description	power contactor resistive load 32A 230VAC (AC3/400V) 17A/7.5kW main contacts 3NO auxiliary contacts 1NO connection screw connection type AEG LS7K 10A type GE CL02A 310		

LOVATO

power contactors



1

Part No.	380083	Ref. No.	25130037
description	power contactor resistive load 25A 230VAC (AC3/400V) 9A/4.2kW main contacts 3NO auxiliary contacts 1NC connection screw connection type BF0901A230		



1

Part No.	380717	Ref. No.	25130038
description	power contactor resistive load 32A 230VAC (AC3/400V) 18A/7.5kW main contacts 3NO auxiliary contacts 1NC connection screw connection type BF1801A230		

TELEMECANIQUE (Schneider Electric)

power contactors



1

Part No.	380820	Ref. No.	00006280
description	power contactor resistive load 25A 230VAC (AC3/400V) 9A/4kW main contacts 3NO auxiliary contacts 1NO/1NC connection screw connection type LC1D0900M7		



1

Part No.	380617	Ref. No.	00060670
description	power contactor resistive load 25A 24VAC (AC3/400V) 9A/4kW main contacts 3NO auxiliary contacts 1NO/1NC connection screw connection type LC1D09B7		



1

Part No.	380976	Ref. No.	00006270
description	power contactor resistive load 32A 230VAC (AC3/400V) 18A/7.5kW main contacts 3NO auxiliary contacts 1NO/1NC connection screw connection		

auxiliary contacts



1

Part No.	380821	Ref. No.	00006270 (old version)
description	auxiliary contact contacts 1NO/1NC AC15 10A connection screw type LA1DN11		



relays





power relays

with DIN rail mounting

lateral



1

Part No.	380629	Ref. No.	25240004
description	power relays FINDER 24VAC 16A 3CO connection male faston 4.8mm DIN rail manuf. no. 60.33.8.024.0008		
accessories for	380629		
	Part No.	380703	Ref. No. —
	adapter for flange mounting suitable for Finder relay 62 series.		
	Part No.	380811	Ref. No. —
	adapter with bracket mounting suitable for Finder relay 62 series.		
	Part No.	380954	Ref. No. —
	adapter hole distance 54mm bracket mounting suitable for Finder relay 62 series. L 41mm W 39mm H 49mm		
	Part No.	381003	Ref. No. —
	adapter for DIN rail mounting suitable for Finder relay 62 series.		
	Part No.	381039	Ref. No. —
	adapter for DIN rail mounting suitable for Finder relay 62 series.		

with bracket mounting



1

Part No.	380626	Ref. No.	25130101 25130102
description	power relays FINDER 230VAC 10A 2CO connection male faston 4.8mm bracket mounting manuf. no. 62.62.8.230.0000		



1

Part No.	380139	Ref. No.	25130100
description	power relays FINDER 230VAC 16A 2CO connection F6.3 bracket mounting dimensions 68x38.2x35.8mm manuf. no. 62.82.8.230.0000		

electronic controllers

EVCO - EVERY CONTROL

universal controllers

built-in version



1

Part No.	378270	Ref. No.	22192001
description	electronic controller EVERY CONTROL mounting measurements 71x29mm built-in depth 59mm 12/24V voltage AC/DC PTC relay outputs 1 relay with probe protection IP65 -50 up to +150°C display 4 digits cable length 1430mm 16 type EVK411		



1

Part No.	378280	Ref. No.	22192002 22192005+22192006
description	electronic controller EVERY CONTROL mounting measurements 71x29mm built-in depth 59mm 12V voltage AC/DC PTC with probe protection IP65 -50 up to +150°C display 4 digits cable length 1430mm probe ø 6mm 16 type EVK411		

probes

universal probes

temperature probes



1

Part No.	379142	Ref. No.	22192003
description	temperature probe PTC 1kOhm cable PVC probe -50 up to +150°C cable -10 up to 100°C probe ø6x30mm cable length 1.5m without screw connection 2-wire		



1 electric components

producer-specific probes

probes

1 			
Part No.	378343	Ref. No.	25192400
description	temperature probe NTC 10kOhm cable silicone probe -40 up to +110°C cable -50 up to +180°C connection 2-wire thread probe ø7x30mm cable length 1m		

electronics

PCBs

1 			
Part No.	403775	Ref. No.	25192030
description	control PCB warewashing D35/36/45/46/47 L 170mm W 28mm connection coded plug suitable for ELFRAMO		

1 			
Part No.	403163	Ref. No.	25192040
description	PCB dishwasher C34/C44/C66 230V 50/60A		

1 			
Part No.	402990	Ref. No.	25192020
description	PCB dishwasher D35/40		

keypads

control panel

1 			
Part No.	109182	Ref. No.	00038675
description	control panel fryer GW ELT/GWD ELT W 223mm H 70mm D 20mm		

1 			
Part No.	403262	Ref. No.	00222433
description	control panel warewashing BE35 W 178mm H 48mm D 58mm suitable for ELFRAMO		

solenoid valves

solenoid valves (water)

ELBI			
1 			
Part No.	370257	Ref. No.	23120003
description	solenoid valve triple straight 230VAC inlet 3/4" outlet 11.5mm t.max. 90°C ELBI plastic output B 2.5l/min flow regulating valve outlet B orange		



































TP				
1 				
Part No.	370021	Ref. No.	00003120 23120001	
description	solenoid valve double straight 230VAC inlet 3/4" outlet 11.5mm DN10 TP flow regulating valve inlet white			
spare parts for	370021			
	Part No.	371013	Ref. No.	—
	solenoid coil TP 230VAC 50/60Hz			
accessories for	370021			
	Part No.	371220	Ref. No.	—
	reducer TP flow rate 3l/min red tolerance ±15%			
	Part No.	371221	Ref. No.	—
	reducer TP flow rate 5.5l/min yellow tolerance ±15%			
	Part No.	371222	Ref. No.	—
	reducer TP flow rate 6l/min grey tolerance ±15%			
	Part No.	371223	Ref. No.	—
	reducer TP flow rate 10l/min white tolerance ±15%			
	Part No.	371224	Ref. No.	—
	reducer TP flow rate 12l/min bronze tolerance ±15%			
	Part No.	371225	Ref. No.	—
	reducer TP flow rate 16l/min light brown tolerance ±15%			
	Part No.	371226	Ref. No.	—
	reducer TP flow rate 20l/min red tolerance ±15%			
	Part No.	371230	Ref. No.	—
	reducer TP flow rate 0.25l/min red tolerance ±25%			
	Part No.	371231	Ref. No.	—
	reducer TP flow rate 0.35l/min violet tolerance ±25%			

Table continues overleaf



accessories for		370021		
Part No.	Ref. No.	Ref. No.	Ref. No.	—
	371232	371232	371232	—
reducer TP flow rate 0.5l/min orange tolerance $\pm 25\%$				
	371233	371233	371233	—
reducer TP flow rate 0.8l/min white tolerance $\pm 25\%$				
	371234	371234	371234	—
reducer TP flow rate 1l/min light blue tolerance $\pm 25\%$				
	371235	371235	371235	—
reducer TP flow rate 1.2l/min brown tolerance $\pm 25\%$				
	371236	371236	371236	—
reducer TP flow rate 1.5l/min light brown tolerance $\pm 25\%$				
	371237	371237	371237	—
reducer TP flow rate 2.5l/min yellow tolerance $\pm 25\%$				
	371238	371238	371238	—
reducer TP flow rate 3.4l/min dark green tolerance $\pm 25\%$				
	371239	371239	371239	—
reducer TP flow rate 5l/min black tolerance $\pm 25\%$				
	371240	371240	371240	—
reducer TP flow rate 8l/min blue tolerance $\pm 20\%$				

			
1			
Part No.	370111	Ref. No.	00003090 23120002
description	solenoid valve double straight 24VAC inlet 3/4" outlet 11.5mm DN10 TP		
spare parts for	370111		
	Part No.	371035	Ref. No. —
solenoid coil 24VAC			
accessories for	370111		
	Part No.	371220	Ref. No. —
reducer TP flow rate 3l/min red tolerance $\pm 15\%$			
	Part No.	371221	Ref. No. —
reducer TP flow rate 5.5l/min yellow tolerance $\pm 15\%$			
	Part No.	371222	Ref. No. —
reducer TP flow rate 6l/min grey tolerance $\pm 15\%$			
	Part No.	371223	Ref. No. —
reducer TP flow rate 10l/min white tolerance $\pm 15\%$			
	Part No.	371224	Ref. No. —
reducer TP flow rate 12l/min bronze tolerance $\pm 15\%$			

accessories for		370111		
Part No.	Ref. No.	Ref. No.	Ref. No.	—
	371225	371225	371225	—
reducer TP flow rate 16l/min light brown tolerance $\pm 15\%$				
	371226	371226	371226	—
reducer TP flow rate 20l/min red tolerance $\pm 15\%$				
	371230	371230	371230	—
reducer TP flow rate 0.25l/min red tolerance $\pm 25\%$				
	371231	371231	371231	—
reducer TP flow rate 0.35l/min violet tolerance $\pm 25\%$				
	371232	371232	371232	—
reducer TP flow rate 0.5l/min orange tolerance $\pm 25\%$				
	371233	371233	371233	—
reducer TP flow rate 0.8l/min white tolerance $\pm 25\%$				
	371234	371234	371234	—
reducer TP flow rate 1l/min light blue tolerance $\pm 25\%$				
	371235	371235	371235	—
reducer TP flow rate 1.2l/min brown tolerance $\pm 25\%$				
	371236	371236	371236	—
reducer TP flow rate 1.5l/min light brown tolerance $\pm 25\%$				
	371237	371237	371237	—
reducer TP flow rate 2.5l/min yellow tolerance $\pm 25\%$				
	371238	371238	371238	—
reducer TP flow rate 3.4l/min dark green tolerance $\pm 25\%$				
	371239	371239	371239	—
reducer TP flow rate 5l/min black tolerance $\pm 25\%$				
	371240	371240	371240	—
reducer TP flow rate 8l/min blue tolerance $\pm 20\%$				





















			
1			
Part No.	370017	Ref. No.	23120021
description	solenoid valve single straight 230VAC inlet 3/4" outlet 11.5mm DN10 TP p max 10bar		
spare parts for	370017		
	Part No.	371013	Ref. No. —
solenoid coil TP 230VAC 50/60Hz			
accessories for	370017		
	Part No.	371220	Ref. No. —
reducer TP flow rate 3l/min red tolerance $\pm 15\%$			

Table continues overleaf



accessories for		370017		
Part No.		371221	Ref. No.	—
	reducer TP flow rate 5.5l/min yellow tolerance ±15%			
	reducer TP flow rate 6l/min grey tolerance ±15%			
	reducer TP flow rate 10l/min white tolerance ±15%			
	reducer TP flow rate 12l/min bronze tolerance ±15%			
	reducer TP flow rate 16l/min light brown tolerance ±15%			
	reducer TP flow rate 20l/min red tolerance ±15%			
	reducer TP flow rate 0.25l/min red tolerance ±25%			
	reducer TP flow rate 0.35l/min violet tolerance ±25%			
	reducer TP flow rate 0.5l/min orange tolerance ±25%			
	reducer TP flow rate 0.8l/min white tolerance ±25%			
	reducer TP flow rate 1l/min light blue tolerance ±25%			
	reducer TP flow rate 1.2l/min brown tolerance ±25%			
	reducer TP flow rate 1.5l/min light brown tolerance ±25%			
	reducer TP flow rate 2.5l/min yellow tolerance ±25%			
	reducer TP flow rate 3.4l/min dark green tolerance ±25%			
	reducer TP flow rate 5l/min black tolerance ±25%			
	reducer TP flow rate 8l/min blue tolerance ±20%			

metal			
SIRAI			
2-way			
L140-B series			
			
1			
Part No.	370239	Ref. No.	00003130 23140006
description	solenoid valve 2-ways 230VAC connection 1/2" L 41mm DN 10mm slide-on receptacle compact -10 up to +90°C SIRAI type series L140-B coil type Z610A membranes NBR (water) p max 12bar p min 0.35bar		
spare parts for	370239		
	Part No.	371085	Ref. No. —
solenoid coil 230VAC 4VA SIRAI coil type ZB10A seat ø 10mm 50/60Hz			
	Part No.	371163	Ref. No. —
membrane connection 1/2" series L140-B membrane type NBR (water)			
accessories for	370239		
	Part No.	371091	Ref. No. —
power socket plug type DIN 43650B cable lengthmm small			

			
1			
Part No.	370472	Ref. No.	23140004
description	solenoid valve 2-ways 24VAC inlet 1/2" connection 1/2" L 41mm DN 10mm -10 up to +90°C SIRAI coil type Z610A membranes NBR (water) p max 12bar p min 0.35bar 24V voltage AC		

L180-B series			
			
1			
Part No.	370329	Ref. No.	00005692 23140003
description	solenoid valve 2-ways 24VAC inlet 1/2" outlet 1/2" connection 1/2" L 66mm DN 13.5mm slide-on receptacle compact -10 up to +90°C SIRAI type series L180-B coil type Z610A membranes NBR (water) p max 12bar p min 0.35bar		
spare parts for	370329		
	Part No.	371070	Ref. No. 00005661 23160001
solenoid coil 24VAC 10VA SIRAI coil type Z610A seat ø 10mm			
	Part No.	371171	Ref. No. —
membrane series L180-B membrane type NBR (water)			

Table continues overleaf



accessories for 370329			
	Part No.	371091	Ref. No. —
power socket plug type DIN 43650B cable lengthmm small			



Part No.	370252	Ref. No.	00005680 23150002
-----------------	--------	-----------------	----------------------

description solenoid valve 2-ways 24VAC inlet 3/4" outlet 3/4" L 79mm DN 18mm slide-on receptacle compact -10 up to +90°C SIRAI type series L180-B coil type Z610A membranes NBR (water) p max 12bar p min 0.35bar

spare parts for 370252

	Part No.	371070	Ref. No.	00005661 23160001
solenoid coil 24VAC 10VA SIRAI coil type Z610A seat ø 10mm				

	Part No.	371172	Ref. No.	—
membrane connection 3/4" series L180-B membrane type NBR (water)				

accessories for 370252

	Part No.	371091	Ref. No.	—
power socket plug type DIN 43650B cable lengthmm small				

solenoid valves steam (water)

2-way

L153-D series

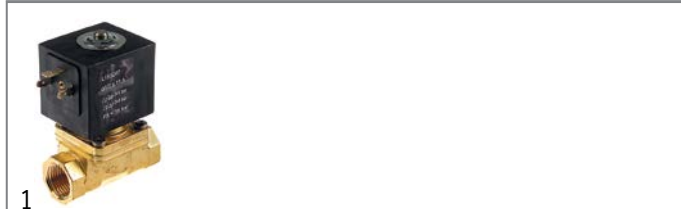

Part No.	370264	Ref. No.	23150003
-----------------	--------	-----------------	----------

description solenoid valve 2-ways 230VAC inlet 1/2" outlet 1/2" connection 1/2" L 66mm DN 11.5mm slide-on receptacle DIN -10 up to 140°C SIRAI type series L153-D coil type Z134A membranes EPDM (steam/water) p max 8bar p min 0.1bar

spare parts for 370264

	Part No.	371077	Ref. No.	—
solenoid coil 230VAC 24VA SIRAI coil type Z110A/Z114A/Z134A seat ø 14mm				

	Part No.	371167	Ref. No.	—
membrane connection 1/2" series L153-D membrane type EPDM				

accessories for 370264

	Part No.	371090	Ref. No.	—
power socket plug type DIN 43650A screw				



Part No.	370325	Ref. No.	00005660 23150001
-----------------	--------	-----------------	----------------------

description solenoid valve 2-ways 24VAC inlet 3/4" outlet 3/4" connection 3/4" L 79mm DN 17mm slide-on receptacle DIN -10 up to 140°C SIRAI type series L153-D coil type Z134A membranes EPDM (steam/water) p max 8bar p min 0.1bar 50Hz

spare parts and accessories

solenoid coils



Part No.	371070	Ref. No.	00005661 23160001
-----------------	--------	-----------------	----------------------

description solenoid coil 24VAC 10VA SIRAI coil type Z610A seat ø 10mm

accessories for 371070

	Part No.	371091	Ref. No.	—
power socket plug type DIN 43650B cable lengthmm small				

solenoid valves (various)

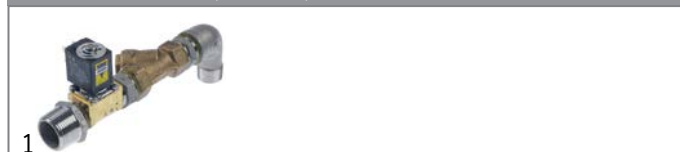

Part No.	370738	Ref. No.	00065310
-----------------	--------	-----------------	----------

description solenoid valve 230VAC inlet 3/4" ET outlet 1" ET L 225mm with in-line particle filter SIRAI coil type Z610A 230V brass warewashing voltage AC

pressure switches

for warewashing

ø 58mm with male faston 6.3mm

with connection horizontal

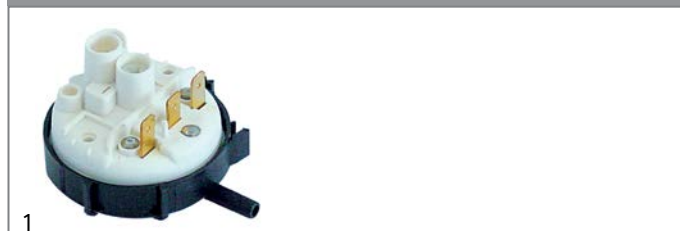

Part No.	541314	Ref. No.	27100002
-----------------	--------	-----------------	----------

description pressure control pressure range 46/26mbar connection 6mm ø 58mm pressure connection horizontal warewashing pressure connection ø 6mm



			
1			
Part No.	541006	Ref. No.	27100001
description	pressure control pressure range 60/20mbar connection 6mm ø 58mm pressure connection horizontal warewashing pressure connection ø 6mm		

			
1			
Part No.	541019	Ref. No.	00005960
description	pressure control pressure range 70/30mbar connection 6mm ø 58mm pressure connection horizontal warewashing pressure connection ø 6mm		

electrodes

			
1			
Part No.	403264	Ref. No.	00013897
description	level electrode total length 125mm angled ø 4mm		

			
1			
Part No.	403263	Ref. No.	00014133
description	level electrode total length 75mm angled ø 4mm		

pumps

wash and rinse pumps

FIR

pumps



1

Part No.	500927	Ref. No.	00002501
description	pump inlet ø 53mm outlet ø 44mm type 0213.1600 230V 50/60Hz 1 phase 1kW 1.36HP L 290mm rotation direction right capacitor 12.5µF FIR		
spare parts for	500927		
	Part No.	365014	Ref. No. 00002630
	operating capacitor capacity 12.5µF 450V tolerance 5%Hz ambient temperature max. -25 to +85°C ø 35mm L 70mm M8 plastic connection male faston 6.3mm 45S.C3DS.12.5 protection		
	Part No.	509010	Ref. No. 00002860
	impellor ø 105mm H 20mm M10L rotation direction right blades 4		
	Part No.	510693	Ref. No. 00003000 06150001 300
	mechanical shaft seal for shaft ø 12mm slide ring ext. ø 24mm slide ring H 15.5mm slide ring int. ø 11mm counter ring mounting ø 24mm height counter ring 8mm counter ring int. ø 13.5mm		
	Part No.	521543	Ref. No. 00002700
	pump cover ELFRAMO inlet ø 53mm outlet ø 44mm turn direction right ø 160mm ID ø 136mm inner height 34mm		
	Part No.	521717	Ref. No. 00002900 06140008 06140140 290
	O-ring EPDM thickness 1.78mm ID ø 120.37mm Qty 1 pcs		



Part No.	500098	Ref. No.	00002520
description	pump inlet \varnothing 62mm outlet \varnothing 49mm type B215.2500 230/400V 50/60Hz 3 phase 1.5kW 2HP L 332mm rotation direction right FIR		
spare parts for	500098		
	Part No.	510693	Ref. No. 00003000 06150001 300
	mechanical shaft seal for shaft \varnothing 12mm slide ringext. \varnothing 24mm slide ring H 15.5mm slide ring int. \varnothing 11mm counter ring mounting \varnothing 24mm height counter ring 8mm counter ring int. \varnothing 13.5mm		
	Part No.	511148	Ref. No. 00002870 287
	impellor \varnothing 118mm H 20mm M10L		
	Part No.	521544	Ref. No. 00002710
	pump cover inlet \varnothing 63mm outlet \varnothing 50mm turn direction right \varnothing 180mm ID \varnothing 165mm inner height 42mm		
	Part No.	521718	Ref. No. 00002910 06140010
	O-ring EPDM thickness 3.53mm ID \varnothing 164.7mm Qty 1 pcs		



Part No.	499051	Ref. No.	00002513
description	pump inlet \varnothing 62mm outlet \varnothing 50mm type B214 230V 50/60Hz 1 phase 1kW rotation direction right capacitor 12.5 μ F FIR		
spare parts for	499051		
	Part No.	365014	Ref. No. 00002630
	operating capacitor capacity 12.5 μ F 450V tolerance 5%Hz ambient temperature max. -25 to +85°C \varnothing 35mm L 70mm M8 plastic connection male faston 6.3mm 45S.C3DS.12.5 protection		
	Part No.	509010	Ref. No. 00002860
	impellor \varnothing 105mm H 20mm M10L rotation direction right blades 4		

spare parts for	499051		
	Part No.	510693	Ref. No. 00003000 06150001 300
	mechanical shaft seal for shaft \varnothing 12mm slide ringext. \varnothing 24mm slide ring H 15.5mm slide ring int. \varnothing 11mm counter ring mounting \varnothing 24mm height counter ring 8mm counter ring int. \varnothing 13.5mm		
	Part No.	517174	Ref. No. —
	nut thread M8 H 6.5mm WS 13 SS DIN/ISO DIN 934 / ISO 4032/8673 Qty 1 pcs		
	Part No.	521544	Ref. No. 00002710
	pump cover inlet \varnothing 63mm outlet \varnothing 50mm turn direction right \varnothing 180mm ID \varnothing 165mm inner height 42mm		
	Part No.	521718	Ref. No. 00002910 06140010
	O-ring EPDM thickness 3.53mm ID \varnothing 164.7mm Qty 1 pcs		
	Part No.	560312	Ref. No. —
	plain washer ID \varnothing 10.5mm ED \varnothing 20mm thickness 2mm SS Qty 1 pcs DIN 125A for thread M10		







INSERT STAR

pumps

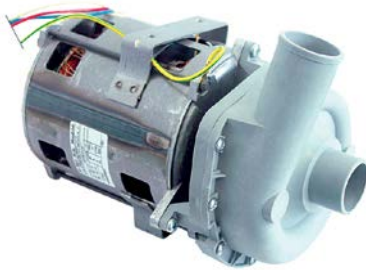

Part No.	499270	Ref. No.	20160040
description	pump inlet \varnothing 38mm outlet \varnothing 38mm type 2/102FA15 220/240V 50/60Hz 1 phase 0.26kW L 200mm rotation direction right INSERT-STAR		
spare parts for	499270		
	Part No.	504578	Ref. No. —
	O-ring EPDM thickness 3.53mm ID \varnothing 94.84mm Qty 1 pcs		
	Part No.	510693	Ref. No. 00003000 06150001 300
	mechanical shaft seal for shaft \varnothing 12mm slide ringext. \varnothing 24mm slide ring H 15.5mm slide ring int. \varnothing 11mm counter ring mounting \varnothing 24mm height counter ring 8mm counter ring int. \varnothing 13.5mm		
	Part No.	650239	Ref. No. —
	impellor \varnothing 75mm H 27mm pump type 2/102FA15 shaft intake \varnothing 8mm rotation direction right thread M8L suitable for INSERTSTAR blades 6		
accessories for	499270		
	Part No.	365093	Ref. No. —
	operating capacitor capacity 6 μ F 400V tolerance 5% 50/60Hz ambient temperature max. -25 to +85°C \varnothing 31.5mm L 55mm M8 plastic connection male faston 6.3mm protection		



			
1			
Part No.	500320	Ref. No.	20160042
description	pump inlet \varnothing 38mm outlet \varnothing 38mm type 2/123/FA30 230V 50Hz 1 phase 0.59kW 0.8HP L 235mm rotation direction right capacitor 10 μ F INSERTSTAR		
spare parts for	500320		
	Part No.	510693	Ref. No. 00003000 06150001 300
	mechanical shaft seal for shaft \varnothing 12mm slide ring ext. \varnothing 24mm slide ring H 15.5mm slide ring int. \varnothing 11mm counter ring mounting \varnothing 24mm height counter ring 8mm counter ring int. \varnothing 13.5mm		
	Part No.	521000	Ref. No. —
	pump cover FAGOR inlet \varnothing 38mm outlet \varnothing 38mm		
	Part No.	521255	Ref. No. —
	impellor \varnothing 88mm H 33mm M8L pump type 2/123/FA30 shaft \varnothing 12mm		
	Part No.	532491	Ref. No. —
	O-ring EPDM thickness 3.53mm ID \varnothing 120.2mm Qty 1 pcs		
accessories for	500320		
	Part No.	365015	Ref. No. —
	operating capacitor capacity 10 μ F 400V tolerance 5%Hz ambient temperature max. -25 to +85°C \varnothing 35.5mm L 59mm M8 plastic connection male faston 6.3mm protection		
	Part No.	551227	Ref. No. —
	female faston size 6.3x0.8mm 1.0-2.5mm ² straight CuZn gal Sn t.max. 110°C Qty 10 pcs		

LAFERT

pumps

			
1			
Part No.	500088	Ref. No.	00002510 00071800
description	pump inlet \varnothing 62mm outlet \varnothing 50mm type AMEE 71Z AA2 230/400V 50/60Hz 3 phase 0.75kW 1HP L 310mm rotation direction right Lafert		
spare parts for	500088		
	Part No.	509010	Ref. No. 00002860
	impellor \varnothing 105mm H 20mm M10L rotation direction right blades 4		

spare parts for	500088		
	Part No.	510693	Ref. No. 00003000 06150001 300
	mechanical shaft seal for shaft \varnothing 12mm slide ring ext. \varnothing 24mm slide ring H 15.5mm slide ring int. \varnothing 11mm counter ring mounting \varnothing 24mm height counter ring 8mm counter ring int. \varnothing 13.5mm		
	Part No.	511132	Ref. No. 00002770
	pump cover bottom part		
	Part No.	517174	Ref. No. —
	nut thread M8 H 6.5mm WS 13 SS DIN/ISO DIN 934 / ISO 4032/8673 Qty 1 pcs		
	Part No.	521544	Ref. No. 00002710
	pump cover inlet \varnothing 63mm outlet \varnothing 50mm turn direction right \varnothing 180mm ID \varnothing 165mm inner height 42mm		
	Part No.	521718	Ref. No. 00002910 06140010
	O-ring EPDM thickness 3.53mm ID \varnothing 164.7mm Qty 1 pcs		
	Part No.	560312	Ref. No. —
	plain washer ID \varnothing 10.5mm ED \varnothing 20mm thickness 2mm SS Qty 1 pcs DIN 125A for thread M10		

			
1			
Part No.	500097	Ref. No.	00002523
description	pump inlet \varnothing 62mm outlet \varnothing 50mm type AMM80Z 230V 50Hz 1 phase 1.5kW 2HP L 320mm rotation direction right capacitor 25 μ F Lafert		
spare parts for	500097		
	Part No.	511148	Ref. No. 00002870 287
	impellor \varnothing 118mm H 20mm M10L		
	Part No.	521544	Ref. No. 00002710
	pump cover inlet \varnothing 63mm outlet \varnothing 50mm turn direction right \varnothing 180mm ID \varnothing 165mm inner height 42mm		

LGB



1

Part No.	499204	Ref. No.	20160048
description	pump inlet ø 28mm outlet ø 26mm type ZF119SX 230V 50Hz 1 phase 0.15kW 0.2HP L 195mm rotation direction right capacitor 5µF auxiliary pressure connection 12mm LGB		
spare parts for	499204		
	Part No.	365017	Ref. No. —
	operating capacitor capacity 5µF 450V tolerance 5% 50/60Hz ambient temperature max. -25 to +85°C ø 28mm L 54mm M8 plastic connection male faston 6.3mm 16.10.08 protection		
	Part No.	510703	Ref. No. 06150006
	mechanical shaft seal for shaft ø 13mm slide ring H 13mm height counter ring 5.5mm ED ø 26mm		
	Part No.	521057	Ref. No. 20161002
	pump cover LGB inlet ø 28mm outlet ø 26mm auxiliary pressure connection 12mm supporting pressure open turn direction right ø 102mm ID ø 77mm inner height 31mm		
	Part No.	521114	Ref. No. —
	impellor ø 48mm H 17mm pump type ZF119SX shaft ø 13mm shaft length 12mm		
	Part No.	528800	Ref. No. —
	O-ring EPDM thickness 2.62mm ID ø 75.87mm Qty 1 pcs		







1

Part No.	501556	Ref. No.	20160027
description	pump inlet ø 28mm outlet ø 26mm type ZF119SX 230V 50Hz 1 phase 0.2kW 0.27HP L 186mm rotation direction right capacitor 5µF LGB		
spare parts for	501556		
	Part No.	521057	Ref. No. 20161002
	pump cover LGB inlet ø 28mm outlet ø 26mm auxiliary pressure connection 12mm supporting pressure open turn direction right ø 102mm ID ø 77mm inner height 31mm		



1

Part No.	500094	Ref. No.	20160025
description	pump inlet ø 28mm outlet ø 26mm type ZF131SX 230V 50Hz 1 phase 0.2kW 0.15HP L 195mm rotation direction left capacitor 6.3µF LGB		
spare parts for	500094		
	Part No.	365012	Ref. No. —
	operating capacitor capacity 6.3µF 450V tolerance 5% 50Hz ambient temperature max. -25 to +85°C ø 30mm L 61mm M8 plastic connection male faston 6.3mm protection		
	Part No.	502266	Ref. No. 20161000
	pump cover inlet ø 28mm outlet ø 26mm		
	Part No.	510703	Ref. No. 06150006
	mechanical shaft seal for shaft ø 13mm slide ring H 13mm height counter ring 5.5mm ED ø 26mm		
	Part No.	521085	Ref. No. —
	impellor ø 72mm H 17mm thread M7L shaft ø 13mm shaft length 12mm blades 3		
	Part No.	528800	Ref. No. —
	O-ring EPDM thickness 2.62mm ID ø 75.87mm Qty 1 pcs		



1





Part No.	500539	Ref. No.	00202481
description	pump inlet ø 28mm outlet ø 26mm type ZF170SX 230V 50Hz 1 phase 0.32kW 0.44HP L 200mm rotation direction right capacitor 8µF LGB		
spare parts for	500539		
	Part No.	509004	Ref. No. 00210036
	impellor ø 71mm H 16mm M7L rotation direction right shaft ø 13mm shaft length 13mm blades 8		
	Part No.	510703	Ref. No. 06150006
	mechanical shaft seal for shaft ø 13mm slide ring H 13mm height counter ring 5.5mm ED ø 26mm		







Table continues overleaf



spare parts for 500539			
	Part No.	521057	Ref. No. 20161002
pump cover LGB inlet ø 28mm outlet ø 26mm auxiliary pressure connection 12mm supporting pressure open turn direction right ø 102mm ID ø 77mm inner height 31mm			
	Part No.	528800	Ref. No. —
O-ring EPDM thickness 2.62mm ID ø 75.87mm Qty 1 pcs			
accessories for 500539			
	Part No.	365013	Ref. No. —
operating capacitor capacity 8µF 400V tolerance 5%Hz ambient temperature max. -25 to +85°C ø 31.5mm L 55mm M8 plastic connection male faston 6.3mm protection			







1

Part No.	500092	Ref. No.	00202480
description	pump inlet ø 50mm outlet ø 44mm type W300SX 230V 50Hz 1 phase 0.3kW 0.5HP L 170mm rotation direction right capacitor 10µF LGB		
spare parts for 500092			
	Part No.	365015	Ref. No. —
operating capacitor capacity 10µF 400V tolerance 5%Hz ambient temperature max. -25 to +85°C ø 35.5mm L 59mm M8 plastic connection male faston 6.3mm protection			
	Part No.	510554	Ref. No. 00002900 06140008 06140140
O-ring EPDM thickness 2mm ID ø 120mm Qty 1 pcs			
	Part No.	510607	Ref. No. —
impeller ø 85mm H 29mm shaft intake ø 9x8mm rotation direction right blades 6			
	Part No.	510693	Ref. No. 00003000 06150001 300
mechanical shaft seal for shaft ø 12mm slide ring ext. ø 24mm slide ring H 15.5mm slide ring int. ø 11mm counter ring mounting ø 24mm height counter ring 8mm counter ring int. ø 13.5mm			
	Part No.	511178	Ref. No. 00202460
pump cover bottom part			
	Part No.	521564	Ref. No. 00210028
pump cover			



1

Part No.	500093	Ref. No.	00202486
description	pump inlet ø 50mm outlet ø 44mm type W500SX 230V 50Hz 1 phase 0.5kW 0.7HP L 200mm rotation direction right capacitor 16µF LGB		
spare parts for 500093			
	Part No.	365021	Ref. No. 24100004
operating capacitor capacity 16µF 425V tolerance 5% 50/60Hz ambient temperature max. -25 to +85°C ø 35mm L 73mm single M8 plastic connection male faston 6.3mm 416.10.99 protection			
	Part No.	510607	Ref. No. —
impeller ø 85mm H 29mm shaft intake ø 9x8mm rotation direction right blades 6			
	Part No.	510693	Ref. No. 00003000 06150001 300
mechanical shaft seal for shaft ø 12mm slide ring ext. ø 24mm slide ring H 15.5mm slide ring int. ø 11mm counter ring mounting ø 24mm height counter ring 8mm counter ring int. ø 13.5mm			
	Part No.	521564	Ref. No. 00210028
pump cover			
	Part No.	521717	Ref. No. 00002900 06140008 06140140 290
O-ring EPDM thickness 1.78mm ID ø 120.37mm Qty 1 pcs			

booster pumps I



1

Part No.	500540	Ref. No.	20160001
description	pump inlet ø 1" IT outlet ø 1" IT type PKM60 230V 50Hz 1 phase 0.37kW PEDRELLO 0.5HP		
accessories for 500540			
	Part No.	365015	Ref. No. —
operating capacitor capacity 10µF 400V tolerance 5%Hz ambient temperature max. -25 to +85°C ø 35.5mm L 59mm M8 plastic connection male faston 6.3mm protection			





1

Part No.	499067	Ref. No.	20160003
description	pump inlet ø 1" IT outlet ø 1" IT type PKM60 230V 60Hz 1 phase 0.37kW 0.5HP L 247mm rotation direction left capacitor 10µF PEDRELLLO		



1

Part No.	500395	Ref. No.	20160011 20160016
description	pump inlet ø 3/8" IT outlet ø 3/8" IT type PS45DX 230V 50Hz 0.35kW capacitor 8µF LGB		
spare parts for	500395		
	Part No.	365013	Ref. No. —
	operating capacitor capacity 8µF 400V tolerance 5%Hz ambient temperature max. -25 to +85°C ø 31.5mm L 55mm M8 plastic connection male faston 6.3mm protection		
	Part No.	698400	Ref. No. —
	pump cover gasket pump type PS46 thickness 2mm ID ø 66mm Qty 1 pcs		

drain pumps

HANNING



1

Part No.	500082	Ref. No.	00002570
description	drain pump 230V 100W		

PLASET



1

Part No.	500083	Ref. No.	20160014
description	drain pump inlet ø 30mm outlet ø 23mm 220-240V 34W 50Hz PLASET		

miscellaneous



1

Part No.	499001	Ref. No.	20160013
description	drain pump inlet ø 30mm outlet ø 22mm 220V 34W 60Hz PLASET		

condensators & interference suppression filters

operating capacitors

plastic



1

Part No.	365014	Ref. No.	00002630
description	operating capacitor capacity 12.5µF 450V tolerance 5%Hz ambient temperature max. -25 to +85°C ø 35mm L 70mm M8 plastic connection male faston 6.3mm 45S.C3DS.12.5 protection		



1

Part No.	365021	Ref. No.	24100004
description	operating capacitor capacity 16µF 425V tolerance 5% 50/60Hz ambient temperature max. -25 to +85°C ø 35mm L 73mm single M8 plastic connection male faston 6.3mm 416.10.99 protection		

filters

interference suppression filters



1

Part No.	365026	Ref. No.	00002650 24100100
description	interference suppression filter capacity 0.47µF(X2)+2x0.01µF(Y2) 0.68MΩhm		



1

Part No.	365089	Ref. No.	24100102
description	interference suppression filter type X1+100R 250V capacity 0.24µF		



fuses

fine fuses

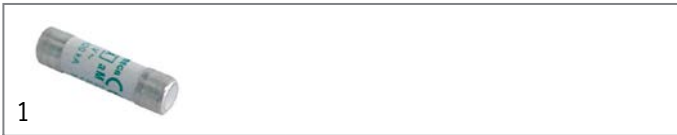

1	Part No.	358041	Ref. No.	00060970
description fine fuse size ø10x38mm 20A slow-acting rated 400V type aM Qty 1 pcs				



1	Part No.	358030	Ref. No.	00060980
description fine fuse size ø10x38mm 32A slow-acting rated 400V type aM Qty 1 pcs				



1	Part No.	358038	Ref. No.	00060960 37130999
description fine fuse size ø10x38mm 10A slow-acting rated 500V type aM Qty 1 pcs				



1	Part No.	358040	Ref. No.	00006261
description fine fuse size ø10x38mm 16A slow-acting rated 500V type aM Qty 1 pcs				

fine fuse holders



1	Part No.	358075	Ref. No.	00006121 37170001
description fuse holder for for fuse ø10x38mm suitable fuse ø10x38mm 1-pole 32A rated 690V for DIN rail 35mm cross section 10mm ² suitable for for fuse ø10x38mm				

electric accessories

cables

ribbon cables

group 1

1	Part No.	403776	Ref. No.	25190105
description ribbon cable 10-pole L 2600mm plug type FC-10P raster size 2.54mm				

terminals

rail-mounted terminals

miscellaneous

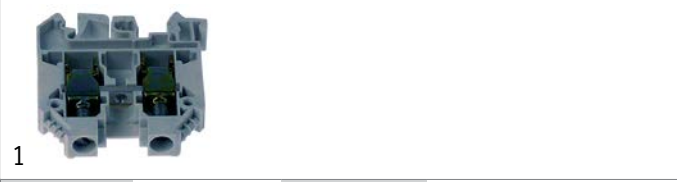

1	Part No.	358505	Ref. No.	00006260
description rail-mounted terminal 6-10mm ² 1-pole				

gas thermostats

SIT

710 Minisit series



1	Part No.	107543	Ref. No.	00034620
description gas thermostat kit SIT type MINISIT 710 t.max. 190°C 110-190°C gas inlet 1/2" IT gas outlet 3/8" IT thermocouple connection M9x1 probe ø 6mm probe L 105mm capillary pipe 1050mm pressure controller no				

spare parts for 107543				
-------------------------------	--	--	--	--

	Part No.	101135	Ref. No.	00038639
description gas thermostat SIT type MINISIT 710 t.max. 190°C 110-190°C gas inlet 1/2" gas outlet 3/8" thermocouple connection M9x1 pilot connection M10x1 probe ø 6mm probe L 102mm capillary pipe 1050mm probe type type A3 pressure controller no pressure regulatormbar gland nut				

	Part No.	390730	Ref. No.	22170003
description safety thermostat switch-off temp. 230°C 1-pole 0.5A probe ø 4mm probe L 125mm capillary pipe 1550mm capillary pipe isolated 1410mm gland nut probe				



Part No.	101135	Ref. No.	00038639
description	gas thermostat SIT type MINISIT 710 t.max. 190°C 110-190°C gas inlet 1/2" gas outlet 3/8" thermocouple connection M9x1 pilot connection M10x1 probe ø 6mm probe L 102mm capillary pipe 1050mm probe type type A3 pressure controller no pressure regulatormbar gland nut		
spare parts for	101135		
	Part No.	101053	Ref. No. —
	magnet unit T1: M9x1 T2: M24x1 L 45mm ø 17mm suitable for Minisit		
	Part No.	102118	Ref. No. —
	probe 110-190°C probe ø 6mm probe L 102mm capillary pipe 1050mm t.max. 190°C fryer probe type type A3 suitable for MINISIT 710		
accessories for	101135		
	Part No.	100809	Ref. No. —
	O-ring EPDM thickness 2mm ID ø 21mm Qty 1 pcs		
	Part No.	100820	Ref. No. —
	gland duct ET M14x1.5 IT M10x0.75 probe ø max. 6.5mm WS 22		
	Part No.	100904	Ref. No. —
	locking screw M10x1 for pipe ø 4mm Qty 1 pcs		
	Part No.	100905	Ref. No. —
	locking screw M10x1 for pipe ø 6mm Qty 1 pcs		
	Part No.	101054	Ref. No. —
	magnet unit T1: M10x1 T2: M24x1 L 45mm ø 17mm suitable for Minisit		
	Part No.	101136	Ref. No. 00032410
	piezoelectric igniter suitable for Minisit with cover cap ømm connection F6.3x0.8		
	Part No.	101137	Ref. No. —
	cover cap without piezoelectric igniter		
	Part No.	101267	Ref. No. —
	reducer IT 3/8" ET 1/2" L 21mm		
	Part No.	101268	Ref. No. —
	gas connection thread 3/8" angled with O-ring MINISIT 710		
	Part No.	101269	Ref. No. —
	gas connection thread 1/2" angled with O-ring MINISIT 710		
	Part No.	101270	Ref. No. —
	screw connection IT 3/8" ET 3/8" L 28mm		
	Part No.	101272	Ref. No. —
	screw connection IT 1/2" ET 3/8" L 57mm		
	Part No.	101273	Ref. No. —
	olive for pipe ø 12mm L 9.5mm brass Qty 1 pcs suitable for universal		

accessories for	101135		
	Part No.	101274	Ref. No. —
	olive for pipe ø 16mm Qty 1 pcs		
	Part No.	101275	Ref. No. —
	union screw thread 1/2" for pipe ø 16mm Qty 1 pcs		
	Part No.	101276	Ref. No. —
	union screw thread 3/8" tube ø 12mm Qty 1 pcs		
	Part No.	110068	Ref. No. 16100003
	knob suitable for Minisit ø 37mm		

Part No.	101434	Ref. No.	00032390
description	gas thermostat without accessories SIT type MINISIT 710 t.max. 190°C 110-190°C gas inlet 1/2" gas outlet 3/8" thermocouple connection M9x1 pilot connection M10x1 probe ø 5mm probe L 102mm capillary pipe 1200mm probe type type G1 pressure controller no pressure regulatormbar gland nut		
spare parts for	101434		
	Part No.	101053	Ref. No. —
	magnet unit T1: M9x1 T2: M24x1 L 45mm ø 17mm suitable for Minisit		
	Part No.	102105	Ref. No. 16100030
	probe 110-200°C probe ø 6mm probe L 102mm capillary pipe 1050mm t.max. 200°C fryer probe type type G1 suitable for MINISIT 710		
accessories for	101434		
	Part No.	100809	Ref. No. —
	O-ring EPDM thickness 2mm ID ø 21mm Qty 1 pcs		
	Part No.	100904	Ref. No. —
	locking screw M10x1 for pipe ø 4mm Qty 1 pcs		
	Part No.	100905	Ref. No. —
	locking screw M10x1 for pipe ø 6mm Qty 1 pcs		
	Part No.	101054	Ref. No. —
	magnet unit T1: M10x1 T2: M24x1 L 45mm ø 17mm suitable for Minisit		
	Part No.	101136	Ref. No. 00032410
	piezoelectric igniter suitable for Minisit with cover cap ømm connection F6.3x0.8		
	Part No.	101137	Ref. No. —
	cover cap without piezoelectric igniter		
	Part No.	101267	Ref. No. —
	reducer IT 3/8" ET 1/2" L 21mm		

Table continues overleaf



accessories for		101434	
Part No.	101268	Ref. No.	—
	gas connection	thread 3/8" angled with O-ring MINISIT 710	
Part No.	101269	Ref. No.	—
	gas connection	thread 1/2" angled with O-ring MINISIT 710	
Part No.	101270	Ref. No.	—
	screw connection	IT 3/8" ET 3/8" L 28mm	
Part No.	101272	Ref. No.	—
	screw connection	IT 1/2" ET 3/8" L 57mm	
Part No.	101273	Ref. No.	—
	olive	for pipe ø 12mm L 9.5mm brass Qty 1 pcs suitable for universal	
Part No.	101274	Ref. No.	—
	olive	for pipe ø 16mm Qty 1 pcs	
Part No.	101275	Ref. No.	—
	union screw	thread 1/2" for pipe ø 16mm Qty 1 pcs	
Part No.	101276	Ref. No.	—
	union screw	thread 3/8" tube ø 12mm Qty 1 pcs	
Part No.	110068	Ref. No.	16100003
	knob	suitable for Minisit ø 37mm	

accessories

probes



Part No.	102105	Ref. No.	16100030
description	probe 110-200°C probe ø 6mm probe L 102mm capillary pipe 1050mm t.max. 200°C fryer probe type type G1 suitable for MINISIT 710		





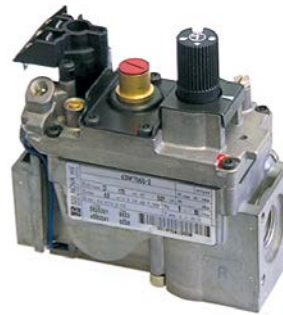

gas valves and ignition boxes

gas control valves

SIT

NOVASIT



Part No.	101187	Ref. No.	16100005
description	gas valve SIT series Novasit 820 0.17VHz gas inlet 1/2" gas outlet 1/2" thermocouple connection M9x1 pilot connection M10x1 ignition pressurembar pressure range 5-50mbar pressure regulator connection blind equiv. no. 0.820.301 supply Operator millivolt		
spare parts for	101187		
	Part No.	101065	Ref. No. —
magnet unit with cable L 44mm D1 ø 30mm D2 ø 20mm suitable for NOVASIT			
accessories for	101187		
	Part No.	100110	Ref. No. —
pilot burner SIT type 190 series 3 flames nozzle ømm gas connectionmm			
	Part No.	101305	Ref. No. —
gas connection straight 1/2" flange 45x45mm ELETTRISIT/V4400/4600/4605 suitable for SIT/HONEYWELL hole distance 36x36mm			
	Part No.	101306	Ref. No. —
gas connection angled flange 45x45mm hole distance 36x36mm 1/2" ELETTRISIT/V4400/4600/4605 screw with O-ring suitable for SIT/HONEYWELL			
	Part No.	101307	Ref. No. —
gas connection straight flange 45x45mm hole distance 36x36mm 3/4" ELETTRISIT/V4400/4600/4605 screw with O-ring suitable for SIT/HONEYWELL			
	Part No.	101308	Ref. No. —
gas connection angled flange 45x45mm hole distance 36x36mm 3/4" ELETTRISIT/V4400/4600/4605 screw with O-ring suitable for SIT/HONEYWELL			
	Part No.	102116	Ref. No. 17100002
thermopile ROBERTSHAW L 900mm probe ø 9mm probe L 57mm 250-750mV screw connection 7/16"			



ignition parts















pilot burners



SIT

100 series



1

Part No.	106906	Ref. No.	33120005
description	pilot burner SIT type 100 series 3 flames nozzle \varnothing 0.2mm gas connection 6mm		
spare parts for	106906		
	Part No.	100245	Ref. No. —
	pilot burner nozzle LPG code 20 bore \varnothing 0.2mm Qty 1 pcs thread M8x0.75		
	Part No.	100855	Ref. No. —
	pilot burner bracket triple		
	Part No.	100885	Ref. No. —
	air mixing sleeve for pilot burner Qty 1 pcs		
	Part No.	100916	Ref. No. —
	compression spring for pilot burner Qty 1 pcs		
	Part No.	100917	Ref. No. —
	gasket for pilot burner Qty 1 pcs aluminium		
	Part No.	100918	Ref. No. —
	screw for pilot burner		
	Part No.	107162	Ref. No. —
	pilot burner cap SIT 3 flames Hmm Lmm Qty 1 pcs		
	Part No.	107701	Ref. No. —
	pilot burner bottom part SIT 100 series nozzle \varnothing 0.2mm		
accessories for	106906		
	Part No.	100245	Ref. No. —
	pilot burner nozzle LPG code 20 bore \varnothing 0.2mm Qty 1 pcs thread M8x0.75		
	Part No.	100246	Ref. No. —
	pilot burner nozzle natural gas bore \varnothing 0.35mm Qty 1 pcs thread M8x0.75		
	Part No.	100904	Ref. No. —
	locking screw M10x1 for pipe \varnothing 4mm Qty 1 pcs		
	Part No.	100905	Ref. No. —
	locking screw M10x1 for pipe \varnothing 6mm Qty 1 pcs		
	Part No.	102110	Ref. No. —
	pilot tube copper pipe \varnothing 4mm thickness 1mm L 3000mm		
	Part No.	102111	Ref. No. —
	pilot tube copper pipe \varnothing 6mm thickness 1mm L 3000mm		

accessories for	106906		
	Part No.	107171	Ref. No. —
	pilot burner nozzle SIT natural/liquid gas bore \varnothing 0.25mm Qty 1 pcs		
	Part No.	107700	Ref. No. —
	pilot burner bottom part SIT 100 series nozzle \varnothing 0.25mm		
	Part No.	107702	Ref. No. —
	pilot burner bottom part SIT 100 series nozzle \varnothing 0.35mm		

accessories

ignition electrodes



1

Part No.	100706	Ref. No.	33110002
description	ignition electrode connection M4 Qty 1 pcs		

160 series



1









Part No.	100049	Ref. No.	00032790
description	pilot burner SIT type 160 series 2 flames nozzle \varnothing mm gas connectionmm		
spare parts for	100049		
	Part No.	100907	Ref. No. 33120009
	screw connection thread M10x1 Qty 1 pcs type SEF 1 \varnothing mm for thermocouple		
accessories for	100049		
	Part No.	100202	Ref. No. —
	pilot burner nozzle natural gas code 41 Qty 1 pcs nozzle \varnothing 0.41mm		
	Part No.	100203	Ref. No. —
	pilot burner nozzle LPG code 25 Qty 1 pcs nozzle \varnothing 0.25mm		
	Part No.	100701	Ref. No. 33110001
	ignition electrode connection M4 Qty 1 pcs		
	Part No.	100869	Ref. No. —
	pilot burner nozzle natural gas code 51 Qty 1 pcs suitable for 160 series nozzle \varnothing 0.51mm		
	Part No.	100906	Ref. No. 33120004
	screw connection thread M10x1 for ignition electrode brass Qty 1 pcs WS 10		
	Part No.	100908	Ref. No. —
	union screw thread M10x1 for pipe \varnothing 4mm Qty 1 pcs		

Table continues overleaf



accessories for		100049		
	Part No.	100909	Ref. No.	—
	union screw thread M10x1 for pipe ø 6mm Qty 1 pcs			
	Part No.	101282	Ref. No.	—
	olive for pipe ø 4mm L 7.4mm Qty 1 pcs			
	Part No.	101287	Ref. No.	—
	olive for pipe ø 6mm Qty 1 pcs			
	Part No.	102110	Ref. No.	—
	pilot tube copper pipe ø 4mm thickness 1mm L 3000mm			
	Part No.	102111	Ref. No.	—
	pilot tube copper pipe ø 6mm thickness 1mm L 3000mm			
	Part No.	107650	Ref. No.	00032680
	pilot burner nozzle SIT LPG code 30 Qty 1 pcs			

190 series



	1			
Part No.	106722	Ref. No.	00038491	
description	pilot burner SIT type 190 series 3 flames natural/liquid gas nozzle 35/51 nozzle ø 0.35/0.51mm gas connection 6mm complete with nozzle			



POLIDORO

pilot burners



	1			
Part No.	104485	Ref. No.	33120030	
description	pilot burner POLIDORO 2 flames natural gas code 29.2 gas connection 6mm			

miscellaneous

	1			
Part No.	106966	Ref. No.	00038531	
description	pilot burner 2 flames natural/liquid gas nozzle ø 0.45mm gas connection 6mm			
spare parts for	106966			
	Part No.	100855	Ref. No.	—
	pilot burner bracket triple			
	Part No.	100885	Ref. No.	—
	air mixing sleeve for pilot burner Qty 1 pcs			

spare parts for		106966		
	Part No.	102742	Ref. No.	—
	pilot burner nozzle LPG code 25 bore ø 0.25mm Qty 1 pcs			
	Part No.	102973	Ref. No.	—
	pilot burner nozzle natural gas bore ø 0.45mm Qty 1 pcs			

electrodes

	1			
Part No.	100701	Ref. No.	33110001	
description	ignition electrode connection M4 Qty 1 pcs			
accessories for	100701			
	Part No.	100906	Ref. No.	33120004
	screw connection thread M10x1 for ignition electrode brass Qty 1 pcs WS 10			

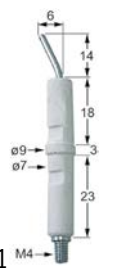
	1			
Part No.	100706	Ref. No.	33110002	
description	ignition electrode connection M4 Qty 1 pcs			

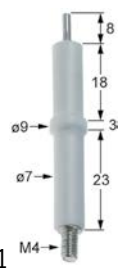
	1			
Part No.	102871	Ref. No.	33110003	
description	ignition electrode D1 ø 7mm D2 ø 9mm connection M4 L1 8mm BL1 18mm BL2 3mm BL3 23mm to clip			





1

Part No.	100906	Ref. No.	33120004
description	screw connection thread M10x1 for ignition electrode brass Qty 1 pcs WS 10		

ignition cables

pre-assembled cables



1

Part No.	100015	Ref. No.	30140002
description	ignition cable cable length 600mm connection $\varnothing 2.4\text{mm}$ / $\varnothing 2.4\text{mm}$		



1

Part No.	100025	Ref. No.	30140001
description	ignition cable cable length 600mm connection $\varnothing 4\text{mm}$ / F6.3mm		

piezoelectric igniters

mounting diameter 22mm



1

Part No.	100005	Ref. No.	33100003
description	piezoelectric igniter body plastic blowing mounting $\varnothing 22\text{mm}$ connection $\varnothing 2.4\text{mm}$ cable lengthmm SIT		

miscellaneous



1

Part No.	nla ¹	Ref. No.	00032460
description	piezoelectric igniter suitable for Minisit connection F6.3x0.8 $\varnothing\text{mm}$		

¹no longer available



1

Part No.	nla ¹	Ref. No.	00032410
description	piezoelectric igniter suitable for Minisit with cover cap $\varnothing\text{mm}$ connection F6.3x0.8		
spare parts for	101136		
	Part No.	Ref. No.	00032460
	piezoelectric igniter suitable for Minisit connection F6.3x0.8 $\varnothing\text{mm}$		

¹no longer available

thermocouples

plug-in thermocouples

plug-in thermocouples with interruption

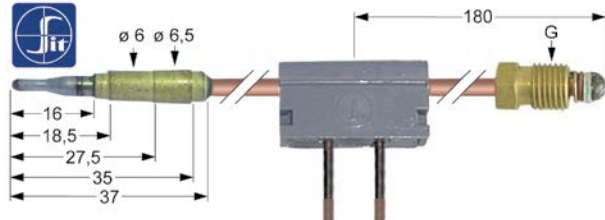

1

Part No.	107234	Ref. No.	17100003
description	thermocouple SIT with interrupter M9x1 L 400mm plug connection $\varnothing 6.0\text{mm}$ soldering connection		

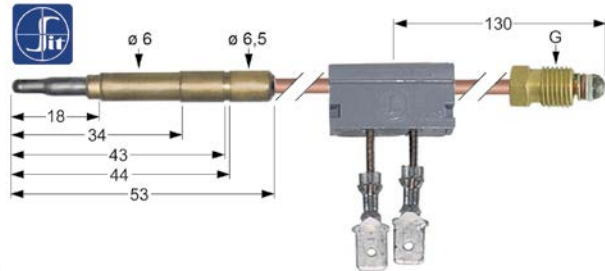

1

Part No.	107177	Ref. No.	00032580 17100001
description	thermocouple SIT with interrupter M9x1 L 600mm plug connection $\varnothing 6.0\text{mm}$ F 6.3mm		

thermopiles

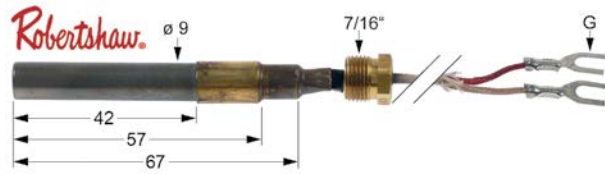

1

Part No.	102116	Ref. No.	17100002
description	thermopile ROBERTSHAW L 900mm probe $\varnothing 9\text{mm}$ probe L 57mm 250-750mV screw connection 7/16"		



gas burners

bar burners

bar burners



1

Part No.	105384	Ref. No.	15100004
-----------------	--------	-----------------	----------

description	bar burner 2 row L 450mm W 240mm ømm H 310mm fryer		
--------------------	--	--	--



1

Part No.	104483	Ref. No.	15100010
-----------------	--------	-----------------	----------

description	bar burner ø 40mm Wmm Hmm L 340mm flange width 50mm flange length 62mm fryer		
--------------------	--	--	--



1

Part No.	105430	Ref. No.	15100008
-----------------	--------	-----------------	----------

description	bar burner ø 40mm Wmm Hmm L 340mm flange width 60mm flange length 76mm fryer		
--------------------	--	--	--

gas nozzles

main nozzles

gas nozzles M10x1



1

Part No.	100067	Ref. No.	18110093 18110121
-----------------	--------	-----------------	----------------------

description	gas injector thread M10x1 WS 12 bore ø 1.1mm G30 gas pressure 30mbar		
--------------------	--	--	--



1

Part No.	107343	Ref. No.	18110111 18110130
-----------------	--------	-----------------	----------------------

description	gas injector thread M10x1 WS 12 bore ø 1.2mm LPG gas pressure 30mbar		
--------------------	--	--	--



1

Part No.	106290	Ref. No.	18110095 18110110
-----------------	--------	-----------------	----------------------

description	gas injector thread M10x1 WS 12 bore ø 1.85mm inner peaked		
--------------------	--	--	--

pilot burner nozzles

pilot burner nozzles POLIDORO



1

Part No.	100000	Ref. No.	18100060
-----------------	--------	-----------------	----------

description	pilot burner nozzle POLIDORO LPG code 22 bore ø 0.22mm Qty 1 pcs		
--------------------	--	--	--



1

Part No.	104486	Ref. No.	18100061
-----------------	--------	-----------------	----------

description	pilot burner nozzle POLIDORO natural gas code 29.2 bore ø 2x0.29mm Qty 1 pcs		
--------------------	--	--	--

pilot burner nozzles SIT

160 series



1

Part No.	107172	Ref. No.	18100094
-----------------	--------	-----------------	----------

description	pilot burner nozzle SIT LPG code 25 Qty 1 pcs		
--------------------	---	--	--



1

Part No.	107650	Ref. No.	00032680
-----------------	--------	-----------------	----------

description	pilot burner nozzle SIT LPG code 30 Qty 1 pcs		
--------------------	---	--	--



1

Part No.	107173	Ref. No.	18100095
-----------------	--------	-----------------	----------

description	pilot burner nozzle SIT natural gas code 35 Qty 1 pcs suitable for 160 series nozzle ø 0.35mm		
--------------------	---	--	--

1

Part No.	107175	Ref. No.	00032690
description	pilot burner nozzle SIT natural gas code 51 Qty 1 pcs suitable for 160 series		

auxiliary gas parts

screw connections

union screws



1

Part No.	100906	Ref. No.	33120004
description	screw connection thread M10x1 for ignition electrode brass Qty 1 pcs WS 10		



1

Part No.	100907	Ref. No.	33120009
description	screw connection thread M10x1 Qty 1 pcs type SEF 1 ømm for thermocouple		

angle pieces



1

Part No.	104484	Ref. No.	12355007
description	angle piece T1: 1/2" ET T2: 1/2" ET		

equipment-specific units

for deep fryers

lids



1

Part No.	695603	Ref. No.	00030660
description	lid suitable for fryer L 305mm W 210mm with handle		



1

Part No.	695606	Ref. No.	00030690
description	lid suitable for fryer L 340mm W 270mm		

basket holders



1

Part No.	970736	Ref. No.	00038567
description	basket support for fryer W 265mm H 220mm suitable for ELFRAMO GW		



miscellaneous



1

Part No.	550268	Ref. No.	00032290
description	cover cap for push-button		

for dishwashers

containers

dosing containers



1

Part No.	511162	Ref. No.	00003730
-----------------	--------	-----------------	----------

description drawer for rinse aid

accessories for 511162



Part No.	511163	Ref. No.	00003731 373A
-----------------	--------	-----------------	------------------

screw for rinse aid container



1

Part No.	361739	Ref. No.	00003740
-----------------	--------	-----------------	----------

description rinse aid container



1

Part No.	511126	Ref. No.	00011060
-----------------	--------	-----------------	----------

description rinse aid container

salt tanks

1

Part No.	511895	Ref. No.	12145002
-----------------	--------	-----------------	----------

description salt tank



1

Part No.	510032	Ref. No.	12145002 12145003
-----------------	--------	-----------------	----------------------

description salt tank without gasket new model

spare parts for 510032

	Part No.	506015	Ref. No.	—
	O-ring EPDM thickness 3.53mm ID ø 39.69mm Qty 1 pcs			
	Part No.	510018	Ref. No.	—
	nut ø 92mm H 10.5mm for salt tank ID ø 64mm			
	Part No.	510071	Ref. No.	—
	flat gasket rubber ED ø 81mm ID ø 68mm thickness 3mm for salt tank Qty 1 pcs			
	Part No.	524177	Ref. No.	—
	lid ø 69mm H 20mm for salt tank ID ø 50mm			



accessories



1

Part No.	511487	Ref. No.	00011053
description	funnel		



1

Part No.	511163	Ref. No.	00003731 373A
description	screw for rinse aid container		

boilers

boilers for dishwashers

1

Part No.	511899	Ref. No.	00013771
description	boiler		



1

Part No.	511901	Ref. No.	00003440
description	boiler		



1

Part No.	511896	Ref. No.	00211009
description	boiler ø 120mm L 270mm		



1

Part No.	511898	Ref. No.	00210410
description	boiler ø 140mm L 270mm		



1

Part No.	511897	Ref. No.	00222040
description	boiler ø 140mm L 270mm flange 4 hole inlet ø 50		



1

Part No.	511900	Ref. No.	00010500
description	boiler ø 170mm L 440mm		

accessories



1

Part No.	699274	Ref. No.	00010514
description	connecting fitting for boiler thread 1/2" L 75mm W 32mm hose ø 14/5mm		



1

Part No.	511817	Ref. No.	00010502
description	T-piece connection 1/4" ET - 1/2" IT hose ø 13mm 1/4" ET - 1/2" IT hose ø 13mm		

rotation plates

rotation plate bearings

1

Part No.	519419	Ref. No.	00005491
description	spindle for rotation plate ø 47mm		



softener cartridges

softening columns



1

Part No.	530001	Ref. No.	12145001
-----------------	--------	-----------------	----------

description softener 4-fold L 380mm W 180mm

housing and bezels

fascias



1

Part No.	403262	Ref. No.	00222433
-----------------	--------	-----------------	----------

description control panel warewashing BE35 W 178mm H 48mm D 58mm suitable for ELFRAMO

hood mechanics for dishwashers

bolts



1

Part No.	511888	Ref. No.	00018051
-----------------	--------	-----------------	----------

description screw bolt hood mechanics

springs



1

Part No.	511623	Ref. No.	00002320
-----------------	--------	-----------------	----------

description spring for hood mechanics



1

Part No.	511625	Ref. No.	00002330
-----------------	--------	-----------------	----------

description spring for hood mechanics

hood handle supports



1

Part No.	511560	Ref. No.	00018030 00018049 00018165
-----------------	--------	-----------------	----------------------------------

description handle holder hood mechanics H 42mm ø 90mm

rollers



1

Part No.	511876	Ref. No.	00013784
-----------------	--------	-----------------	----------

description roller ED ø 40mm ID ø 11mm



1

Part No.	511595	Ref. No.	00065842
-----------------	--------	-----------------	----------

description roller set ø 30mm H 24mm for dishwasher hole ø 15mm

cable controls



1

Part No.	511118	Ref. No.	00002350
-----------------	--------	-----------------	----------

description cable control foot switch for hood



1

Part No.	511152	Ref. No.	00002370
-----------------	--------	-----------------	----------

description hauling cable L 900mm hood mechanics



miscellaneous



1			
Part No.	511887	Ref. No.	00018050
description	bush hood mechanics		



1			
Part No.	511885	Ref. No.	00018026
description	handle holder hood mechanics		

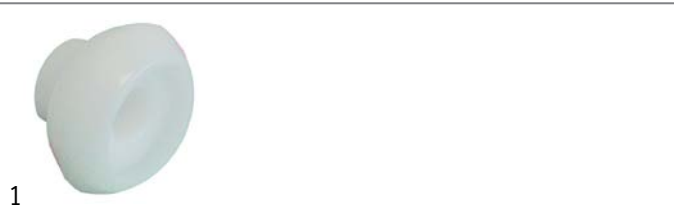

1			
Part No.	511886	Ref. No.	00018021
description	roller hood mechanics		

basket guides

guide bars



1			
Part No.	699273	Ref. No.	00073240
description	guide for rack conveyor dishwashing machine L 50mm W 45mm H 80mm with rollers		

basket holders

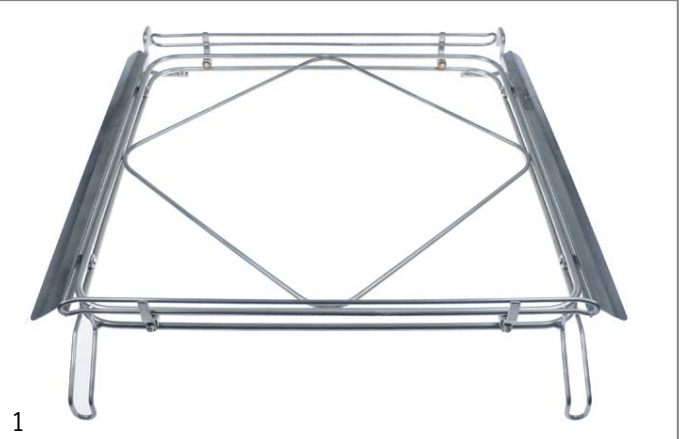

1			
Part No.	971059	Ref. No.	00018060 00018404
description	basket support L 640m W 560mm H 110mm		

air traps



1			
Part No.	511067	Ref. No.	00002180
description	air trap		

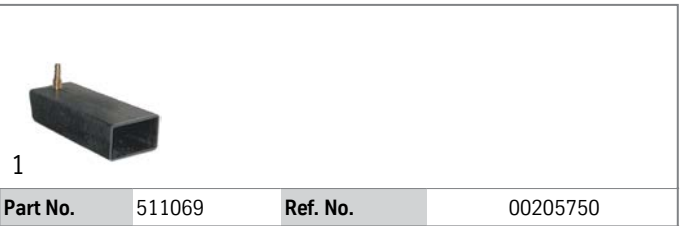

1			
Part No.	511069	Ref. No.	00205750
description	air trap		





1			
Part No.	511820	Ref. No.	00012716
description	air trap		



1			
Part No.	511821	Ref. No.	00013984
description	air trap		



			
1			
Part No.	511824	Ref. No.	00014098
description	air trap		

			
1			
Part No.	519465	Ref. No.	00014087
description	air trap ø 45mm H 160mm thread 3/8" hose ø 6mm		



air trap accessories

			
1			
Part No.	511823	Ref. No.	00012719
description	hose connector		

backflow preventers

backflow preventers

			
1			
Part No.	511124	Ref. No.	23180200 23180202
description	backflow preventer dishwasher		

			
1			
Part No.	516101	Ref. No.	23180203
description	backflow preventer dishwasher hose ø 12mm		
spare parts for	516101		
	Part No.	506367	Ref. No. —
	flat gasket rubber ED ø 40mm ID ø 28mm thickness 1.8mm Qty 1 pcs		

door mechanics

springs

roller springs

			
1			
Part No.	519550	Ref. No.	00079740
description	roller spring W 25.35mm		

			
1			
Part No.	519491	Ref. No.	00079730
description	roller spring W 26mm		

			
1			
Part No.	519543	Ref. No.	00065816
description	roller spring with holder W 46mm ID ømm lug lengthmm		

linkage

			
1			
Part No.	511906	Ref. No.	00210993
description	door pin L 210mm tie bar		

			
1			
Part No.	511881	Ref. No.	00210366
description	door pin mounting pos. left complete tie bar		



1

Part No.	511872	Ref. No.	00210940
description	tie bar		

2



Part No.	511884	Ref. No.	00001710
description	tie bar complete		

1



Part No.	511871	Ref. No.	00210983
description	tie bar L 260mm		

1

Part No.	511883	Ref. No.	00010730
description	tie bar mounting pos. left complete		

1



Part No.	511880	Ref. No.	00210361
description	tie bar mounting pos. right complete		

1



Part No.	511882	Ref. No.	00010720
description	tie bar mounting pos. right complete		

threaded shafts

1



Part No.	511879	Ref. No.	00210939
description	threaded part threaded part		

sliding plates

1



Part No.	511907	Ref. No.	00013777
description	sliding plate		

1



Part No.	511878	Ref. No.	00013780
description	sliding plate sliding plate		

rollers

1



Part No.	501431	Ref. No.	00013907
description	roller ED ø 9mm for door mechanism shaft diameter 3.5mm W 5mm		

hinges

1





Part No.	519417	Ref. No.	00065309
description	door hinge		

1



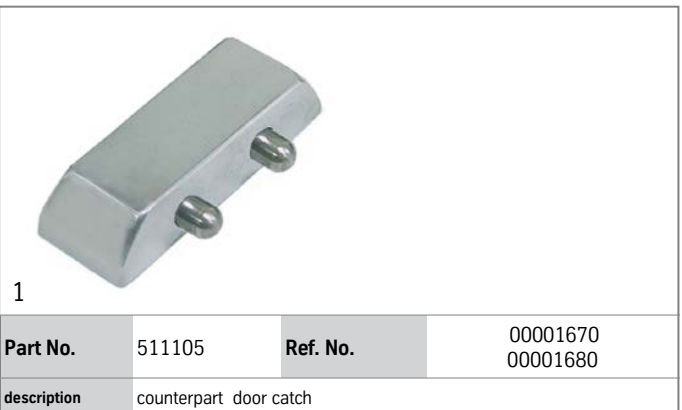
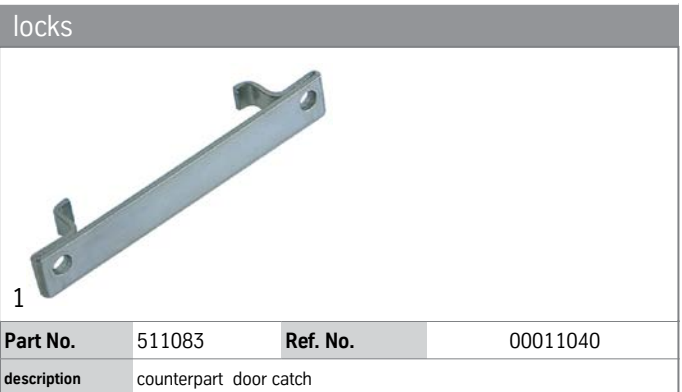
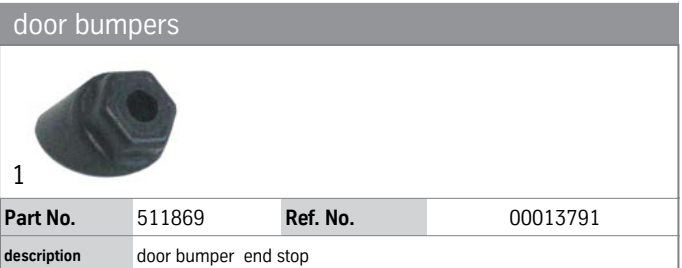
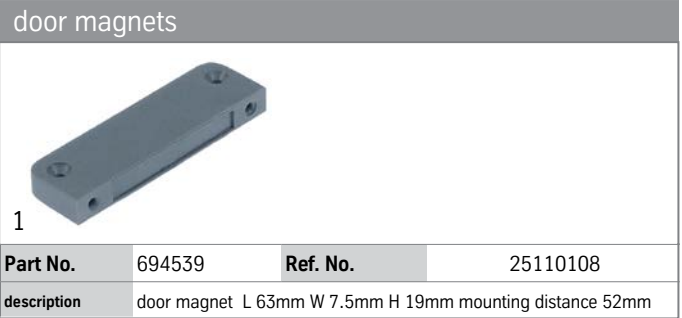
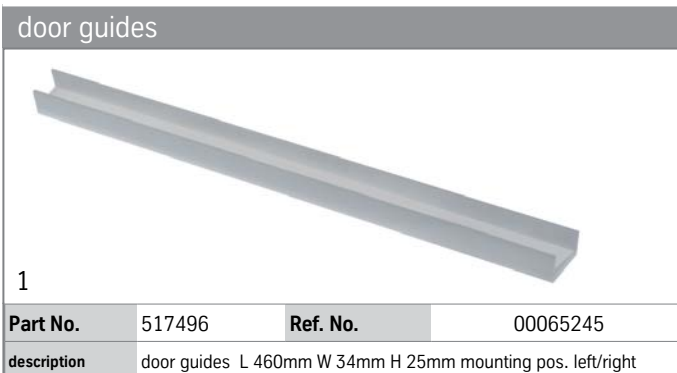
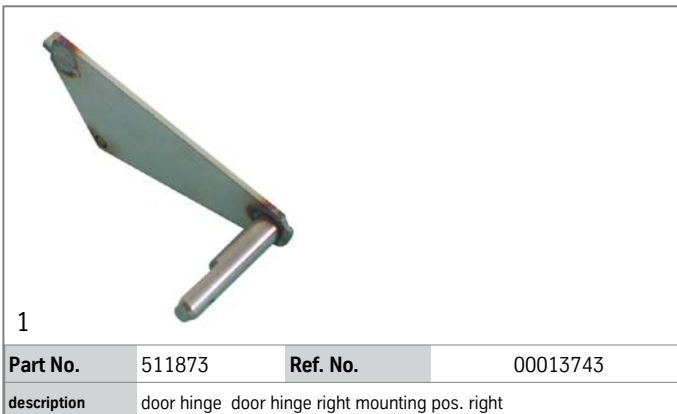
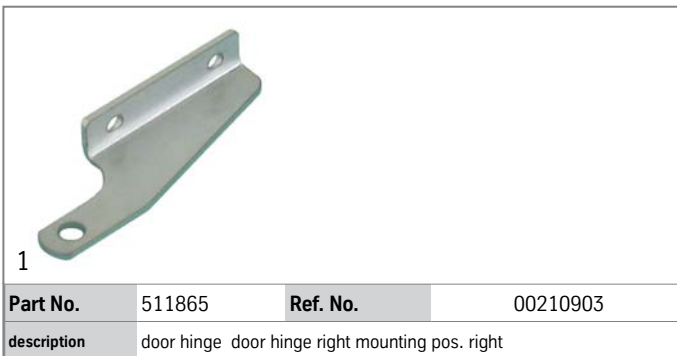
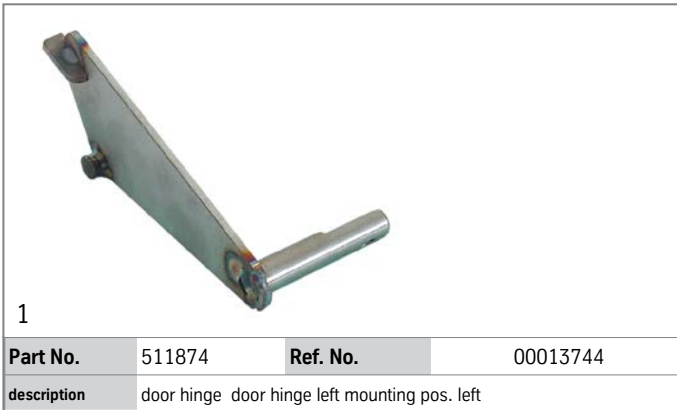

Part No.	511866	Ref. No.	00210902
description	door hinge door hinge left mounting pos. left		







1

Part No.	511104	Ref. No.	00001630 00001640
description	door catch		
accessories for	511104		
	Part No.	511105	Ref. No.
			00001670 00001680
	counterpart door catch		



1

Part No.	511082	Ref. No.	00011028
description	door catch complete catch		
accessories for	511082		
	Part No.	511083	Ref. No.
			00011040
	counterpart door catch		

miscellaneous



1

Part No.	524047	Ref. No.	00013786
description	hauling cable for door mechanism \varnothing 1.5mm L 475mm		



1

Part No.	511877	Ref. No.	00222059
description	hauling cable hauling cable		



1

Part No.	511868	Ref. No.	00013829
description	hinge complete hinge		



1

Part No.	511594	Ref. No.	00220340
description	hinge for dishwasher door set D1 \varnothing 20mm D2 \varnothing 12mm		



1

Part No.	519408	Ref. No.	00013909
description	linkage guide for tie bar complete		

screw connections



1

Part No.	519409	Ref. No.	00013785
description	screw		

curtains



1

Part No.	533013	Ref. No.	00076010
description	curtain W 620mm H 550mm warewashing		



1

Part No.	533021	Ref. No.	00062000 00062030
description	curtain W 650mm H 450mm plastic thickness 1.5mm		



washing and rinsing systems



1			
Part No.	511716	Ref. No.	00222102
description	null		



1			
Part No.	511781	Ref. No.	00202632
description	rinse arm support mounting pos. upper		



1			
Part No.	511728	Ref. No.	00018077
description	rinse pipe		



1			
Part No.	511730	Ref. No.	00014042
description	rinse pipe		



1			
Part No.	511732	Ref. No.	00013779
description	rinse pipe		



1			
Part No.	517503	Ref. No.	00018038 00018261 00018352
description	rinse pipe L 770mm		



1			
Part No.	511720	Ref. No.	00211015
description	rinse pipe mounting pos. lower		



1			
Part No.	511714	Ref. No.	00222103
description	rinse pipe mounting pos. upper		



1			
Part No.	511624	Ref. No.	00005080
description	rinse pipe ø 10mm L 400mm connection 3/8"		



1			
Part No.	511016	Ref. No.	00005010
description	screw connection		



1			
Part No.	511741	Ref. No.	02120040
description	throttle disc		



1			
Part No.	511704	Ref. No.	00018076
description	Thumb screw		



1			
Part No.	511484	Ref. No.	00003950
description	T-piece thread 1 1/4" H 82mm L 120mm		





1			
Part No.	511713	Ref. No.	00222111
description	wash arm bearing		





1			
Part No.	511729	Ref. No.	00014041
description	wash arm bearing		





 <p>1</p>			
Part No.	511592	Ref. No.	00011858 00014286
description	wash pipe L 730mm suitable for ELFRAMO		

 <p>1</p>			
Part No.	517505	Ref. No.	00018260
description	wash pipe L 870mm SS		

 <p>1</p>			
Part No.	511492	Ref. No.	00005110
description	wash pipe mounting pos. lower ø 34mm L 153mm		

 <p>1</p>			
Part No.	511493	Ref. No.	00005120
description	wash pipe mounting pos. lower ø 38mm L 176mm		

 <p>1</p>			
Part No.	511489	Ref. No.	00005140
description	wash pipe mounting pos. lower ø 39mm L 233mm		

 <p>1</p>			
Part No.	511491	Ref. No.	00005130
description	wash pipe ø 38mm L 214mm		

handles and hand wheels

bracket handles

 <p>1</p>			
Part No.	511100	Ref. No.	00001510 00009200
description	pull handle		

 <p>1</p>			
Part No.	511115	Ref. No.	00001530 00009220
description	pull handle L 445mm H 62mm mounting distance 425mm		

recessed handles



 <p>1</p>			
Part No.	511889	Ref. No.	00205530
description	recessed handle		

 <p>1</p>			
Part No.	511890	Ref. No.	00010610
description	recessed handle		

fittings for catering equipment

outlet taps

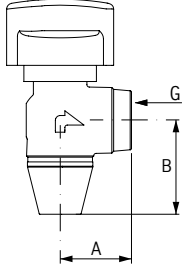
universal

  <p>1</p>			
Part No.	541609	Ref. No.	00030401
description	outlet tap chrome-plated brass W 46mm H 40mm thread 1" IT		
spare parts for	541609		
	Part No.	540747	Ref. No. —
	outlet tap chrome-plated brass angled W 30mm H 40mm thread 1/2" IT		



drain taps

brass

drain taps



1

Part No.	540260	Ref. No.	00030400
description	drain tap		



1

Part No.	970515	Ref. No.	00007400
description	mix basket ED ø 440mm H 145mm seat ø 445mm		



1

Part No.	970516	Ref. No.	00007420
description	mix basket ED ø 500mm H 125mm seat ø 445mm		

plate baskets



1

Part No.	970513	Ref. No.	00007320
description	plate basket ED ø 495mm H 120mm seat ø 445mm plates 18		

steel wire baskets square

glass basket



1

Part No.	971052	Ref. No.	00206720
description	glass basket L 470mm W 470mm H 150mm number of rows 3 rows spacing 145mm		

mix baskets



1

Part No.	970078 ¹	Ref. No.	00007100
description	mix basket		

¹wide-meshed



1

Part No.	971006 ¹	Ref. No.	00206711
description	mix basket L 345mm W 345mm H 120mm mesh type wide-meshed		

¹wide-meshed

equipment feet and end caps

screw-in feet



1

Part No.	695604	Ref. No.	00000970
description	equipment foot thread M10 thread L 32mm ø 50mm H 14mm		



1

Part No.	695601	Ref. No.	00206960
description	equipment foot thread M17 thread L 23mm ø 24mm H 11mm plastic WS 24 Qty 1 pcs		

baskets

warewashing baskets

steel wire baskets round

mix baskets



1

Part No.	970514	Ref. No.	00206731
description	mix basket ED ø 330mm H 145mm		

1

Part No.	970068 ¹	Ref. No.	00206712
description	mix basket L 400mm W 400mm H 170mm		
spare parts for	970068		
	Part No.	970001	Ref. No.
	sliding corner wire gauge \varnothing 5mm L 120mm W 120mm H 12mm L-shape		

¹wide-meshed



1

Part No.	971049 ¹	Ref. No.	00206713
description	mix basket L 460mm W 460mm		

¹wide-meshed



1

Part No.	970074 ¹	Ref. No.	00007120
description	mix basket L 500mm W 500mm H 130mm mesh type close-meshed		

¹fine-meshed



1

Part No.	970027 ¹	Ref. No.	00007140
description	mix basket L 550mm W 550mm H 125mm mesh type close-meshed		

¹fine-meshed

plate baskets

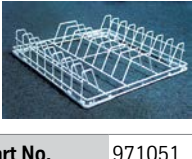

1

Part No.	971051	Ref. No.	00007000
description	plate basket L 470mm W 470mm H 100mm plates 16 plate \varnothing 240mm		



1

Part No.	971043	Ref. No.	00007040
description	plate basket L 500mm W 500mm H 130mm plates 20 plate \varnothing 240mm		



1

Part No.	970026	Ref. No.	00007060
description	plate basket L 550mm W 550mm H 130mm plates 24 plate \varnothing 270mm		

accessories

cutlery inserts



1

Part No.	976011	Ref. No.	00206721
description	cutlery insert Lmm Wmm \varnothing 110mm H 130mm		

plate inserts



1

Part No.	970047	Ref. No.	00206751 00206752
description	plate insert L 308mm W 100mm plates 15		

gaskets

O-rings

EPDM

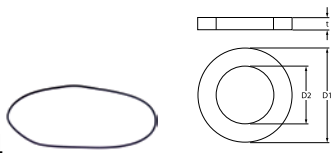

1

Part No.	521717	Ref. No.	00002900 06140008 06140140
description	O-ring EPDM thickness 1.78mm ID \varnothing 120.37mm Qty 1 pcs		

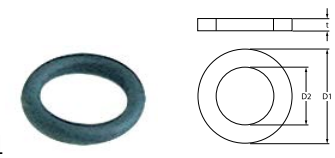

1

Part No.	529412	Ref. No.	06140003
description	O-ring EPDM thickness 2.62mm ID \varnothing 10.78mm Qty 1 pcs		

Part No. 507313 **Ref. No.** 06140002

description O-ring EPDM thickness 2.62mm ID ø 13.95mm Qty 1 pcs

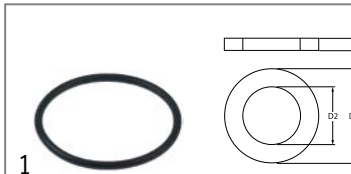

Part No. 532451 **Ref. No.** 06140028

description O-ring EPDM thickness 3.53mm ID ø 53.98mm Qty 1 pcs

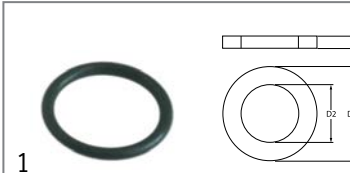

Part No. 528919 **Ref. No.** 00004480

description O-ring EPDM thickness 2.62mm ID ø 20.24mm Qty 1 pcs

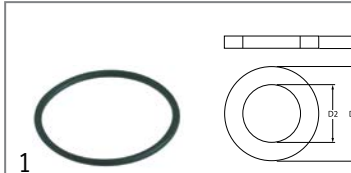

Part No. 511828 **Ref. No.** 06140018

description O-ring EPDM thickness 3.53mm ID ø 56.74mm Qty 1 pcs



Part No. 505073 **Ref. No.** 06140005

description O-ring EPDM thickness 2.62mm ID ø 20.63mm Qty 1 pcs

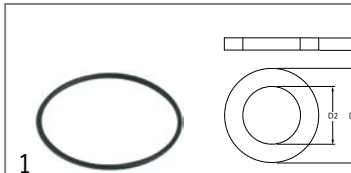

Part No. 511711 **Ref. No.** 06140026

description O-ring EPDM thickness 3.53mm ID ø 78.97mm Qty 1 pcs



Part No. 510769 **Ref. No.** 06140004

description O-ring EPDM thickness 2.62mm ID ø 25.07mm Qty 1 pcs

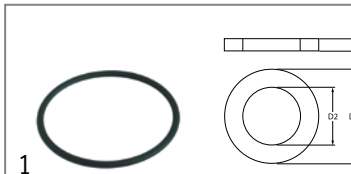

Part No. 505178 **Ref. No.** 06140035

description O-ring EPDM thickness 5.34mm ID ø 85.09mm Qty 1 pcs

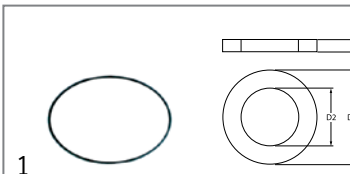

Part No. 510554 **Ref. No.** 00002900
06140008
06140140

description O-ring EPDM thickness 2mm ID ø 120mm Qty 1 pcs

sealing washers

fibre gaskets



Part No. 506042 **Ref. No.** 06110006
06120004

description flat gasket FIBER ED ø 27mm ID ø 17mm thickness 2mm Qty 1 pcs

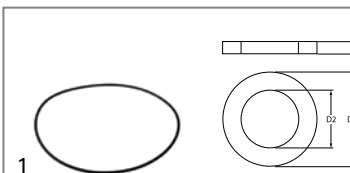

Part No. 521718 **Ref. No.** 00002910
06140010

description O-ring EPDM thickness 3.53mm ID ø 164.7mm Qty 1 pcs



Part No. 511490 **Ref. No.** 06120001

description flat gasket fibre ED ø 15mm ID ø 8mm thickness 2mm Qty 1 pcs



plastic gaskets



1			
Part No.	696557	Ref. No.	06113001
description	flat gasket polyoxymethylene ED ø 14mm ID ø 10mm thickness 1.5mm Qty 1 pcs		



1			
Part No.	696375	Ref. No.	00010504
description	gasket plastic ED ø 19mm ID ø 10.5mm thickness 6mm for boiler Qty 1 pcs		

copper gaskets

DIN-7603-A



1			
Part No.	560523	Ref. No.	02150006
description	flat gasket nickel-plated copper ED ø 18.5mm ID ø 12.2mm thickness 2mm Qty 1 pcs		

PTFE gaskets



1			
Part No.	511589	Ref. No.	06112001
description	flat gasket PTFE ED ø 11mm ID ø 4.5mm thickness 2mm Qty 1 pcs		

shaft gaskets

v-rings



1			
Part No.	511213	Ref. No.	00530523
description	V-ring		

special gaskets

miscellaneous



1			
Part No.	511106	Ref. No.	00001470
description	window gasket		

miscellaneous

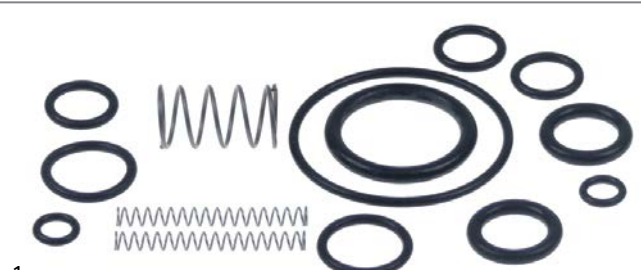

1			
Part No.	551099	Ref. No.	CP11011
description	gasket set cram whipping machine Qty set 14-piece		

springs

compression springs

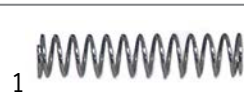

1			
Part No.	511117	Ref. No.	0000235A 00073718
description	compression spring ø 14.2/8.1mm L 53mm wire gauge ø 1.2mm cone-shaped		

roller springs

roller springs



1			
Part No.	511116	Ref. No.	00002301 0000230A
description	roller spring mounting pos. left complete		
spare parts for	511116		



	Part No.	511622	Ref. No.	00002310
	description	roller spring mounting pos. right/left W 40mm		



			
1			
Part No.	511127	Ref. No.	00002300
description	roller spring mounting pos. right complete		
spare parts for	511127		
	Part No.	511622	Ref. No. 00002310
	roller spring mounting pos. right/left W 40mm		

			
1			
Part No.	511622	Ref. No.	00002310
description	roller spring mounting pos. right/left W 40mm		

			
1			
Part No.	519550	Ref. No.	00079740
description	roller spring W 25.35mm		

			
1			
Part No.	519491	Ref. No.	00079730
description	roller spring W 26mm		

			
1			
Part No.	519543	Ref. No.	00065816
description	roller spring with holder W 46mm ID 8mm lug lengthmm		

tension springs

			
1			
Part No.	361593	Ref. No.	812
description	spring		

			
1			
Part No.	511875	Ref. No.	00013719
description	tension spring		

			
1			
Part No.	511904	Ref. No.	00013717
description	tension spring ø 15.1mm total length 148mm wire gauge ø 1.7mm		

			
1			
Part No.	511216	Ref. No.	00018056
description	tension spring ø 25mm total length 790mm wire gauge ø 5mm L1 120mm L2 580mm D1 ø 23mm thread M8 thread L 90mm mounting pos. left/right for hood		

dosing pumps

peristaltic dosing pumps

SEKO

built-in version

with frequency control



1			
Part No.	361215	Ref. No.	20155100 20155111 old version
description	dosing pump SEKO frequency control 0.3-3.0l/h 230VAC detergent hose ø 4x6mm hose type K hose Santoprene suction level 1.5m type PBR protection IP55 dimensions 100x67x68mm power input 3.5W		

spare parts for	361215		
------------------------	--------	--	--

	Part No.	361136	Ref. No.	—
	roller assembly for dosing pump hole ø 4.8x4mm			

	Part No.	361226	Ref. No.	—
	PCB L 59mm W 26mm electronic control			

	Part No.	361815	Ref. No.	20155112
	pump hose detergent hose ø 6x10mm hose ø 4x6mm hose type K hose Santoprene type SEKO			

accessories for	361215		
------------------------	--------	--	--









	Part No.	361142	Ref. No.	—
	mounting set detergent hose type 4x6mm hose length 2m PVC 2x hose/container filter/tank intake transparent			

Table continues overleaf



accessories for 361215				
	Part No.	520090	Ref. No.	07125002
	PVC hose ID ø 4mm ED ø 6mm L 2m thickness 1mm t.max. 60°C transparent			
	Part No.	520091	Ref. No.	20155110
	nylon hose ID ø 4mm ED ø 6mm L 2m thickness 1mm operating p. 10bar burst p. 50bar t.max. 100°C transparent			

with time control

 <p>1</p>				
Part No.	361768 ¹	Ref. No.	00220423 old version 20155104 old version	
description	dosing pump SEKO time control 0.4l/h 230VAC rinse aid hose ø 4x6mm hose type D hose Sekobril suction level 1.5m type NBM 0.4 8W with accessories 8VA dosing time 0-30s			
spare parts for	361768			
	Part No.	361135	Ref. No.	20155109
	pump hose SEKO rinse aid hose ø 3x8mm hose ø 4x6mm hose type D hose Sekobril			
	Part No.	361141	Ref. No.	20155105
	container filter with weight ceramic hose ø 4mm			
	Part No.	361821	Ref. No.	00220419
	non-return valve inlet 4x6mm outlet 1/4" L 45mm			
	Part No.	520091	Ref. No.	20155110
	nylon hose ID ø 4mm ED ø 6mm L 2m thickness 1mm operating p. 10bar burst p. 50bar t.max. 100°C transparent			
	Part No.	520242	Ref. No.	—
	silicone hose for peristaltic pump ID ø 4mm ED ø 7mm L 5m thickness 1.5mm t.max. 200°C Shore A 55° transparent dosing Qty 5m			

¹with accessories







spare parts

  <p>1</p>				
Part No.	361815	Ref. No.	20155112	
description	pump hose detergent hose ø 6x10mm hose ø 4x6mm hose type K hose Santoprene type SEKO			
 <p>1</p>				
Part No.	361135	Ref. No.	20155109	
description	pump hose SEKO rinse aid hose ø 3x8mm hose ø 4x6mm hose type D hose Sekobril			
spare parts for	361135			
	Part No.	361866	Ref. No.	—
	union nut for hose connector ø 17mm			

membrane dosing pumps

self-priming





SEKO



 <p>1</p>				
Part No.	361594	Ref. No.	20155108	
description	dosing pump type DIB3E rinse aid pump rate 0-3cm ³ per stroke pressure connection ø 4x6mm suction connection ø 4x6mm			
spare parts for	361594			
	Part No.	361240	Ref. No.	—
	hose connector 1-way hose ø 6mm plastic connection M10x1			
	Part No.	361301	Ref. No.	—
	hose connector for type DIB3E/DIB5E			
	Part No.	361302	Ref. No.	—
	valve bush for type DIB3E/DIB5E			
	Part No.	361304	Ref. No.	—
	O-ring EPDM ID ø 11.11mm thickness 1.78mm Qty 1 pcs for type DIB3E/DIB5E			
	Part No.	361305	Ref. No.	—
	valve disc for type DIB3E/DIB5E DIB3P/DIB5P			
	Part No.	361306	Ref. No.	—
	membrane for type DIB3E/DIB5E ø 49mm hole ø 5mm			
	Part No.	361481	Ref. No.	—
	lip valve for type DIB3P/DIB5P DIB3E/DIB5E			

 <p>1</p>				
Part No.	361837 ¹	Ref. No.	2015511+00019656 20155117	
description	dosing pump type DIB5E conversion kit rinse aid pump rate 0-5cm ³ per stroke pressure connection ø 4x6mm suction connection ø 6mm SEKO			
spare parts for	361837			
	Part No.	361301	Ref. No.	—
	hose connector for type DIB3E/DIB5E			
	Part No.	361302	Ref. No.	—
	valve bush for type DIB3E/DIB5E			

¹auxiliary pressure connection closed
Table continues overleaf



spare parts for		361837	
	Part No.	361304	Ref. No. —
O-ring EPDM ID ø 11.11mm thickness 1.78mm Qty 1 pcs for type DIB3E/DIB5E			
	Part No.	361305	Ref. No. —
valve disc for type DIB3E/DIB5E DIB3P/DIB5P			
	Part No.	361306	Ref. No. —
membrane for type DIB3E/DIB5E ø 49mm hole ø 5mm			
	Part No.	361307	Ref. No. —
membrane dosing pump ø 68mm hole ø 6mm for type DIB3P/DIB5P			
	Part No.	361481	Ref. No. —
lip valve for type DIB3P/DIB5P DIB3E/DIB5E			

accessories for		361837	
	Part No.	361240	Ref. No. —
hose connector 1-way hose ø 6mm plastic connection M10x1			
	Part No.	361241	Ref. No. —
hose connector 1-way hose ø 9mm plastic connection M10x1			

accessories

	1		
Part No.	361141	Ref. No.	20155105
description container filter with weight ceramic hose ø 4mm			

non-return valves

	1		
Part No.	361821	Ref. No.	00220419
description non-return valve inlet 4x6mm outlet 1/4" L 45mm			

	1		
Part No.	361147	Ref. No.	20155106
description non-return valve inlet 4x6mm outlet 1/8" L 50mm Qty 1 pcs			

hoses

dosing hoses



	1		
Part No.	511164	Ref. No.	00003780
description dosing hose ED ø 10mm ID ø 6mm L 1800mm dosing			

PVC hoses

	1		
Part No.	520090	Ref. No.	07125002
description PVC hose ID ø 4mm ED ø 6mm L 2m thickness 1mm t.max. 60°C transparent			
accessories for		520090	
	Part No.	361058	Ref. No. —
container filter with non-return valve SS hose ø 4x6mm ø 20mm L 56mm			
	Part No.	361066	Ref. No. —
container filter straight SS hose ø 4x6mm L 37mm non return valve ball valve			
	Part No.	361106	Ref. No. —
container filter with weight and non-return valve SS hose ø 4x6mm ø 21mm L 51mm non return valve lip valve			
	Part No.	361141	Ref. No. 20155105
container filter with weight ceramic hose ø 4mm			
	Part No.	361230	Ref. No. —
container filter with weight stainless steel hose ø 4x6mm			
	Part No.	361462	Ref. No. —
container filter with weight SS hose ø 4x6mm			
	Part No.	361728	Ref. No. —
container filter with 4m 4x6 hose SS hose ø 4x6mm hose length 4000mm			

hose couplings

plastic

	1		
Part No.	511593	Ref. No.	00220440
description hose connector T-shape plastic thread 1/2" ø 13mm for dosing pump			
spare parts for		511593	
	Part No.	361083	Ref. No. —
union nut T1: M10x1 for hose 6mm			



tank inlets



Part No.	361416	Ref. No.	20155114
description	tank inlet SS M12 hose ø 6mm		

hoses

supply hoses

stainless steel flexi hoses

universal hoses



Part No.	520627	Ref. No.	00053360
description	flex hose SS braid straight-straight DN12 connections 3/4" L 2000mm approval DVGW operating p. 10bar test pressure 32bar burst p. 95bar		



Part No.	520395	Ref. No.	00003540
description	flex hose SS braid straight-straight DN8 connections 3/8"-1/2" L 230mm Qty 2 pcs		



Part No.	520459	Ref. No.	00003530
description	flex hose SS braid straight-straight DN8 connections 3/8"-1/2" L 740mm approval DVGW operating p. 10bar test pressure 32bar burst p. 95bar		

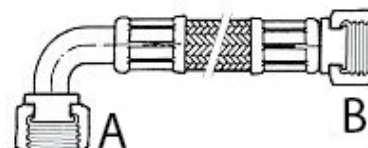

Part No.	520007	Ref. No.	336A
description	flex hose SS braid straight-curved DN15 connection 1: 3/4" connection 2: 3/4" L 2500mm approval operating p. 10bar test pressure 32bar burst p. 95bar		

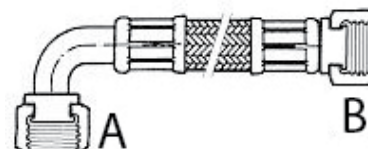
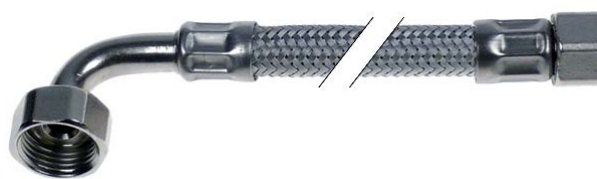

Part No.	520468	Ref. No.	12160008
description	flex hose SS braid straight-curved DN8 connection 1: 1/2" connection 2: 3/8" L 350mm approval DVGW operating p. 10bar test pressure 32bar burst p. 95bar		

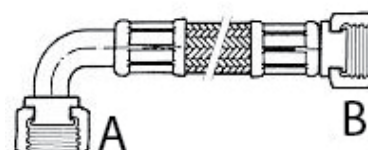



Part No.	520396	Ref. No.	00003550
description	flex hose SS straight-curved L 170mm connections 3/8"-1/2"		



PVC supply hoses



1

Part No.	520010	Ref. No.	00200720 07130001 07130002
description	supply hose PVC straight-curved DN13 connections 3/4" L 1500mm operating p. 10bar burst p. 32bar t.max. 90°C blue approval VDE flat seal		
accessories for	520010		
	Part No.	520053	Ref. No. —
	screen connection 3/4" D1 ø 26mm D2 ø 15mm Qty 10 pcs rubber thickness 8mm		
	Part No.	520054	Ref. No. —
	flat gasket rubber ED ø 23.5mm ID ø 14mm thickness 2.3mm Qty 10 pcs		

pre-rinse hoses

stainless steel flexi hoses



1

Part No.	542859	Ref. No.	00980050
description	shower hose connections 1/2" L 1200mm SS operating p. 10bar burst p. 90bar t.max. 90°C for pre-rinse units suitable for drinking water rotary with flexible fabric		

drain hoses



1

Part No.	511206	Ref. No.	07130157
description	drain hose		



1

Part No.	513718	Ref. No.	00003630 00003640 00200652 00200653
description	drain hose DN19 L 1500mm straight ø inside 24mm straight ext. ø 28mm outer hose ø 23mm		

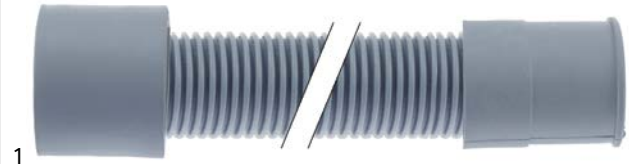

1

Part No.	511205	Ref. No.	07130156 364
description	drain hose DN19 L 1500mm A int. ø 23mm A ext. ø 29mm B int. ø 29mm outer hose ø 29mm B ext. ø 35mm		



1

Part No.	530399	Ref. No.	07130158
description	drain hose DN31 L 2000mm A int. ø 33mm A ext. ø 39mm B int. ø 33mm B ext. ø 39mm outer hose ø 35mm		

industrial hoses

nylon hoses



1

Part No.	520091	Ref. No.	20155110
description	nylon hose ID ø 4mm ED ø 6mm L 2m thickness 1mm operating p. 10bar burst p. 50bar t.max. 100°C transparent		

PVC hoses

PVC hoses without fabric



1

Part No.	520090	Ref. No.	07125002
description	PVC hose ID ø 4mm ED ø 6mm L 2m thickness 1mm t.max. 60°C transparent		
accessories for	520090		
	Part No.	361058	Ref. No. —
	container filter with non-return valve SS hose ø 4x6mm ø 20mm L 56mm		
	Part No.	361066	Ref. No. —
	container filter straight SS hose ø 4x6mm L 37mm non return valve ball valve		
	Part No.	361106	Ref. No. —
	container filter with weight and non-return valve SS hose ø 4x6mm ø 21mm L 51mm non return valve lip valve		
	Part No.	361141	Ref. No. 20155105
	container filter with weight ceramic hose ø 4mm		
	Part No.	361230	Ref. No. —
	container filter with weight stainless steel hose ø 4x6mm		
	Part No.	361462	Ref. No. —
	container filter with weight SS hose ø 4x6mm		
	Part No.	361728	Ref. No. —
	container filter with 4m 4x6 hose SS hose ø 4x6mm hose length 4000mm		



silicone hoses

without fabric



1

Part No.	530410	Ref. No.	00003750 00011065
description	silicone hose ID ø 4mm ED ø 7mm L 2m thickness 1.5mm t.max. 200°C transparent		



1

Part No.	511140	Ref. No.	00010540
description	formed hose warewashing L-shape equiv. no. 00010540		

formed hoses

straight



1

Part No.	511048	Ref. No.	00004060 00200671 00200676 00200678
description	formed hose dishwasher straight equiv. no. 00004060		

with branch



1

Part No.	511859	Ref. No.	00013718
description	formed hose warewashing equiv. no. 00013718 with piggyback		



1

Part No.	511858	Ref. No.	00013827
description	formed hose dishwasher straight equiv. no. 00013827		



1

Part No.	511056	Ref. No.	00206911
description	formed hose warewashing with piggyback		

form L



1

Part No.	511050	Ref. No.	00004070
description	formed hose end piece A int. ø 50mm ø end piece B 70mm L 190mm warewashing L-shape equiv. no. 00004070		



1

Part No.	511057	Ref. No.	00206912
description	formed hose warewashing with piggyback		



1	Part No.	511058	Ref. No.	00206909
	description	formed hose warewashing with piggyback		

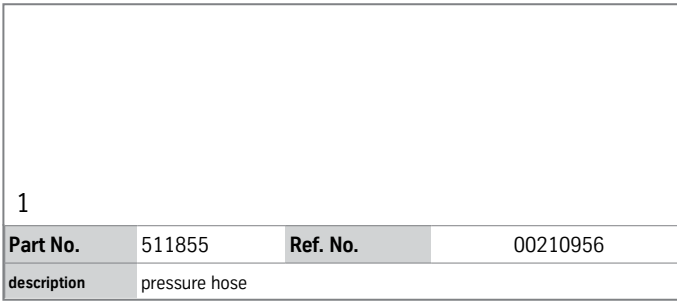

1	Part No.	511855	Ref. No.	00210956
	description	pressure hose		



1	Part No.	511857	Ref. No.	00222108
	description	pressure hose		



1	Part No.	511863	Ref. No.	00206901
	description	pressure hose		

form S



1	Part No.	517498	Ref. No.	00018312
	description	formed hose hose ext. ø 78mm hose int. ø 63mm L 310mm S-shape		



1	Part No.	511856	Ref. No.	00222109
	description	formed hose S-shape warewashing equiv. no. 00222109		

miscellaneous



1	Part No.	511047	Ref. No.	00004110
	description	formed hose warewashing equiv. no. 00004110		

for dishwashers

miscellaneous



1	Part No.	511468	Ref. No.	00200691
	description	pressure hose		



1	Part No.	511467	Ref. No.	00003520 00013411
	description	pressure hose L 1000mm		



1			
Part No.	511464	Ref. No.	00013340
description	pressure hose L 480mm ø 18mm		

1			
Part No.	511465	Ref. No.	00200641
description	pressure hose L 690mm ø 25mm		

fittings, hose and pipe connectors

fittings

T-pieces

miscellaneous

1			
Part No.	511499	Ref. No.	00000350
description	T-piece thread 3/8" brass L 58mm		

hose connectors

producer-specific

1			
Part No.	511071	Ref. No.	00002140
description	hose connector for drain		

valves and tank inlets

ball valves

producer-specific

KOMEL

1				
Part No.	514429	Ref. No.	13110004	
description	ball valve connection 1" IT - 1" ET total length 71mm			
accessories for	514429			
	Part No.	540752	Ref. No.	00030450
	extension for outlet tap L 165mm			
	Part No.	694062	Ref. No.	00030470
	extension for outlet tap L 400mm			

1				
Part No.	540751	Ref. No.	003041 13110001	
description	ball valve connection 1" IT - tube ø25mm total length 59mm			
accessories for	540751			
	Part No.	540752	Ref. No.	00030450
	extension for outlet tap L 165mm			
	Part No.	540753	Ref. No.	—
	handle L 400mm for outlet tap			
	Part No.	694062	Ref. No.	00030470
	extension for outlet tap L 400mm			

1			
Part No.	540752	Ref. No.	00030450
description	extension for outlet tap L 165mm		

1			
Part No.	694062	Ref. No.	00030470
description	extension for outlet tap L 400mm		



shut-off valves

universal

1				
Part No.	693107	Ref. No.	00003770 13100001	
description	shut-off valve connection 1/2" 1/2" cold total length 54mm L1 27mm L2 30mm marking blue rosette thread G2 26x19G connection ø M4x0.7 ITmm			
spare parts for	693107			
	Part No.	514085	Ref. No.	—
	rosette connection 26x19G chrome-plated total lengthmm mounting pos.			
	Part No.	514086	Ref. No.	—
	hexagonal nut connection 26x19G brass total lengthmm mounting pos. H 6mm WS 34 Qty 1 pcs			
	Part No.	540672	Ref. No.	—
	gasket suitable for tap head			
	Part No.	547711	Ref. No.	—
	hood handle shaft intake ø 8mm marking blue metal H2 21mm D1 ø 33mm type D suitable for MONOLITH shaft length H1 8mm			

Table continues overleaf



spare parts for	693107		
	Part No.	548168	Ref. No. —
	star handle connection hot total lengthmm mounting pos. ø 57mm marking red		
	Part No.	548169	Ref. No. —
	star handle connection cold total lengthmm mounting pos. chrome-plated ø 57mm		
accessories for	693107		
	Part No.	514086	Ref. No. —
	hexagonal nut connection 26x19G brass total lengthmm mounting pos. H 6mm WS 34 Qty 1 pcs		

water cycle components

pressure reduction valves

pressure reduction valves

universal



1

Part No.	520871	Ref. No.	00074380 23200001 23200002
description	pressure reduction valve MALGORANI series Eurobrass 143 connection 1/2" default settingbar setting range 0.5-6bar p max 25bar t.max. 80°C brass		

supply filters



1

Part No.	511485	Ref. No.	00003480 00003481
description	T-piece thread 1/2" -3/4" brass with filter H 100mm L 175mm		

ancillary products

clamps

hose clamps

DIN 3017 - W2



1

Part No.	520116	Ref. No.	05100011
description	hose clamp ø 32-50mm width 9mm Qty 5 pcs DIN 3017		



1

Part No.	520118	Ref. No.	05100002 05100004
description	hose clamp ø 50-70mm width 9mm Qty 5 pcs DIN 3017		



1

Part No.	520454	Ref. No.	0000407B 05100008
description	hose clamp ø 70-90mm width 9mm Qty 5 pcs DIN 3017		



1

Part No.	520110	Ref. No.	05100006
description	hose clamp ø 8-12mm width 9mm Qty 10 pcs DIN 3017		

double wire clamps



1

Part No.	520872	Ref. No.	00003751 05110001
description	hose clamp ø 7mm wire gauge ø 1mm Qty 1 pcs		



measuring equipment

thermometers

built-in thermometers



1

Part No.	541086	Ref. No.	32110003
description	thermometer mounting measurements 58x25.5mm 0 up to +120°C capillary pipe 2000mm probe ø 6mm probe L 23mm		

ø40mm



1

Part No.	541037	Ref. No.	32110002
description	thermometer mounting ø 40mm t.max. 120°C 0 up to +120°C probe ø 6.5mm probe L 25mm capillary pipe 2000mm		

ø52mm



1

Part No.	541065	Ref. No.	00006010
description	thermometer mounting ø 52mm t.max. 120°C 0 up to +120°C probe ø 6.5mm probe L 28mm capillary pipe 1500mm		



1

Part No.	541303	Ref. No.	3053 32100002
description	thermometer mounting ø 52mm t.max. 200°C +150 up to +200°C probe ø 4mm probe L 75mm capillary pipe 1370mm		

ø60mm



1

Part No.	541791	Ref. No.	00074420 32100003
description	thermometer mounting ø 60mm t.max. 120°C 0-120°C probe ø 6mm probe L 39mm capillary pipe 1500mm		

fastening material

screws

countersunk screws



1

Part No.	560337	Ref. No.	01350001
description	countersunk screw thread M6 L 20mm WS 4 SS DIN 7991/ISO 10642 Qty 1 pcs intake hexagonal		

miscellaneous



1

Part No.	511494	Ref. No.	00002160
description	flat-headed bolt thread M5x0.8 thread L 7.8mm head ø 18mm intake slotted		



1

Part No.	519409	Ref. No.	00013785
description	screw		

nuts

hexagonal nuts

DIN 934 / ISO 4032/8673



1

Part No.	511212	Ref. No.	03100006
description	hexagonal nut thread M6 H 5mm WS 10 SS DIN/ISO DIN 934 / ISO 4032/8673 Qty 1 pcs		



washers

washers

DIN 125A



1

Part No.	560113	Ref. No.	02120006
description	plain washer ID ø 6.4mm ED ø 12mm thickness 1.6mm SS Qty 20 pcs DIN 125A for thread M6		



1

Part No.	511481	Ref. No.	02120008
description	plain washer ID ø 8.4mm ED ø 16mm thickness 1.6mm zinc-coated steel Qty 1 pcs DIN 125A for thread M8		

miscellaneous



1

Part No.	511591	Ref. No.	02160100
description	disc ID ø 16mm ED ø 20mm thickness 1.5mm brass Qty 1 pcs		

fasteners

clamps

hose clamps

DIN 3017 - W2



1

Part No.	520116	Ref. No.	05100011
description	hose clamp ø 32-50mm width 9mm Qty 5 pcs DIN 3017		



1

Part No.	520118	Ref. No.	05100002 05100004
description	hose clamp ø 50-70mm width 9mm Qty 5 pcs DIN 3017		



1

Part No.	520454	Ref. No.	0000407B 05100008
description	hose clamp ø 70-90mm width 9mm Qty 5 pcs DIN 3017		



1

Part No.	520110	Ref. No.	05100006
description	hose clamp ø 8-12mm width 9mm Qty 10 pcs DIN 3017		

double wire clamps



1

Part No.	520872	Ref. No.	00003751 05110001
description	hose clamp ø 7mm wire gauge ø 1mm Qty 1 pcs		

consumables

fuses

fine fuses

ø10x38mm 400V



1

Part No.	358041	Ref. No.	00060970
description	fine fuse size ø10x38mm 20A slow-acting rated 400V type aM Qty 1 pcs		



1

Part No.	358030	Ref. No.	00060980
description	fine fuse size ø10x38mm 32A slow-acting rated 400V type aM Qty 1 pcs		

ø10x38mm 500V



1

Part No.	358038	Ref. No.	00060960 37130999
description	fine fuse size ø10x38mm 10A slow-acting rated 500V type aM Qty 1 pcs		



			
1			
Part No.	358040	Ref. No.	00006261
description	fine fuse size ø10x38mm 16A slow-acting rated 500V type aM Qty 1 pcs		

GASTROPARTS.COM

