



GASTROPARTS

King

- [EN]** Equipment
- [DE]** Geräte
- [ES]** Aparatos
- [FR]** Équipement
- [IT]** Attrezzature
- [PL]** Urządzenia
- [RU]** Оборудование

✉ gastroparts@gastroparts.com

☎ +48 56 657 00 66

📘 fb.com/gastroparts.global

GASTROPARTS.COM





heating elements

heating elements for ovens

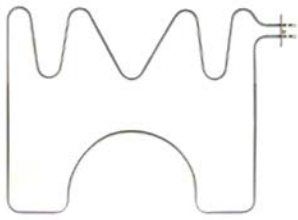



1

Part No.	418247	Ref. No.	OK9753
description	heating element 2000W 220V L 600mm W 450mm L1 55mm L2 545mm W1 390mm W2 30mm flange length 70mm flange width 15mm hole distance 56mm hole ø 6mm tube ø 6.5mm connection length 30mm connection male faston 6.3mm heating circuits 1 rectangular flange dry heating element oven		

heating elements for bain maries



1

Part No.	415565	Ref. No.	OK9905
description	heating element 1500W 230V heating circuits 1 L 350mm W 180mm hole distance 22mm connection male faston 6.3mm tube ø 8.5mm compression flange immersion heater flange ø 32mm H 20mm mounting ø 32mm mounting thread M5		
spare parts for	415565		
	Part No.	510364	Ref. No. —
	gasket Lmm Wmm ø 36mm for heating element thickness 3mm with 4 screw holes		
accessories for	415565		
	Part No.	510365	Ref. No. —
	counterflange ø 36mm Lmm Wmm		

heating elements for griddles

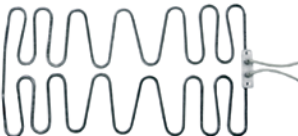

1

Part No.	415363	Ref. No.	OK9904
description	heating element 3000W 230V heating circuits 1 L 450mm W 242mm H 20mm tube ø 6.3mm W1 104mm W2 31mm rectangular flange hole distance 56mm cable length 340mm flange length 70mm flange width 23mm hole ø 5mm dry heating element		
accessories for	415363		
	Part No.	510368	Ref. No. —
	gasket L 70mm W 23.5mm hole ø 5mm hole distance 56mm FIBER thickness 2mm for heating element		

heating elements for contact grills







1

Part No.	415648	Ref. No.	OH9684
description	heating element 660W 230V L 212mm W 72mm H 35mm tube ø 6.3mm L1 34mm L2 178mm W1 58mm W2 14mm connection cable length 210mm dry heating element		

heating elements for chargrills







1

Part No.	415647	Ref. No.	OK9752
description	heating element 1000W 230V heating circuits 1 L 440mm W 30mm H 6.5mm 2 hole fixing thread M10x1 mounting distance 33mm dry heating element tube ø 6.5mm cable length 320mm connection length 41mm		
accessories for	415647		
	Part No.	510416	Ref. No. —
	flat gasket fibre ED ø 19mm ID ø 10.5mm thickness 1.5mm for thread M10 Qty 1 pcs		
	Part No.	510893	Ref. No. —
	O-ring EPDM thickness 2.62mm ID ø 9.92mm Qty 1 pcs		
	Part No.	520231	Ref. No. —
	nut thread M10x1 H 6mm WS 14 zinc-coated steel Qty 1 pcs		
	Part No.	521129	Ref. No. —
	nut thread M10 H 6mm SS WS 17 Qty 1 pcs DIN/ISO DIN 439		



1

Part No.	415646	Ref. No.	OK9751
description	heating element 700W 230V heating circuits 1 L 444mm W 37mm 2 hole fixing thread M10x1 mounting distance 30mm dry heating element tube ø 6.5mm cable length 440mm connection length 22mm		
accessories for	415646		
	Part No.	510416	Ref. No. —
	flat gasket fibre ED ø 19mm ID ø 10.5mm thickness 1.5mm for thread M10 Qty 1 pcs		
	Part No.	510893	Ref. No. —
	O-ring EPDM thickness 2.62mm ID ø 9.92mm Qty 1 pcs		
	Part No.	520231	Ref. No. —
	nut thread M10x1 H 6mm WS 14 zinc-coated steel Qty 1 pcs		
	Part No.	521129	Ref. No. —
	nut thread M10 H 6mm SS WS 17 Qty 1 pcs DIN/ISO DIN 439		



ceramic heaters

245x60mm



1

Part No.	415104	Ref. No.	0A2843
-----------------	--------	-----------------	--------

description ceramic emitter 1000W 230V cable beaded cord L 245mm W 60mm H 35mm

spare parts for 415104

Part No.	415109	Ref. No.	—
-----------------	--------	-----------------	---



spring clip

accessories for 415104

Part No.	415110	Ref. No.	—
-----------------	--------	-----------------	---



reflector L 245mm W 95mm H 31mm thickness 0.75mm hole ø 15x40mm

round

with radiused edge

for domestic and commercial kitchens

E-G-O



1

Part No.	490016	Ref. No.	OK0350
-----------------	--------	-----------------	--------

description hot plate ø 180mm 2000W 230V connection 4 screw clamps with 8mm spill ring



1

Part No.	490018	Ref. No.	OK0334
-----------------	--------	-----------------	--------

description hot plate ø 220mm 2000W 230V connection 4 screw clamps with 8mm spill ring

hot plates

square & rectangular

tiltable



1

Part No.	490085	Ref. No.	OK9761
-----------------	--------	-----------------	--------

description hot plate dimensions 300x300mm 2500W 230V with cast edge tilt boiling plate connection 3 screw clamps H 43mm square

E-G-O

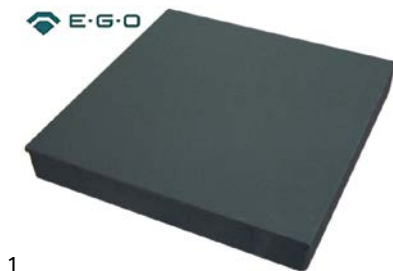

1

Part No.	490089	Ref. No.	OK0371
-----------------	--------	-----------------	--------

description hot plate dimensions 300x300mm 4000W 230V with cast edge tilt boiling plate connection 4 screw clamps H 43mm square

energy regulators

EGO

1-circuit

E-G-O



1

Part No.	380015	Ref. No.	OC1605
-----------------	--------	-----------------	--------

description energy regulator 230V 13A single-circuit turn direction right shaft ø 6x4.6mm shaft L 23mm mounting thread M4 power release 6-100% no. 50.57021.010



thermostats

control and safety thermostats

EGO

control thermostats

55.34_ series

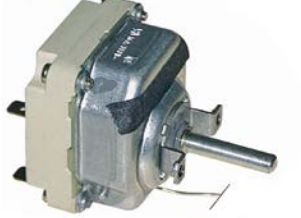

1

Part No.	375143	Ref. No.	004911
description	thermostat t.max. 110°C temperature range 32-110°C 3-pole 3NO 16A probe ø 6mm probe L 138mm capillary pipe 1480mm capillary pipe isolated 1100mm gland nut M9x1 shaft ø 6x4.6mm shaft L 23mm shaft position upper rotation 270°		



1

Part No.	375038	Ref. No.	0H6217
description	thermostat t.max. 300°C temperature range 50-300°C 3-pole 3NO 16A probe ø 6mm probe L 79mm capillary pipe 1740mm capillary pipe isolated 800mm gland nut shaft ø 6x4.6mm shaft L 23mm shaft position upper rotation 270°		
accessories for	375038		
	Part No.	110123	Ref. No. —
	knob thermostat t.max. 300°C ø 50mm shaft ø 6x4.6mm shaft flat upper black temperature range 50-300°C rotation 270°		

safety thermostats

55.31_ series



1

Part No.	375521	Ref. No.	0H7487
description	safety thermostat switch-off temp. 240°C 3-pole 20A probe ø 6mm probe L 177mm capillary pipe 2380mm capillary pipe isolated 1100mm gland nut M9x1 probe SS		

accessories

gland nut accessories

ducts



1

Part No.	550271	Ref. No.	OK9769
description	gland duct ET M12x0.75 IT M9x1 with gasket and nut		

switches and momentary switches

cam switches

on/off



1

Part No.	300021	Ref. No.	OK9771
description	cam switch 4 operating positions 4NO sequence 0-1-0-1 16A shaft ø 6x4.6mm shaft L 23mm connection screw ceramic		

4-position

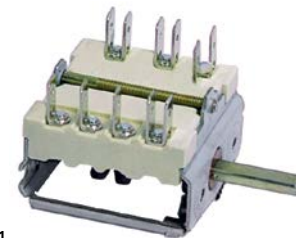

1

Part No.	300007	Ref. No.	0H6602
description	cam switch 4 operating positions 1NO/2CO sequence 0-1-2-3 16A shaft ø 6x4.6mm shaft L 23mm connection male faston 6.3mm 4-position ceramic		

7-position



1

Part No.	300004	Ref. No.	OK6627
description	cam switch 7 operating positions 1NO/2CO sequence 0-1-2-3-4-5-6 16A shaft ø 6x4.6mm shaft L 23mm connection male faston 6.3mm 7-position ceramic		



operation switches

E-G-O



1

Part No.	300002	Ref. No.	0A2134
description	cam switch 2 operating positions 4NO 16A sequence 0-1 shaft ø 6x4.6mm shaft L 23mm connection male faston 6.3mm ceramic		

lamps

indicator lights

lamps

neon light bulbs



1

Part No.	359602	Ref. No.	0H7036
description	neon light bulb socket E14 230V clear ø 14mm L 30mm		



1

Part No.	359603	Ref. No.	0H7037
description	neon light bulb socket E14 380V clear ø 14mm L 30mm		

screw-on/push-on fit

neon light bulbs



1

Part No.	359602	Ref. No.	0H7036
description	neon light bulb socket E14 230V clear ø 14mm L 30mm		



1

Part No.	359603	Ref. No.	0H7037
description	neon light bulb socket E14 380V clear ø 14mm L 30mm		

linear lamps

infrared lamps

with base type Z ceramic



1

Part No.	359625	Ref. No.	0K9756
description	infrared lamp socket Z-ceramic L 226mm 220-250V 500W cable length 195mm IMPORT		

solenoid valves

solenoid valves (water)

metal

MÜLLER

2-way



1

Part No.	370035	Ref. No.	0H6405
description	solenoid valve 2-ways 230VAC inlet 3/4" ET outlet 1/2" IT L 57mm water MÜLLER		

motors

gear motors

for gyros grills



1

Part No.	500805	Ref. No.	0K9826
description	gear motor AEG type M008 230V 50/60Hz 2rpm shaft ø 10mm L 71mm W 71mm H 48mm for gyro grills		















gas taps

PEL

23S/V series



1

Part No.	101630	Ref. No.	OK9985
description	gas tap PEL type 23S/V gas inlet 1/2" IT bypass nozzle \varnothing 0.35mm gas outlet 1/2" MT (tube \varnothing 14mm) thermocouple connection M10x1 pilot connection M10x1 shaft \varnothing 10mm shaft L 25mm shaft flat		
spare parts for	101630		
	Part No.	100455	Ref. No. —
	bypass nozzle type PEL23/24 bore \varnothing 0.35mm thread M8x0.5		
	Part No.	101059	Ref. No. —
	magnet unit T1: M10x1 T2: M22x1 L 46mm \varnothing 18mm suitable for PEL23S M10x1		
	Part No.	102767	Ref. No. —
	gas tap front part shaft \varnothing 10mm shaft L 26.5mm shaft flat suitable for PEL23S		
accessories for	101630		
	Part No.	100908	Ref. No. —
	union screw thread M10x1 for pipe \varnothing 4mm Qty 1 pcs		
	Part No.	100909	Ref. No. —
	union screw thread M10x1 for pipe \varnothing 6mm Qty 1 pcs		
	Part No.	100945	Ref. No. —
	roll pin \varnothing 3.2mm L 10mm		
	Part No.	101218	Ref. No. —
	shaft extension JUNKERS		
	Part No.	101219	Ref. No. —
	shaft extension L 25mm JUNKERS		
	Part No.	101246	Ref. No. —
	olive for pipe \varnothing 4mm Qty 1 pcs		
	Part No.	101286	Ref. No. —
	olive ID \varnothing 6mm Qty 1 pcs		
	Part No.	110064	Ref. No. —
	knob		
	Part No.	110066	Ref. No. —
	knob screw		
	Part No.	550396	Ref. No. —
	shaft extension L 25mm JUNKERS		

alternatives to JUNKERS

	1		
Part No.	101630	Ref. No.	OK9985
description	gas tap PEL type 23S/V gas inlet 1/2" IT bypass nozzle \varnothing 0.35mm gas outlet 1/2" MT (tube \varnothing 14mm) thermocouple connection M10x1 pilot connection M10x1 shaft \varnothing 10mm shaft L 25mm shaft flat		
spare parts for	101630		
	Part No.	100455	Ref. No. —
	bypass nozzle type PEL23/24 bore \varnothing 0.35mm thread M8x0.5		
	Part No.	101059	Ref. No. —
	magnet unit T1: M10x1 T2: M22x1 L 46mm \varnothing 18mm suitable for PEL23S M10x1		
	Part No.	102767	Ref. No. —
	gas tap front part shaft \varnothing 10mm shaft L 26.5mm shaft flat suitable for PEL23S		
accessories for	101630		
	Part No.	100908	Ref. No. —
	union screw thread M10x1 for pipe \varnothing 4mm Qty 1 pcs		
	Part No.	100909	Ref. No. —
	union screw thread M10x1 for pipe \varnothing 6mm Qty 1 pcs		
	Part No.	100945	Ref. No. —
	roll pin \varnothing 3.2mm L 10mm		
	Part No.	101218	Ref. No. —
	shaft extension JUNKERS		
	Part No.	101219	Ref. No. —
	shaft extension L 25mm JUNKERS		
	Part No.	101246	Ref. No. —
	olive for pipe \varnothing 4mm Qty 1 pcs		
	Part No.	101286	Ref. No. —
	olive ID \varnothing 6mm Qty 1 pcs		
	Part No.	110064	Ref. No. —
	knob		
	Part No.	110066	Ref. No. —
	knob screw		
	Part No.	550396	Ref. No. —
	shaft extension L 25mm JUNKERS		



EGA

24197 series

gas taps



1

Part No.	101150	Ref. No.	OK0213
description	gas tap EGA type 24197 series with pipe outlet		
spare parts for	101150		
	Part No.	101058	Ref. No. —
	magnet unit L 39mm D1 ø 15.4mm D2 ø 13.5mm suitable for PEL22/ EGA24197 standard		
	Part No.	101230	Ref. No. —
	thermocouple nut T1: M8x1 T2: M18x1 aluminium		
accessories for	101150		
	Part No.	100944	Ref. No. —
	union nut thread M18x1.5 for pipe ø 12mm		
	Part No.	101273	Ref. No. —
	olive for pipe ø 12mm L 9.5mm brass Qty 1 pcs suitable for universal		
	Part No.	101284	Ref. No. —
	olive for pipe ø 4mm Qty 1 pcs		
	Part No.	101285	Ref. No. —
	union screw thread M8x1 for pipe ø 4mm Qty 1 pcs JUNKERS		

ignition parts

ignition cables

pre-assembled cables



1

Part No.	100025	Ref. No.	OK0998
description	ignition cable cable length 600mm connection ø4mm / F6.3mm		

piezoelectric igniters

mounting diameter 22mm



1

Part No.	100005	Ref. No.	OH6070
description	piezoelectric igniter body plastic blowing mounting ø 22mm connection ø2.4mm cable lengthmm SIT		

miscellaneous



1

Part No.	nla ¹	Ref. No.	058225
description	piezoelectric igniter body metal connection F6.3x0.8 2 hole fixing ø 22mm		

¹no longer available

ignition units



1

Part No.	101015	Ref. No.	004248
description	ignition unit outputs 4 230VAC 0.6VA 50Hz		

thermocouples

plug-in thermocouples

plug-in thermocouples standard

with barrel socket ø6mm

type Junkers with aluminised tip

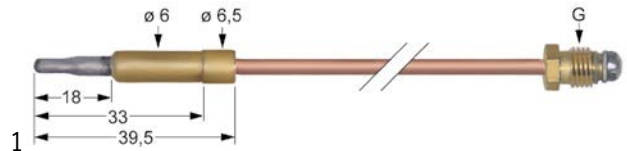

1

Part No.	102229	Ref. No.	OH6174
description	thermocouple M10x1 L 1000mm plug connection ø6.0mm		

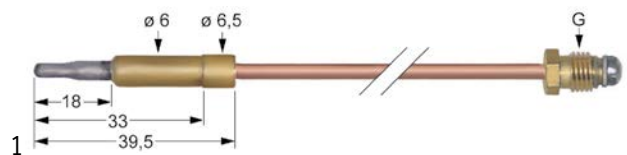

1

Part No.	102231	Ref. No.	OK0687
description	thermocouple M10x1 L 1500mm plug connection ø6.0mm		



knobs

universal knobs

1

Part No.	110232	Ref. No.	0112134
description	knob switch 4-position t.max.°C 50mm shaft ø 6x4.6mm shaft flat upper black		

1

Part No.	110234	Ref. No.	0112138
description	knob switch 7-position t.max.°C 50mm shaft ø 6x4.6mm shaft flat upper black		

1

Part No.	110241	Ref. No.	0102025
description	knob thermostat t.max. 110°C ø 50mm shaft ø 6x4.6mm shaft flat upper black temperature range 30-110°C		

1

Part No.	110242	Ref. No.	0K9909
description	knob thermostat t.max. 180°C ø 50mm shaft ø 6x4.6mm shaft flat upper black temperature range 100-180°C		

1

Part No.	110245	Ref. No.	0102024
description	knob thermostat t.max. 300°C ø 50mm shaft ø 6x4.6mm shaft flat upper black temperature range 50-300°C		

producer-specific knobs

KING

1

Part No.	110232	Ref. No.	0112134
description	knob switch 4-position t.max.°C 50mm shaft ø 6x4.6mm shaft flat upper black		

1

Part No.	110234	Ref. No.	0112138
description	knob switch 7-position t.max.°C 50mm shaft ø 6x4.6mm shaft flat upper black		

1

Part No.	110241	Ref. No.	0102025
description	knob thermostat t.max. 110°C ø 50mm shaft ø 6x4.6mm shaft flat upper black temperature range 30-110°C		

1

Part No.	110245	Ref. No.	0102024
description	knob thermostat t.max. 300°C ø 50mm shaft ø 6x4.6mm shaft flat upper black temperature range 50-300°C		



baskets

fryer baskets

KING



1

Part No.	970439	Ref. No.	OK9832
description	fryer basket ø 230mm H1 145mm chrome-plated steel		

GASTROPARTS.COM

