



**GASTROPARTS**

# Isa

- [EN]** Equipment
- [DE]** Geräte
- [ES]** Aparatos
- [FR]** Équipement
- [IT]** Attrezzature
- [PL]** Urządzenia
- [RU]** Оборудование

✉ [gastroparts@gastroparts.com](mailto:gastroparts@gastroparts.com)

☎ +48 56 657 00 66

📘 [fb.com/gastroparts.global](https://fb.com/gastroparts.global)

**GASTROPARTS.COM**





## heating elements

### heating cartridges

1 

|                    |                                                                                                           |                 |                             |
|--------------------|-----------------------------------------------------------------------------------------------------------|-----------------|-----------------------------|
| <b>Part No.</b>    | 419216                                                                                                    | <b>Ref. No.</b> | 41850002800<br>418500028000 |
| <b>description</b> | heating cartridge 250W 230V ø 11mm L 116mm cable length 2000mm connection male faston 6.3mm refrigeration |                 |                             |

1 

|                    |                                                                                                                        |                 |              |
|--------------------|------------------------------------------------------------------------------------------------------------------------|-----------------|--------------|
| <b>Part No.</b>    | 419218                                                                                                                 | <b>Ref. No.</b> | 418500030100 |
| <b>description</b> | heating cartridge 400W 230V ø 11mm L 240mm thread 3/8" cable length 550mm connection female faston 6.3mm refrigeration |                 |              |

1 

|                    |                                                                                               |                 |              |
|--------------------|-----------------------------------------------------------------------------------------------|-----------------|--------------|
| <b>Part No.</b>    | 419217                                                                                        | <b>Ref. No.</b> | 418500020000 |
| <b>description</b> | heating cartridge 700W 230V ø 11mm L 355mm cable length 1500mm connection female faston 6.3mm |                 |              |

## thermostats

### bi-metal thermostats

1 

|                    |                                                                                                |                 |             |
|--------------------|------------------------------------------------------------------------------------------------|-----------------|-------------|
| <b>Part No.</b>    | 390930                                                                                         | <b>Ref. No.</b> | 50501404000 |
| <b>description</b> | bi-metal thermostat switch-off temp. 10°C 1-pole starting temperature -1°C cable length 2500mm |                 |             |

## timers

### programme timers

1 

|                    |                                                                                                         |                 |             |
|--------------------|---------------------------------------------------------------------------------------------------------|-----------------|-------------|
| <b>Part No.</b>    | 360590                                                                                                  | <b>Ref. No.</b> | 50502800200 |
| <b>description</b> | timer EI30/15.5 engines chambers operation time 25s 230V 50/60Hz shaft ømm shaft Lmm RITARDAT.RT-123/00 |                 |             |

## relays

### power relays

#### with bracket mounting

1 

|                    |                                                                                                 |                 |                         |
|--------------------|-------------------------------------------------------------------------------------------------|-----------------|-------------------------|
| <b>Part No.</b>    | 380687                                                                                          | <b>Ref. No.</b> | 30506030<br>50500601400 |
| <b>description</b> | power relays FINDER 230VAC 30A 2NO connection F6.3 bracket mounting manuf. no. 66.82.8.230.0300 |                 |                         |

## electronic controllers

### CAREL

#### refrigeration controllers

##### built-in version

1 

|                    |                                                                                                                                                                                                                         |                 |              |
|--------------------|-------------------------------------------------------------------------------------------------------------------------------------------------------------------------------------------------------------------------|-----------------|--------------|
| <b>Part No.</b>    | 378491                                                                                                                                                                                                                  | <b>Ref. No.</b> | 418200090000 |
| <b>description</b> | electronic controller CAREL PZIACOH010K mounting measurements 71x29mm built-in depth 59mm 230V voltage AC NTC relay outputs 3 NO-12A CO-8A NO-8A NTC NTC protection IP65 ISA-TASSELLI -40 up to +99°C display 3½ digits |                 |              |

### DIXELL

#### refrigeration controllers

##### built-in version

1 

|                    |                                                                                                                                                                                                                                        |                 |             |
|--------------------|----------------------------------------------------------------------------------------------------------------------------------------------------------------------------------------------------------------------------------------|-----------------|-------------|
| <b>Part No.</b>    | 378492                                                                                                                                                                                                                                 | <b>Ref. No.</b> | 41825755200 |
| <b>description</b> | electronic controller DIXELL XR72CX mounting measurements 71x29mm built-in depth 59mm 12V voltage AC/DC NTC/PTC relay outputs 4 NO-16A NO-8A NO-8A NO-5A DI NTC/PTC NTC/PTC yes protection IP65 dependend on probe°C display 3½ digits |                 |             |



## built-in version 2-piece



1

|                                                                                   |                                                                                                                                                                                                      |                 |                              |
|-----------------------------------------------------------------------------------|------------------------------------------------------------------------------------------------------------------------------------------------------------------------------------------------------|-----------------|------------------------------|
| <b>Part No.</b>                                                                   | 378490                                                                                                                                                                                               | <b>Ref. No.</b> | 418249561100<br>418249561200 |
| <b>description</b>                                                                | power PCB DIXELL XM470K-510C1 mounting measurements 132x152mm built-in depth 40mm 230V voltage AC NTC relay outputs 5 NO-20A NO-16A NO-8A NO-8A NTC NTC NTC digital digital yes protection°C display |                 |                              |
| <b>accessories for</b>                                                            | 378490                                                                                                                                                                                               |                 |                              |
|  | <b>Part No.</b>                                                                                                                                                                                      | 378278          | <b>Ref. No.</b> —            |
|                                                                                   | keypad unit DIXELL T640 mounting measurements 150x30mm built-in depth 23mmV voltage relay outputs°C display 3½ digits                                                                                |                 |                              |







## ELIWELL











## refrigeration controllers

## built-in version



1

|                                                                                     |                                                                                                                                                                                                                     |                 |                              |
|-------------------------------------------------------------------------------------|---------------------------------------------------------------------------------------------------------------------------------------------------------------------------------------------------------------------|-----------------|------------------------------|
| <b>Part No.</b>                                                                     | 381403                                                                                                                                                                                                              | <b>Ref. No.</b> | 418200073000<br>418200073100 |
| <b>description</b>                                                                  | electronic controller ELIWELL type EWPlus 974 mounting measurements 71x29mm 230V voltage AC NTC relay outputs 4 NO-12A(8) NO-8A(4) NC-6A(3) NO-5A(2) NTC NTC DI defr. funct. yes -50 up to +110°C display 3½ digits |                 |                              |
| <b>accessories for</b>                                                              | 381403                                                                                                                                                                                                              |                 |                              |
|  | <b>Part No.</b>                                                                                                                                                                                                     | 379052          | <b>Ref. No.</b> —            |
|                                                                                     | temperature probe PTC 1kOhm cable silicone probe -50 up to +150°C cable -50 up to +180°C probe ø6x40mm cable length 1.5m without screw connection 2-wire                                                            |                 |                              |
|  | <b>Part No.</b>                                                                                                                                                                                                     | 379053          | <b>Ref. No.</b> —            |
|                                                                                     | temperature probe PTC 1kOhm cable PVC probe -50 up to +150°C cable -10 up to 100°C probe ø6x30mm cable length 3m without screw connection 2-wire                                                                    |                 |                              |
|  | <b>Part No.</b>                                                                                                                                                                                                     | 379064          | <b>Ref. No.</b> —            |
|                                                                                     | temperature probe PTC 1kOhm cable silicone probe -50 up to +150°C cable -50 up to +180°C probe ø6x40mm cable length 3m without screw connection 2-wire                                                              |                 |                              |
|  | <b>Part No.</b>                                                                                                                                                                                                     | 379142          | <b>Ref. No.</b> —            |
|                                                                                     | temperature probe PTC 1kOhm cable PVC probe -50 up to +150°C cable -10 up to 100°C probe ø6x30mm cable length 1.5m without screw connection 2-wire                                                                  |                 |                              |
|  | <b>Part No.</b>                                                                                                                                                                                                     | 379160          | <b>Ref. No.</b> —            |
|                                                                                     | temperature probe NTC 10kOhm cable thermoplastic probe -40 up to +110°C cable -40 up to +110°C probe ø6x14mm cable length 1.5m without screw connection 2-wire                                                      |                 |                              |
|  | <b>Part No.</b>                                                                                                                                                                                                     | 379161          | <b>Ref. No.</b> —            |
|                                                                                     | temperature probe NTC 10kOhm cable thermoplastic probe -40 up to +110°C cable -40 up to +110°C probe ø6x14mm cable length 3m without screw connection 2-wire                                                        |                 |                              |

|                                                                                     |                                                                                                                                                                                |        |                   |
|-------------------------------------------------------------------------------------|--------------------------------------------------------------------------------------------------------------------------------------------------------------------------------|--------|-------------------|
| <b>accessories for</b>                                                              | 381403                                                                                                                                                                         |        |                   |
|    | <b>Part No.</b>                                                                                                                                                                | 379162 | <b>Ref. No.</b> — |
|                                                                                     | temperature probe NTC 10kOhm cable thermoplastic probe -40 up to +110°C cable -40 up to +110°C probe ø6x14mm cable length 6m 2-wire                                            |        |                   |
|    | <b>Part No.</b>                                                                                                                                                                | 379169 | <b>Ref. No.</b> — |
|                                                                                     | temperature probe NTC 10kOhm cable thermoplastic probe -40 up to +110°C cable -40 up to +110°C probe ø6x14mm cable length 2m without screw connection 2-wire                   |        |                   |
|    | <b>Part No.</b>                                                                                                                                                                | 379199 | <b>Ref. No.</b> — |
|                                                                                     | temperature probe PTC 1kOhm cable PVC probe -50 up to +150°C cable -10 up to 100°C probe ø6x30mm cable length 5m without screw connection 2-wire                               |        |                   |
|    | <b>Part No.</b>                                                                                                                                                                | 379343 | <b>Ref. No.</b> — |
|                                                                                     | temperature probe NTC 10kOhm cable silicone probe -40 up to +110°C cable -50 up to +180°C probe ø6x40mm cable length 3m 2-wire                                                 |        |                   |
|    | <b>Part No.</b>                                                                                                                                                                | 379458 | <b>Ref. No.</b> — |
|                                                                                     | temperature probe NTC 10kOhm cable silicone probe -40 up to +110°C cable -50 up to +180°C probe ø6x40mm cable length 1.5m without screw connection 2-wire                      |        |                   |
|    | <b>Part No.</b>                                                                                                                                                                | 379630 | <b>Ref. No.</b> — |
|                                                                                     | temperature probe NTC 10kOhm cable thermoplastic probe -40 up to +110°C cable -40 up to +110°C probe ø6x14mm cable length 2.5m without screw connection 2-wire resistor 10kOhm |        |                   |
|    | <b>Part No.</b>                                                                                                                                                                | 379804 | <b>Ref. No.</b> — |
|                                                                                     | protector for electronic controller 71x29 L 93mm W 65mm plexiglas                                                                                                              |        |                   |
|   | <b>Part No.</b>                                                                                                                                                                | 381407 | <b>Ref. No.</b> — |
|                                                                                     | temperature probe Pt1000 probe -50 up to +110°C cable silicone°C probe ø5x20mm cable length 3m protection IP68                                                                 |        |                   |
|  | <b>Part No.</b>                                                                                                                                                                | 550802 | <b>Ref. No.</b> — |
|                                                                                     | PCB terminal block 4-pole raster size 5mm                                                                                                                                      |        |                   |
|  | <b>Part No.</b>                                                                                                                                                                | 550805 | <b>Ref. No.</b> — |
|                                                                                     | PCB terminal block 7-pole raster size 5mm                                                                                                                                      |        |                   |

## probes

## universal probes

## temperature probes



1

|                    |                                                                                                                                                  |                 |              |
|--------------------|--------------------------------------------------------------------------------------------------------------------------------------------------|-----------------|--------------|
| <b>Part No.</b>    | 381222                                                                                                                                           | <b>Ref. No.</b> | 418303463100 |
| <b>description</b> | temperature probe PTC 1kOhm cable silicone probe -50 up to +150°C cable -50 up to +180°C probe ø6x30mm cable length 3m cable colours grey 2-wire |                 |              |



1

|                    |                                                                                                                                 |                 |              |
|--------------------|---------------------------------------------------------------------------------------------------------------------------------|-----------------|--------------|
| <b>Part No.</b>    | 381221                                                                                                                          | <b>Ref. No.</b> | 418316740000 |
| <b>description</b> | temperature probe PTC 1kOhm cable silicone probe -50 up to +150°C cable -50 up to +180°C probe ø6x40mm cable length 1.5m 2-wire |                 |              |



## electronics

### PCBs



1

|                    |                                            |                 |              |
|--------------------|--------------------------------------------|-----------------|--------------|
| <b>Part No.</b>    | 360636                                     | <b>Ref. No.</b> | 418221547100 |
| <b>description</b> | PCB ON-OFF L 120mm W 40mm suitable for ISA |                 |              |

## keypads

### keypad units



1

|                    |                                             |                 |              |
|--------------------|---------------------------------------------|-----------------|--------------|
| <b>Part No.</b>    | 403576                                      | <b>Ref. No.</b> | 418294090000 |
| <b>description</b> | keypad PCB buttons 12 grey suitable for ISA |                 |              |

## compressors

### EMBRACO / ASPERA

#### R290A

#### LBP monophase

Lower evaporation temperature below -20°C



1

|                    |                                                                                                                                                                         |                 |              |
|--------------------|-------------------------------------------------------------------------------------------------------------------------------------------------------------------------|-----------------|--------------|
| <b>Part No.</b>    | 605202                                                                                                                                                                  | <b>Ref. No.</b> | 452500000000 |
| <b>description</b> | compressor coolant R290 type NT2170U 220-240V 50Hz LBP 17kg 3/4HP cylinder capacity 20.44cm <sup>3</sup> CSR H 220mm 544W 698W 883W 1097W 1340WWWWWW test method ASHRAE |                 |              |

#### R404a/R507

#### LBP monophase

Lower evaporation temperature below -20°C



1

|                    |                                                                                                                                                                                    |                 |              |
|--------------------|------------------------------------------------------------------------------------------------------------------------------------------------------------------------------------|-----------------|--------------|
| <b>Part No.</b>    | 605152                                                                                                                                                                             | <b>Ref. No.</b> | 452500001000 |
| <b>description</b> | compressor coolant R404a/R507 type NEK2134GK 220-240V 50Hz LBP 11kg 1/2HP cylinder capacity 8.77cm <sup>3</sup> CSIR H 180mm 227W 302W 394W 501W 621W 753WWWWWW test method ASHRAE |                 |              |



1

|                    |                                                                                                                                                                    |                 |              |
|--------------------|--------------------------------------------------------------------------------------------------------------------------------------------------------------------|-----------------|--------------|
| <b>Part No.</b>    | 605144                                                                                                                                                             | <b>Ref. No.</b> | 452400001000 |
| <b>description</b> | compressor coolant R404a/R507 type NEK2168GK 220-240V 50Hz LBP 22.9kg 3/4HP cylinder capacity 14.28cm <sup>3</sup> CSR H 200mm 345W 454W 587W 742W 921W 1123WWWWWW |                 |              |



1

|                    |                                                                                                                                                                       |                 |                              |
|--------------------|-----------------------------------------------------------------------------------------------------------------------------------------------------------------------|-----------------|------------------------------|
| <b>Part No.</b>    | 605174                                                                                                                                                                | <b>Ref. No.</b> | 452400055000<br>452452284000 |
| <b>description</b> | compressor coolant R404a/R507 type NJ2192GK 220-240V 50Hz LBP 20.4kg 1 1/4HP cylinder capacity 26.2cm <sup>3</sup> CSR H 265mm 685W 989W 1342W 1745W 2196W 2196WWWWWW |                 |                              |



|                                                                                   |                                                                                                                                                                                                                     |                 |                                              |
|-----------------------------------------------------------------------------------|---------------------------------------------------------------------------------------------------------------------------------------------------------------------------------------------------------------------|-----------------|----------------------------------------------|
|  |                                                                                                                                                                                                                     |                 |                                              |
| 1                                                                                 |                                                                                                                                                                                                                     |                 |                                              |
| <b>Part No.</b>                                                                   | 605081                                                                                                                                                                                                              | <b>Ref. No.</b> | 452447789000<br>452452285000<br>452452286000 |
| <b>description</b>                                                                | compressor coolant R404a/R507 type NJ2212GK 220-240V 50Hz LBP fully hermetic 21.5kg 1 1/2HP power input 1150W cylinder capacity 34cm <sup>3</sup> CSR H 277mm 880W 1269W 1738W 2289W 2921W 2921W test method ASHRAE |                 |                                              |

## HMBP monophase

High/Medium evaporation temperature above -20/-15 °C

|                                                                                    |                                                                                                                                                                                      |                 |              |
|------------------------------------------------------------------------------------|--------------------------------------------------------------------------------------------------------------------------------------------------------------------------------------|-----------------|--------------|
|  |                                                                                                                                                                                      |                 |              |
| 1                                                                                  |                                                                                                                                                                                      |                 |              |
| <b>Part No.</b>                                                                    | 605161                                                                                                                                                                               | <b>Ref. No.</b> | 452500003000 |
| <b>description</b>                                                                 | compressor coolant R404a/R507 type NEK6210GK 220-240V 50Hz HMBP fully hermetic 8.5kg 3/8HP cylinder capacity 8.78cm <sup>3</sup> CSIR H 200mmW 566W 674W 815W 988W 1195W 1435W 1707W |                 |              |

|                                                                                     |                                                                                                                                                                            |                 |              |
|-------------------------------------------------------------------------------------|----------------------------------------------------------------------------------------------------------------------------------------------------------------------------|-----------------|--------------|
|  |                                                                                                                                                                            |                 |              |
| 1                                                                                   |                                                                                                                                                                            |                 |              |
| <b>Part No.</b>                                                                     | 605177                                                                                                                                                                     | <b>Ref. No.</b> | 452447774000 |
| <b>description</b>                                                                  | compressor coolant R404a/R507 type NJ9238GK 220-240V 50Hz HMBP 22.1kg 1 1/2HP cylinder capacity 32.7cm <sup>3</sup> CSR H 277mmW 2016W 2640W 3315W 4045W 4830W 5668W 6560W |                 |              |

## fans

## refrigeration fans

## cold air circulating fans (complete)

## ELCO

|                                                                                     |                                                                                                  |                 |                   |
|-------------------------------------------------------------------------------------|--------------------------------------------------------------------------------------------------|-----------------|-------------------|
|   |                                                                                                  |                 |                   |
| 1                                                                                   |                                                                                                  |                 |                   |
| <b>Part No.</b>                                                                     | 602030                                                                                           | <b>Ref. No.</b> | 41812963100       |
| <b>description</b>                                                                  | fan fan wheel ø 100mm 230V 50-60Hz 10W 2500rpm connection Faston without fan wheel               |                 |                   |
| <b>spare parts for</b>                                                              | 602030                                                                                           |                 |                   |
|    | <b>Part No.</b>                                                                                  | 601563          | <b>Ref. No.</b> — |
|                                                                                     | fan wheel sucking ø 96mm shaft intake ø 4mm blade angle 26° W 18mm aluminium suitable for 601039 |                 |                   |
|    | <b>Part No.</b>                                                                                  | 601564          | <b>Ref. No.</b> — |
|                                                                                     | fan wheel blowing ø 96mm shaft intake ø 4mm blade angle 26° W 18mm aluminium suitable for 601056 |                 |                   |
| <b>accessories for</b>                                                              | 602030                                                                                           |                 |                   |
|  | <b>Part No.</b>                                                                                  | 602062          | <b>Ref. No.</b> — |
|                                                                                     | connector cable ELCO cable length 1500mm 0.75mm <sup>2</sup> protection IP44 for Plug-In         |                 |                   |

## miscellaneous

|                                                                                      |                                                                                                                                                               |                 |                                                                         |
|--------------------------------------------------------------------------------------|---------------------------------------------------------------------------------------------------------------------------------------------------------------|-----------------|-------------------------------------------------------------------------|
|  |                                                                                                                                                               |                 |                                                                         |
| 1                                                                                    |                                                                                                                                                               |                 |                                                                         |
| <b>Part No.</b>                                                                      | 601857                                                                                                                                                        | <b>Ref. No.</b> | 30413698<br>4152.0518<br>52A-20001/16<br>R400002486000<br>R400064297000 |
| <b>description</b>                                                                   | fan 230V 50/60Hz 15W ø 96mm type 52A-20001/16 2500rpm blowing fan wheel ø 96mm cable length 3000mm connection with cable mounting ø 110mm built-in depth 98mm |                 |                                                                         |



## equipment-specific units

### for refrigerated counters

#### lid hinges



1

|                    |                                                         |                 |              |
|--------------------|---------------------------------------------------------|-----------------|--------------|
| <b>Part No.</b>    | 696667                                                  | <b>Ref. No.</b> | 442700041005 |
| <b>description</b> | bracket aluminium for hinge for door mounting pos. left |                 |              |



1

|                    |                                                         |                 |              |
|--------------------|---------------------------------------------------------|-----------------|--------------|
| <b>Part No.</b>    | 696668                                                  | <b>Ref. No.</b> | 442700042005 |
| <b>description</b> | bracket aluminium for hinge for door mounting pos. left |                 |              |



1

|                    |                                                          |                 |              |
|--------------------|----------------------------------------------------------|-----------------|--------------|
| <b>Part No.</b>    | 696665                                                   | <b>Ref. No.</b> | 442700044005 |
| <b>description</b> | bracket aluminium for hinge for door mounting pos. right |                 |              |



1

|                    |                                                          |                 |              |
|--------------------|----------------------------------------------------------|-----------------|--------------|
| <b>Part No.</b>    | 696666                                                   | <b>Ref. No.</b> | 442700043005 |
| <b>description</b> | bracket aluminium for hinge for door mounting pos. right |                 |              |

## handles and hand wheels

### bracket handles



1

|                    |                                                                                |                 |              |
|--------------------|--------------------------------------------------------------------------------|-----------------|--------------|
| <b>Part No.</b>    | 701479                                                                         | <b>Ref. No.</b> | 491094841000 |
| <b>description</b> | pull handle L1 320mm L2 230mm H 43mm mounting distance 275mm W 30mm grey/white |                 |              |

## locks

### snap locks

#### producer-specific

#### ISA



1

|                    |                                                                              |                 |             |
|--------------------|------------------------------------------------------------------------------|-----------------|-------------|
| <b>Part No.</b>    | 692857                                                                       | <b>Ref. No.</b> | 50230200300 |
| <b>description</b> | snap lock L 82mm W 38mm H 35mm mounting distance 27mm spring thickness 1.6mm |                 |             |

## hinges

### edgemount hinges

#### miscellaneous



1

|                    |                                                                                                                                                |                 |             |
|--------------------|------------------------------------------------------------------------------------------------------------------------------------------------|-----------------|-------------|
| <b>Part No.</b>    | 692599                                                                                                                                         | <b>Ref. No.</b> | 50230102300 |
| <b>description</b> | edgemount hinge L 102mm W 19mm mounting distance 62mm hinging left/right without lift plastic grey refrigeration units centre of rotation 24mm |                 |             |



## spring assisted hinges

universal

INTERKLIMAT

hinges



1

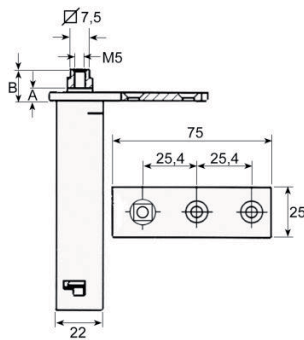

|                 |        |                 |       |
|-----------------|--------|-----------------|-------|
| <b>Part No.</b> | 690622 | <b>Ref. No.</b> | 24563 |
|-----------------|--------|-----------------|-------|

|                    |                                                                                                                                                                |
|--------------------|----------------------------------------------------------------------------------------------------------------------------------------------------------------|
| <b>description</b> | spring assisted hinge series 28L mounting pos. left/right L 75mm W 25mm H 103mm A 13mm B 18mm mounting measurements 22x22mm intake 7.5x7.5 refrigeration units |
|--------------------|----------------------------------------------------------------------------------------------------------------------------------------------------------------|

## producer-specific

ISA



1

|                 |        |                 |       |
|-----------------|--------|-----------------|-------|
| <b>Part No.</b> | 692600 | <b>Ref. No.</b> | 24563 |
|-----------------|--------|-----------------|-------|

|                    |                                                                                                   |
|--------------------|---------------------------------------------------------------------------------------------------|
| <b>description</b> | spring assisted hinge right/left L 73mm W 24mm H 100mm refrigeration units mounting distance 26mm |
|--------------------|---------------------------------------------------------------------------------------------------|

## door bearing

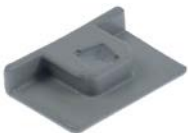

1

|                 |        |                 |              |
|-----------------|--------|-----------------|--------------|
| <b>Part No.</b> | 692601 | <b>Ref. No.</b> | 442700045005 |
|-----------------|--------|-----------------|--------------|

|                    |                                                             |
|--------------------|-------------------------------------------------------------|
| <b>description</b> | hinge L 40mm W 25mm mounting pos. bottom left thickness 7mm |
|--------------------|-------------------------------------------------------------|



1

|                    |                                                                        |                 |              |
|--------------------|------------------------------------------------------------------------|-----------------|--------------|
| <b>Part No.</b>    | 692598                                                                 | <b>Ref. No.</b> | 442700040005 |
| <b>description</b> | hinge L 40mm W 25mm mounting pos. bottom right thickness 7mm Qty 1 pcs |                 |              |

## gaskets

## refrigeration gaskets

## plug-in gaskets

## profile 9048

We offer custom-made gaskets for this profile

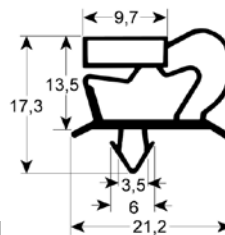

1

|                 |        |                 |             |
|-----------------|--------|-----------------|-------------|
| <b>Part No.</b> | 901619 | <b>Ref. No.</b> | 42403329900 |
|-----------------|--------|-----------------|-------------|

|                    |                                                              |
|--------------------|--------------------------------------------------------------|
| <b>description</b> | refrigeration gasket profile 9048 W 675mm L 1535mm plug size |
|--------------------|--------------------------------------------------------------|

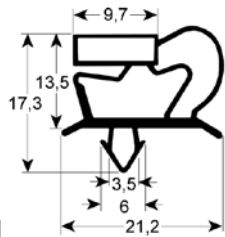

1

|                 |        |                 |     |
|-----------------|--------|-----------------|-----|
| <b>Part No.</b> | 902258 | <b>Ref. No.</b> | N/A |
|-----------------|--------|-----------------|-----|

|                    |                                                |
|--------------------|------------------------------------------------|
| <b>description</b> | refrigeration gasket profile 9048 Wmm L 2500mm |
|--------------------|------------------------------------------------|

## profile 9703

We offer custom-made gaskets for this profile

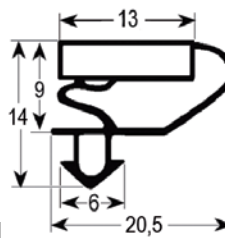

1

|                 |        |                 |       |
|-----------------|--------|-----------------|-------|
| <b>Part No.</b> | 970884 | <b>Ref. No.</b> | 29013 |
|-----------------|--------|-----------------|-------|

|                    |                                                             |
|--------------------|-------------------------------------------------------------|
| <b>description</b> | refrigeration gasket profile 9703 W 172mm L 426mm plug size |
|--------------------|-------------------------------------------------------------|



|                    |                                                             |                 |       |
|--------------------|-------------------------------------------------------------|-----------------|-------|
| <b>Part No.</b>    | 970819                                                      | <b>Ref. No.</b> | 29011 |
| <b>description</b> | refrigeration gasket profile 9703 W 281mm L 424mm plug size |                 |       |

|                    |                                                             |                 |       |
|--------------------|-------------------------------------------------------------|-----------------|-------|
| <b>Part No.</b>    | 970885                                                      | <b>Ref. No.</b> | 29014 |
| <b>description</b> | refrigeration gasket profile 9703 W 390mm L 424mm plug size |                 |       |

|                    |                                                                                             |                 |                |
|--------------------|---------------------------------------------------------------------------------------------|-----------------|----------------|
| <b>Part No.</b>    | 900933                                                                                      | <b>Ref. No.</b> | 29012<br>30546 |
| <b>description</b> | refrigeration gasket profile 9703 W 436mm L 616mm plug size L1 606mm W1 426mm external size |                 |                |

|                    |                                                                                               |                 |              |
|--------------------|-----------------------------------------------------------------------------------------------|-----------------|--------------|
| <b>Part No.</b>    | 901058                                                                                        | <b>Ref. No.</b> | 424019211000 |
| <b>description</b> | refrigeration gasket profile 9703 W 632mm L 1320mm plug size L1 1314mm W1 626mm external size |                 |              |

|                    |                                                              |                 |     |
|--------------------|--------------------------------------------------------------|-----------------|-----|
| <b>Part No.</b>    | 901056                                                       | <b>Ref. No.</b> | N/A |
| <b>description</b> | refrigeration gasket profile 9703 W 685mm L 1560mm plug size |                 |     |

|                    |                                                             |                 |       |
|--------------------|-------------------------------------------------------------|-----------------|-------|
| <b>Part No.</b>    | 901057                                                      | <b>Ref. No.</b> | 29010 |
| <b>description</b> | refrigeration gasket profile 9703 W 685mm L 756mm plug size |                 |       |

|                    |                                                             |                 |              |
|--------------------|-------------------------------------------------------------|-----------------|--------------|
| <b>Part No.</b>    | 901668                                                      | <b>Ref. No.</b> | 424000017000 |
| <b>description</b> | refrigeration gasket profile 9703 W 755mm L 910mm plug size |                 |              |

**profile 9704**

We offer custom-made gaskets for this profile

|                    |                                                                              |                 |       |
|--------------------|------------------------------------------------------------------------------|-----------------|-------|
| <b>Part No.</b>    | 901978                                                                       | <b>Ref. No.</b> | 29015 |
| <b>description</b> | refrigeration gasket profile 9704 W 398mm L 278mm plug size equiv. no. 29015 |                 |       |

|                    |                                                                                             |                 |       |
|--------------------|---------------------------------------------------------------------------------------------|-----------------|-------|
| <b>Part No.</b>    | 901680                                                                                      | <b>Ref. No.</b> | 29017 |
| <b>description</b> | refrigeration gasket profile 9704 W 525mm L 615mm plug size L1 606mm W1 516mm external size |                 |       |

|                    |                                                                                                                |                 |       |
|--------------------|----------------------------------------------------------------------------------------------------------------|-----------------|-------|
| <b>Part No.</b>    | 901976                                                                                                         | <b>Ref. No.</b> | 29009 |
| <b>description</b> | refrigeration gasket profile 9704 W 689mm L 1565mm plug size L1 1555mm W1 675mm external size suitable for ISA |                 |       |





|                    |                                                |                 |     |
|--------------------|------------------------------------------------|-----------------|-----|
| <b>Part No.</b>    | 902299                                         | <b>Ref. No.</b> | N/A |
| <b>description</b> | refrigeration gasket profile 9704 Wmm L 2500mm |                 |     |

profile 9753

We offer custom-made gaskets for this profile

|                    |                                                |                 |     |
|--------------------|------------------------------------------------|-----------------|-----|
| <b>Part No.</b>    | 900875                                         | <b>Ref. No.</b> | N/A |
| <b>description</b> | refrigeration gasket profile 9753 Wmm L 2500mm |                 |     |

profile 9333

We offer custom-made gaskets for this profile

|                    |                                                              |                 |     |
|--------------------|--------------------------------------------------------------|-----------------|-----|
| <b>Part No.</b>    | 900992                                                       | <b>Ref. No.</b> | N/A |
| <b>description</b> | refrigeration gasket profile 9333 W 612mm L 1457mm plug size |                 |     |

|                    |                                                |                 |     |
|--------------------|------------------------------------------------|-----------------|-----|
| <b>Part No.</b>    | 902167                                         | <b>Ref. No.</b> | N/A |
| <b>description</b> | refrigeration gasket profile 9333 Wmm L 2500mm |                 |     |

profile 9012

We offer custom-made gaskets for this profile

|                    |                                                              |                 |          |
|--------------------|--------------------------------------------------------------|-----------------|----------|
| <b>Part No.</b>    | 901620                                                       | <b>Ref. No.</b> | 28047721 |
| <b>description</b> | refrigeration gasket profile 9012 W 625mm L 1595mm plug size |                 |          |

screw-in gaskets

profile 9106

We offer custom-made gaskets for this profile

|                    |                                                |                 |     |
|--------------------|------------------------------------------------|-----------------|-----|
| <b>Part No.</b>    | 902262                                         | <b>Ref. No.</b> | N/A |
| <b>description</b> | refrigeration gasket profile 9106 Wmm L 2500mm |                 |     |

O-rings

EPDM

|                    |                                                     |                 |       |
|--------------------|-----------------------------------------------------|-----------------|-------|
| <b>Part No.</b>    | 528632                                              | <b>Ref. No.</b> | 18025 |
| <b>description</b> | O-ring EPDM thickness 3.53mm ID ø 44.04mm Qty 1 pcs |                 |       |





## refrigeration cycle components

### valves

#### reversing valves



1

|                                                                                   |                                                                                                                                                                                            |                 |                             |
|-----------------------------------------------------------------------------------|--------------------------------------------------------------------------------------------------------------------------------------------------------------------------------------------|-----------------|-----------------------------|
| <b>Part No.</b>                                                                   | 370791                                                                                                                                                                                     | <b>Ref. No.</b> | 50600401200                 |
| <b>description</b>                                                                | reversing valve 4-way RANCO type V2-408060200 inlet 1/2" (12.84mm) outlet 3/8" (9.67mm) power range (R407C) 2.81-6.33 kW power range (R410A) 3.17-7.74 kW power range (R134A) 2.46-4.92 kW |                 |                             |
| <b>accessories for</b>                                                            | 370791                                                                                                                                                                                     |                 |                             |
|  | <b>Part No.</b>                                                                                                                                                                            | 371302          | <b>Ref. No.</b> 50504200500 |
|                                                                                   | solenoid coil RANCO model LDK-41 230 50/60Hz 5/4W cable length 1200mm green                                                                                                                |                 |                             |
|  | <b>Part No.</b>                                                                                                                                                                            | 371306          | <b>Ref. No.</b> —           |
|                                                                                   | solenoid coil RANCO model LDK-41 208/240VAC 50/60Hz 5/4W cable length 2000mm                                                                                                               |                 |                             |

#### spare parts and accessories



1

|                    |                                                                             |                 |             |
|--------------------|-----------------------------------------------------------------------------|-----------------|-------------|
| <b>Part No.</b>    | 371302 <sup>1</sup>                                                         | <b>Ref. No.</b> | 50504200500 |
| <b>description</b> | solenoid coil RANCO model LDK-41 230 50/60Hz 5/4W cable length 1200mm green |                 |             |

<sup>1</sup>incl. cable 1200mm

## evaporators

### for fridges

#### producer-specific



1

|                    |                                                                                 |                 |              |
|--------------------|---------------------------------------------------------------------------------|-----------------|--------------|
| <b>Part No.</b>    | 750590                                                                          | <b>Ref. No.</b> | 420081399000 |
| <b>description</b> | evaporator L 345mm W 120mm D 280mm total length 390mm suitable for ISA-TASSELLI |                 |              |



1

|                    |                                                     |                 |              |
|--------------------|-----------------------------------------------------|-----------------|--------------|
| <b>Part No.</b>    | 750544                                              | <b>Ref. No.</b> | 420181938000 |
| <b>description</b> | evaporator L 390mm W 355mm H 100mm suitable for ISA |                 |              |

## evaporation and condensing trays

### unheated condensing trays



1

|                    |                                                |                 |              |
|--------------------|------------------------------------------------|-----------------|--------------|
| <b>Part No.</b>    | 750542                                         | <b>Ref. No.</b> | 442254412000 |
| <b>description</b> | condensing tray L 400mm W 290mm H 88mm plastic |                 |              |



1

|                    |                                                |                 |              |
|--------------------|------------------------------------------------|-----------------|--------------|
| <b>Part No.</b>    | 750541                                         | <b>Ref. No.</b> | 442241872100 |
| <b>description</b> | condensing tray L 475mm W 265mm H 90mm plastic |                 |              |

**GASTRO**PARTS.COM

