



GASTROPARTS

Intimpex

[EN] Equipment

[DE] Geräte

[ES] Aparatos

[FR] Équipement

[IT] Attrezzature

[PL] Urządzenia

[RU] Оборудование

✉ gastroparts@gastroparts.com

☎ +48 56 657 00 66

📘 fb.com/gastroparts.global

GASTROPARTS.COM





thermostats

refrigeration thermostats

RANCO

K22 series

RANCO



1

Part No.	390345	Ref. No.	1006
description	thermostat RANCO type K22L1034 probe ømm probe Lmm capillary pipe 2000mm T war -13.5°C T cold -20.5°C		

K36 series

RANCO



1

Part No.	390342	Ref. No.	0901
description	thermostat RANCO type K36L7257 capillary pipe 450mm probe ø6.5x110mm		

K50 series

RANCO



1

Part No.	390340	Ref. No.	1068
description	thermostat RANCO type K50L3209 probe ømm probe Lmm capillary pipe 2000mm		

RANCO



1

Part No.	390341	Ref. No.	0876
description	thermostat RANCO type K50-L3251 capillary pipe 2000mm		

K61 series

RANCO



1

Part No.	390344	Ref. No.	0950
description	thermostat RANCO type K61L1505 probe ømm probe Lmm capillary pipe 1500mm		

switches and momentary switches

rocker/momentary rocker switches

30x22mm



1

Part No.	345356	Ref. No.	1050
description	momentary rocker switch mounting measurements 30x22mm white 1CO 250V 16A connection male faston 6.3mm ambient temperature max. 125/55°C protection IP40		

relays

power relays

with male contacts

bullet connectors, 8 contacts



1

Part No.	380343	Ref. No.	1056
description	time relay CET 220VACA 1CO connection plug-in connection round 8-pole KF00		

relay sockets

1

Part No.	380344	Ref. No.	1060
description	relay socket 8-pole		



1

Part No.	380638	Ref. No.	1060
description	relay socket 8-pole dimensions 51x41x23mm 250V 10A FINDER manuf. no. 90.26		

solenoïd valves

solenoïd valves (refrigeration)

PARKER

valve bodies



1

Part No.	370148	Ref. No.	3122
description	solenoid valve body NC PARKER type VE-115L p max 35bar DN 8mm -40 up to +105°C refrigeration		

various

valve bodies



1

Part No.	370146	Ref. No.	2657
description	solenoid valve body angled DN 1.9mm refrigeration		



1

Part No.	370147	Ref. No.	3059
description	solenoid valve body angled DN 2.5mm refrigeration		

pressure switches

for refrigeration

SAGI NO MIYA



1

Part No.	541114	Ref. No.	3416
description	pressure control reset automatic refrigeration connection male faston 6.3mm switch-on pressure 10bar		

fans

refrigeration fans

refrigeration motors universal

accessories

fan wheels

aluminium



1

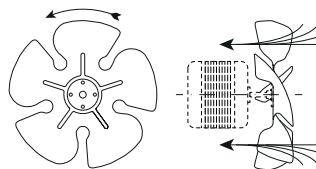

Part No.	601387	Ref. No.	0527
description	fan wheel sucking \varnothing 254mm fan wheel mounting 25.4mm blade angle 34° W 50mm aluminium		



motors

motors

for ice-cube maker

complete

1

Part No.	601141	Ref. No.	6029
description	motor type S280		

universal



1

Part No.	601140	Ref. No.	6028
description	motor 180W 230V 50Hz 1 phase shaft ø 11mm 1400rpm type MDE63C4 ø 120mm H 170mm L 190mm fixing dimensions 80x100mm CARPANELLI 0.18kW		

1

Part No.	601141	Ref. No.	6029
description	motor type S280		

equipment-specific units

for ice-cube maker

drain systems

overflow pipes



1

Part No.	695149	Ref. No.	2337
description	overflow pipe for ice maker tube ø 12mm pipe length 33.5mm		

gearboxes



1

Part No.	601143	Ref. No.	2622
description	gearbox transmission I=60 type S150		



1

Part No.	601144	Ref. No.	3190
description	gearbox transmission I=68 type S280		

spray systems

FAG/INTEMPEX

spray arms

1

Part No.	695124	Ref. No.	2490
description	spray arm for ice maker		



1			
Part No.	695120	Ref. No.	2278
description	spray arm L 270mm nozzles 4 for ice maker		
spare parts for	695120		
	Part No.	695126	Ref. No. 0776
	end cap for spray arm insertion size 13x13mm		

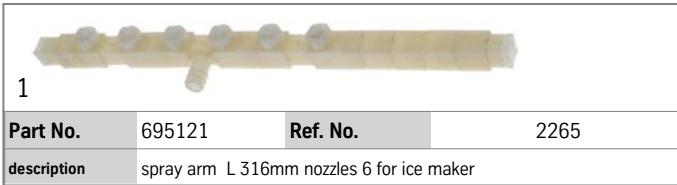

1			
Part No.	695121	Ref. No.	2265
description	spray arm L 316mm nozzles 6 for ice maker		

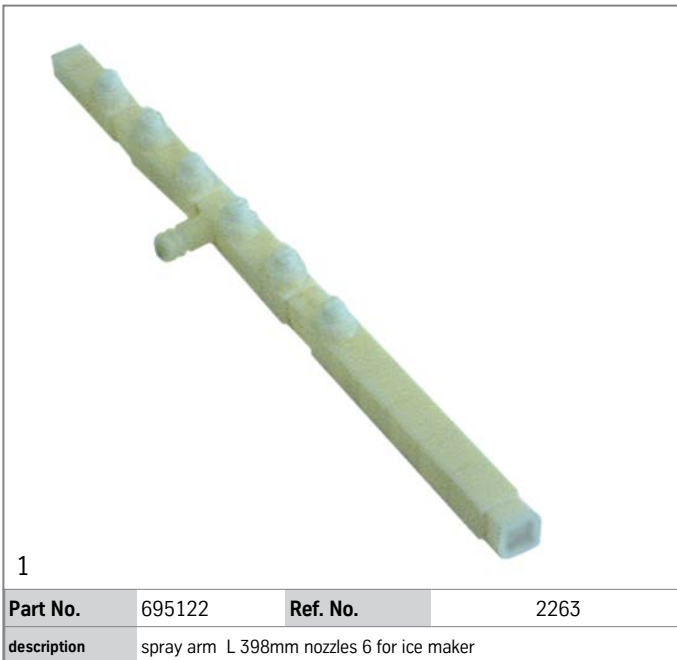

1			
Part No.	695122	Ref. No.	2263
description	spray arm L 398mm nozzles 6 for ice maker		



1			
Part No.	695123	Ref. No.	2264
description	spray arm L 398mm nozzles 8 for ice maker		

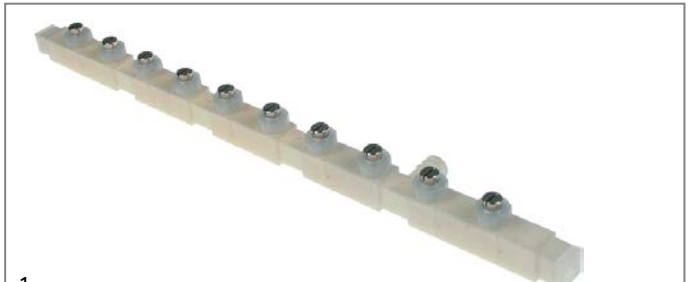

1			
Part No.	695412	Ref. No.	2285
description	spray arm L 467mm nozzles 10 for ice maker		

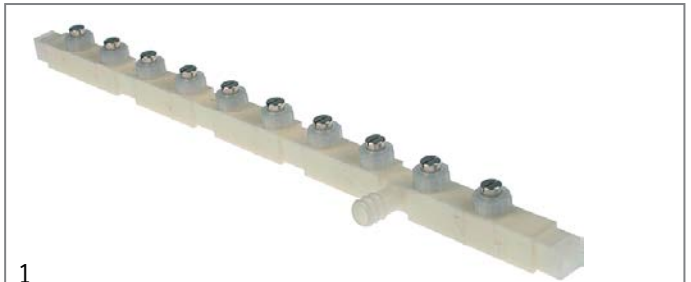

1			
Part No.	695413	Ref. No.	2286
description	spray arm L 467mm nozzles 10 for ice maker		

1

Part No.	695174	Ref. No.	4710
description	spray arm L 600mm nozzles 13 for ice maker		



1

Part No.	695125	Ref. No.	2267
description	spray arm L 605mm nozzles 13 for ice maker		

accessories



1

Part No.	695126	Ref. No.	0776
description	end cap for spray arm insertion size 13x13mm		



1

Part No.	695127	Ref. No.	2495
description	spray nozzle for ice maker		



1

Part No.	695128	Ref. No.	2452
description	union nut for nozzle		

doors



1

Part No.	695157	Ref. No.	3569
description	flap for ice-cube maker		



1

Part No.	695158	Ref. No.	3652
description	flap for ice-cube maker		



1

Part No.	695160	Ref. No.	4246
description	flap for ice-cube maker		

curtains

with holder



1

Part No.	695175	Ref. No.	2200
description	curtain for ice maker W 620mm H 165mm with holder shaft length 620mm shaft ø 6mm		



1



Part No.	695611	Ref. No.	3314
-----------------	--------	-----------------	------

description	curtain for ice-cube maker
--------------------	----------------------------

without holder

1



Part No.	695151	Ref. No.	1370
-----------------	--------	-----------------	------

description	curtain for ice maker W 230mm H 115mm shaft length 260mm shaft ø 6mm
--------------------	--

1



Part No.	695152	Ref. No.	1371
-----------------	--------	-----------------	------

description	curtain for ice maker W 275mm H 115mm shaft length 303mm shaft ø 6mm
--------------------	--

1



Part No.	695153	Ref. No.	2026
-----------------	--------	-----------------	------

description	curtain for ice maker W 355mm H 115mm shaft length 380mm shaft ø 6mm
--------------------	--

mechanics for evaporators

gear motors

motors

1



Part No.	601140	Ref. No.	6028
-----------------	--------	-----------------	------

description	motor 180W 230V 50Hz 1 phase shaft ø 11mm 1400rpm type MDE63C4 ø 120mm H 170mm L 190mm fixing dimensions 80x100mm CARPANELLI 0.18kW
--------------------	---

hoses

formed hoses

form S

1



Part No.	695130	Ref. No.	2255
-----------------	--------	-----------------	------

description	formed hose S-shape for ice-cube maker ID ø 14mm ED ø 20mm L 160mm W 100mm
--------------------	--

1



Part No.	695134	Ref. No.	2262
-----------------	--------	-----------------	------

description	formed hose S-shape insulated for ice-cube maker ID ø 14/19mm ED ø 19/24mm L 225mm W 45mm
--------------------	---

1



Part No.	695161	Ref. No.	2269
-----------------	--------	-----------------	------

description	supply hose for evaporator
--------------------	----------------------------

1



Part No.	695162	Ref. No.	2470
-----------------	--------	-----------------	------

description	supply hose for evaporator
--------------------	----------------------------

miscellaneous

1



Part No.	695131	Ref. No.	2470
-----------------	--------	-----------------	------

description	formed hose for ice-cube maker ID ø 15mm ED ø 18mm L 120mm W 80mm
--------------------	---

1

Part No.	695132	Ref. No.	2475
description	formed hose for ice-cube maker ID ø 15mm ED ø 18mm L 150mm W 85mm		



1

Part No.	695139	Ref. No.	2472
description	formed hose for ice-cube maker ID ø 15mm ED ø 19mm L 160mm W 100mm		



1

Part No.	695141	Ref. No.	2253
description	formed hose for ice-cube maker ID ø 15mm ED ø 19mm L 350mm W 90mm		



1

Part No.	695142	Ref. No.	3378
description	formed hose for ice-cube maker ID ø 16/20mm ED ø 20/23mm L 540mm W 75mm		

floats

float containers

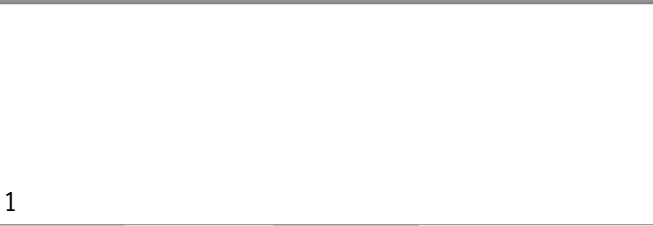

1

Part No.	695165	Ref. No.	4186
description	float container for ice-cube maker complete		

1

Part No.	695166	Ref. No.	4187
description	float container for ice-cube maker complete		

for ice crusher

V-belts



1

Part No.	695171	Ref. No.	2580
description	V-belt pulley single disc ø 100mm shaft intake ø 11mm groove depth 13mm disc width 16mm groove width 5mm overall width 26mm aluminium		



1

Part No.	695172	Ref. No.	3023
description	V-belt pulley single disc ø 100mm shaft intake ø 16mm groove depth 13mm disc width 16mm groove width 5mm overall width 26mm aluminium		



1

Part No.	695170	Ref. No.	3244
description	V-belt pulley single disc ø 60mm shaft intake ø 11mm groove depth 13mm disc width 16mm groove width 5mm overall width 26mm aluminium		



1

Part No.	695173	Ref. No.	3245
description	V-belt pulley single disc \varnothing 60mm shaft intake \varnothing 14mm groove depth 13mm disc width 16mm groove width 5mm overall width 26mm aluminium shaft \varnothing 14mm		

evaporators

for ice-cube maker

for ice cube maker



1

Part No.	750180	Ref. No.	3084
description	evaporator for ice-cube maker 104 cubes L 600mm W 425mm H 45mm D110/CP120		

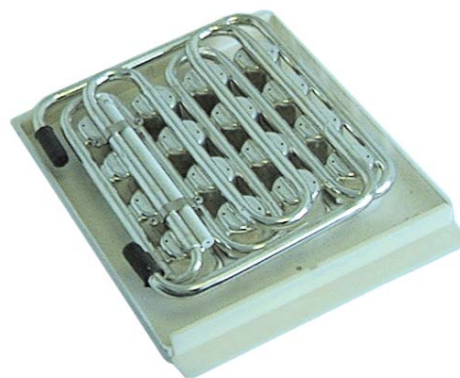

1

Part No.	750134	Ref. No.	4143
description	evaporator for ice-cube maker 16 cubes L 275mm W 212mm H 45mm D22/CP22		



1

Part No.	750135	Ref. No.	4263
description	evaporator for ice-cube maker 24 cubes L 314mm W 212mm H 45mm D27/CP30SC		



1

Part No.	750136	Ref. No.	4263 CP30E
description	evaporator for ice-cube maker 24 cubes L 398mm W 213mm H 45mm D31/CP30		



			
1			
Part No.	750139	Ref. No.	3009
description	evaporator for ice-cube maker 52 cubes L 600mm W 213mm H 45mm D71/CP70		

for flake ice maker			
1			
Part No.	750130	Ref. No.	4190
description	evaporator		

1			
Part No.	750132	Ref. No.	2680
description	evaporator complete		

			
1			
Part No.	750131	Ref. No.	3254
description	evaporator for flake ice maker S80/ITS80 W 175mm H 320mm ø 98mm with auger complete		

			
1			
Part No.	750133	Ref. No.	3255
description	evaporator for flake ice maker W 220mm H 420mm ø 105mm with auger complete		

transmission technology and ball bearings

drive belts

V-belts

profile A/13

			
1			
Part No.	695164	Ref. No.	2659
description	V-belt belt width 13mm L 730mm H 8mm CODE A29 profile A/13		

GASTROPARTS.COM

