



GASTROPARTS

Inoksan

- [EN]** Equipment
- [DE]** Geräte
- [ES]** Aparatos
- [FR]** Équipement
- [IT]** Attrezzature
- [PL]** Urządzenia
- [RU]** Оборудование

✉ gastroparts@gastroparts.com

☎ +48 56 657 00 66

📘 fb.com/gastroparts.global

GASTROPARTS.COM





heating elements

heating elements for fryers

Part No.	415377	Ref. No.	10070020
description	heating element 5500W 230V heating circuits 1 L 320mm W 86mm H 248mm rectangular flange connection M5 immersion heater W1 19mm W2 48mm H1 213mm H2 38mm hole distance 40mm hole ø 6mm flange length 60mm flange width 30mm tube ø 8.5mm connection length 26mm		

Part No.	416868	Ref. No.	22317025
description	heating element 1500W 230V heating circuits 1 L 530mm W 225mm lug length 35mm lug width 14mm hole distance 190mm connection M4 tube ø 8.5mm bracket mounting thread M5 mounting pos. lower dry heating element		

Part No.	416869	Ref. No.	22317022
description	heating element 500W 220V L 565mm W 58mm flange length 70mm flange width 14mm connection length 62mm connection M4 tube ø 6.5mm heating circuits 1 rectangular flange with thread bolt mounting thread M5 dry heating element		

Part No.	416865	Ref. No.	22207023
description	heating element 1500W 230V L 485mm W 360mm thread M12 mounting distance 345mm connection length 55mm connection M4 tube ø 8.5mm heating circuits 1 dry heating element mounting pos. upper 2 hole fixing pizza oven		

heating elements for griddles

Part No.	416862	Ref. No.	24307022
description	heating element 600W 230V heating circuits 1 L 394mm tube ø 6.5mm bracket mounting connection male faston 6.3mm hole ø M5mm dry heating element lug length 32mm lug width 17mm		

heating elements for hot dog machines

Part No.	416863	Ref. No.	24207022
description	heating element 1500W 230V L 232mm W 161mm tube ø 6.5mm connection M4 connection distance 155mm dry heating element heating circuits 1 hot dog machine		

Part No.	416866	Ref. No.	22207024
description	heating element 2250W 230V L 485mm W 410mm thread 1/4" mounting distance 405mm connection M4 tube ø 8.5mm heating circuits 1 dry heating element mounting pos. centre/bottom 2 hole fixing		

heating elements for pizza ovens

Part No.	416867	Ref. No.	22317026
description	heating element 1000W 230V heating circuits 1 L 530mm W 220mm lug length 35mm lug width 114mm hole distance 170mm connection M4 tube ø 8.5mm rectangular flange mounting pos. upper hole ø M5mm dry heating element pizza oven		

heating elements for salamanders/toast-

Part No.	416870	Ref. No.	24507022
description	heating element 1750W 230V heating circuits 1 L 282mm W 257mm L1 28mm L2 254mm W1 115mm W2 30mm flange length 70mm flange width 22mm hole distance 57mm tube ø 6.3mm dry heating element connection M4 rectangular flange hole ø M4mm H 6.3mm		



1			
Part No.	416869	Ref. No.	22317022
description	heating element 500W 220V L 565mm W 58mm flange length 70mm flange width 14mm connection length 62mm connection M4 tube ø 6.5mm heating circuits 1 rectangular flange with thread bolt mounting thread M5 dry heating element		

1			
Part No.	416860	Ref. No.	24407022
description	heating element 500W 230V heating circuits 1 L 295mm W 47mm flange length 60mm flange width 20mm connection male faston 6.3mm connection length 50mm tube ø 6.5mm rectangular flange dry heating element for toaster H 6.5mm		

quartz heating elements

1			
Part No.	416861	Ref. No.	24417022
description	quartz heating element 290W L 335mm ø 10mm connection male faston 6.3mm dry heating element		

radiation heaters

1			
Part No.	490204	Ref. No.	24017570
description	radiation heater rectangular 600W 230V L 150mm W 130mm connections 2		

1			
Part No.	490142	Ref. No.	24017550
description	radiation heater rectangular 750W 230V L 151mm W 133mm connections 2		

HEATING ELEMENTS/HOT PLATES INOKSAN

hot plates

square & rectangular

with radiused edge



1			
Part No.	490056 ¹	Ref. No.	10071300
description	hot plate dimensions 300x300mm 3000W 230V with spill ring connection 4 screw clamps protector yes square		

¹incl. protector



1			
Part No.	490177	Ref. No.	10071303
description	hot plate dimensions 300x300mm 3000W 440V with spill ring connection 4 screw clamps protector no		

round

with radiused edge

for domestic and commercial kitchens

1			
Part No.	416864	Ref. No.	10071151
description	hot plate 1500W 230V		



1			
Part No.	490012	Ref. No.	10071151
description	hot plate ø 145mm 1500W 230V connection 4 screw clamps with 8mm spill ring		



energy regulators

EGO

1-circuit



Part No.	380015	Ref. No.	10091000
description	energy regulator 230V 13A single-circuit turn direction right shaft ø 6x4.6mm shaft L 23mm mounting thread M4 power release 6-100% no. 50.57021.010		

thermostats

bi-metal thermostats

safety bi-metal thermostats



Part No.	375673	Ref. No.	10100100
description	bi-metal safety thermostat hole distance 22mm 1NC 1-pole		

control and safety thermostats

EGO

control thermostats

55.17_ series



Part No.	375672	Ref. No.	10100004
description	thermostat t.max. 320°C temperature range 50-320°C 1-pole 1NO 16A probe ø 3.03mm probe L 178mm capillary pipe 840mm capillary pipe isolatedmm gland nut shaft ø 6x4.6mm shaft L 23mm shaft position upper rotation 270°		

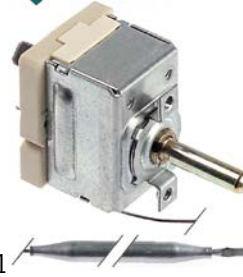

Part No.	375674	Ref. No.	10100003
description	thermostat t.max. 85°C temperature range 30-85°C 1-pole 1NO 16A probe ø 6mm probe L 94mm capillary pipe 840mm capillary pipe isolatedmm gland nut shaft ø 6x4.6mm shaft L 23mm shaft position upper rotation 270°		

55.34_ series

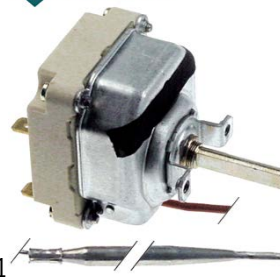

Part No.	375424	Ref. No.	10100005
description	thermostat t.max. 320°C temperature range 60-320°C 3-pole 3NO 16A probe ø 4mm probe L 128mm capillary pipe 1800mm capillary pipe isolated 1300mm gland nut shaft ø 6x4.6mm shaft L 23mm shaft position upper rotation 270°		



Part No.	375027	Ref. No.	10100002
description	thermostat t.max. 470°C temperature range 50-470°C 3-pole 3NO 16A probe ø 3.9mm probe L 308mm capillary pipe 990mm capillary pipe isolated 800mm gland nut shaft ø 6x4.6mm shaft L 23mm shaft position upper rotation 270°		



safety thermostats

55.32_ series

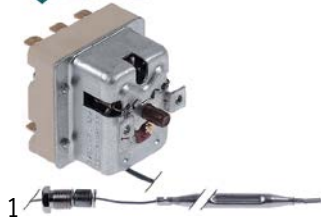

Part No.	375393	Ref. No.	10100051
description	safety thermostat switch-off temp. 235°C 3-pole 1CO/2NC 20A probe ø 6mm probe L 87mm capillary pipe 1790mm capillary pipe isolated 1710mm gland nut M9x1 probe SS		

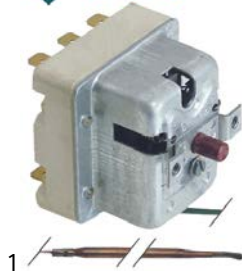

Part No.	375257	Ref. No.	10100001
description	safety thermostat switch-off temp. 580°C 3-pole 20A probe ø 4mm probe L 163mm capillary pipe 1200mm capillary pipe isolatedmm gland nut probe		

switches and momentary switches

rocker/momentary rocker switches

30x11mm



Part No.	346400	Ref. No.	10010207
description	rocker switch mounting measurements 30x11mm black 1CO 250V 16A with neutral position I O II connection male faston 6.3mm ambient temperature max. 85°C/145°C protection IP65 with cover cap		

accessories for 346400



Part No.	301035	Ref. No.	—
description	protective cover mounting measurements 30x11mm		

30x22mm

blank



Part No.	301005	Ref. No.	10010200
description	rocker switch mounting measurements 30x22mm red 2NO 250V 16A illuminated connection male faston 6.3mm ambient temperature max. 125/55°C protection IP65 with protecting cover		

accessories for 301005



Part No.	301036	Ref. No.	—
description	protective cover internal size 30x22mm for rocker switch mounting measurementsmm		

push/momentary push switches

ø22.3mm



Part No.	346402	Ref. No.	10010113
description	momentary push switch mounting ø 22.3mm red 1NC 250V 10A connection screw ambient temperature max. 85°C protection IP40		



Part No.	346401	Ref. No.	10010112
description	push switch mounting ø 22.3mm green 1NO 250V 10A connection screw ambient temperature max. 85°C protection IP40		

cam switches

on/off



Part No.	300021	Ref. No.	10010304
description	cam switch 4 operating positions 4NO sequence 0-1-0-1 16A shaft ø 6x4.6mm shaft L 23mm connection screw ceramic		

4-position





Part No.	300022	Ref. No.	10010303
description	cam switch 4 operating positions 2CO sequence 0-1-2-3 16A shaft ø 6x4.6mm shaft L 23mm connection screw		



7-position



1

Part No.	300025	Ref. No.	10010302
description	cam switch 7 operating positions 1NO/2CO sequence 0-1-2-3-4-5-6 16A shaft \varnothing 6x4.6mm shaft L 23mm connection screw 7-position ceramic		
accessories for	300025		
	Part No.	112172	Ref. No. —
	knob universal \varnothing 70mm black without adaptor/dial plate		
	Part No.	112213	Ref. No. —
	knob dial plate silver switch 7-position t.max.°C ED \varnothing 63mm ID \varnothing 45.5mm		
	Part No.	112311	Ref. No. —
	knob adapter shaft \varnothing 6x4.6mm L 0mm with spring		

lamps

indicator lights

indicator lights (complete)

\varnothing 9mm



1

Part No.	359137	Ref. No.	10080001
description	indicator light \varnothing 9mm 230V yellow connection male faston 6.3mm temp.-resist. 120°C with lens		

\varnothing 10mm

with plug-in socket



1

Part No.	359138	Ref. No.	10080002
description	indicator light \varnothing 10mm red 230V connection male faston 6.3mm Qty 1 pcs		



1

Part No.	359140	Ref. No.	10080004
description	indicator light \varnothing 10mm yellow 230V connection male faston 6.3mm Qty 1 pcs		

linear lamps

halogen lamps



1

Part No.	359620	Ref. No.	10080106
description	halogen lamp socket R7s L 117.6mm 230V 300W unjacketed IMPORT CE		

sockets for linear lamps

R7s



1

Part No.	359649	Ref. No.	10081001
description	lamp socket socket RX7S \varnothing 8mm L 45mm W 31mm H 35mm connection cable 350mm mounting distance 8/35mm cable material silicone Qty 1 pcs		





oven lamps

universal oven lamps

mounting diameter 65.5mm



1

Part No.	359712	Ref. No.	10080301
description	oven lamp mounting \varnothing 65.5mm 230V 40W socket E14 temp.-resist. 300°C connection male faston 6.3mm hard glas		
spare parts for	359712		
	Part No.	359022	Ref. No. —
	lamp socket socket E14 mounting \varnothing 65.5mm connection male faston 6.3mm		
	Part No.	359611	Ref. No. —
	light bulb t.max. 300°C socket E14 40W 230V \varnothing 45mm L 75mm lens L 50mm for oven lamp IMPORT		
	Part No.	359722	Ref. No. —
	gasket silicone ID \varnothing 57.5mm ED \varnothing 68mm thickness 2mm		
	Part No.	359724	Ref. No. —
	oven lamp glass thread \varnothing 62mm H 46mm \varnothing 74mm hard glas temp.-resist. 350°C		



motors

gear motors

for gyros grills



1

Part No.	500605	Ref. No.	10130100
description	gear motor CROUZET type 805274 16.7W 230V 50Hz 1rpm shaft \varnothing 7x8mm L 65mm W 65mm H 58mm		

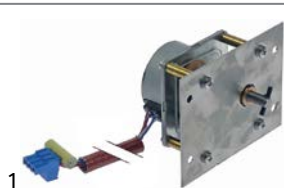

1

Part No.	500608	Ref. No.	10130104
description	gear motor CROUZET type 80527437 16.7W 230V 50Hz 1rpm shaft \varnothing 8mm L 64mm W 64mm H 59mm for gyro grill		

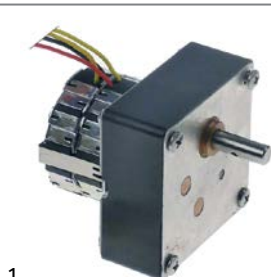

1

Part No.	499012	Ref. No.	10130104
description	gear motor MECHTEX 230V voltage AC 50Hz 1rpm shaft \varnothing 8mm L 68mm W 68mm shaft length 22mm		



1

Part No.	500606	Ref. No.	24011340
description	gear motor INOKSAN type 206 5W 230V 50Hz shaft \varnothing 16x19mm L 370mm W 180mm H 205mm for gyro grill		



1

Part No.	500607	Ref. No.	24023040
description	gear motor CROUZET type 89945210 16.7W 230V 50Hz 1rpm shaft \varnothing 12x12.5mm L 130mm W 110mm H 110mm for gyro grill		

electric accessories

plugs - couplings - power sockets

protective contact power sockets

producer-specific power sockets

miscellaneous



1

Part No.	550672	Ref. No.	10025101
description	power socket CEE7/4 type F built-in version 3-pole contacts P+N+E max. 16A max 230V with fine fuse countries D/I for gyro grill		

gas taps

ECA



1

Part No.	106013	Ref. No.	11030602	
description	gas tap ECA gas inlet pipe flange \varnothing 21mm bypass nozzle \varnothing 0.55mm gas outlet 1/4" (tube \varnothing 8mm) thermocouple connection M8x1 shaft \varnothing 8x6.5mm shaft L 20/13mm shaft flat upper front fixing M13x1			
spare parts for	106013			
	Part No.	101051	Ref. No.	—
	magnet unit L 27mm D1 \varnothing 12.5mm D2 \varnothing 8.5mm suitable for JUNKERS/EGA/MADEC/SABAF standard			
accessories for	106013			
	Part No.	101277	Ref. No.	—
	olive ID \varnothing 8mm Qty 1 pcs			
	Part No.	101351	Ref. No.	—
	mounting strap for gas tap			
	Part No.	520656	Ref. No.	—
	union nut thread 1/4" tube \varnothing 6/8mm			



ignition parts

thermocouples

plug-in thermocouples

plug-in thermocouples standard

with barrel socket $\varnothing 6(6.5)$ mm

thermocouples SIT

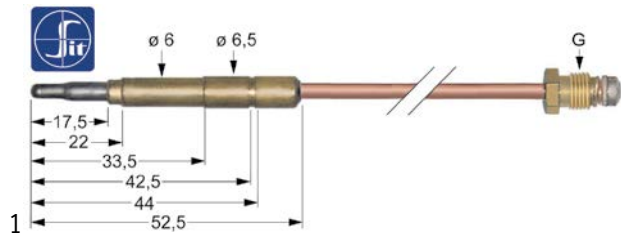

Part No.	107601	Ref. No.	11060004
description	thermocouple SIT M8x1 L 600mm plug connection $\varnothing 6.0(6.5)$ mm		

gas burners

ceramic burners



Part No.	105586	Ref. No.	11070001
description	ceramic burner L 235mm W 172mm firing range 178x125mm for gyro grill		

accessories

burner grids

Part No.	105587	Ref. No.	24000210
description	burner grid L 423mm W 173mm for gyro grill		

Part No.	105588	Ref. No.	24010210
description	burner grid L 490mm W 230mm for gyro grill		

Part No.	105589	Ref. No.	24010410
description	burner grid L 500mm W 230mm for gyro grill		

Part No.	105591	Ref. No.	24010371
description	burner grid L 500mm W 230mm for gyro grill		

Part No.	105592	Ref. No.	24010510
description	burner grid L 660mm W 165mm for gyro grill		

Part No.	105590	Ref. No.	24020210
description	burner grid L 670mm W 230mm for gyro grill		

Part No.	105593	Ref. No.	24020310
description	burner grid L 670mm W 230mm for gyro grill		

Part No.	105568	Ref. No.	24000720
description	burner grid L 493mm W 173mm		

Part No.	105581	Ref. No.	24010760
description	burner grid L 563mm W 215mm		

Part No.	105569	Ref. No.	24010720
description	burner grid L 731mm W 171mm		

Part No.	105582	Ref. No.	24020720
description	burner grid L 732mm W 215mm		



equipment-specific units

for griddles

sumps



1

Part No.	693428	Ref. No.	24010310
description	grease collecting tray		

for gyros grills

brakes



1

Part No.	691820	Ref. No.	24023520
description	locking lever for gyros grill motor mounting pos. upper thread M10		



1

Part No.	691821	Ref. No.	24003111
description	locking lever for sliding valve mounting pos. lower thread M10		



1

Part No.	691819	Ref. No.	24003051 24024390
description	slide for gyro grill mounting pos. lower thread M8		



1

Part No.	691818	Ref. No.	24024360 24024391
description	slide for gyro grill mounting pos. upper thread M8		

glass panels



1

Part No.	693194	Ref. No.	24019502
description	glass panel L 450mm W 128mm thickness 4mm rectangular		



1

Part No.	693195	Ref. No.	24029502
description	glass panel L 600mm W 130mm thickness 4mm rectangular		

scoops



1

Part No.	691825	Ref. No.	24000080
description	scoop for gyro grill L 130mm W 185/250mm		



skewers



1

Part No.	691822	Ref. No.	24014112
description	skewer for gyro grill size 12x12mm L 585mm		



1

Part No.	691823	Ref. No.	24013373
description	skewer for gyro grill size 12x12mm L 650mm		



1

Part No.	691824	Ref. No.	24023126
description	skewer for gyro grill size 12x12mm L 800mm		

skewer plates



1

Part No.	691817	Ref. No.	24000010
description	skewer plate ø 120mm intake 12x12mm		

skewer holders



1

Part No.	691833	Ref. No.	24023501
description	skewer holder for gyro grill L 505mm W 25mm H 25mm mounting pos. lower		



1

Part No.	691832	Ref. No.	24023510
description	skewer holder for gyro grill L 550mm W 20mm H 20mm mounting pos. upper		

cotter pins



1

Part No.	693457	Ref. No.	24003133
description	retainer clip L 73mm wire gauge ø 3mm zinc-coated steel Qty 1 pcs		

miscellaneous



1

Part No.	691834	Ref. No.	24013180
description	turnstile for gyro grill		

for hot dog machines

lids



1

Part No.	693192	Ref. No.	24209025
description	lid for hot dog machine		

glass cylinders



1

Part No.	693190	Ref. No.	24209022
description	glass cylinder ø 207mm with bottom H 240mm		



skewers



Part No.	693189	Ref. No.	24203001
-----------------	--------	-----------------	----------

description	bun spikes aluminium
--------------------	----------------------

for pizza ovens

glass panels

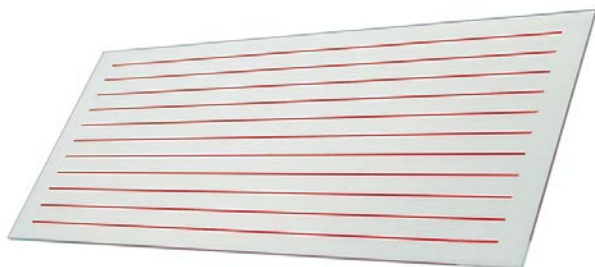

1

Part No.	693197	Ref. No.	22319033
-----------------	--------	-----------------	----------

description	glass panel L 565mm W 230mm thickness 5mm rectangular
--------------------	---

firebricks



1

Part No.	850062	Ref. No.	22209053
-----------------	--------	-----------------	----------

description	firebrick L 515mm W 515mm H 15mm mounting pos. pizza oven delivery freight forwarding company only
--------------------	--



1

Part No.	850063	Ref. No.	22319052
-----------------	--------	-----------------	----------

description	firebrick L 880mm W 290mm H 20mm mounting pos. pizza oven delivery freight forwarding company only
--------------------	--

doors



1

Part No.	693196	Ref. No.	22200080
-----------------	--------	-----------------	----------

description	door complete suitable for pizza oven
--------------------	---------------------------------------



1

Part No.	693198	Ref. No.	22300020
-----------------	--------	-----------------	----------

description	door complete suitable for pizza oven
--------------------	---------------------------------------

for rolling grills

pipes

pipes



1

Part No.	693185	Ref. No.	24303000
-----------------	--------	-----------------	----------

description	pipe with gear wheel for roller grill
--------------------	---------------------------------------

for toasters

drive shafts



1

Part No.	693179	Ref. No.	24403023
-----------------	--------	-----------------	----------

description	drive shaft for conveyor toaster \varnothing 12/14mm SS L 320mm
--------------------	---



1 

Part No.	693182	Ref. No.	24413023
description	drive shaft for conveyor toaster \varnothing 8/12mm stainless steel L 360mm		

miscellaneous

1 

Part No.	693184	Ref. No.	24413052
description	conveyor belt L 1000mm W 310mm wire gauge \varnothing 1.2mm		

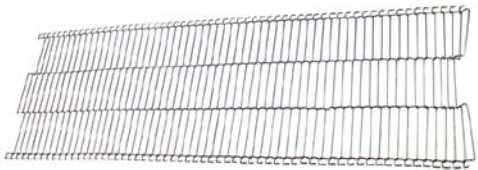
1 

Part No.	693181	Ref. No.	24403052
description	conveyor belt L 490mm W 310mm wire gauge \varnothing 2mm		

gear wheels

1 

Part No.	693180	Ref. No.	24403035
description	gear wheel teeth 10 shaft intake \varnothing 14mm \varnothing 63mm hub \varnothing 30mm stainless steel		

1 

Part No.	693187	Ref. No.	24303006
description	gear wheel teeth 17 shaft intake \varnothing 7mm \varnothing 35mm hub \varnothing 22mm stainless steel		

1 

Part No.	693183	Ref. No.	24413035
description	gear wheel teeth 20 shaft intake \varnothing 12mm \varnothing 48mm hub \varnothing 22mm		

knobs

producer-specific knobs

INOKSAN

1 

Part No.	111551	Ref. No.	24506020
description	knob energy regulator Min/Max \varnothing 55mm shaft \varnothing 6x4.6mm shaft flat universal black		

1 

Part No.	111775	Ref. No.	24016012 24016012+27006104
description	knob gas tap without ignition flame t.max.°C \varnothing 55mm shaft \varnothing 8x6.5mm shaft flat universal black		

1 

Part No.	111261	Ref. No.	24506023+27006103
description	knob graduated \varnothing 55mm shaft \varnothing 6x4.6mm shaft flat universal black		

1 

Part No.	111546	Ref. No.	24106100 24106109
description	knob switch 0-1-0-1 \varnothing 55mm shaft \varnothing 6x4.6mm shaft flat universal black		





			
1			
Part No.	111540	Ref. No.	24016101 INO2401 6107 + INO2700 6103
description	knob switch 4-position ø 55mm shaft ø 6x4.6mm shaft flat universal black		

			
1			
Part No.	111552	Ref. No.	24016100 24016103 24016103+27006104
description	knob switch 7-position t.max. °C ø 55mm shaft ø 8x6.5mm shaft flat universal black		

			
1			
Part No.	111541	Ref. No.	26106000
description	knob thermostat t.max. 110°C ø 55mm shaft ø 6x4.6mm shaft flat universal black temperature range 30-110°C rotation 270°		

			
1			
Part No.	111544	Ref. No.	22206000 22206003+27006103
description	knob thermostat t.max. 500°C ø 55mm shaft ø 6x4.6mm shaft flat lower black temperature range 50-500°C rotation 270°		

			
1			
Part No.	111547	Ref. No.	24106106 24106110
description	knob thermostat t.max. 90°C ø 55mm shaft ø 6x4.6mm shaft flat universal black temperature range 30-90°C rotation 270°		

			
1			
Part No.	111545	Ref. No.	24106102
description	knob dial plate switch 0-1-0-1 grey		

handles and hand wheels

mushroom cap handles

			
1			
Part No.	693193	Ref. No.	13120107
description	mushroom cap handle thread M4 handle ø 25mm L 21.5mm chrome-plated steel		

bracket handles

			
1			
Part No.	693427	Ref. No.	13120106
description	pull handle L 165mm H 55mm mounting distance 130mm thread M8		

locks

edgmount latches

handle latches

CAFF/FERMOD





			
1			
Part No.	690400	Ref. No.	13120200
description	handle latch L 135mm mounting distance 120mm non lockable refrigeration units G 680		
accessories for	690400		
	Part No.	690418	Ref. No. —
	door catch L 36mm W 19mm H 29mm mounting distance 12mm zinc-coated steel for refrigeration units		

Table continues overleaf

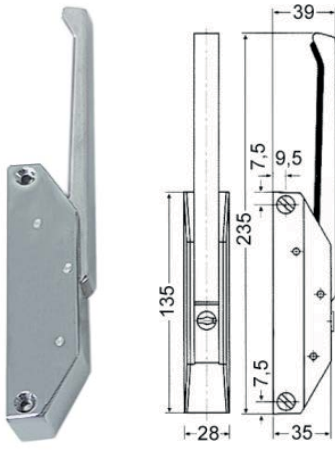

accessories for 690400			
	Part No.	690419	Ref. No. —
door catch L 52mm W 20mm H 30mm mounting distance 26-37mm zamak for refrigeration units			
	Part No.	700435	Ref. No. —
door catch L 58mm W 20mm H 35mm mounting distance 42mm zamak for refrigeration units			

baskets

wire baskets for hot dog machines

			
1	Part No.	693191	Ref. No. 24203021
description grid basket for hot dog grill ø 180mm H 210mm			

gaskets

gaskets for heated units

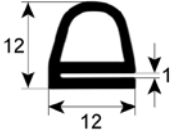
door seals			
			
1	Part No.	901296	Ref. No. 04060203
description door seal profile 2211 W 12mm L 4m suitable for INOKSAN for banquet trolley ABS200			

transmission technology and ball bearings

chains

roller chains 04B-1 single

1			
Part No.	693188	Ref. No.	24303020
description chain DIN/ISO 04 B-1 splitting 6mm links 53 internal width 2.8mm rollerø 4mm single without connecting bow			

kitchen accessories

spillage trays

1			
Part No.	698240	Ref. No.	15340020
description drain tray ø 450mm H 35mm			

fastening material

fasteners

retainer clips

1			
Part No.	693457	Ref. No.	24003133
description retainer clip L 73mm wire gauge ø 3mm zinc-coated steel Qty 1 pcs			

retaining rings

DIN 471

1			
Part No.	693186	Ref. No.	13130025
description retaining ring shaft ø 25mm thickness 1.2mm steel DIN 471			

mechanical components,
equipment accessories
1

GASTROPARTS.COM

