



GASTROPARTS

Infrico

- [EN]** Equipment
- [DE]** Geräte
- [ES]** Aparatos
- [FR]** Équipement
- [IT]** Attrezzature
- [PL]** Urządzenia
- [RU]** Оборудование

✉ gastroparts@gastroparts.com

☎ +48 56 657 00 66

📘 fb.com/gastroparts.global

GASTROPARTS.COM





heating elements

heating cartridges

1 

Part No.	420552	Ref. No.	406X40
description	heating cartridge 200W 230V ø 12mm L 180mm thread 3/8" cable length 3mm		

1 

Part No.	420553	Ref. No.	406X42
description	heating cartridge 450W 230V ø 12mm L 285mm thread 3/8" cable length 60mm		

foil heating elements

1 

Part No.	418856	Ref. No.	406x32
description	foil heating element L 210mm W 116mm 200W 220V t.max. 130°C with temperature limiter silicone cable length 500mm thickness 1mm connection male faston 6.3mm		

1 

Part No.	418855	Ref. No.	406X30 406x31
description	foil heating element L 210mm W 58mm 100W 220V t.max. 130°C with temperature limiter silicone cable length 500mm thickness 1mm connection male faston 6.3mm suitable for INFRICO		

thermostats

refrigeration thermostats

DANFOSS

control thermostats

1 

Part No.	390677	Ref. No.	308X10
description	thermostat type 077B0028 capillary pipe 1200mm temperature range -4,5 up to +10,5°C probe ømm probe Lmm		

miscellaneous producers

1 

Part No.	390678	Ref. No.	308X09
description	thermostat temperature range -15 up to +15°C probe ø7x83mm capillary pipe 100mm		

switches and momentary switches

rocker/momentary rocker switches

30x22mm

1 

Part No.	301003	Ref. No.	405X04
description	rocker switch mounting measurements 30x22mm green 2NO 250V 16A illuminated 0-I connection male faston 6.3mm ambient temperature max. 125/55°C protection IP65		
accessories for	301003		
	Part No.	301036	Ref. No. 405X13
description	protective cover internal size 30x22mm for rocker switch mounting measurementsmm		

1 

Part No.	301036	Ref. No.	405X13
description	protective cover internal size 30x22mm for rocker switch mounting measurementsmm		

			
1			
Part No.	347159	Ref. No.	405X03
description	rocker switch mounting measurements 30x22mm red 2NO 250V 16A heating connection male faston 6.3mm ambient temperature max. 85/125°C protection IP40		

			
1			
Part No.	347019	Ref. No.	405X02
description	rocker switch mounting measurements 30x22mm orange 2NO 250V 16A illuminated lamp connection male faston 6.3mm ambient temperature max. 100/55°C protection IP40		

push/momentary push switches

19x13mm

			
1			

Part No.	346538 ¹	Ref. No.	405X05
description	push switch mounting measurements 19x13mm green 2NO 250V 16A illuminated connection male faston 4.8mm ambient temperature max. 105/55°C protection IP40		

accessories for	346538			
	Part No.	346541	Ref. No.	—
	protective cover for rocker switch external size 23.4x17.4mm internal size 19x13mm H 9.5mm mounting measurementsmm			

¹illuminated

			
1			

Part No.	346542 ¹	Ref. No.	405X06
description	push switch mounting measurements 19x13mm yellow 2NO 250V 16A illuminated connection male faston 4.8mm ambient temperature max. 85°C protection IP40		

accessories for	346542			
	Part No.	346541	Ref. No.	—
	protective cover for rocker switch external size 23.4x17.4mm internal size 19x13mm H 9.5mm mounting measurementsmm			

¹illuminated

30x22mm

			
1			

Part No.	301036	Ref. No.	405X13
description	protective cover internal size 30x22mm for rocker switch mounting measurementsmm		

microswitches

lever actuated

			
1			

Part No.	347160	Ref. No.	405X07 405X10
description	microswitch with lever 250V 16A 1CO connection male faston 6.3mm L 59.5mm ambient temperature max. 85°C mounting distance mm type AM51612D53 actuating force: 35g lever length 54mm		

transformers

encapsulated transformers

PMA

			
1			

Part No.	379054	Ref. No.	308X12
description	transformer primary 230VAC secondary 12VAC 3VA secondary 0.25A H 40mm L 45mm W 50mm connection screw 50/60Hz type 153/M		

electronic controllers

CAREL

refrigeration controllers

built-in version

			
1			

Part No.	403512	Ref. No.	308x05 -> 61d
description	electronic controller CAREL PBIFCOHND61 mounting measurements 138x29mm built-in depth 70.5mm 230V voltage AC NTC relay outputs 4 NO-10A(10) CO-12A(2) NO-8A(4) CO-8A(4) NTC NTC DI DI yes 2xNTC probe inclusive protection IP54 -50 up to +99°C display 3½ digits		

spare parts for	403512			
	Part No.	379161	Ref. No.	308X04
	temperature probe NTC 10kOhm cable thermoplastic probe -40 up to +110°C cable -40 up to +110°C probe ø6x14mm cable length 3m without screw connection 2-wire			



 <p>138 x 29mm</p>			
1			
Part No.	402160	Ref. No.	308X11 308x11 -> 51d 308X41 PMIF6T0015
description	electronic controller CAREL PBIF0EVD51 mounting measurements 138x29mm built-in depth 70.5mm 230V voltage AC NTC relay outputs 3 CO-12A(2) CO-8A(4) NO-8A(4) NTC NTC DI I yes 2xNTC probe inclusive protection IP65 -50 up to +99°C display 3½ digits		
spare parts for	402160		
	Part No.	Ref. No.	308X04
	temperature probe NTC 10kOhm cable thermoplastic probe -40 up to +110°C cable -40 up to +110°C probe ø6x14mm cable length 3m without screw connection 2-wire		

			
1			
Part No.	379698	Ref. No.	308X51
description	electronic controller DIXELL XR60CX-5R0C1 mounting measurements 71x30mm 230V voltage AC NTC relay outputs 3 relays 1x NTC probe inclusive -55 up to +150°C display 3½ digits RoomTempIN yes DEF Relay 8(3)A fan relay 5A evaporator probe yes compressor relay 20(8)A		

DIXELL

refrigeration controllers

built-in version

			
1			
Part No.	402157	Ref. No.	308x01
description	electronic controller DIXELL XR20C-0R0C3 mounting measurements 71x29mm built-in depth 76mm 12V voltage AC/DC NTC relay outputs 1 CO-16A(5) NTC/PTC protection IP54 0-60°C display 3½ digits		

			
1			
Part No.	381470	Ref. No.	308X23
description	electronic controller DIXELL XW20L-5L0D8-N mounting measurements 150x30mm built-in depth 65.5mm 230V voltage AC NTC relay outputs 2 16(6)A 16(6)A		

			
1			
Part No.	381469	Ref. No.	308X57
description	electronic controller DIXELL XR30CX-5R0C1 mounting measurements 71x29mm built-in depth 50mm 230V voltage AC NTC relay outputs 2 NO-20A(8) CO-8A(3)		

			
1			
Part No.	402159	Ref. No.	308X27
description	electronic controller DIXELL XW40L mounting measurements 150x31mm built-in depth 50mm 230V voltage AC NTC relay outputs 3 protection -50 up to +150°C display 3½ digits 3 RoomTempIN NTC/PTC DEF Probe NTC/PTC TempIN3 DEF Relay CO-8A(3) fan relay DigiIN 1 compressor relay NO-20A(8) light relay NO-8A(3) alarm relay auxiliary relay		
accessories for	402159		
	Part No.	Ref. No.	—
	temperature probe NTC 10kOhm cable PVC probe -20 up to +80°C cable -10 up to 100°C probe ø7x24.5mm cable length 1.5m without screw connection 2-wire		
	Part No.	Ref. No.	—
	temperature probe NTC 10kOhm cable PVC probe -20 up to +80°C cable -10 up to 100°C probe ø6x25mm cable length 3m 2-wire		
	Part No.	Ref. No.	308X16
	temperature probe NTC 10kOhm cable thermoplastic probe -40 up to +110°C cable -40 up to +110°C probe ø6x14mm cable length 1.5m without screw connection 2-wire		
	Part No.	Ref. No.	308X04
	temperature probe NTC 10kOhm cable thermoplastic probe -40 up to +110°C cable -40 up to +110°C probe ø6x14mm cable length 3m without screw connection 2-wire		









 <p>71 x 29mm</p>			
1			
Part No.	402158	Ref. No.	308X02
description	electronic controller DIXELL XR40C-0R0C3 mounting measurements 71x29mm 12V voltage AC/DC NTC relay outputs 2 CO-16A(5) CO-16A(5) NTC/PTC NTC/PTC protection IP54 0-60°C display 3½ digits		

Table continues overleaf



accessories for	402159			
	Part No.	379343	Ref. No.	—
	temperature probe NTC 10kOhm cable silicone probe -40 up to +110°C cable -50 up to +180°C probe ø6x40mm cable length 3m 2-wire			
	Part No.	379458	Ref. No.	—
	temperature probe NTC 10kOhm cable silicone probe -40 up to +110°C cable -50 up to +180°C probe ø6x40mm cable length 1.5m without screw connection 2-wire			



Part No.	379699	Ref. No.	308x05	
description	electronic controller DIXELL XW60L-5L0D0-X mounting measurements 150x30mm built-in depth 65.5mm 230V voltage AC NTC/PTC relay outputs 4 NO-20A(8) CO-8A(3) NO-8A(3) NO-16A(5) NTC/PTC NTC/PTC DI -50 up to +150°C display 3½ digits			
accessories for	379699			
	Part No.	378194	Ref. No.	—
	temperature probe NTC 10kOhm cable PVC probe -20 up to +80°C cable -10 up to 100°C probe ø7x24.5mm cable length 1.5m without screw connection 2-wire			
	Part No.	379057	Ref. No.	—
	temperature probe NTC 10kOhm cable PVC probe -20 up to +80°C cable -10 up to 100°C probe ø6x25mm cable length 3m 2-wire			
	Part No.	379160	Ref. No.	308X16
	temperature probe NTC 10kOhm cable thermoplastic probe -40 up to +110°C cable -40 up to +110°C probe ø6x14mm cable length 1.5m without screw connection 2-wire			
	Part No.	379161	Ref. No.	308X04
	temperature probe NTC 10kOhm cable thermoplastic probe -40 up to +110°C cable -40 up to +110°C probe ø6x14mm cable length 3m without screw connection 2-wire			
	Part No.	379343	Ref. No.	—
	temperature probe NTC 10kOhm cable silicone probe -40 up to +110°C cable -50 up to +180°C probe ø6x40mm cable length 3m 2-wire			
	Part No.	379458	Ref. No.	—
	temperature probe NTC 10kOhm cable silicone probe -40 up to +110°C cable -50 up to +180°C probe ø6x40mm cable length 1.5m without screw connection 2-wire			

SHANGFANG

accessories





Part No.	379054	Ref. No.	308X12
description	transformer primary 230VAC secondary 12VAC 3VA secondary 0.25A H 40mm L 45mm W 50mm connection screw 50/60Hz type 153/M		

probes

universal probes

temperature probes

1			
Part No.	379160	Ref. No.	308X16
description	temperature probe NTC 10kOhm cable thermoplastic probe -40 up to +110°C cable -40 up to +110°C probe ø6x14mm cable length 1.5m without screw connection 2-wire		

1			
Part No.	379161	Ref. No.	308X04
description	temperature probe NTC 10kOhm cable thermoplastic probe -40 up to +110°C cable -40 up to +110°C probe ø6x14mm cable length 3m without screw connection 2-wire		

solenoïd valves

solenoïd valves (refrigeration)

DANFOSS

valves

1			
Part No.	370542	Ref. No.	308X03
description	solenoid valve NC type EVO101 p max 45.2bar -40° up to 105°C 230V		

pressure switches

for refrigeration

SAGI NO MIYA

1			
Part No.	541643	Ref. No.	305X06
description	pressure control p max 45bar type ACB-2UB115W switch-off pressure 28bar switch-on pressure 22bar		



R404a/R507

LBP monophase

Lower evaporation temperature below -20°C



1

Part No.	605081	Ref. No.	301A01
description	compressor coolant R404a/R507 type NJ2212GK 220-240V 50Hz LBP fully hermetic 21.5kg 1 1/2HP power input 1150W cylinder capacity 34cm ³ CSR H 277mm 880W 1269W 1738W 2289W 2921W 2921WWWWW test method ASHRAE		

SECOP DANFOSS

R134A

HMBP monophase

High/Medium evaporation temperature above -20/-15 °C



1

Part No.	605089	Ref. No.	301D04
description	compressor coolant R134a type NL8.4MF 220-240V 50Hz HMBP fully hermetic 10.5kg 1/4HP cylinder capacity 8.35cm ³ RSIR/CSIR H 197mmW 235W 305W 390W 491W 610W 749W 912W test method ASHRAE		

spare parts for	605089			
	Part No.	381528	Ref. No.	—
	start relay DANFOSS 117U6016 HST			

evaporation and condensing trays

condensing trays heated

universal

heating cartridges

1



Part No.	420552	Ref. No.	406X40
description	heating cartridge 200W 230V ø 12mm L 180mm thread 3/8" cable length 3mm		

1



Part No.	420553	Ref. No.	406X42
description	heating cartridge 450W 230V ø 12mm L 285mm thread 3/8" cable length 60mm		

fans

axial fans

ebm-papst

1



Part No.	601458 ¹	Ref. No.	304X26
description	axial fan L 119mm W 119mm H 38mm 230VAC 50Hz 19W bearing ball bearing manuf. no. 4656N metal connection male faston 2.8mm ebm-papst fan wheel ø 110mm temp.-resist. 85°C		

accessories for	601458			
	Part No.	692497	Ref. No.	—
	guard ø 105mm mounting distance 150mm for axial fan ebm-papstmm			

¹with ball bearings

1



Part No.	601635 ¹	Ref. No.	304X17
description	axial fan L 127mm W 127mm H 38mm 230VAC 50/60Hz 18W bearing ball bearing manuf. no. 5958 connection male faston 2.8mm ebmpapst		



¹with ball bearings



			
1			
Part No.	601649 ¹	Ref. No.	304X03
description	axial fan L 127mm W 127mm H 38mm 230VAC 50/60Hz 18W bearing ball bearing manuf. no. 5958W cable length 280mm connection cable PAPST		

¹with ball bearings

import

			
1			
Part No.	601080 ¹	Ref. No.	304R01
description	axial fan L 119mm W 119mm H 38mm 230VAC 50/60Hz 23/20W bearing ball bearing connection male faston 2.8mm metal ADDA fan wheel ø 110mm temp.-resist. 70°C		
accessories for	601080		
	Part No.	550898	Ref. No. —
	connecting cable cable length 2000mm connection F 2.8 connection distance 7.9mm for axial flow fan		
	Part No.	692519	Ref. No. —
	guard L 120mm W 120mm plastic		

¹with ball bearings

refrigeration fans

refrigeration motors universal

ELCO

N series - multi fit

			
1			
Part No.	601430	Ref. No.	304X02
description	fan motor ELCO 5W 230V 50/60Hz bearing slide bearing L1 48mm L2 52mm L3 79.5mm W 83mm connection cable 500mm 1300/1550rpm 5 mounting options VNT5-13/027		
spare parts for	601430		
	Part No.	560140	Ref. No. —
	hexagonal nut thread M4 H 4.8mm SS WS 7 Qty 20 pcs DIN/ISO DIN 985 self-locking		
	Part No.	560332	Ref. No. —
	plain washer ID ø 4.3mm ED ø 9mm thickness 0.8mm SS Qty 1 pcs		
	Part No.	560340	Ref. No. —
	hexagonal nut thread M4 H 3.2mm WS 7 SS DIN/ISO DIN 934 / ISO 4032/8673 Qty 1 pcs		
	Part No.	601413	Ref. No. —
	fixing plate suitable for fanwheel ED ø 32mm shaft ø 7 mounting distance 26mm		

accessories

fan wheels

aluminium

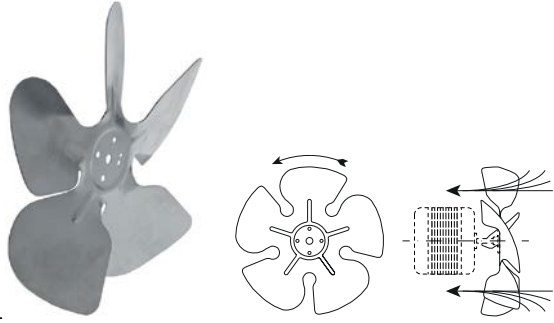
			
1			
Part No.	601070	Ref. No.	304X06
description	fan wheel sucking ø 200mm fan wheel mounting 25.4mm blade angle 28° W 38mm aluminium		



1

Part No.	601072	Ref. No.	304X07
description	fan wheel sucking ø 250mm fan wheel mounting 25.4mm blade angle 25° W 50mm aluminium		

feet

1

Part No.	601137	Ref. No.	304X09
description	foot for fan motor H 70mm W 50mm mounting distance 85mm		

1

Part No.	601076	Ref. No.	304X10
description	foot for fan motor H 84mm mounting distance 81mm		

cooling motors (various)

refrigeration motors with foot

1

Part No.	601653	Ref. No.	304X01
description	fan motor 10W 230V 50Hz L1 43mm L3 83mm W 83mm feet depth 84mm cable length 450mm		

cross flow fans

ebm-papst

1

Part No.	601650	Ref. No.	304X25
description	cross flow fan ebm-papst QLZ06/0018-2518 roller ø 60mm roller length 180mm laminated core thickness 18mm motor position left 230V/50Hz 30W refrigeration bearing rubber connection male faston 6.3mm airflow 130m³/h 0 up to +60°C		

1

Part No.	601651	Ref. No.	304X28
description	cross flow fan ebm-papst QLZ06/0024-3030 roller ø 60mm roller length 240mm laminated core thickness 30mm motor position left 230V/50Hz 38W refrigeration bearing rubber connection male faston 6.3mm airflow 170m³/h 0 up to +60°C		

1

Part No.	601652	Ref. No.	304X39
description	cross flow fan QL4/2500-2118 roller ø 40mm roller length 250mm laminated core thickness 18mm motor position right 230V/50Hz 15W refrigeration bearing silicone connection F 6.3 airflow 100m³/h 0 up to +60°C 230V 50Hz		



equipment-specific units

for fridges

spare parts and accessories



1

Part No.	970957	Ref. No.	603X242
description	clip for grate for fridge L 63mm plastic		

drawers

drawers



1

Part No.	694956	Ref. No.	PUEEB15
description	drawer front for fridge L 430mm H 275mm D 23mm SS		

handles and hand wheels

bracket handles



1

Part No.	701417	Ref. No.	506X34
description	pull handle L 280mm mounting distance 227mm hole \varnothing 5.5mm for fridge		

recessed handles



1

Part No.	694957	Ref. No.	506X91
description	recessed handle L 130mm W 50mm H 35mm mounting distance 106/120mm plastic for display refrigerator		

hinges

spring assisted hinges

universal

CAFF/FERMOD

group 2



1

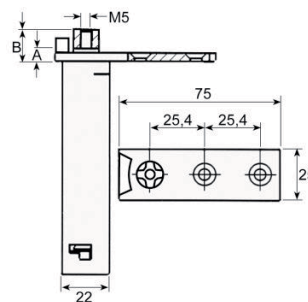

Part No.	700853	Ref. No.	506X03
description	spring assisted hinge series TRS/1 mounting pos. right/left L 75mm W 26mm H 113mm A 4mm B 13mm mounting measurements 22x22mm intake torx refrigeration units mounting distance 25mm		

producer-specific

INFRICO



1

Part No.	700882	Ref. No.	506X89
description	hinge camp L 26mm W 100mm H 123mm mounting pos. left		







 <p>1</p>			
Part No.	700878	Ref. No.	506X116
description	spring assisted hinge L 38mm W 18mm H 78mm refrigeration units mounting measurements 17x17mm mounting pos. left		

 <p>1</p>			
Part No.	700877	Ref. No.	506X115
description	spring assisted hinge L 38mm W 18mm H 78mm refrigeration units mounting pos. bottom right mounting measurements 17x17mm		

door bearing

 <p>1</p>			
Part No.	692575	Ref. No.	506X57
description	bracket L 60mm W 33mm H 12mm mounting pos. left bolt ø 6mm for lid suitable for saladette		

 <p>1</p>			
Part No.	692574	Ref. No.	1100482 506X58
description	bracket L 60mm W 33mm H 12mm mounting pos. right bolt ø 6mm for lid suitable for saladette		

 <p>1</p>			
Part No.	700883	Ref. No.	701X70
description	door bolt L 10mm ø 7mm		
accessories for	700883		
	Part No.	560064	Ref. No. —
flat-headed bolt thread M4 thread L 20mm SS DIN 7985/ISO 7045 Qty 20 pcs intake Phillips head ø 8mm head thickness 2mm			
	Part No.	560115	Ref. No. —
plain washer ID ø 4.3mm ED ø 12mm thickness 1.2mm SS Qty 20 pcs DIN 9021 for thread M4			

 <p>1</p>			
Part No.	700879	Ref. No.	506X118
description	hinge camp mounting pos. left L 100mm W 48mm H 17mm zinc die cast, chrome-plated shaft diameter 6x6mm		

 <p>1</p>			
Part No.	700880	Ref. No.	506X117
description	hinge camp mounting pos. right L 100mm W 48mm H 17mm zinc die cast, chrome-plated shaft diameter 6x6mm		

 <p>1</p>			
Part No.	700854	Ref. No.	506x198 506x55
description	hinge camp type TRB/L1 36mm mounting pos. bottom right L 100mm W 48mm H 17mm zinc die cast, chrome-plated hole distance 6.5x51x28mm shaft diameter torx 12x12mmmm		

 <p>1</p>			
Part No.	700855	Ref. No.	506x197 506x54
description	hinge camp type TRB/R1 36mm mounting pos. bottom left L 100mm W 48mm H 17mm zinc die cast, chrome-plated hole distance 6.5x51x-28mm shaft diameter torx 12x12mmmm		

accessories

bushes

 <p>1</p>			
Part No.	694958	Ref. No.	603X58
description	bush blind for display refrigerator ID ø 6mm ED ø 9mm L 15mm mounting pos. lower		

 <p>1</p>			
Part No.	694959	Ref. No.	603X68
description	bush for display refrigerator ID ø 6mm ED ø 9mm L 15mm		



pullouts

drawer slides

universal

compeX

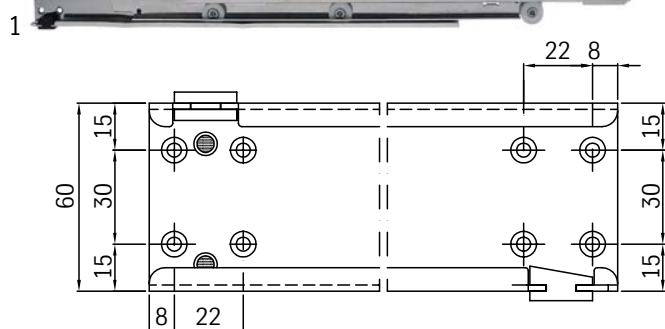

Part No.	696342 ¹	Ref. No.	503X31
-----------------	---------------------	-----------------	--------

description drawer slide L 450mm pull-out length 510mm total length 960mm Qty 1 pair capacity 50kg W 17mm H 60mm mounting pos. right/left SS telescopic

spare parts for 696342

	Part No.	690750	Ref. No.	—
		stop for telescopic rail L 20mm plastic H 12mm D 9mm		

	Part No.	696333	Ref. No.	—
		stop for telescopic rail L 20mm plastic H 15mm D 8mm		

¹multiple slide (60mm more than nominal length)

compeX

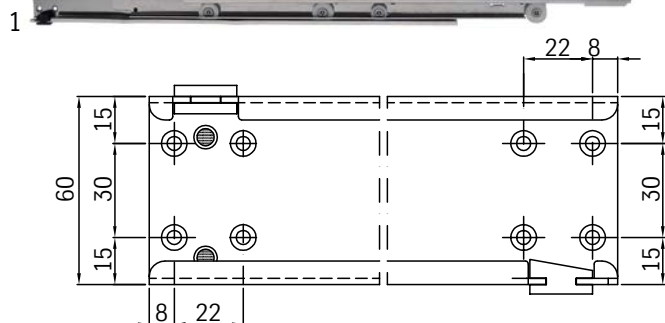

Part No.	690753 ¹	Ref. No.	503X32
-----------------	---------------------	-----------------	--------

description telescopic slide pair L 550mm pull-out length 610mm total length 1160mm Qty 1 pair capacity 50kg H 60mm SS telescopic

spare parts for 690753

	Part No.	690750	Ref. No.	—
		stop for telescopic rail L 20mm plastic H 12mm D 9mm		

	Part No.	696333	Ref. No.	—
		stop for telescopic rail L 20mm plastic H 15mm D 8mm		

¹multiple slide (60mm more than nominal length)

accessories



Part No.	970957	Ref. No.	603X242
description	clip for grate for fridge L 63mm plastic		

rollers

rollers



Part No.	692771	Ref. No.	506E02
description	roller rollerø 19.5mm B1 6mm overall width 6.5mm plastic/metal tread plastic with ball bearing thread M4		

shelves and shelf rails

grates

universal

without upstand



Part No.	970960	Ref. No.	502x12
description	grate W 325mm D 530mm GN 1/1 plastic-coated steel for fridge wire gauge frame 8mm lengthwise wires gauge 4mm crossing wires 12 grey		



Part No.	970954	Ref. No.	502X07
description	grate W 430mm D 325mm H 10.5mm plastic-coated steel for fridge wire gauge frame 8mm lengthwise wires gauge 4mm crossing wires 12 grey		

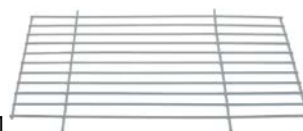

Part No.	970956	Ref. No.	504X32
description	grate W 475mm D 430mm H 7mm plastic-coated steel for display refrigerator wire gauge frame 4.5mm lengthwise wires gauge 4mm crossing wires 11 white		



1

Part No.	970955	Ref. No.	502X04
description	grate W 530mm D 460mm H 11mm plastic-coated steel for fridge wire gauge frame 8mm lengthwise wires gauge 3.5mm crossing wires 20 grey		



1

Part No.	970953	Ref. No.	502X14
description	grate W 650mm D 530mm GN 2/1 H 11mm plastic-coated steel for fridge wire gauge frame 8mm lengthwise wires gauge 4mm crossing wires 20 grey		

shelf rails and supports

producer-specific



1

Part No.	701614	Ref. No.	503X17
description	guide U-shape L 520mm W 25mm H 13/15mm mounting pos. right Qty 1		



1

Part No.	701599	Ref. No.	503X15
description	guide U-shape L 550mm W 25mm H 13/15mm mounting pos. left Qty 1 BMGN		



1

Part No.	701613	Ref. No.	503X20
description	guide U-shape L 550mm W 25mm H 13/15mm mounting pos. right Qty 1 BMGN		



1

Part No.	701597	Ref. No.	503X02
description	guide U-shape L 630mm W 25mm H 13/15mm mounting pos. left Qty 1 AGN		



1

Part No.	701598	Ref. No.	503X03
description	guide U-shape L 630mm W 25mm H 13/15mm mounting pos. right Qty 1 AGN		

gaskets

refrigeration gaskets

plug-in gaskets

profile 9798

We offer custom-made gaskets for this profile

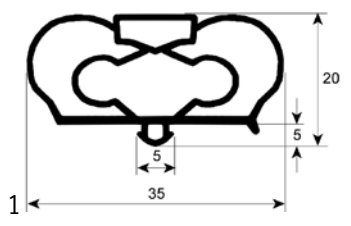

1

Part No.	900971	Ref. No.	602A47
description	refrigeration gasket profile 9798 W 426mm L 1542mm plug size		

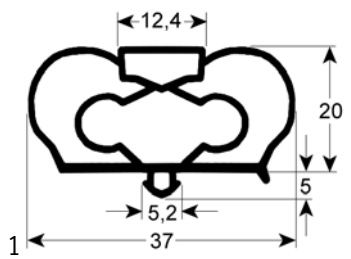

1

Part No.	900961	Ref. No.	602B20
description	refrigeration gasket profile 9798 W 426mm L 156mm plug size		



Part No.	901137	Ref. No.	602A49
description	refrigeration gasket profile 9798 W 426mm L 212mm plug size		

Part No.	900968	Ref. No.	602B23
description	refrigeration gasket profile 9798 W 426mm L 551mm plug size		

Part No.	900962	Ref. No.	602B18
description	refrigeration gasket profile 9798 W 426mm L 260mm plug size		

Part No.	900969	Ref. No.	602B02
description	refrigeration gasket profile 9798 W 426mm L 576mm plug size		

Part No.	900963	Ref. No.	602A48
description	refrigeration gasket profile 9798 W 426mm L 343mm plug size		

Part No.	900970	Ref. No.	602A46
description	refrigeration gasket profile 9798 W 426mm L 738mm plug size		

Part No.	900966	Ref. No.	602B21
description	refrigeration gasket profile 9798 W 426mm L 365mm plug size		

Part No.	901138	Ref. No.	602F01
description	refrigeration gasket profile 9798 W 426mm L 776mm plug size		

Part No.	900967	Ref. No.	602X30
description	refrigeration gasket profile 9798 W 426mm L 456mm plug size		

Part No.	900972	Ref. No.	602M18
description	refrigeration gasket profile 9798 W 501mm L 174mm plug size		



Part No.	900973	Ref. No.	602M19
description	refrigeration gasket profile 9798 W 501mm L 260mm plug size		

Part No.	900976	Ref. No.	602A01
description	refrigeration gasket profile 9798 W 631mm L 665mm plug size		

Part No.	900974	Ref. No.	602M01
description	refrigeration gasket profile 9798 W 501mm L 576mm plug size		

Part No.	900975	Ref. No.	602A06
description	refrigeration gasket profile 9798 W 631mm L 738mm plug size		

Part No.	900977	Ref. No.	602A86
description	refrigeration gasket profile 9798 W 631mm L 1351mm plug size		

Part No.	900980	Ref. No.	602A03
description	refrigeration gasket profile 9798 W 740mm L 1396mm plug size		

Part No.	900978	Ref. No.	602A02
description	refrigeration gasket profile 9798 W 631mm L 1396mm plug size		

Part No.	902038	Ref. No.	N/A
description	refrigeration gasket profile 9798 Wmm L 2500mm		

Part No.	900979	Ref. No.	602A05
description	refrigeration gasket profile 9798 W 631mm L 1542mm plug size		

screw-in gaskets

profile 9954

We offer custom-made gaskets for this profile

Part No.	902313	Ref. No.	N/A
description	refrigeration gasket profile 9954 Wmm L 2500mm		



refrigeration cycle components

valves

expansion valves

DANFOSS

valves

type TUA/TUB/TUC



1

Part No.	750278	Ref. No.	305X05
description	expansion valve DANFOSS type TUB coolant R404a/R507 angled 90° thermostatically controlled inlet 1/4" ODF outlet 1/2" ODF		

filter driers

DANFOSS



1

Part No.	750277	Ref. No.	305X03
description	dryer type DML 032S		

miscellaneous



1

Part No.	750226	Ref. No.	305X01
description	dryer size 20g ø 24mm L 117mm connection 6.2/6.3mm		



1

Part No.	750276	Ref. No.	305X03 (old version)
description	dryer size 30g ø 24mm L 147mm connection 6,5/6,5mm		

evaporation and condensing trays

evaporation trays



1

Part No.	694962	Ref. No.	501X22
description	evaporation tray SS L 365mm W 95mm H 45mm for refrigerated shelf		

springs

torsion springs



1

Part No.	514436	Ref. No.	506X04
description	torsion spring ø 17mm wire gauge ø 2.5mm L1 28mm L2 9mm L3 20mm Qty 1 pcs		

coffee accessories

coffee grounds drawers



1

Part No.	530886	Ref. No.	203X12
description	coffee drawer bar rubber ø 41mm L 308mm		

measuring equipment

thermometers

built-in thermometers



1

Part No.	541080	Ref. No.	308X06
description	thermometer mounting measurements 58x25.5mm -40 up to +40°C capillary pipe 2500mm probe ø 6mm probe L 30mm		

GASTROPARTS.COM

