



GASTROPARTS

Indesit

[EN] Equipment

[DE] Geräte

[ES] Aparatos

[FR] Équipement

[IT] Attrezzature

[PL] Urządzenia

[RU] Оборудование

✉ gastroparts@gastroparts.com

☎ +48 56 657 00 66

📘 fb.com/gastroparts.global

GASTROPARTS.COM





heating elements

heating elements for ovens

1

Part No.	415775	Ref. No.	10013150430 C00055155 C00144237
description	heating element 1750W 230V heating circuits 1 L 326mm W 405mm L1 34mm L2 292mm W1 170mm W2 60mm flange length 100mm flange width 22mm hole distance 86mm tube ø 6.3mm connection male faston 6.3mm mounting pos. lower rectangular flange dry heating element oven mounting thread M4		

1

Part No.	415774	Ref. No.	10013150420 16002032700 C00049942 C00141175
description	heating element 3050W 230V heating circuits 2 L 325mm W 474mm L1 40mm L2 285mm W1 237mm W2 60mm flange length 100mm flange width 22mm hole distance 85mm bridge length 620mm hole ø M4mm tube ø 6.3mm connection male faston 6.3mm mounting pos. upper rectangular flange dry heating element oven		

thermostats

control and safety thermostats

EGO

control thermostats

55.10/19_ series



1

Part No.	375314	Ref. No.	C00089745
description	thermostat t.max. 320°C temperature range 50-320°C 1-pole 1NO 16A probe ø 3mm probe L 120mm capillary pipe 1200mm capillary pipe isolatedmm gland nut shaft ø 6x4.6mm shaft L 23mm shaft position upper rotation 270° with 2 probes		



1

Part No.	375723	Ref. No.	10013023740 16001142401 C00049941 C00066814
description	thermostat t.max. 320°C temperature range 50-320°C 1-pole 1NO 16A probe ø 3mm probe L 219mm capillary pipe 900mm capillary pipe isolated 700mm gland nut shaft ø 6x4.6mm shaft L 23mm shaft position upper rotation 270°		

switches and momentary switches

push/momentary push switches

ø25mm



1

Part No.	346002	Ref. No.	10013101580 C00052234
description	momentary push switch mounting ø 25mm red 2NO 250V 16A connection male faston 6.3mm ambient temperature max. 85°C protection IP40		



			
1			
Part No.	346432	Ref. No.	10013101570 C00052405
description	push switch mounting \varnothing 25mm red 1NO 250V 16A connection male faston 6.3mm ambient temperature max. 85°C protection IP40		

cam switches

5 operating positions

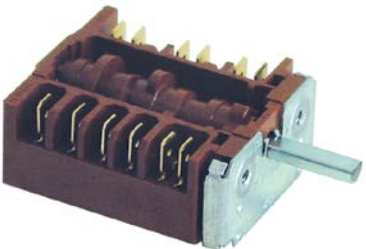
			
1			
Part No.	300114	Ref. No.	10013000860 C00055060
description	cam switch 5 operating positions 5NO sequence 0-1-2-3-4 16A shaft \varnothing 6x4.6mm shaft L 23mm connection male faston 6.3mm		

10 operating positions

			
1			
Part No.	300135	Ref. No.	10013113960 C00052299
description	cam switch 10 operating positions 10NO sequence 0-1-2-3-4-5-6-7-8-9 16A shaft \varnothing 6x4.6mm shaft L 23mm connection male faston 6.3mm plastic		

operation switches

			
1			
Part No.	300119	Ref. No.	10013000860 C00055060
description	operation switch 6 operating positions 5NO 16A sequence 0-1-2-3-4-5 shaft \varnothing 6x4.6mm shaft L 23mm connection male faston 6.3mm plastic ambient temperature max. 318°C		

lamps

indicator lights

indicator lights (complete)

 \varnothing 13mm



with plug-in socket

			
1			
Part No.	359141	Ref. No.	10013000611 1600151800 16001518000 C00053645 C00089743
description	indicator light \varnothing 13mm red 230V connection male faston 6.3mm temp.-resist. 120°C Qty 1 pcs		

oven lamps

universal oven lamps

mounting diameter 35.5mm

				
1				
Part No.	359718	Ref. No.	10013070240 10013177630 C00052173	
description	oven lamp mounting \varnothing 35.5mm 230V 15W socket E14 temp.-resist. 300°C connection male faston 6.3mm hard glas			
spare parts for	359718			
	Part No.	359701	Ref. No.	—
	lamp socket socket E14 220-230V mounting \varnothing 35.5mm connection male faston 6.3mm 15W			
	Part No.	359740	Ref. No.	—
	light bulb t.max. 300°C socket E14 15W 230V \varnothing 22mm L 48mm lens L 20mm for oven lamp IMPORT			

solenoid valves

drain valves

			
1			
Part No.	370789	Ref. No.	C00501094
description	drain valve 220-240V 50/60Hz NO inlet 50mm outlet 50/35mm MDB-0-2-SO		



gas taps

SABAF

1 

Part No.	107382	Ref. No.	C00091517
description	gas tap SABAF type 10 gas inlet pipe flange ø16mm bypass nozzle ø 0.24mm gas outlet M13x1 IT (tube ø 8mm) front fixing thermocouple connection plug-in connection shaft ø 6x4.6mm shaft L 35/16mm shaft flat upper		

1 

Part No.	107379	Ref. No.	C00059239
description	gas tap SABAF type 10 gas inlet pipe flange ø16mm bypass nozzle ø 0.27mm gas outlet M13x1 IT (tube ø 8mm) front fixing thermocouple connection plug-in connection shaft ø 6x4.6mm shaft L 35/15mm shaft flat upper		

1 

Part No.	107381	Ref. No.	C00096735
description	gas tap SABAF type 10 gas inlet pipe flange ø16mm bypass nozzle ø 0.38mm gas outlet M13x1 IT (tube ø 8mm) front fixing thermocouple connection plug-in connection shaft ø 6x4.6mm shaft L 35/15mm shaft flat upper		

1 

Part No.	107380	Ref. No.	C00091519
description	gas tap SABAF type 10 gas inlet pipe flange ø16mm bypass nozzle ø 0.52mm gas outlet M13x1 IT (tube ø 8mm) front fixing thermocouple connection plug-in connection shaft ø 6x4.6mm shaft L 35/15mm shaft flat upper		

ignition parts

electrodes

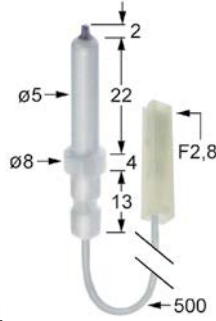
1 

Part No.	107383	Ref. No.	C00075911
description	ignition electrode D1 ø 5mm cable length 500mm connection male faston 2.8mm D2 ø 8mm L1 2mm BL1 22mm BL2 4mm BL3 13mm		

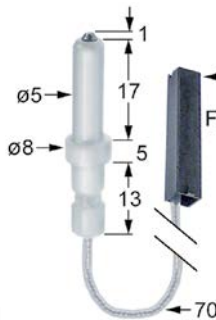
1 

Part No.	107384	Ref. No.	C00052951 C00118496
description	ignition electrode D1 ø 5mm cable length 700mm connection male faston 2.8mm D2 ø 8mm L1 1mm BL1 17mm BL2 5mm BL3 13mm		
accessories for	107384		
	Part No.	102498	Ref. No. C00052934
	spring clip for ignition electrode		

1 

Part No.	102498	Ref. No.	C00052934
description	spring clip for ignition electrode		

ignition units

1 

Part No.	101037	Ref. No.	10001493104 10013234490 16001493104 C00031720
description	ignition unit outputs 6		

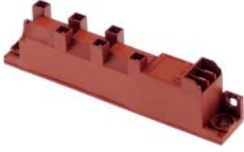
1

Part No.	102389	Ref. No.	C00193106
description	ignition unit outputs 6 230VAC dimensions 135x23x34mm mounting distance 123mm inlet F6.3x0.8 outlet F2.8x0.8 0.6VA 50/60Hz		

thermocouples

threaded thermocouples

threaded thermocouples with cable link



1

Part No.	102271	Ref. No.	C00118495
description	thermocouple with two-conductors L 600mm M6x0.75 F 7.7mm M4		
accessories for	102271		
	Part No.	102680	Ref. No. —
	nut thread M6x0.75 H 2.6mm WS 8 brass Qty 1 pcs type SEF 2		

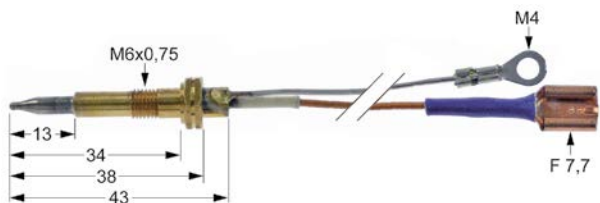

1

Part No.	107385	Ref. No.	C00096748
description	thermocouple with two-conductors L 600mm M6x0.75 F 7.7mm M4		

gas burners

hob burners



universal hob burners

SABAF

2 series - standard



1

Part No.	107373	Ref. No.	10013218848 C00059422 C00064919
description	burner cap 1.8kW ø 75mm matt finish		
accessories for	107373		
	Part No.	104271	Ref. No. C00052929
	burner head 1.8kW for burner cap ø 75mm		
	Part No.	107372	Ref. No. 17000100800 C00052926
	burner lower part 1.8kW for igniter ø 6mm for thermocouple ø 6mm without nozzle for burner cap ø 75mm		





1

Part No.	107697	Ref. No.	C00064918
description	burner cap 1kW ø 50mm matt finish		





1

Part No.	107374	Ref. No.	10013218858 480121104537 C00064920
description	burner cap 3kW ø 100mm H 3.5mm matt finish		
accessories for	107374		
	Part No.	105058	Ref. No. 10013218810 C00052928
	burner head 3kW for igniter ø 6mm for burner cap ø 100mm		
	Part No.	105059	Ref. No. 17000100700 C00052925
	burner lower part 3kW for igniter ø 6mm for thermocouple ø 6mm without nozzle for burner cap ø 100mm		





1

Part No.	104271	Ref. No.	C00052929
description	burner head 1.8kW for burner cap ø 75mm		
accessories for	104271		
	Part No.	107372	Ref. No. 17000100800 C00052926
	burner lower part 1.8kW for igniter ø 6mm for thermocouple ø 6mm without nozzle for burner cap ø 75mm		
	Part No.	107373	Ref. No. 10013218848 C00059422 C00064919
	burner cap 1.8kW ø 75mm matt finish		



1

Part No.	107376	Ref. No.	10013218790 C00052930
description	burner head 1kW for igniter ø 6mm for burner cap ø 50mm		
accessories for	107376		
	Part No.	107375	Ref. No. 17000000900 C00052927
	burner lower part 1kW for igniter ø 6mm for thermocouple ø 6mm without nozzle for burner cap ø 50mm		



1









Part No.	105058	Ref. No.	10013218810 C00052928
description	burner head 3kW for igniter ø 6mm for burner cap ø 100mm		
accessories for	105058		
	Part No.	105054	Ref. No. —
	burner cap 3kW ø 100mm H 3.5mm bright finish		

Table continues overleaf







accessories for 105058			
	Part No.	105059	Ref. No. 17000100700 C00052925
burner lower part 3kW for igniter ø 6mm for thermocouple ø 6mm without nozzle for burner cap ø 100mm			
	Part No.	107374	Ref. No. 10013218858 480121104537 C00064920
burner cap 3kW ø 100mm H 3.5mm matt finish			

			
1			
Part No.	107372	Ref. No.	17000100800 C00052926
description	burner lower part 1.8kW for igniter ø 6mm for thermocouple ø 6mm without nozzle for burner cap ø 75mm		
accessories for 107372			
	Part No.	104271	Ref. No. C00052929
burner head 1.8kW for burner cap ø 75mm			
	Part No.	107373	Ref. No. 10013218848 C00059422 C00064919
burner cap 1.8kW ø 75mm matt finish			

			
1			
Part No.	107375	Ref. No.	17000000900 C00052927
description	burner lower part 1kW for igniter ø 6mm for thermocouple ø 6mm without nozzle for burner cap ø 50mm		
accessories for 107375			
	Part No.	107376	Ref. No. 10013218790 C00052930
burner head 1kW for igniter ø 6mm for burner cap ø 50mm			

			
1			
Part No.	105059	Ref. No.	17000100700 C00052925
description	burner lower part 3kW for igniter ø 6mm for thermocouple ø 6mm without nozzle for burner cap ø 100mm		
accessories for 105059			
	Part No.	105054	Ref. No. —
burner cap 3kW ø 100mm H 3.5mm bright finish			
	Part No.	105058	Ref. No. 10013218810 C00052928
burner head 3kW for igniter ø 6mm for burner cap ø 100mm			
	Part No.	107374	Ref. No. 10013218858 480121104537 C00064920
burner cap 3kW ø 100mm H 3.5mm matt finish			



2 series - flat skirt version			
			
1			
Part No.	107372	Ref. No.	17000100800 C00052926
description	burner lower part 1.8kW for igniter ø 6mm for thermocouple ø 6mm without nozzle for burner cap ø 75mm		
accessories for 107372			
	Part No.	104271	Ref. No. C00052929
burner head 1.8kW for burner cap ø 75mm			
	Part No.	107373	Ref. No. 10013218848 C00059422 C00064919
burner cap 1.8kW ø 75mm matt finish			



			
1			
Part No.	107375	Ref. No.	17000000900 C00052927
description	burner lower part 1kW for igniter ø 6mm for thermocouple ø 6mm without nozzle for burner cap ø 50mm		
accessories for 107375			
	Part No.	107376	Ref. No. 10013218790 C00052930
burner head 1kW for igniter ø 6mm for burner cap ø 50mm			





			
1			
Part No.	105059	Ref. No.	17000100700 C00052925
description	burner lower part 3kW for igniter ø 6mm for thermocouple ø 6mm without nozzle for burner cap ø 100mm		
accessories for 105059			
	Part No.	105054	Ref. No. —
burner cap 3kW ø 100mm H 3.5mm bright finish			
	Part No.	105058	Ref. No. 10013218810 C00052928
burner head 3kW for igniter ø 6mm for burner cap ø 100mm			
	Part No.	107374	Ref. No. 10013218858 480121104537 C00064920
burner cap 3kW ø 100mm H 3.5mm matt finish			





triple ring burner series - standard version



			
1			
Part No.	107377	Ref. No.	10013218868 C00064921
description	burner cap 3.6kW ø 131mm H 4mm mounting pos. outer matt finish		
accessories for	107377		
	Part No.	107378	Ref. No. 10013218878 C00064922
burner cap 3.6kW ø 61mm H 6.5mm mounting pos. inner matt finish			



			
1			
Part No.	107378	Ref. No.	10013218878 C00064922
description	burner cap 3.6kW ø 61mm H 6.5mm mounting pos. inner matt finish		
accessories for	107378		
	Part No.	107377	Ref. No. 10013218868 C00064921
burner cap 3.6kW ø 131mm H 4mm mounting pos. outer matt finish			



			
1			
Part No.	105065	Ref. No.	C00053173
description	burner head 3.6kW for burner cap ø 61/131mm		
accessories for	105065		
	Part No.	105063	Ref. No. —
burner cap 3.6kW ø 131mm H 4mm mounting pos. outer			
	Part No.	105064	Ref. No. —
burner cap 3.6kW ø 61mm H 6.5mm mounting pos. inner bright finish			
	Part No.	105717	Ref. No. —
burner lower part 3.6kW for igniter ø 6mm for thermocouple ø 6mm with nozzle ø1.35mm ID ø 64mm for burner cap ø 61/131mm			

			
1			
Part No.	105066	Ref. No.	C00053254
description	burner lower part 3.6kW for igniter ø 6mm for thermocouple ø 6mm without nozzle ID ø 64mm for burner cap ø 61/131mm		
accessories for	105066		
	Part No.	101277	Ref. No. —
olive ID ø 8mm Qty 1 pcs			
	Part No.	101477	Ref. No. —
union screw thread M13x1 tube ø 8mm Qty 1 pcs			

triple ring burner series - flat skirt version

			
1			
Part No.	107377	Ref. No.	10013218868 C00064921
description	burner cap 3.6kW ø 131mm H 4mm mounting pos. outer matt finish		
accessories for	107377		
	Part No.	107378	Ref. No. 10013218878 C00064922
burner cap 3.6kW ø 61mm H 6.5mm mounting pos. inner matt finish			

			
1			
Part No.	107378	Ref. No.	10013218878 C00064922
description	burner cap 3.6kW ø 61mm H 6.5mm mounting pos. inner matt finish		
accessories for	107378		
	Part No.	107377	Ref. No. 10013218868 C00064921
burner cap 3.6kW ø 131mm H 4mm mounting pos. outer matt finish			

			
1			
Part No.	105066	Ref. No.	C00053254
description	burner lower part 3.6kW for igniter ø 6mm for thermocouple ø 6mm without nozzle ID ø 64mm for burner cap ø 61/131mm		
accessories for	105066		
	Part No.	101277	Ref. No. —
olive ID ø 8mm Qty 1 pcs			
	Part No.	101477	Ref. No. —
union screw thread M13x1 tube ø 8mm Qty 1 pcs			

producer-specific hob burners

STAR (INDESIT)

600 series

			
1			
Part No.	105903	Ref. No.	10013105629 C00047837
description	burner cap ø 69mm		





			
1			
Part No.	105904	Ref. No.	10013105619 C00049696
description	burner cap ø 89mm		



			
1			
Part No.	105900	Ref. No.	10013117952 C00056071
description	burner head for burner cap ø 69mm		

			
1			
Part No.	105898	Ref. No.	10013117943 C00061136
description	burner head for burner cap ø 89mm		



			
1			
Part No.	105899	Ref. No.	10013002540 C00056386
description	burner holder with nozzle holder		



			
1			
Part No.	105901	Ref. No.	10013111240 C00047835
description	burner ring for burner cap ø 69mm		



			
1			
Part No.	105902	Ref. No.	10013111230 C00059001
description	burner ring for burner cap ø 89mm		

			
1			
Part No.	107373	Ref. No.	10013218848 C00059422 C00064919
description	burner cap 1.8kW ø 75mm matt finish		
accessories for	107373		
			
Part No.	104271	Ref. No.	C00052929
description	burner head 1.8kW for burner cap ø 75mm		
			
Part No.	107372	Ref. No.	17000100800 C00052926
description	burner lower part 1.8kW for igniter ø 6mm for thermocouple ø 6mm without nozzle for burner cap ø 75mm		



			
1			
Part No.	107697	Ref. No.	C00064918
description	burner cap 1kW ø 50mm matt finish		



			
1			
Part No.	107377	Ref. No.	10013218868 C00064921
description	burner cap 3.6kW ø 131mm H 4mm mounting pos. outer matt finish		
accessories for	107377		
			
Part No.	107378	Ref. No.	10013218878 C00064922
description	burner cap 3.6kW ø 61mm H 6.5mm mounting pos. inner matt finish		





			
1			
Part No.	107378	Ref. No.	10013218878 C00064922
description	burner cap 3.6kW ø 61mm H 6.5mm mounting pos. inner matt finish		
accessories for	107378		
			
Part No.	107377	Ref. No.	10013218868 C00064921
description	burner cap 3.6kW ø 131mm H 4mm mounting pos. outer matt finish		





			
1			
Part No.	107374	Ref. No.	10013218858 480121104537 C00064920
description	burner cap 3kW ø 100mm H 3.5mm matt finish		
accessories for	107374		
			
Part No.	105058	Ref. No.	10013218810 C00052928
description	burner head 3kW for igniter ø 6mm for burner cap ø 100mm		
			
Part No.	105059	Ref. No.	17000100700 C00052925
description	burner lower part 3kW for igniter ø 6mm for thermocouple ø 6mm without nozzle for burner cap ø 100mm		







			
1			
Part No.	104271	Ref. No.	C00052929
description	burner head 1.8kW for burner cap ø 75mm		
accessories for	104271		
	Part No.	107372	Ref. No. 17000100800 C00052926
	burner lower part 1.8kW for igniter ø 6mm for thermocouple ø 6mm without nozzle for burner cap ø 75mm		
	Part No.	107373	Ref. No. 10013218848 C00059422 C00064919
	burner cap 1.8kW ø 75mm matt finish		



			
1			
Part No.	107376	Ref. No.	10013218790 C00052930
description	burner head 1kW for igniter ø 6mm for burner cap ø 50mm		
accessories for	107376		
	Part No.	107375	Ref. No. 17000000900 C00052927
	burner lower part 1kW for igniter ø 6mm for thermocouple ø 6mm without nozzle for burner cap ø 50mm		

			
1			
Part No.	105065	Ref. No.	C00053173
description	burner head 3.6kW for burner cap ø 61/131mm		
accessories for	105065		
	Part No.	105063	Ref. No. —
	burner cap 3.6kW ø 131mm H 4mm mounting pos. outer		
	Part No.	105064	Ref. No. —
	burner cap 3.6kW ø 61mm H 6.5mm mounting pos. inner bright finish		
	Part No.	105717	Ref. No. —
	burner lower part 3.6kW for igniter ø 6mm for thermocouple ø 6mm with nozzle ø 1.35mm ID ø 64mm for burner cap ø 61/131mm		

			
1			
Part No.	105058	Ref. No.	10013218810 C00052928
description	burner head 3kW for igniter ø 6mm for burner cap ø 100mm		
accessories for	105058		
	Part No.	105054	Ref. No. —
	burner cap 3kW ø 100mm H 3.5mm bright finish		
	Part No.	105059	Ref. No. 17000100700 C00052925
	burner lower part 3kW for igniter ø 6mm for thermocouple ø 6mm without nozzle for burner cap ø 100mm		
	Part No.	107374	Ref. No. 10013218858 480121104537 C00064920
	burner cap 3kW ø 100mm H 3.5mm matt finish		

			
1			
Part No.	107372	Ref. No.	17000100800 C00052926
description	burner lower part 1.8kW for igniter ø 6mm for thermocouple ø 6mm without nozzle for burner cap ø 75mm		
accessories for	107372		
	Part No.	104271	Ref. No. C00052929
	burner head 1.8kW for burner cap ø 75mm		
	Part No.	107373	Ref. No. 10013218848 C00059422 C00064919
	burner cap 1.8kW ø 75mm matt finish		

			
1			
Part No.	107375	Ref. No.	17000000900 C00052927
description	burner lower part 1kW for igniter ø 6mm for thermocouple ø 6mm without nozzle for burner cap ø 50mm		
accessories for	107375		
	Part No.	107376	Ref. No. 10013218790 C00052930
	burner head 1kW for igniter ø 6mm for burner cap ø 50mm		

			
1			
Part No.	105066	Ref. No.	C00053254
description	burner lower part 3.6kW for igniter ø 6mm for thermocouple ø 6mm without nozzle ID ø 64mm for burner cap ø 61/131mm		
accessories for	105066		
	Part No.	101277	Ref. No. —
	olive ID ø 8mm Qty 1 pcs		
	Part No.	101477	Ref. No. —
	union screw thread M13x1 tube ø 8mm Qty 1 pcs		







			
1			
Part No.	105059	Ref. No.	17000100700 C00052925
description	burner lower part 3kW for igniter ø 6mm for thermocouple ø 6mm without nozzle for burner cap ø 100mm		
accessories for	105059		
	Part No.	105054	Ref. No. —
	burner cap 3kW ø 100mm H 3.5mm bright finish		
	Part No.	105058	Ref. No. 10013218810 C00052928
	burner head 3kW for igniter ø 6mm for burner cap ø 100mm		



Table continues overleaf



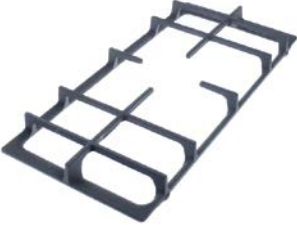

accessories for		105059	
	Part No.	107374	Ref. No.
			10013218858 480121104537 C00064920
burner cap 3kW ø 100mm H 3.5mm matt finish			

pan supports

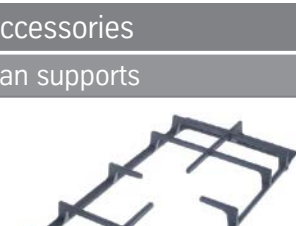

			
1			
Part No.	210037	Ref. No.	C00085447
description	pan support W 225mm L 485mm H 45mm mounting measurements 455x225mm mounting pos. centre suitable for INDESIT		
accessories for	210037		
	Part No.	210036	Ref. No.
			C00085446
pan support W 275mm L 484mm H 45mm mounting measurements 455x260mm mounting pos. lateral suitable for INDESIT			



			
1			
Part No.	210036	Ref. No.	C00085446
description	pan support W 275mm L 484mm H 45mm mounting measurements 455x260mm mounting pos. lateral suitable for INDESIT		
accessories for	210037		
	Part No.	210037	Ref. No.
			C00085447
pan support W 225mm L 485mm H 45mm mounting measurements 455x225mm mounting pos. centre suitable for INDESIT			

			
1			
Part No.	210037	Ref. No.	C00085447
description	pan support W 225mm L 485mm H 45mm mounting measurements 455x225mm mounting pos. centre suitable for INDESIT		
accessories for	210036		
	Part No.	210036	Ref. No.
			C00085446
pan support W 275mm L 484mm H 45mm mounting measurements 455x260mm mounting pos. lateral suitable for INDESIT			

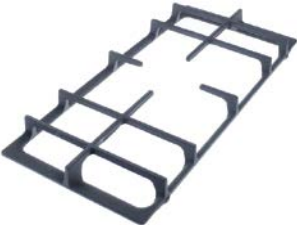
accessories

pan supports

			
1			
Part No.	210037	Ref. No.	C00085447
description	pan support W 225mm L 485mm H 45mm mounting measurements 455x225mm mounting pos. centre suitable for INDESIT		
accessories for	210037		
	Part No.	210036	Ref. No.
			C00085446
pan support W 275mm L 484mm H 45mm mounting measurements 455x260mm mounting pos. lateral suitable for INDESIT			

			
1			
Part No.	210036	Ref. No.	C00085446
description	pan support W 275mm L 484mm H 45mm mounting measurements 455x260mm mounting pos. lateral suitable for INDESIT		
accessories for	210036		
	Part No.	210037	Ref. No.
			C00085447
pan support W 225mm L 485mm H 45mm mounting measurements 455x225mm mounting pos. centre suitable for INDESIT			

Part No.	210036	Ref. No.	C00085446
description	pan support W 275mm L 484mm H 45mm mounting measurements 455x260mm mounting pos. lateral suitable for INDESIT		
accessories for	210036		
	Part No.	210037	Ref. No.
			C00085447
pan support W 225mm L 485mm H 45mm mounting measurements 455x225mm mounting pos. centre suitable for INDESIT			

gas nozzles

main nozzles

gas nozzles M6x0.75

			
1			
Part No.	103220	Ref. No.	C00145342
description	gas injector thread M6x0.75 WS 7 bore ø 1.24mm		

gas nozzles sets

			
1			
Part No.	102536	Ref. No.	10013239820 C00059236 C00089138
description	gas injector set LPG CUC.4+TC INDESIT code 1x 50, 2x 64, 2x 86, 1x 91		

hinges

oven hinges

			
1			
Part No.	701122	Ref. No.	C00271825
description	opposite support mounting distance 96mm L 248mm W 16mm		



1

			
1			
Part No.	700498	Ref. No.	10013160480 C00062398
description	opposite support oven hinge		

			
1			
Part No.	701121	Ref. No.	C00118487
description	oven hinge L 215mm mounting pos. left/right Qty 1 pcs		

			
1			
Part No.	701574	Ref. No.	085563
description	oven hinge mounting distance 112mm groove distance 9mm spring thickness 3.7mm spring length 75mm L 215mm W 22mm		

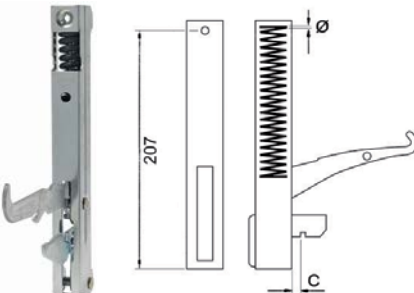
			
1			
Part No.	690037	Ref. No.	10013160490 C00062399
description	oven hinge mounting distance 205mm mounting distance 2mm lug mountingmm lever length 119mm groove distance 13mm spring thickness 4.3mm mounting ear position spring length 103mm L 214mm		

gaskets

gaskets for heated units

door seals



1

Part No.	900511	Ref. No.	10013150180 1440016280 1440016280 C00052152
description	door seal profile 2910 L 1230mm Qty 1		

door seals with fixing hook



1

Part No.	901494	Ref. No.	14400141800 14400141803 C00091946
description	oven gasket W 550mm open with mounting clip H 350mm		

O-rings

silicone

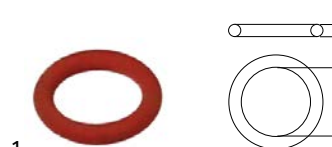

1

Part No.	532508	Ref. No.	10013151140 C00056376
description	O-ring silicone thickness 1.78mm ID \varnothing 6.75mm Qty 1 pcs		

GASTROPARTS.COM

