



GASTROPARTS

Imperial USA

- [EN]** Equipment
- [DE]** Geräte
- [ES]** Aparatos
- [FR]** Équipement
- [IT]** Attrezzature
- [PL]** Urządzenia
- [RU]** Оборудование

✉ gastroparts@gastroparts.com

☎ +48 56 657 00 66

📘 fb.com/gastroparts.global

GASTROPARTS.COM





thermostats

control and safety thermostats

INVENSYS / ROBERTSHAW

control thermostats



Part No.	390636	Ref. No.	0319 1175
description	thermostat t.max. 204°C temperature range 93-204°C 1-pole 1NO 0.67A probe ø 9.5mm probe L 123mm capillary pipe 915mm capillary pipe isolatedmm gland nut 1/4" NPT shaft ø 6x4.6mm shaft L 21mm shaft position lower rotation 315° probe material nickel-plated probe thread 1/4" US		
For models:	Fryer-Filter-System-Series, IF-25-Series-Fryers, IF-75-Series-Fryers, IFBL-Basketlift-System-Series-Fryers, IF-Counter-Fryer, IF-Series-Fryers		

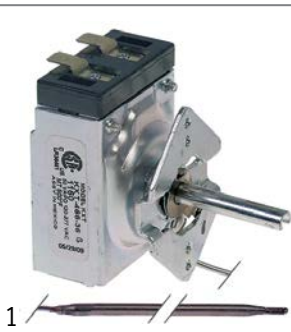

Part No.	390637	Ref. No.	1160
description	thermostat t.max. 260°C temperature range 93-260°C 1-pole 1NOA probe ø 4.5mm probe L 310mm capillary pipe 900mm capillary pipe isolatedmm gland nut shaft ø 6.5x4.7mm shaft L 32.5mm shaft position lower rotation 270° probe material SS		
For models:	ICV-and-ICVD-Series, IDR-Series, IR-Series-medium-duty-Range, ISAEGriddle		

safety thermostats



Part No.	390638	Ref. No.	33497
description	safety thermostat switch-off temp. 218°C temperature range°C 1-pole 1COA probe ø 8mm probe L 77mm capillary pipe 940mm capillary pipe isolatedmm gland nut 1/4" NPT shaft ømm probe SS		



Part No.	390639	Ref. No.	0328 1177
description	safety thermostat switch-off temp. 232°C 1-pole 1COA probe ø 7.9mm probe L 77mm capillary pipe 914mm capillary pipe isolatedmm gland nut 3/8" NPT shaft ømm probe SS 450°F		
For models:	Fryer-Filter-System-Series, IF-25-Series-Fryers, IF-75-Series-Fryers, IFBL-Basketlift-System-Series-Fryers, IF-Counter-Fryer, IF-Series-Fryers		



Part No.	390965	Ref. No.	36942
description	safety thermostat switch-off temp. 232°C 1-poleA probe ø 7.93mm probe L 77mm capillary pipe 760mm capillary pipe isolatedmm gland nut shaft ømm probe SS		

solenoïd valves

solenoïd valves (gas)



Part No.	106366	Ref. No.	1134 513-1
description	solenoid valve gas 2-ways 110V inlet 3/8" outlet 3/8" L 50mm		
For models:	ICV-and-ICVD-Series, IDR-Series, IR-Series-medium-duty-Range, ISAEGriddle, ISCE-Griddle		



gas taps

TEDDINGTON

1 gas components



1

Part No.	106370	Ref. No.	0252-1 1651-R
description	gas tap TEDDINGTON gas inlet flange (tube ø 1/4") left gas outlet 3/8"x27 UNF pilot connection 1/4" CCT thermocouple connection ASA 11/32 shaft ø 8.7x6.2mm shaft L 17/9mm shaft flat right ignition gas no		



1

Part No.	106717	Ref. No.	1660-L 38101 TESA2394/15L
description	gas tap TEDDINGTON type TESA2394/15L without ignition flame gas inlet flange (tube ø 1/4") left bypass nozzle ømm gas outlet 3/8"x27 UNF pilot connection thermocouple connection ASA 11/32 shaft ø 8.7x6.2mm shaft L 17/9mm shaft flat left		



1

Part No.	106377	Ref. No.	0276 1660-R 38102 TESA2394/15R
description	gas tap TEDDINGTON type TESA2394/15R gas inlet flange (tube ø 1/4") right bypass nozzle ømm gas outlet 3/8"x27 UNF pilot connection thermocouple connection ASA 11/32 shaft ø 8.7x6.2mm shaft L 17/9mm shaft flat right		



1

Part No.	106369	Ref. No.	1651-L 38099 TESA2394/8L
description	gas tap TEDDINGTON type TESA2394/8L gas inlet flange (tube ø 1/4") left bypass nozzle ømm gas outlet 3/8"x27 UNF pilot connection 1/4" CCT thermocouple connection ASA 11/32 shaft ø 8.7x6.2mm shaft L 17/9mm shaft flat left		



1

Part No.	106941	Ref. No.	1651-R 38100 TESA2394/8R
description	gas tap TEDDINGTON type TESA2394/8R gas inlet flange (tube ø 1/4") right bypass nozzle ømm gas outlet 3/8"x27 UNF pilot connection 1/4" CCT thermocouple connection ASA 11/32 shaft ø 8.7x6.2mm shaft L 17/9mm shaft flat right ignition gas 1/4" pipe US		

miscellaneous





1

Part No.	107845	Ref. No.	1610 1651-L
description	gas tap GARLAND gas inlet 1/8" bypass nozzle ømm gas outlet 1/8" pilot connection thermocouple connection shaft L 31/12mm		
For models:	EBA-Series-Char-Rock-Broilers, GD-Series-Char-Rock-Broilers, IAB-Series-Steakhouse-Broiler, ICB-Chicken-Broiler, ICMA-Series-Cheesemelter, ICRA-Series-chinese-range, IHPA-Series-Hot-Plate, IHR-Serieswith-standard-oven, IMGA-Series-Manually-controlled-Griddles, IPRA-and-IPR-Series-Pork-Roaster, IR2000-Series, IRB-Series-Radi ant-Char-Broilers, IR-Serie-Medium-Duty-Ranges, ISB-Series-Salamander-Broiler, ISPA-Series-stock-Pot, MSQ-Mesquite-Wood-Broiler		



gas thermostats

ROBERTSHAW



Part No.	106371	Ref. No.	1150 2019
description	gas thermostat type BJWA25PB t.max. 287°C 93-287°C 200-550°F gas inlet flange (tube ø 5/16") bypass nozzle ø 0mm gas outlet 1/4" NPT thermocouple connection pilot connection capillary pipe 48" - 1220mm probe ø 3/16" - 4.7mm probe L 11 1/4" - 285mm gland nut shaft ø 17mm shaft L 13mm shaft flat upper		
For models:	IR2000-Series, IR-Serie-Medium-Duty-Ranges		
accessories for	106371		
	Part No.	106659	Ref. No. 1104
	gas connection suitable for thermostat		
	Part No.	112547	Ref. No. 1151 2131
	knob gas thermostat t.max. 500°F 200-500°F ø 49mm shaft ømm shaft flat ROBERTSHAW black		
	Part No.	112735	Ref. No. 1101
	knob gas thermostat t.max. 400°F 150-400°F ø 49mm shaft ø 17mm black		



Part No.	106657	Ref. No.	1100
description	gas thermostat type BJWA25PBD0324 65-204°C 150-400°F gas inlet flange (tube ø 5/16") bypass nozzle ø 0mm gas outlet 2x 1/4" NPT thermocouple connection pilot connection capillary pipe 24" - 610mm probe ø 3/16" - 4.7mm probe L 7 3/4" - 195mm shaft ø 17mm shaft L 13mm shaft flat upper		
For models:	IHR-Series-with-standard-oven, IR2000-Series, IR-Serie-Medium-Duty-Ranges, ITG24, ITG36, ITG-Series-Thermostatically-controlled		
accessories for	106657		
	Part No.	106659	Ref. No. 1104
	gas connection suitable for thermostat		
	Part No.	112548	Ref. No. 1106 2011
	knob gas thermostat t.max. 400°F 150-400°F ø 49mm shaft ømm shaft flat ROBERTSHAW		

TEDDINGTON



Part No.	106372	Ref. No.	1179 36014
description	gas thermostat type COMSA006 t.max. 260°C gas inlet flange (tube ø 7.5mm) bypass nozzle ø 1.3mm gas outlet 1/4" NPTmm thermocouple connection ASA 11/32 pilot connection 1/8" capillary pipe 1100mm probe ø 4.8mm probe L 198mm shaft ø 8.8x6.3mm shaft L 28/19mm shaft flat lower		

gas valves and ignition boxes

gas control valves

HONEYWELL



Part No.	106361 ¹	Ref. No.	0365-2 1173-HW 1173-WR
description	gas valve type VS820A natural gas 0.75VHz gas inlet 3/4" NPT gas outlet 3/4" NPT thermocouple connection pilot connection 1/4" CCT pressure range 7.5-12.5mbar 3-5"W.C. operator type VS824A pressure controller type V5306A		
spare parts for	106361		
	Part No.	101408	Ref. No. —
	operator suitable for HONEYWELL supply Operator millivolt		

¹incl. reducer fittings 2x 1/2" NPT and 1x 3/8" NPT







ROBERTSHAW

millivolt controlled valves







1

Part No.	580031	Ref. No.	0365-2 1173 1173-HW 1173-WR
description	gas valve supply Operator millivolt gas inlet 3/4" NPT gas outlet 3/4" NPT thermocouple connection pilot connection 1/4" CCT type 7000BMVR pressure controller natural gas 3.5" W.C. suitable for ROBERTSHAW		
For models:	Fryer-Filter-System-Series, IF-25-Series-Fryers, IF-75-Series-Fryers, IF-BL-Basketlift-System-Series-Fryers, IF-Series-Fryers		
spare parts for	580031		
	Part No.	101422	Ref. No. —
	operator natural gas supply Operator millivolt		
	Part No.	106109	Ref. No. 28282
	locking screw thread 7/16"-24 UNS for pipe ø 1/4" L 16mm brass Qty 1 pcs WS 7/16" (11.113mm) hole ø 6.4mm		
	Part No.	106121	Ref. No. —
	pressure controller natural gas 3.5" W.C.		
	Part No.	580033	Ref. No. 28328
	knob suitable for ROBERTSHAW		

spare parts for	106792		
	Part No.	580033	Ref. No. 28328
	knob suitable for ROBERTSHAW		





1

Part No.	106726	Ref. No.	1174 1174-RS
description	gas valve supply Operator millivolt gas inlet 3/4" NPT gas outlet 3/4" NPT thermocouple connection pilot connection 1/4" CCT type 7000BMVR-LP pressure controller LPG 10"W.C. ROBERTSHAW operator type 82266 output pressure 24.9mbar 700mV		
For models:	Fryer-Filter-System-Series, IF-25-Series-Fryers, IF-75-Series-Fryers, IF-BL-Basketlift-System-Series-Fryers, IF-Series-Fryers		
spare parts for	106726		
	Part No.	101393	Ref. No. —
	blank plate LPG suitable for ROBERTSHAW		
	Part No.	101421	Ref. No. —
	operator LPG 705-50A 82952 supply Operator millivolt		
	Part No.	106109	Ref. No. 28282
	locking screw thread 7/16"-24 UNS for pipe ø 1/4" L 16mm brass Qty 1 pcs WS 7/16" (11.113mm) hole ø 6.4mm		
	Part No.	580033	Ref. No. 28328
	knob suitable for ROBERTSHAW		



1

Part No.	106792	Ref. No.	1173 1173-RS
description	gas valve supply Operator millivolt gas inlet 3/4" NPT gas outlet 3/4" NPT thermocouple connection pilot connection 1/4" CCT type 7000BMVR pressure controller natural gas 4.0" W.C. natural gas output pressure 4"W.C. operator type 82266 output pressure 10mbar		
spare parts for	106792		
	Part No.	101422	Ref. No. —
	operator natural gas supply Operator millivolt		
	Part No.	106109	Ref. No. 28282
	locking screw thread 7/16"-24 UNS for pipe ø 1/4" L 16mm brass Qty 1 pcs WS 7/16" (11.113mm) hole ø 6.4mm		

safety valves

miscellaneous



1

Part No.	106368	Ref. No.	1110-1
description	safety valve BASO type H15HR-3 pressure range 34.5mbar gas inlet 9/16" UNEF (tube ø 9/16") gas outlet 3/8x27 UNF (tube ø 1/4") thermocouple connection 5/32" UNEF 1/2PSI pilot connection 2x 1/4" CCT		



			
1			
Part No.	106367	Ref. No.	1110
description	safety valve ROBERTSHAW type TS11J pressure range 34.5mbar gas inlet 1/4" NPT gas outlet 1/4" NPT thermocouple connection ASA 11/32 1/2PSI pilot connection 2x 3/8" UNF		
For models:	IHR-Series-with-standard-oven, IPRA-and-IPR-Series-Pork-Roaster, IR2000-Series, IR-Series-Medium-Duty-Ranges		

			
1			
Part No.	106348	Ref. No.	1018 1291 1291.018 1292
description	pilot burner ROBERTSHAW type 5CL-2 2 flames natural gas code 18 for pipe ø 3/16" CCT gas connection 3/16" CCTmm nozzle ømm		
For models:	ICMA-Series-Cheesemelter, IDR-Series, IF-Counter-Fryer, IHR-Series-with-standard-oven, IPRA-and-IPR-Series-Pork-Roaster, IR2000-Series, IR-Series-Medium-Duty-Ranges, ISAE-Griddle, ISB-Series-Salander-Broiler, ISCE-Griddle		

ignition parts

pilot burners

ROBERTSHAW

pilot burners

universal series - type 5

			
1			
Part No.	106345	Ref. No.	0316 0316.011 1325
description	pilot burner ROBERTSHAW type 5CHL-6 2 flames LPG code 11 for pipe ø 1/4" CCT gas connection 1/4" CCTmm		
For models:	IF-Counter-Fryer		

			
1			
Part No.	106344	Ref. No.	0316 0316.018 1325
description	pilot burner ROBERTSHAW type 5CHL-6 2 flames natural gas code 18 for pipe ø 1/4" CCT gas connection 1/4" CCTmm		

universal series - type 6

Width of caps:
 6CH10 = 1" (25,4mm)
 6CH14 = 1½" (38,1mm)
 6CH24 = 2½" (63,5mm)
 6CH30 = 3" (76,2mm)

			
1			
Part No.	106347	Ref. No.	1095-16 1095-16.011
description	pilot burner ROBERTSHAW type 6CH14-10 3 flames LPG code 11 for pipe ø 1/4" CCT gas connection 1/4" CCTmm		

			
1			
Part No.	106375	Ref. No.	1095-16 1095-16.016
description	pilot burner ROBERTSHAW type 6CH14-10 3 flames LPG code 16 for pipe ø 1/4" CCT gas connection 1/4" CCTmm		
For models:	IF-25-Series-Fryers, IF-75-Series-Fryers, IF-BL-Basketlift-System-Series-Fryers, IF-Series-Fryers		

Part No.	106346	Ref. No.	0310 0310.022 1095-26
description	pilot burner ROBERTSHAW type 6CH14-10 3 flames natural gas code 22 for pipe ø 1/4" CCT gas connection 1/4" CCTmm		
For models:	IF-25-Series-Fryers, IF-75-Series-Fryers, IF-BL-Basketlift-System-Series-Fryers, IF-Series-Fryers		

universal series with electrodes



Part No.	106349	Ref. No.	1120 1120.018 2139 2139.018
description	pilot burner ROBERTSHAW type 5SL-2 2 flames natural gas code 18 for pipe ø 3/16" CCT		
For models:	IR2000-Series, IR-Serie-Medium-Duty-Ranges, ISAE-Griddle, ISCE-Griddle		

miscellaneous



Part No.	102539	Ref. No.	25001
description	pilot burner IMPERIAL USA 4 complete		
For models:	IHR-Series-with-standard-oven		

electrodes

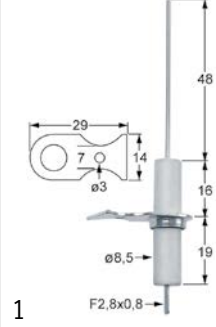

Part No.	106350	Ref. No.	1256
description	ignition electrode flange length 29mm flange width 14mm flange width 2mm D1 ø 8mm L1 48mm BL1 16mm BL2 19mm connection F2.8x0.8 fixing dimensions ø3mm		

ignition cables



Part No.	100197	Ref. No.	1285
description	ignition cable cable length 600mm connection F2.8mm / ø2.4mm		

piezoelectric igniters

mounting diameter 18mm



Part No.	100009	Ref. No.	1075 2080	
description	piezoelectric igniter body plastic blowing mounting ø 18mm connection ø2.4mm front measurements 26mm M18x1.5			
For models:	IR2000-Series, IR-Serie-Medium-Duty-Ranges			
accessories for	100009			
	Part No.	101339	Ref. No.	—
cover cap for piezoelectric igniter				
	Part No.	106869	Ref. No.	—
cover cap for piezoelectric igniter ID ø 22mm ED ø 35mm H 25mm				
	Part No.	107931	Ref. No.	—
cover cap for piezoelectric igniter ID ø 21mm ED ø 36mm				



thermocouples

thermocouple sets universal

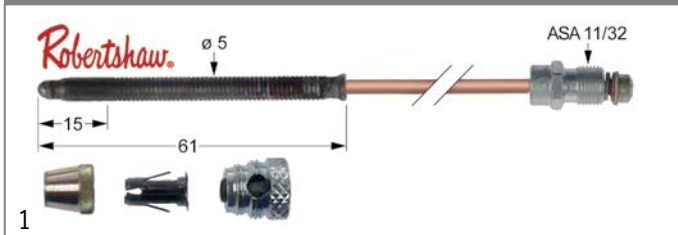

Part No.	107705	Ref. No.	1121-1
description	thermocouple ROBERTSHAW 5-piece L 18" - 455mm ASA 11/32		

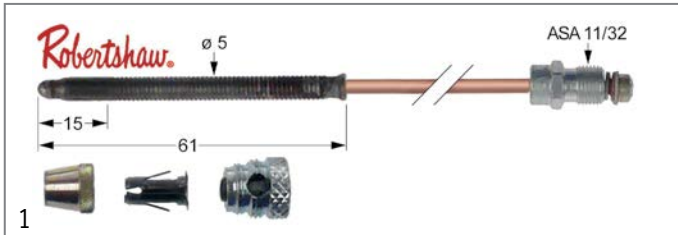

Part No.	107707	Ref. No.	1138
description	thermocouple ROBERTSHAW 5-piece L 30" - 760mm ASA 11/32		
For models:	IHR-Series-with-standard-oven, IR-Serie-Medium-Duty-Ranges		

plug-in thermocouples

plug-in thermocouples standard

ROBERTSHAW

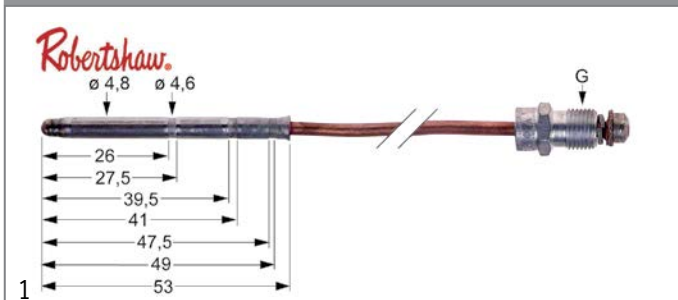

Part No.	102456	Ref. No.	1121 2140
description	thermocouple ASA 11/32 L 12" - 305mm plug connection ø4.8mm		
For models:	IR2000-Series, IR-Serie-Medium-Duty-Ranges		

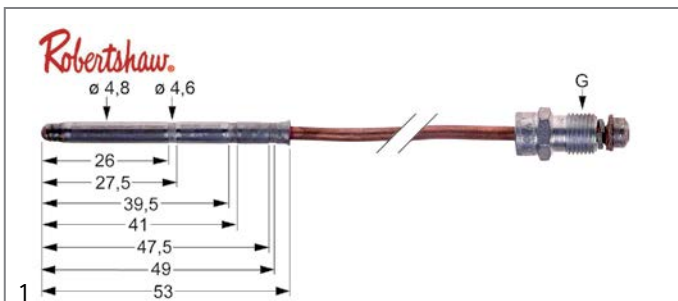

Part No.	102457	Ref. No.	32167
description	thermocouple ASA 11/32 L 30" - 760mm plug connection ø4.8mm		

threaded thermocouples (miscellaneous)



Part No.	102458	Ref. No.	1149 old version
description	thermocouple ASA 11/32 L 24" - 610mm plug connection ø4.8mm		



Part No.	102459	Ref. No.	0230 1265
description	thermocouple ASA 11/32 L 72" - 1825mm plug connection ø4.8mm		



Part No.	103266	Ref. No.	1149
description	thermocouple L 695mm plug connection ø4.8mm		

thermopiles

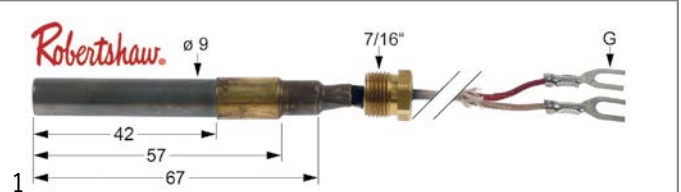

Part No.	102116	Ref. No.	1096
description	thermopile ROBERTSHAW L 900mm probe ø 9mm probe L 57mm 250-750mV screw connection 7/16"		
For models:	IF-25-Series-Fryers, IF-75-Series-Fryers, IF-BL-Basketlift-System-Series-Fryers, IF-Counter-Fryer, IF-Series-Fryers		

gas burners

hob burners

producer-specific hob burners

IMPERIAL USA



Part No.	103027	Ref. No.	2119 2680
description	burner cap ø 117mm with central hole		
For models:	IHPA-Series-Hot-Plate, IR2000-Series		



1

Part No.	104274	Ref. No.	25050
description	burner head ø 155mm front suitable for IHR		
For models:	IHR-Series-with-standard-oven		



1

Part No.	104279	Ref. No.	25051
description	burner head ø 155mm rear suitable for IHR		
For models:	IHR-Series-with-standard-oven		

bar burners

bar burners



1

Part No.	103019	Ref. No.	11350
description	bar burner L 355mm W 155mm ømm H 75mm chargrill		
For models:	EBA-Series-Char-Rock-Broilers		



1

Part No.	103028	Ref. No.	2092-1 2099
description	bar burner L 510mm W 150mm ø 32mm Hmm griddle		



1

Part No.	210023	Ref. No.	1206 5001
description	chargrill grid L 530mm W 127mm H 20mm chargrill		
For models:	EBA-Series-Char-Rock-Broilers, IAB-Series-Steakhouse-Broiler		



1

Part No.	210024	Ref. No.	1207 5003
description	lava rock grid L 385mm W 205mm H 25mm		
For models:	EBA-Series-Char-Rock-Broilers		

chargrill grids



1

Part No.	210023	Ref. No.	1206 5001
description	chargrill grid L 530mm W 127mm H 20mm chargrill		
For models:	EBA-Series-Char-Rock-Broilers, IAB-Series-Steakhouse-Broiler		

lava rock grids



1

Part No.	210024	Ref. No.	1207 5003
description	lava rock grid L 385mm W 205mm H 25mm		
For models:	EBA-Series-Char-Rock-Broilers		

tube burners



1

Part No.	105561	Ref. No.	0305 1225
description	tubular burner L 330mm W 65mm H 56mm fryer oval		
For models:	Fryer-Filter-System-Series, IF-25-Series-Fryers, IF-75-Series-Fryers, IF-BL-Basketlift-System-Series-Fryers, IF-Series-Fryers		





gas nozzles

main nozzles

gas nozzles 3/8" UNF

			
1			
Part No.	106353	Ref. No.	2062
description	gas injector code 39 thread 3/8" UNF bore ø 2.5mm ø 11mm total length 18.5mm WS 13		

			
1			
Part No.	106351	Ref. No.	2059
description	gas injector code 41 thread 3/8" UNF bore ø 2.4mm ø 11mm total length 18.5mm WS 13		

			
1			
Part No.	106376	Ref. No.	1700-43 2062-1
description	gas injector code 43 thread 3/8" UNF bore ø 2.2mm ø 11mm total length 18.5mm WS 13		
For models:	IAB-Series-Steakhouse-Broiler, IHPA-Series-Hot-Plate, IPRA-and-IPR-Series-Pork-Roaster, IR-Series-Elite-Range-Series, ISB-Series-Salamander-Broiler		

			
1			
Part No.	106352	Ref. No.	2067
description	gas injector code 52 thread 3/8" UNF bore ø 1.5mm ø 11mm total length 18.5mm WS 13		

gas nozzles (other)

			
1			
Part No.	102535	Ref. No.	162536
description	gas injector thread 9/16" UNF code 36 WS 9/16" L 55mm natural gas for fryer		
For models:	Fryer-Filter-System-Series, IF-25-Series-Fryers, IF-75-Series-Fryers, IF-BL-Basketlift-System-Series-Fryers, IF-Series-Fryers		

			
1			
Part No.	102529	Ref. No.	162551
description	gas injector thread 9/16" UNF code 51 WS 9/16" bore ø 1.6mm L 42mm LPG for fryer		
For models:	Fryer-Filter-System-Series, IF-25-Series-Fryers, IF-75-Series-Fryers, IF-BL-Basketlift-System-Series-Fryers, IF-Series-Fryers		

pilot burner nozzles

pilot burner nozzles ROBERTSHAW

			
1			
Part No.	100275	Ref. No.	1018 1292 2151
description	pilot burner nozzle LPG code 10 bore ø 0.1mm suitable for ROBERTSHAW		

auxiliary gas parts

screw connections

olives

			
1			
Part No.	101481	Ref. No.	1633 30270
description	olive for pipe ø 1/4" CCT Qty 1 pcs		

			
1			
Part No.	106374	Ref. No.	30280
description	olive for pipe ø 3/16" CCT Qty 1 pcs		

			
1			
Part No.	106355	Ref. No.	30272
description	olive for pipe ø 3/8" CCT Qty 1 pcs		

union nuts

			
1			
Part No.	106354	Ref. No.	30266
description	union nut thread 3/8" CCT WS 16		

			
1			
Part No.	101483	Ref. No.	1633 30735
description	union nut thread 1/4" CCT short		



union screws



1

Part No.	106109	Ref. No.	28282
description	locking screw thread 7/16"-24 UNS for pipe \varnothing 1/4" L 16mm brass Qty 1 pcs WS 7/16" (11.113mm) hole \varnothing 6.4mm		

gas pressure regulators

Standard pressure according to country:
 Germany 50mbar
 France 37mbar
 Italy 30mbar
 Spain 37/50mbar
 UK 20mbar



1

Part No.	106360	Ref. No.	1051 2144 38734
description	gas pressure regulator RV48L input pressure max. 34.5bar output pressure 12.5-29.9mbar input pressure max. 1/2PSI output pressure 5-12"W.C.		
For models:	EBA-Series-Char-Rock-Broilers, GD-Series-Char-Rock-Broilers, ICB-Chicken-Broiler, ICMA-Series-Cheesemelter, ICRA-Series-chinese-range, ICV-and-ICVD-Series, IHR-Series-with-standard-oven, IMGA-Series-Manually-controlled-Griddles, IPRA-and-IPR-Series-Pork-Roaster, IR2000-Series, IRB-Series-Radiant-Char-Broilers, IR-Series-Medium-Duty-Ranges, ISAE-Griddle, ISB-Series-Salamander-Broiler, ISCE-Griddle, ISPA-Series-stock-Pot, ISP-J-Series-Wok, ITG24, ITG36, ITG-Series-Thermostatically-controlled, MSQ-Mesquite-Wood-Broiler		



1

Part No.	106359	Ref. No.	1050 2143 38733
description	gas pressure regulator RV48LS input pressure max. 34.5bar output pressure 7.5-15mbar input pressure max. 1/2PSI output pressure 3-6"W.C. natural gas thread 3/4" NPT		
For models:	EBA-Series-Char-Rock-Broilers, GD-Series-Char-Rock-Broilers, ICB-Chicken-Broiler, ICMA-Series-Cheesemelter, ICRA-Series-chinese-range, ICV-and-ICVD-Series, IHPA-Series-Hot-Plate, IHR-Series-with-standard-oven, IMGA-Series-Manually-controlled-Griddles, IPRA-and-IPR-Series-Pork-Roaster, IR2000-Series, IRB-Series-Radiant-Char-Broilers, IR-Series-Medium-Duty-Ranges, ISAE-Griddle, ISB-Series-Salamander-Broiler, ISCE-Griddle, ISPA-Series-stock-Pot, ISP-J-Series-Wok, ITG24, ITG36, ITG-Series-Thermostatically-controlled, MSQ-Mesquite-Wood-Broiler		

gas ball valves

miscellaneous



1

Part No.	106365	Ref. No.	0344 1623
description	ball valve straight lever handle inlet 1 1/4"NPT outlet 1 1/4"NPT DN32 L 84mm gas IT 1/4"NPT		
For models:	IF-25-Series-Fryers, IF-75-Series-Fryers, IF-BL-Basketlift-System-Series-Fryers, IF-Series-Fryers		



1

Part No.	106364	Ref. No.	0345 0353 1281
description	ball valve straight lever handle inlet 1"NPT outlet 1"NPT DN25 L 70mm gas		
For models:	IF-Counter-Fryer		



gas lines

pilot tubes

universal



Part No.	106358	Ref. No.	2102
description	gas line aluminium pipe ø 3/8" CCT L 285mm		



Part No.	106357	Ref. No.	2105 3061
description	pilot tube aluminium pipe ø 1/4" CCT L 300mm		



Part No.	106356 ¹	Ref. No.	2101 2101-35 3058
description	pilot tube aluminium pipe ø 3/16" CCT Lmm		

¹by the meter

consumables

lava rocks / ceramic briquetts



Part No.	211003	Ref. No.	8092
description	lava rocks size ca.40-120mm Qty 9kg		

equipment-specific units

for deep fryers

lids



Part No.	695177	Ref. No.	28085
description	lid suitable for for fryer L 620mm W 390mm		
For models:	IF-BL-Basketlift-System-Series-Fryers, IF-Series-Fryers		

spare parts and accessories



Part No.	691771	Ref. No.	0308 28026
description	diffuser SS L 390mm W 110mm H 50mm		
For models:	Fryer-Filter-System-Series, IF-25-Series-Fryers, IF-BL-Basketlift-System-Series-Fryers, IF-Series-Fryers		

door magnets



Part No.	690424	Ref. No.	0335 1830
description	door magnet L 57mm W 21mm H 9mm		
For models:	Fryer-Filter-System-Series, IF-25-Series-Fryers, IF-75-Series-Fryers, IF-Series-Fryers		

sumps



Part No.	691776	Ref. No.	28005
description	sump for fryer suitable for IMPERIAL USA IF-series with 3 burner chambers		
For models:	IF-BL-Basketlift-System-Series-Fryers, IF-Series-Fryers		



miscellaneous



1

Part No.	691779	Ref. No.	28269
description	bridge for fryer L 600mm W 37mm H 39mm		
For models:	IF-25-Series-Fryers		



1

Part No.	691778	Ref. No.	28210
description	bridge for fryer SS L 620mm W 48mm H 50mm		
For models:	Fryer-Filter-System-Series		



1

Part No.	541601	Ref. No.	24119 30864
description	drain pipe L 177mm thread 1"NPT		
For models:	IF-Counter-Fryer		



1

Part No.	541602	Ref. No.	30647M
description	drain pipe ø 1 1/4"NPTmm L 127mm		

for ovens

doors



1

Part No.	691773	Ref. No.	2688
description	oven door W 750mm H 455mm thickness 50mm		
For models:	IR2000-Series		

knobs

producer-specific knobs

IMPERIAL USA



1

Part No.	112317	Ref. No.	2730
description	knob gas tap with ignition flame t.max.°F°F ø 63mm shaft ø 9x6mm shaft flat lower blue		





1

Part No.	112318	Ref. No.	0260-1 2733
description	knob gas tap with ignition flame t.max.°F°F ø 63mm shaft ø 9x6mm shaft flat lower blue		







			
1			
Part No.	112302	Ref. No.	2731
description	knob gas tap with ignition flame t.max.°F°F ø 64mm shaft ø 9x6mm shaft flat lower blue		

			
1			
Part No.	112554	Ref. No.	1151L/S
description	knob gas thermostat t.max. 500°F 250-500°F ø 49mm shaft ømm shaft flat ROBERTSHAW black		

			
1			
Part No.	112605	Ref. No.	1107
description	knob gas thermostat t.max. 400°F 150-400°F ø 49mm shaft ø 17mm black		
For models:	IHR-Series-with-standard-oven		

			
1			
Part No.	112297	Ref. No.	1008 2720 36330
description	knob graduated t.max.°F°F ø 70mm shaft ø 9x6mm shaft flat lower blue		
For models:	IAB-Series-Steakhouse-Broiler, ICMA-Series-Cheesemelter, ICRA-Series-chinese-range, IHPA-Series-Hot-Plate, IHR-Series-with-standardoven, IMGA-Series-Manually-controlled-Griddles, IPRA-and-IPR-Series-Pork-Roaster, IR2000-Series, IRB-Series-Radiant-Char-Broilers, IR-Serie-Medium-Duty-Ranges, IR-Series-Elite-Range-Series, ISB-Series-Salamander-Broiler, ISPA-Series-stock-Pot		

			
1			
Part No.	112735	Ref. No.	1101
description	knob gas thermostat t.max. 400°F 150-400°F ø 49mm shaft ø 17mm black		
For models:	IR2000-Series, IR-Serie-Medium-Duty-Ranges		

			
1			
Part No.	112553	Ref. No.	1009 27051 2721 4054
description	knob ON-OFF t.max.°F°F ø 61mm shaft ø 9x6mm shaft flat upper		
For models:	EBA-Series-Char-Rock-Broilers, GD-Series-Char-Rock-Broilers, ICB-Chicken-Broiler, IHR-Series-with-standard-oven, MSQ-Mesquite-Wood-Broiler		

			
1			
Part No.	112548	Ref. No.	1106 2011
description	knob gas thermostat t.max. 400°F 150-400°F ø 49mm shaft ømm shaft flat ROBERTSHAW		
For models:	ITG24, ITG36, ITG-Series-Thermostatically-controlled		

			
1			
Part No.	112319	Ref. No.	0319-1 1176
description	knob thermostat t.max. 400°F 200-400°F ø 57mm shaft ø 6x5mm shaft flat lower black		
For models:			

			
1			
Part No.	112547	Ref. No.	1151 2131
description	knob gas thermostat t.max. 500°F 200-500°F ø 49mm shaft ømm shaft flat ROBERTSHAW black		
For models:	IPRA-and-IPR-Series-Pork-Roaster, IR2000-Series, IR-Serie-Medium-Duty-Ranges		



accessories

rosettes



1

Part No.	112549	Ref. No.	1103
description	rosette for knob ø 60mm up to ø 50mm		
For models:	IPRA-and-IPR-Series-Pork-Roaster, IR2000-Series, IR-Series-Medium-Duty-Ranges		



1

Part No.	112555	Ref. No.	1103L/S
description	rosette for knob ø 60mm up to ø 50mm		

hinges

oven hinges



1

Part No.	691772	Ref. No.	20161
description	oven hinge W 700mm		
For models:	IDR-Series, IHR-Series-with-standard-oven, IR2000-Series, IR-Series-Medium-Duty-Ranges		

door bearing



1

Part No.	691769	Ref. No.	28050
description	hinge L 20mm W 15mm H 52mm mounting pos. left		
For models:	IF-25-Series-Fryers, IF-75-Series-Fryers, IF-BL-Basketlift-System-Series-Fryers, IF-Counter-Fryer, IF-Series-Fryers		



1

Part No.	691770	Ref. No.	28048
description	hinge L 20mm W 15mm H 52mm mounting pos. right		
For models:	IF-25-Series-Fryers, IF-75-Series-Fryers, IF-BL-Basketlift-System-Series-Fryers, IF-Counter-Fryer, IF-Series-Fryers		

filters

deep fryer filters



1

Part No.	691774	Ref. No.	28209 3056-1
description	paper filter W 315mm L 595mm Qty 100 pcs for fryer		
For models:	Fryer-Filter-System-Series		



1

Part No.	691775	Ref. No.	28370 3056
description	paper filter W 410mm L 695mm Qty 100 pcs for fryer		

miscellaneous

with fixing plate

ø125mm



1

Part No.	700012	Ref. No.	1060 2502
description	swivel castor ø 125mm plates fixing 93x61mm housing steel plate size 92x60mm hole distance 73x43mm capacity 100kg bearing ball bearing wheel body polypropylene tread TPE tyres H 152mm wheel width 30mm -20 up to +60°C Qty 1 pcs		
For models:	IDR-Series, IHR-Series-with-standard-oven, IR2000-Series, IR-Series-Medium-Duty-Ranges		



1

Part No.	700819 ¹	Ref. No.	1061
description	swivel castor with brake ø 125mm plates fixing 93x61mm housing steel hole distance 73x43mm wheel width 30mm		
For models:	IDR-Series, IHR-Series-with-standard-oven, IR2000-Series, IR-Series-Medium-Duty-Ranges		

¹with swivel brake



baskets

fryer baskets

US producers



Part No.	970637	Ref. No.	2036 3079
description	fryer basket L1 330mm W1 315mm H1 135mm L2 275mm H2 210mm H3 240mm		
For models:	Fryer-Filter-System-Series, IF-BL-Basketlift-System-Series-Fryers, IF-Series-Fryers		



Part No.	970636	Ref. No.	0362 2035 2050
description	fryer basket L1 340mm W1 170mm H1 150mm L2 295mm H2 240mm H3 300mm		
For models:	Fryer-Filter-System-Series, IF-25-Series-Fryers, IF-BL-Basketlift-System-Series-Fryers, IF-Series-Fryers		

crumb screens

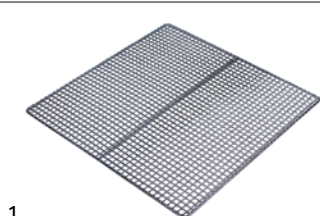

Part No.	970640	Ref. No.	2038
description	crumb screen L 335mm W 342mm		
For models:	Fryer-Filter-System-Series, IF-BL-Basketlift-System-Series-Fryers, IF-Series-Fryers		

shelves and shelf rails

chargrill grids



Part No.	210023	Ref. No.	1206 5001
description	chargrill grid L 530mm W 127mm H 20mm chargrill		
For models:	EBA-Series-Char-Rock-Broilers, IAB-Series-Steakhouse-Broiler		

grates

universal

with upstand



Part No.	970639	Ref. No.	2021
description	grate W 530mm D 670mm chrome-plated steel for oven crossing wires 1		
For models:	IR-Serie-Medium-Duty-Ranges		

producer-specific



Part No.	970638	Ref. No.	2120 4037-3
description	grate W 550mm D 640mm chrome-plated steel for oven		
For models:	IR2000-Series		



consumables

lava rocks / ceramic briquetts



1

Part No.	211003	Ref. No.	8092
description	lava rocks size ca.40-120mm Qty 9kg		

GASTROPARTS.COM

