



GASTROPARTS

Imperial Germany

- [EN]** Equipment
- [DE]** Geräte
- [ES]** Aparatos
- [FR]** Équipement
- [IT]** Attrezzature
- [PL]** Urządzenia
- [RU]** Оборудование

✉ gastroparts@gastroparts.com

☎ +48 56 657 00 66

📘 fb.com/gastroparts.global

GASTROPARTS.COM





heating elements

heating elements for fryers

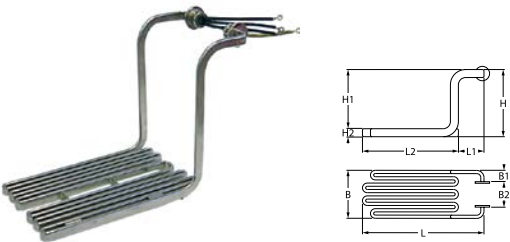

1

Part No.	415745	Ref. No.	8019117
description	heating element 6000W 400V heating circuits 3 L 365mm W 180mm H 246mm L1 85mm L2 280mm H1 230mm H2 16mm W1 50mm W2 80mm windings 6 flange ø 40mm connection cable length 140mm rotation flange immersion heater		

heating elements for convection



1

Part No.	418886	Ref. No.	0001/08065794
description	heating element 18000W 380V heating circuits 3 ID ø 380mm ED ø 393mm L 435mm H 120mm L1 50mm H1 15mm thread M14x1.5 screw mounting tube ø 6.5mm convection heating element		



1

Part No.	416405	Ref. No.	8346760
description	heating element 2400W 230V heating circuits 1 ID ø 190mm ED ø 204mm L 216mm H 30mm L1 5mm W1 25mm H1 10mm H2 20mm flange length 70mm flange width 22mm hole distance 56mm connection male faston 6.3mm connection length 50mm tube ø 6.5mm mounting thread M4 rectangular flange		

thermostats

control and safety thermostats

EGO

control thermostats

55.34_ series

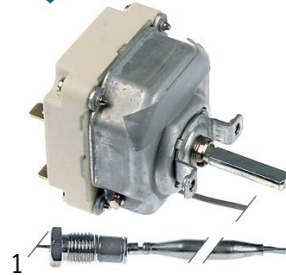

Part No.	375735	Ref. No.	8018402
description	thermostat t.max. 180°C temperature range 100-180°C 3-pole 3NO 16A probe ø 6mm probe L 133mm capillary pipe 2300mm capillary pipe isolated 450mm gland nut M9x1 shaft ø 6x4.6mm shaft L 23mm shaft position upper rotation 270°		

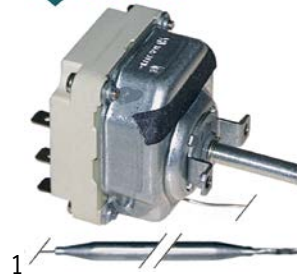

Part No.	375038	Ref. No.	0001/0801888 18882	
description	thermostat t.max. 300°C temperature range 50-300°C 3-pole 3NO 16A probe ø 6mm probe L 79mm capillary pipe 1740mm capillary pipe isolated 800mm gland nut shaft ø 6x4.6mm shaft L 23mm shaft position upper rotation 270°			
accessories for	375038			
	Part No.	110123	Ref. No.	—
	knob thermostat t.max. 300°C ø 50mm shaft ø 6x4.6mm shaft flat upper black temperature range 50-300°C rotation 270°			



safety thermostats

55.31_ series

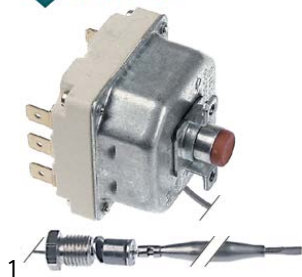

Part No.	375734	Ref. No.	8017428
description	safety thermostat switch-off temp. 260°C 3-pole 20A probe ø 6mm probe L 219mm capillary pipe 2250mm capillary pipe isolated 800mm gland nut M9x1 probe SS		

55.32_ series



Part No.	375942	Ref. No.	08021331 8222310
description	safety thermostat switch-off temp. 156°C 3-pole probe ø 4mm probe L 130mm capillary pipe 900mm capillary pipe isolated 800mm gland nut		

55.33_ series



Part No.	390675	Ref. No.	8038266
description	safety thermostat switch-off temp. 230°C 3-pole 20A probe ø 6mm probe L 88mm capillary pipe 2200mm capillary pipe isolatedmm gland nut probe		

INVENSYS / ROBERTSHAW

control thermostats



Part No.	390636	Ref. No.	1175
description	thermostat t.max. 204°C temperature range 93-204°C 1-pole 1NO 0.67A probe ø 9.5mm probe L 123mm capillary pipe 915mm capillary pipe isolatedmm gland nut 1/4" NPT shaft ø 6x4.6mm shaft L 21mm shaft position lower rotation 315° probe material nickel-plated probe thread 1/4" US		

safety thermostats

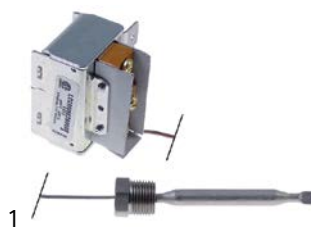

Part No.	390639	Ref. No.	1177
description	safety thermostat switch-off temp. 232°C 1-pole 1COA probe ø 7.9mm probe L 77mm capillary pipe 914mm capillary pipe isolatedmm gland nut 3/8" NPT shaft ømm probe SS 450°F		

switches and momentary switches

cam switches

on/off



Part No.	300129	Ref. No.	08016200
description	cam switch 2 operating positions 2NO sequence 0-1 16A shaft ø 6x4.6mm shaft L 23mm connection male faston 6.3mm ceramic		



4-position



1

Part No.	300103	Ref. No.	5931
description	cam switch 4 operating positions 1NO/2CO sequence 0-1-2-3 32A shaft ø 6x4.6mm shaft L 23mm connection screw ceramic		

contactors

MOELLER/EATON

power contactors



1

Part No.	380694	Ref. No.	8023224
description	power contactor resistive load 35A 230VAC (AC3/400V) 17A/7.5kW main contacts 3NO auxiliary contacts 1NO connection screw connection type DILM 17-10		

gas taps



PEL



















22S/V series



1

Part No.	101457	Ref. No.	8347920
description	gas tap alternatives to JUNKERS type CH110 gas inlet M20x1.5 (tube ø 12mm) bypass nozzle ø 0.35mm gas outlet M20x1.5 (tube ø 12/10mm) thermocouple connection M8x1 pilot connection M10x1 shaft ø 10mm shaft L 25mm shaft flat with pipe outlet		













spare parts for	101457		
	Part No.	100259	Ref. No. —
	bypass nozzle type PEL22 bore ø 0.35mm thread M6x0.5		
	Part No.	100908	Ref. No. —
	union screw thread M10x1 for pipe ø 4mm Qty 1 pcs		
	Part No.	101058	Ref. No. —
	magnet unit L 39mm D1 ø 15.4mm D2 ø 13.5mm suitable for PEL22/EGA24197 standard		

spare parts for	101457		
	Part No.	101200	Ref. No. —
	gas tap front part shaft ø 10mm shaft L 25mm shaft flat suitable for 22S/O		
	Part No.	101230	Ref. No. —
	thermocouple nut T1: M8x1 T2: M18x1 aluminium		
	Part No.	101241	Ref. No. —
	gas connection thread M20x1.5 tube ø 12/10mm for PEL gas taps vertical		
	Part No.	101246	Ref. No. —
	olive for pipe ø 4mm Qty 1 pcs		
	Part No.	101460	Ref. No. —
	O-ring ø 12.37mm D1 ø 2.62mm suitable for PEL22		
	Part No.	101461	Ref. No. —
	screw kit suitable for PEL22 Qty 4 pcs		
accessories for	101457		
	Part No.	100945	Ref. No. —
	roll pin ø 3.2mm L 10mm		
	Part No.	101218	Ref. No. —
	shaft extension JUNKERS		
	Part No.	101219	Ref. No. —
	shaft extension L 25mm JUNKERS		
	Part No.	101231	Ref. No. —
	thermocouple nut T1: M9x1 T2: M18x1		
	Part No.	101248	Ref. No. —
	olive for pipe ø 12mm Qty 1 pcs suitable for PEL		
	Part No.	101249	Ref. No. —
	olive for pipe ø 10mm Qty 1 pcs		
	Part No.	101250	Ref. No. —
	union nut thread M20x1.5 for pipe ø 10mm		
	Part No.	101251	Ref. No. —
	union nut thread M20x1.5 for pipe ø 12mm		
	Part No.	101290	Ref. No. —
	thermocouple nut T1: M10x1 T2: M18x1 suitable for PEL20/21		
	Part No.	110064	Ref. No. —
	knob		
	Part No.	110066	Ref. No. —
	knob screw		
	Part No.	550396	Ref. No. —
	shaft extension L 25mm JUNKERS		



23S/V series



Part No.	101630	Ref. No.	08346580
description	gas tap PEL type 23S/V gas inlet 1/2" IT bypass nozzle ø 0.35mm gas outlet 1/2" MT (tube ø 14mm) thermocouple connection M10x1 pilot connection M10x1 shaft ø 10mm shaft L 25mm shaft flat		
spare parts for	101630		
	Part No.	100455	Ref. No. —
	bypass nozzle type PEL23/24 bore ø 0.35mm thread M8x0.5		
	Part No.	101059	Ref. No. —
	magnet unit T1: M10x1 T2: M22x1 L 46mm ø 18mm suitable for PEL23S M10x1		
	Part No.	102767	Ref. No. —
	gas tap front part shaft ø 10mm shaft L 26.5mm shaft flat suitable for PEL23S		
accessories for	101630		
	Part No.	100908	Ref. No. —
	union screw thread M10x1 for pipe ø 4mm Qty 1 pcs		
	Part No.	100909	Ref. No. —
	union screw thread M10x1 for pipe ø 6mm Qty 1 pcs		
	Part No.	100945	Ref. No. —
	roll pin ø 3.2mm L 10mm		
	Part No.	101218	Ref. No. —
	shaft extension JUNKERS		
	Part No.	101219	Ref. No. —
	shaft extension L 25mm JUNKERS		
	Part No.	101246	Ref. No. —
	olive for pipe ø 4mm Qty 1 pcs		
	Part No.	101286	Ref. No. —
	olive ID ø 6mm Qty 1 pcs		
	Part No.	110064	Ref. No. —
	knob		
	Part No.	110066	Ref. No. —
	knob screw		
	Part No.	550396	Ref. No. —
	shaft extension L 25mm JUNKERS		

alternatives to JUNKERS





















Part No.	101457	Ref. No.	8347920
description	gas tap alternatives to JUNKERS type CH110 gas inlet M20x1.5 (tube ø 12mm) bypass nozzle ø 0.35mm gas outlet M20x1.5 (tube ø 12/10mm) thermocouple connection M8x1 pilot connection M10x1 shaft ø 10mm shaft L 25mm shaft flat with pipe outlet		
spare parts for	101457		
	Part No.	100259	Ref. No. —
	bypass nozzle type PEL22 bore ø 0.35mm thread M6x0.5		
	Part No.	100908	Ref. No. —
	union screw thread M10x1 for pipe ø 4mm Qty 1 pcs		
	Part No.	101058	Ref. No. —
	magnet unit L 39mm D1 ø 15.4mm D2 ø 13.5mm suitable for PEL22/EGA24197 standard		
	Part No.	101200	Ref. No. —
	gas tap front part shaft ø 10mm shaft L 25mm shaft flat suitable for 22S/O		
	Part No.	101230	Ref. No. —
	thermocouple nut T1: M8x1 T2: M18x1 aluminium		
	Part No.	101241	Ref. No. —
	gas connection thread M20x1.5 tube ø 12/10mm for PEL gas taps vertical		
	Part No.	101246	Ref. No. —
	olive for pipe ø 4mm Qty 1 pcs		
	Part No.	101460	Ref. No. —
	O-ring ø 12.37mm D1 ø 2.62mm suitable for PEL22		
	Part No.	101461	Ref. No. —
	screw kit suitable for PEL22 Qty 4 pcs		
accessories for	101457		
	Part No.	100945	Ref. No. —
	roll pin ø 3.2mm L 10mm		
	Part No.	101218	Ref. No. —
	shaft extension JUNKERS		
	Part No.	101219	Ref. No. —
	shaft extension L 25mm JUNKERS		
	Part No.	101231	Ref. No. —
	thermocouple nut T1: M9x1 T2: M18x1		
	Part No.	101248	Ref. No. —
	olive for pipe ø 12mm Qty 1 pcs suitable for PEL		
	Part No.	101249	Ref. No. —
	olive for pipe ø 10mm Qty 1 pcs		

Table continues overleaf



accessories for		101457		
Part No.		101250	Ref. No.	—
	union nut	thread M20x1.5 for pipe ø 10mm		
	union nut	thread M20x1.5 for pipe ø 12mm		
	thermocouple nut	T1: M10x1 T2: M18x1 suitable for PEL20/21		
	knob			
	knob screw			
	shaft extension	L 25mm JUNKERS		

accessories for		101630		
Part No.		101286	Ref. No.	—
	olive	ID ø 6mm Qty 1 pcs		
	knob			
	knob screw			
	shaft extension	L 25mm JUNKERS		





				
1				
Part No.	101630	Ref. No.	08346580	
description	gas tap PEL type 23S/V gas inlet 1/2" IT bypass nozzle ø 0.35mm gas outlet 1/2" MT (tube ø 14mm) thermocouple connection M10x1 pilot connection M10x1 shaft ø 10mm shaft L 25mm shaft flat			
spare parts for	101630			
	Part No.	100455	Ref. No.	—
	bypass nozzle	type PEL23/24 bore ø 0.35mm thread M8x0.5		
	Part No.	101059	Ref. No.	—
	magnet unit	T1: M10x1 T2: M22x1 L 46mm ø 18mm suitable for PEL23S M10x1		
	Part No.	102767	Ref. No.	—
	gas tap front part	shaft ø 10mm shaft L 26.5mm shaft flat suitable for PEL23S		
accessories for	101630			
	Part No.	100908	Ref. No.	—
	union screw	thread M10x1 for pipe ø 4mm Qty 1 pcs		
	Part No.	100909	Ref. No.	—
	union screw	thread M10x1 for pipe ø 6mm Qty 1 pcs		
	Part No.	100945	Ref. No.	—
	roll pin	ø 3.2mm L 10mm		
	Part No.	101218	Ref. No.	—
	shaft extension	JUNKERS		
	Part No.	101219	Ref. No.	—
	shaft extension	L 25mm JUNKERS		
	Part No.	101246	Ref. No.	—
	olive	for pipe ø 4mm Qty 1 pcs		

gas valves and ignition boxes

gas control valves

ROBERTSHAW

millivolt controlled valves

				
1				
Part No.	106124	Ref. No.	1173	
description	gas valve supply Operator millivolt gas inlet 3/4" NPT gas outlet 3/4" NPT thermocouple connection pilot connection 1/4" CCT type 7000BMVRL pressure controller natural gas 6.7" W.C.			
spare parts for	106124			
	Part No.	101389	Ref. No.	—
	pressure controller	natural gas suitable for ROBERTSHAW		
	Part No.	101422	Ref. No.	—
	operator	natural gas supply Operator millivolt		
	Part No.	106109	Ref. No.	—
	locking screw	thread 7/16"-24 UNS for pipe ø 1/4" L 16mm brass Qty 1 pcs WS 7/16" (11.113mm) hole ø 6.4mm		
	Part No.	580033	Ref. No.	—
	knob	suitable for ROBERTSHAW		



ignition parts

pilot burners

JUNKERS

CB 502 series

pilot burners



Part No.	100085	Ref. No.	08016964
-----------------	--------	-----------------	----------

description pilot burner JUNKERS type CB502031 natural gas nozzle no.6 gas connection 6mm with primary air

spare parts for	100085
------------------------	--------

	Part No.	100227	Ref. No.	8065689
pilot burner nozzle natural gas gas pressure 25mbar code 6 Qty 1 pcs suitable for JUNKERS CB50203_				

	Part No.	100704	Ref. No.	—
ignition electrode D1 ø 9mm connection M4 D2 ø 11mm L1 17mm L2 17mm BL1 13mm BL2 4mm BL3 22mm				

	Part No.	100909	Ref. No.	—
union screw thread M10x1 for pipe ø 6mm Qty 1 pcs				

	Part No.	101287	Ref. No.	—
olive for pipe ø 6mm Qty 1 pcs				

	Part No.	101292	Ref. No.	—
union screw for igniter suitable for CB 502/505 Qty 1 pcs				

	Part No.	101295	Ref. No.	—
clamping collet for thermocouple suitable for CB 502/505 Qty 1 pcs				

accessories for	100085
------------------------	--------

	Part No.	100220	Ref. No.	—
pilot burner nozzle LPG gas pressure 50mbar code 2 Qty 1 pcs suitable for JUNKERS CB503_				

	Part No.	100221	Ref. No.	—
pilot burner nozzle LPG gas pressure 30mbar code 29 Qty 1 pcs suitable for JUNKERS CB50203_				



	Part No.	100222	Ref. No.	08065690
pilot burner nozzle LPG gas pressure 50mbar code 5 Qty 1 pcs suitable for JUNKERS CB50203_				

	Part No.	100223	Ref. No.	—
pilot burner nozzle natural gas gas pressure 20mbar code 3 Qty 1 pcs suitable for JUNKERS CB503_				

	Part No.	100224	Ref. No.	—
pilot burner nozzle natural gas gas pressure 25mbar code 26 Qty 1 pcs suitable for JUNKERS CB503_				

	Part No.	100225	Ref. No.	—
pilot burner nozzle LPG gas pressure 30mbar code 39 Qty 1 pcs suitable for JUNKERS CB503_				

	Part No.	100226	Ref. No.	—
pilot burner nozzle LPG gas pressure 50mbar code 15 suitable for JUNKERS				

accessories for	100085			
	Part No.	100228	Ref. No.	—
pilot burner nozzle town gas gas pressure 8mbar code 4 Qty 1 pcs suitable for JUNKERS CB50203_				
	Part No.	101281	Ref. No.	—
olive for pipe ø 4mm L 8.7mm Qty 1 pcs suitable for CB 502/503				
	Part No.	101283	Ref. No.	—
union screw thread M10x1 for pipe ø 4mm Qty 1 pcs				

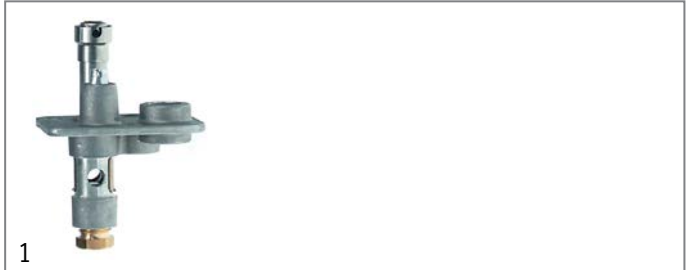

Part No.	102910	Ref. No.	08016964
-----------------	--------	-----------------	----------

description pilot burner JUNKERS type CB502032 natural gas nozzle no.6 gas connection 4mm with primary air

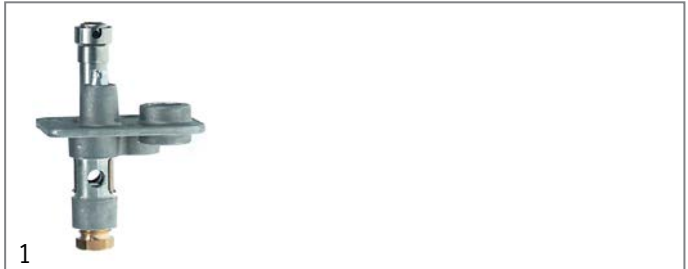



Part No.	100132	Ref. No.	8016964
-----------------	--------	-----------------	---------

description pilot burner JUNKERS type CB502032 town gas nozzle no.4 gas connection 4mm with primary air

spare parts for	100132
------------------------	--------

	Part No.	100227	Ref. No.	8065689
pilot burner nozzle natural gas gas pressure 25mbar code 6 Qty 1 pcs suitable for JUNKERS CB50203_				

	Part No.	101281	Ref. No.	—
olive for pipe ø 4mm L 8.7mm Qty 1 pcs suitable for CB 502/503				

	Part No.	101283	Ref. No.	—
union screw thread M10x1 for pipe ø 4mm Qty 1 pcs				

	Part No.	101295	Ref. No.	—
clamping collet for thermocouple suitable for CB 502/505 Qty 1 pcs				

accessories for	100132
------------------------	--------

	Part No.	100220	Ref. No.	—
pilot burner nozzle LPG gas pressure 50mbar code 2 Qty 1 pcs suitable for JUNKERS CB503_				

	Part No.	100221	Ref. No.	—
pilot burner nozzle LPG gas pressure 30mbar code 29 Qty 1 pcs suitable for JUNKERS CB50203_				

	Part No.	100222	Ref. No.	08065690
pilot burner nozzle LPG gas pressure 50mbar code 5 Qty 1 pcs suitable for JUNKERS CB50203_				

	Part No.	100223	Ref. No.	—
pilot burner nozzle natural gas gas pressure 20mbar code 3 Qty 1 pcs suitable for JUNKERS CB503_				

Table continues overleaf



accessories for		100132	
	Part No.	100224	Ref. No. —
pilot burner nozzle natural gas gas pressure 25mbar code 26 Qty 1 pcs suitable for JUNKERS CB503_			
	Part No.	100225	Ref. No. —
pilot burner nozzle LPG gas pressure 30mbar code 39 Qty 1 pcs suitable for JUNKERS CB503_			
	Part No.	100226	Ref. No. —
pilot burner nozzle LPG gas pressure 50mbar code 15 suitable for JUNKERS			
	Part No.	100228	Ref. No. —
pilot burner nozzle town gas gas pressure 8mbar code 4 Qty 1 pcs suitable for JUNKERS CB50203_			
	Part No.	100292	Ref. No. —
gas injector thread M12x1 WS 14 bore ø 2.10mm			
	Part No.	100704	Ref. No. —
ignition electrode D1 ø 9mm connection M4 D2 ø 11mm L1 17mm L2 17mm BL1 13mm BL2 4mm BL3 22mm			
	Part No.	100909	Ref. No. —
union screw thread M10x1 for pipe ø 6mm Qty 1 pcs			
	Part No.	101287	Ref. No. —
olive for pipe ø 6mm Qty 1 pcs			

CB 503 series

pilot burners

	1		
Part No.	100080	Ref. No.	08003612
description	pilot burner JUNKERS type CB503010 natural gas nozzle no.4 gas connection 4mm		
spare parts for	100080		
	Part No.	100218	Ref. No. —
pilot burner nozzle natural gas gas pressure 15mbar code 6 L 23mm Qty 1 pcs suitable for JUNKERS CB503_ no primary air			
	Part No.	101282	Ref. No. —
olive for pipe ø 4mm L 7.4mm Qty 1 pcs			
	Part No.	101283	Ref. No. —
union screw thread M10x1 for pipe ø 4mm Qty 1 pcs			
accessories for	100080		
	Part No.	100260	Ref. No. —
pilot burner nozzle LPG gas pressure 50mbar code 10 L 20mm Qty 1 pcs suitable for JUNKERS CB503_ no primary air			
	Part No.	100909	Ref. No. —
union screw thread M10x1 for pipe ø 6mm Qty 1 pcs			
	Part No.	101261	Ref. No. —
thermocouple fitting thread M9x1 Qty 1 pcs			
	Part No.	101288	Ref. No. —
olive for pipe ø 6mm L 6mm aluminium Qty 1 pcs ED ø 8.5mm			

ROBERTSHAW

pilot burners

universal series - type 6

Width of caps:
 6CH10 = 1" (25,4mm)
 6CH14 = 1½" (38,1mm)
 6CH24 = 2½" (63,5mm)
 6CH30 = 3" (76,2mm)





Part No.	106346	Ref. No.	1095
description	pilot burner ROBERTSHAW type 6CH14-10 3 flames natural gas code 22 for pipe ø 1/4" CCT gas connection 1/4" CCTmm		

piezoelectric igniters

mounting diameter 18mm



Part No.	100009	Ref. No.	1075
description	piezoelectric igniter body plastic blowing mounting ø 18mm connection ø2.4mm front measurements 26mm M18x1.5		
accessories for	100009		
	Part No.	101339	Ref. No. —
cover cap for piezoelectric igniter			
	Part No.	106869	Ref. No. —
cover cap for piezoelectric igniter ID ø 22mm ED ø 35mm H 25mm			
	Part No.	107931	Ref. No. —
cover cap for piezoelectric igniter ID ø 21mm ED ø 36mm			



thermocouples

plug-in thermocouples

plug-in thermocouples standard

with barrel socket $\varnothing 6\text{mm}$

type Junkers with aluminised tip

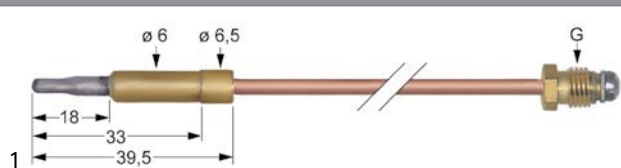

Part No.	102223	Ref. No.	08006062
description	thermocouple M8x1 L 1200mm plug connection $\varnothing 6.0\text{mm}$		

threaded thermocouples (miscellaneous)



Part No.	102459	Ref. No.	1265
description	thermocouple ASA 11/32 L 72" - 1825mm plug connection $\varnothing 4.8\text{mm}$		

thermopiles

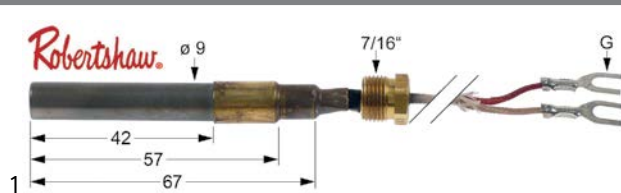

Part No.	102116	Ref. No.	1096
description	thermopile ROBERTSHAW L 900mm probe $\varnothing 9\text{mm}$ probe L 57mm 250-750mV screw connection 7/16"		

gas burners

hob burners

producer-specific hob burners

IMPERIAL GERMANY

universal

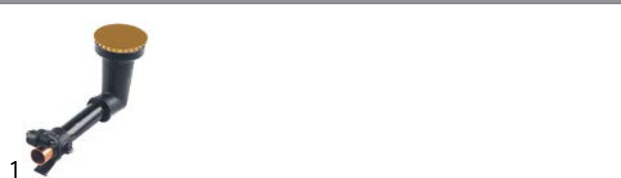

Part No.	105815	Ref. No.	8085064
description	burner $\varnothing 65\text{mm}$ complete		

1			
Part No.	105819	Ref. No.	8085063
description	burner $\varnothing 80\text{mm}$ complete		

1			
Part No.	105823	Ref. No.	8085062
description	burner $\varnothing 95\text{mm}$ complete		

1			
Part No.	105816	Ref. No.	8070178
description	burner cap $\varnothing 65\text{mm}$		

1			
Part No.	105820	Ref. No.	8070179
description	burner cap $\varnothing 80\text{mm}$		

1			
Part No.	105824	Ref. No.	8070180
description	burner cap $\varnothing 95\text{mm}$		

1			
Part No.	105909	Ref. No.	8071670
description	burner head for burner cap $\varnothing 65\text{mm}$		

1			
Part No.	105817	Ref. No.	8085064
description	burner head for burner cap $\varnothing 65\text{mm}$ complete		





			
1			
Part No.	105913	Ref. No.	8070695
description	burner head for burner cap ø 80mm		

			
1			
Part No.	105821	Ref. No.	N/A
description	burner head for burner cap ø 80mm complete		

			
1			
Part No.	105915	Ref. No.	8070697
description	burner head for burner cap ø 95mm		

			
1			
Part No.	105825	Ref. No.	N/A
description	burner head for burner cap ø 95mm complete		

			
1			
Part No.	105818	Ref. No.	8065583
description	burner holder for burner cap ø 65mm		
For models:	GHW4010/1		

			
1			
Part No.	105914	Ref. No.	8070625
description	burner holder for burner cap ø 65mm counterpart		

			
1			
Part No.	105822	Ref. No.	8065585
description	burner holder for burner cap ø 80mm		
For models:	GHW4010/1		

			
1			
Part No.	105911	Ref. No.	8070584
description	burner holder for burner cap ø 80mm counterpart		

			
1			
Part No.	105892	Ref. No.	8065584
description	burner holder for burner cap ø 95mm		
For models:	GHW4010/1		

			
1			
Part No.	105916	Ref. No.	8070624
description	burner holder for burner cap ø 95mm counterpart		

			
1			
Part No.	105910	Ref. No.	8085076
description	burner pipe		

gas nozzles

main nozzles

gas nozzles (other)

			
1			
Part No.	101940	Ref. No.	08071096
description	gas injector T1: M12x1 T2: WS bore ø 0.95mm L 39mm		

pilot burner nozzles

pilot burner nozzles JUNKERS

CB 50203_/503_ series

			
1			
Part No.	100222	Ref. No.	08065690
description	pilot burner nozzle LPG gas pressure 50mbar code 5 Qty 1 pcs suitable for JUNKERS CB50203_		



			
1			
Part No.	100227	Ref. No.	8065689
description	pilot burner nozzle natural gas gas pressure 25mbar code 6 Qty 1 pcs suitable for JUNKERS CB50203_		

bypass nozzles

bypass nozzles PEL23/24

			
1			
Part No.	100627	Ref. No.	08095515
description	bypass nozzle type PEL23/24 bore ø 1mm thread M8x0.5		

knobs

producer-specific knobs

IMPERIAL GERMANY

			
1			
Part No.	111866	Ref. No.	8074759
description	knob gas tap with ignition flame ø 68mm shaft ø 6x4.6mm shaft flat upper black		

			
1			
Part No.	111890	Ref. No.	08074748
description	knob switch 4-position ø 68mm shaft ø 6x4.6mm shaft flat upper black		

baskets

fryer baskets

IMPERIAL GERMANY

			
1			
Part No.	970810	Ref. No.	0036/7205549 37823
description	fryer basket W1 170mm L1 330mm H1 150mm		

GASTROPARTS.COM

