



GASTROPARTS

IME Turbo

[EN] Equipment

[DE] Geräte

[ES] Aparatos

[FR] Équipement

[IT] Attrezzature

[PL] Urządzenia

[RU] Оборудование

✉ gastroparts@gastroparts.com

☎ +48 56 657 00 66

📘 fb.com/gastroparts.global

GASTROPARTS.COM





heating elements

heating elements for fryers

off-center connection

miscellaneous

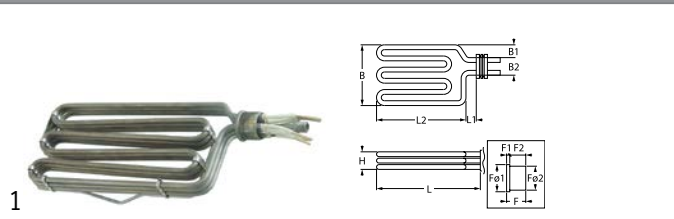

Part No.	415884	Ref. No.	TUR00041620
description	heating element 4500W 230/400V heating circuits 3 mounting pos. left L 272mm W 120mm H 23mm flange length 25mm flange length 1 3mm flange length 2 22mm flange ø1 35mm flange ø2 32mm thermostat sleeves ø 6mm sensor screw connection M12x0.75 thermostat sleeve eccentric L1 15mm L2 259mm W1 20mm W2 80mm tube ø 6.5mm cable length 360mm rotation flange immersion heater fryer connection length 55mm 1		

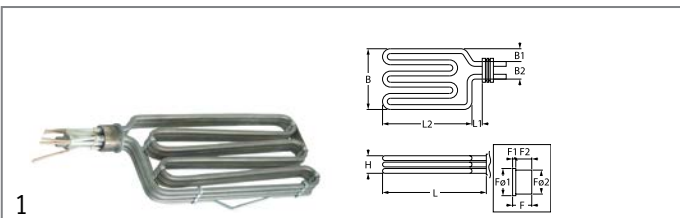

Part No.	415883	Ref. No.	TUR00041619
description	heating element 4500W 230/400V heating circuits 3 mounting pos. right L 272mm W 120mm H 23mm flange length 25mm flange length 1 3mm flange length 2 22mm flange ø1 35mm flange ø2 32mm thermostat sleeves ø 6mm sensor screw connection M12x0.75 thermostat sleeve eccentric L1 15mm L2 255mm W1 20mm W2 80mm tube ø 6.5mm cable length 360mm rotation flange immersion heater with thermostat sensor hole connection length 55mm 1		

accessories for	415883		
	Part No.	101501	Ref. No. —
		nut thread M12x0.75 H 2mm WS 16 brass Qty 1 pcs	

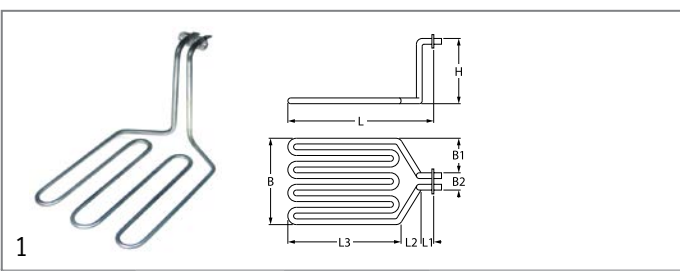

Part No.	418501	Ref. No.	TF8/TF2x8
description	heating element 3000W 230V heating circuits 1 L 280mm W 191mm H 164mm rectangular flange connection male faston 6.3mm L1 15mm L2 35mm L3 230mm W1 80mm W2 31mm hole distance 40mm windings 3 hole ø 4mm flange length 50mm flange width 22mm		

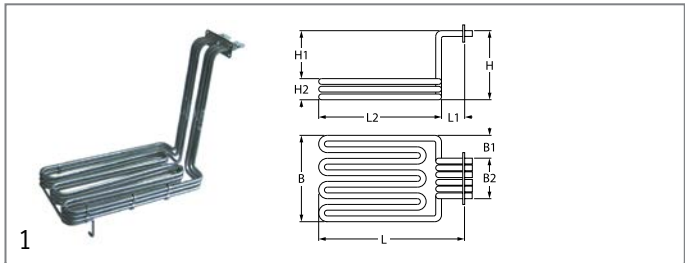

Part No.	415230	Ref. No.	202006
description	heating element 4500W 230/400V heating circuits 3 L 260mm W 115mm H 225mm L1 25mm L2 235mm W1 30mm W2 55mm H1 200mm H2 25mm windings 9 flange length 65mm flange width 25mm hole distance 56mm hole ø 4mm connection male faston 6.3mm tube ø 6.5mm rectangular flange immersion heater		

heating elements for hot counters

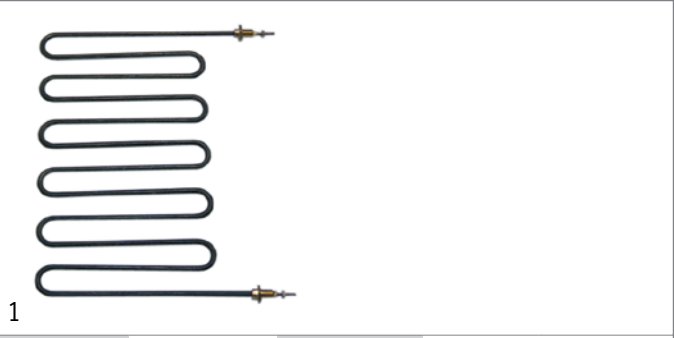

Part No.	415887	Ref. No.	N/A
description	heating element 1750W 230V heating circuits 1 L 232mm W 302mm tube ø 6.3mm connection M4 dry heating element hot bar 2 hole fixing thread M10x1 mounting distance 296mm		

spare parts for	415887		
	Part No.	510416	Ref. No. —
		flat gasket fibre ED ø 19mm ID ø 10.5mm thickness 1.5mm for thread M10 Qty 1 pcs	
accessories for	415887		
	Part No.	510893	Ref. No. —
		O-ring EPDM thickness 2.62mm ID ø 9.92mm Qty 1 pcs	
	Part No.	520231	Ref. No. —
		nut thread M10x1 H 6mm WS 14 zinc-coated steel Qty 1 pcs	
	Part No.	521129	Ref. No. —
		nut thread M10 H 6mm SS WS 17 Qty 1 pcs DIN/ISO DIN 439	

heating elements for refrigeration



Part No.	416351	Ref. No.	TKS0012
description	heating element 160W 230V L 450mm Wmm Hmm connection cable cable length 1700mm tube ø 9mm		

1 electric components



heating elements for condensate evaporation



Part No.	416352	Ref. No.	TKS0319
description	heating element 100W 230V L 550mm W 115mm Hmm cable length 1700mm tube ø 8.5mm condensate evaporation		

heating elements for contact grills





Part No.	415235	Ref. No.	202023
description	heating element 1250W 230V L 195mm W 188mm H 20mm L1 25mm L2 140mm tube ø 8.5mm connection distance 181mm dry heating element windings 3		
accessories for	415235		
	Part No.	550354	Ref. No. —
	terminal bore ø 4.1mm Qty 10 pcs		

heating elements for pizza ovens



Part No.	415826	Ref. No.	990010 IME00005007 TUR 0000 5007
description	heating element 1000W 230V heating circuits 1 L 505mm W 142mm lug length 30mm lug width 16mm connection male faston 6.3mm tube ø 6.3mm bracket mounting hole ø M4mm dry heating element pizza oven		



Part No.	415331	Ref. No.	00005019 202011
description	heating element 1500W 230V L 646mm W 300mm thread M10x1 mounting distance 293mm connection length 15mm connection male faston 6.3mm tube ø 6.3mm heating circuits 1 dry heating element 2 hole fixing		
accessories for	415331		
	Part No.	510416	Ref. No. —
	flat gasket fibre ED ø 19mm ID ø 10.5mm thickness 1.5mm for thread M10 Qty 1 pcs		
	Part No.	510893	Ref. No. —
	O-ring EPDM thickness 2.62mm ID ø 9.92mm Qty 1 pcs		
	Part No.	520231	Ref. No. —
	nut thread M10x1 H 6mm WS 14 zinc-coated steel Qty 1 pcs		

accessories for	415331		
	Part No.	521129	Ref. No. —
	nut thread M10 H 6mm SS WS 17 Qty 1 pcs DIN/ISO DIN 439		

Part No.	415360	Ref. No.	
description	heating element 350W 230V L 560mm W 50mm heating circuits 1 connection male faston 6.3mm tube ø 6.3mm mounting pos. lower connection distance 43mm dry heating element pizza oven		

Part No.	415289	Ref. No.	IME202007
description	heating element 500W 230V L 730mm W 50mm heating circuits 1 connection male faston 6.3mm tube ø 6.5mm dry heating element pizza oven		

heating elements for chargrills

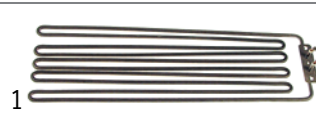

Part No.	415228	Ref. No.	REHEIZK
description	heating element 1100W 220V L 446mm W 127mm H 18mm hole distance 56mm windings 5 W1 47mm W2 32mm flange length 70mm flange width 22mm connection male faston 6.3mm heating circuits 1 tube ø 6.3mm connection length 28mm hole ø 6mm rectangular flange dry heating element		

heating cables

miscellaneous



Part No.	416355	Ref. No.	TKS0025
description	heating cable 50W 230V L 5200mm ø 3mm door frame heating		

Part No.	416354	Ref. No.	TKS0024
description	heating cable L 6200mm door frame heating		

Part No.	416356	Ref. No.	TKS0026
description	heating cable L 6800mm door frame heating		



1 			
Part No.	416353	Ref. No.	TKS0023
description	heating cable on both sides 52W 230V L 4870mm ø 3mm silicone		

quartz heating elements

1 			
Part No.	415236	Ref. No.	205004
description	quartz heating element 400W 110V L 380mm ø 10mm connection male faston 6.3mm		

1 			
Part No.	415237	Ref. No.	205002
description	quartz heating element 533W 75V L 528mm ø 10mm connection male faston 6.3mm		

thermostats

control and safety thermostats

EGO

control thermostats

55.34_ series

			
Part No.	375027	Ref. No.	203017
description	thermostat t.max. 470°C temperature range 50-470°C 3-pole 3NO 16A probe ø 3.9mm probe L 308mm capillary pipe 990mm capillary pipe isolated 800mm gland nut shaft ø 6x4.6mm shaft L 23mm shaft position upper rotation 270°		

refrigeration thermostats

RANCO

K50 series

			
Part No.	390272	Ref. No.	TKS014
description	thermostat RANCO type K50P1117 probe ømm probe Lmm capillary pipe 2000mm temperature range -32 up to -12°C		

			
Part No.	390292	Ref. No.	TKS015
description	thermostat RANCO type K50P1118 probe ømm probe Lmm capillary pipe 1250mm temperature range -3 up to +2.5°C		

switches and momentary switches

microswitches

lever actuated

			
Part No.	345323	Ref. No.	FG08520020 I608520020
description	microswitch with lever 250V 10A 1CO connection male faston ambient temperature max. 105°C		

control equipment

miscellaneous

1 			
Part No.	345288	Ref. No.	201011 201012
description	rotary selector sequence 1-0-2		

lamps

indicator lights

indicator lights (complete)

ø13mm

with plug-in socket

			
Part No.	359143	Ref. No.	231003
description	indicator light ø 13mm yellow 230V connection male faston 6.3mm temp.-resist. 120°C Qty 1 pcs		



25x11mm



1

Part No.	359223	Ref. No.	231001
description	indicator light mounting measurements 25x11mm 230V green connection male faston 6.3mm		



1

Part No.	359224	Ref. No.	231002
description	indicator light mounting measurements 25x11mm 230V yellow connection male faston 6.3mm		





oven lamps

universal oven lamps

mounting diameter 65.5mm



1

Part No.	359712	Ref. No.	02310.02.22	
description	oven lamp mounting ø 65.5mm 230V 40W socket E14 temp.-resist. 300°C connection male faston 6.3mm hard glas			
spare parts for	359712			
	Part No.	359022	Ref. No.	—
	lamp socket socket E14 mounting ø 65.5mm connection male faston 6.3mm			
	Part No.	359611	Ref. No.	—
	light bulb t.max. 300°C socket E14 40W 230V ø 45mm L 75mm lens L 50mm for oven lamp IMPORT			
	Part No.	359722	Ref. No.	—
	gasket silicone ID ø 57.5mm ED ø 68mm thickness 2mm			
	Part No.	359724	Ref. No.	—
	oven lamp glass thread ø 62mm H 46mm ø 74mm hard glas temp.-resist. 350°C			

50x75.5mm



1

Part No.	359309	Ref. No.	23100218
description	oven lamp L 75mm W 50mm 230V 40W socket E14 temp.-resist. 300°C connection male faston 6.3mm		

lamp accessories

lenses

glass panels



1

Part No.	359761	Ref. No.	00005010
description	lamp glass L 70mm W 70mm thickness 4mm pizza oven		

timers

defrost timers

DECO



1

Part No.	360057	Ref. No.	TKS100023
description	defrost timer DECO type S2U2M defrosting interval 2x per 24h defrosting time 0-270min fan delaymin 230V		

MINI T



1

Part No.	360150	Ref. No.	TKS0325
description	switch clock type 3611 defrosting interval 1-48x per 24h defrosting time 15-144 minmin fan delaymin defr. funct. 1-48x per 24h		

electronic controllers

AKO

connection cables



1

Part No.	379243	Ref. No.	TKS0315
description	connection cable L 1000mm suitable for AKO/Universal		



ELIWELL

refrigeration controllers

built-in version



1

Part No.	379114	Ref. No.	TKS0311
-----------------	--------	-----------------	---------

description electronic controller ELIWELL type EWPC961 mounting measurements 71x29mm

accessories

load modules



1

Part No.	379056	Ref. No.	TKS0314
-----------------	--------	-----------------	---------

description load module ELIWELL type EWDR Slave 230V voltage AC

TECNOLOGIC

accessories

connection cables



1

Part No.	379243	Ref. No.	TKS0315
-----------------	--------	-----------------	---------

description connection cable L 1000mm suitable for AKO/Universal

probes

universal probes

temperature probes



1

Part No.	379064	Ref. No.	TKS0313
-----------------	--------	-----------------	---------

description temperature probe PTC 1kOhm cable silicone probe -50 up to +150°C cable -50 up to +180°C probe ø6x40mm cable length 3m without screw connection 2-wire

fans

axial fans

ebm-papst



1

Part No.	601030 ¹	Ref. No.	TKS0122
-----------------	---------------------	-----------------	---------

description axial fan L 119mm W 119mm H 38mm 230VAC 50Hz 18W bearing ball bearing manuf. no. 4656Z metal connection male faston 2.8mm ebm-papst fan wheel ø 110mm temp.-resist. 75°C

accessories for 601030

Part No.	550898	Ref. No.	—
-----------------	--------	-----------------	---

 connecting cable cable length 2000mm connection F 2.8 connection distance 7.9mm for axial flow fan

Part No.	692497	Ref. No.	—
-----------------	--------	-----------------	---

 guard ø 105mm mounting distance 150mm for axial fan ebm-papstmm

¹with ball bearings

refrigeration fans

refrigeration motors universal

IMPORT

multi fit fan motors



1

Part No.	601022	Ref. No.	TKS0002 TKS0003 TKS0004
-----------------	--------	-----------------	-------------------------------

description fan motor 10W 230V 50-60Hz L1 44mm L2 54mm L3 85mm W 84mm cable length 500mm 1300rpm YZF10-20-18/26 5 mounting options bearing slide bearing

WEIGUANG
MOTORS & FANS

1

Part No.	601020	Ref. No.	TKS0002 TKS0003 TKS0004
description	fan motor 5W 230V 50-60Hz L1 44mm L2 48mm L3 79mm W 84mm cable length 500mm 1300rpm YZF5-13-18/26 5 mounting options bearing slide bearing		

cross flow fans

COPREL

with standard coil



1

Part No.	601025	Ref. No.	TKS00020
description	cross flow fan COPREL TFR(FN) roller ø 60mm roller length 180mm laminated core thickness 15mm motor position right 230V/50Hz 19W refrigeration bearing rubber connection male faston 6.3mm coil type airflow 120m³/h -10 up to +60°C		

with moulded coils



1

Part No.	601057	Ref. No.	TKS00112
description	cross flow fan COPREL TFL roller ø 60mm roller length 270mm laminated core thickness 20mm motor position left 230V/50Hz 26W refrigeration bearing rubber connection cable 1500mm coil type moulded -10 up to +60°C		



1

Part No.	601058	Ref. No.	TKS0112
description	cross flow fan COPREL TFL roller ø 60mm roller length 300mm laminated core thickness 20mm motor position left 230V/50Hz 34W refrigeration bearing rubber connection cable 1500mm coil type moulded -10 up to +60°C		

electric accessories

cables

connection cables



1

Part No.	379243	Ref. No.	TKS0315
description	connection cable L 1000mm suitable for AKO/Universal		

terminals

connection terminals with screw/faston connections



1

Part No.	550109	Ref. No.	202026
description	power terminal block 3-pole max. 40A max 250V connection M6/ male faston 6.3mm temp.-resist. 130°C		

gas taps

MADEC (MP)

with pipe outlet



1

Part No.	101074	Ref. No.	N/A
description	gas tap MADEC with pipe outlet gas inlet M12x1 (tube ø 8mm) bypass nozzle ø 0.35mm gas outlet M12x1 (tube ø 8mm) thermocouple connection M8x1 front fixing M12x1 shaft ø 6x4.6mm shaft L 28/21mm shaft flat right		

spare parts for	101074		
Part No.	100360	Ref. No.	—



bypass nozzle MADEC bore ø 0.35mm thread M4.5x0.6 total length 13mm

Part No.	101051	Ref. No.	—
-----------------	--------	-----------------	---



magnet unit L 27mm D1 ø 12.5mm D2 ø 8.5mm suitable for JUNKERS/EGA/MADEC/SABAF standard

Part No.	101234	Ref. No.	—
-----------------	--------	-----------------	---



union nut T1: M8x1 T2: M15



accessories for	101074		
Part No.	100936	Ref. No.	—



gas tap spindle shaft ø 5x8mm MADEC

Table continues overleaf





accessories for		101074	
	Part No.	101277	Ref. No. —
	olive ID ø 8mm Qty 1 pcs		
	Part No.	101296	Ref. No. —
	union nut thread M12x1 for pipe ø 8mm		
	Part No.	101299	Ref. No. —
	nut thread M12x1		
	Part No.	110148	Ref. No. —
	knob gas tap without ignition flame ø 50mm shaft ø 8x5mm shaft flat left black		
	Part No.	110149	Ref. No. —
	knob gas tap without ignition flame t.max.°C temperature range°C ø 50mm shaft ø 6x4.6mm shaft flat right black		
	Part No.	110153	Ref. No. —
	knob gas tap without ignition flame ø 50mm shaft ø 6x4.6mm shaft flat left white		

equipment-specific units

for pizza ovens

firebricks

	1		
Part No.	850048	Ref. No.	00006018
description	firebrick for door		

	1		
Part No.	850049	Ref. No.	00005017
description	firebrick for door		

	1		
Part No.	850041	Ref. No.	426002 TUR00006011
description	firebrick L 600mm W 292mm H 35mm with 2 slits delivery freight forwarding company only		

	1		
Part No.	850045	Ref. No.	P70SCHAMOTT TUR00005021
description	firebrick L 695mm W 345mm H 35mm delivery freight forwarding company only		

for sliding doors

door guides

	1		
Part No.	690483	Ref. No.	I60-LLP-2KT
description	guide bar pair for ZKT		

for toasters

glass panels

	1		
Part No.	690504	Ref. No.	00006017
description	glass panel L 670mm W 240mm thickness 5mm rectangular mounting pos. outer		

knobs

producer-specific knobs

IME-TURBO

	1		
Part No.	110745	Ref. No.	401004
description	knob thermostat t.max. 110°C ø 45mm shaft ø 6x4.6mm shaft flat left silver temperature range 30-110°C		



hinges

edgemount hinges

CHG

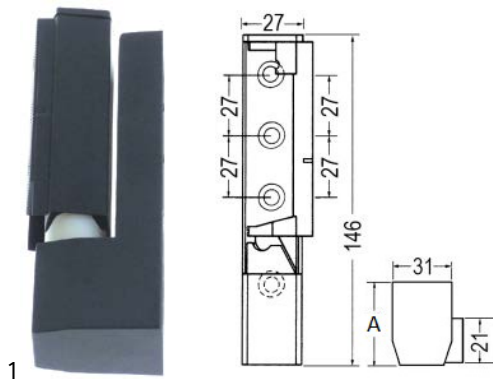

1

Part No.	690299	Ref. No.	GEL1999036 GEL1999037
-----------------	--------	-----------------	--------------------------

description edgemount hinge L 146mm W 31mm mounting distance 27/27mm hinging left/right with gradient L1 45mm mounting pos. right/left black series R50

accessories for 690299



Part No.	345323	Ref. No.	FG08520020 I608520020
-----------------	--------	-----------------	--------------------------

microswitch with lever 250V 10A 1CO connection male faston ambient temperature max. 105°C

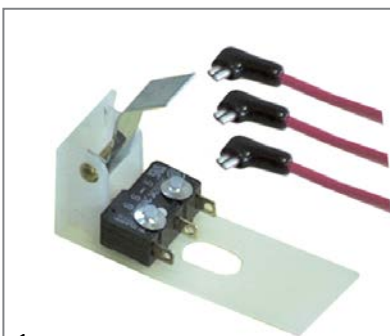

1

Part No.	345323	Ref. No.	FG08520020 I608520020
-----------------	--------	-----------------	--------------------------

description microswitch with lever 250V 10A 1CO connection male faston ambient temperature max. 105°C

pullouts

rollers

rollers



1

Part No.	690802	Ref. No.	KUL00010026
-----------------	--------	-----------------	-------------

description roller rollerø 19mm B1 6mm overall width 8mm A 19mm B 6mm C 8mm D 6mm E 11mm SS tread SS with rivet bore ø 6mm

baskets

fryer baskets

IME-TURBO



1

Part No.	970207	Ref. No.	SOD00010065
-----------------	--------	-----------------	-------------

description fryer basket L1 250mm W1 140mm H1 105mm

gaskets

refrigeration gaskets

plug-in gaskets

profile 9153

We offer custom-made gaskets for this profile

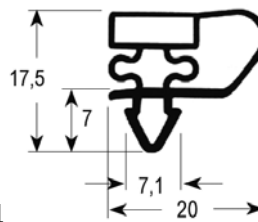

1

Part No.	900210	Ref. No.	TKSCID0033
-----------------	--------	-----------------	------------

description refrigeration gasket profile 9153 W 195mm L 375mm plug size drawer for refrigerated counter refrigeration size 1/3

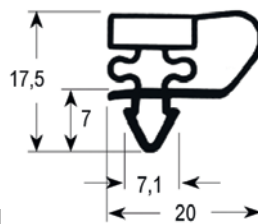

1

Part No.	900214	Ref. No.	TKS0033
-----------------	--------	-----------------	---------

description refrigeration gasket profile 9153 W 202mm L 410mm plug size drawer for refrigerated counter refrigeration size 1/3

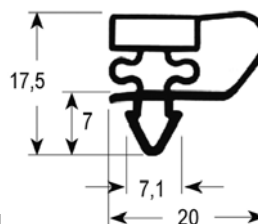

1

Part No.	900215	Ref. No.	TKS0032
-----------------	--------	-----------------	---------

description refrigeration gasket profile 9153 W 317mm L 410mm plug size drawer for refrigerated counter refrigeration size 1/2



Part No.	900211	Ref. No.	TKSCID0032
description	refrigeration gasket profile 9153 W 320mm L 385mm plug size drawer for refrigerated counter refrigeration size 1/2		

Part No.	900212	Ref. No.	TKSCID0034
description	refrigeration gasket profile 9153 W 385mm L 435mm plug size chrome-plated drawer for refrigerated counter refrigeration size 2/3		

Part No.	900213	Ref. No.	TKSCID0031
description	refrigeration gasket profile 9153 W 385mm L 670mm plug size chrome-plated door for refrigerated counter refrigeration size 1/1		

Part No.	900216	Ref. No.	TKS0034
description	refrigeration gasket profile 9153 W 410mm L 437mm plug size drawer for refrigerated counter refrigeration size 2/3		

Part No.	900217	Ref. No.	TKS0031
description	refrigeration gasket profile 9153 W 410mm L 665mm plug size door for refrigerated counter refrigeration size 1/1		

Part No.	902266	Ref. No.	N/A
description	refrigeration gasket profile 9153 Wmm L 2500mm		

profile 9743

We offer custom-made gaskets for this profile

Part No.	900221	Ref. No.	EIS00999001
description	refrigeration gasket profile 9743 W 450mm L 1515mm plug size cell door 500L refrigeration size 1/1		

Part No.	900220	Ref. No.	EIS00999002
description	refrigeration gasket profile 9743 W 450mm L 720mm plug size cell door 500L refrigeration size 1/2		

Part No.	900237	Ref. No.	EIS00999003
description	refrigeration gasket profile 9743 W 580mm L 1520mm plug size cell door 650L refrigeration size 1/1		



Part No.	900236	Ref. No.	EIS00999004
description	refrigeration gasket profile 9743 W 580mm L 730mm plug size cell door 650L refrigeration size 1/2		

Part No.	902304	Ref. No.	N/A
description	refrigeration gasket profile 9743 Wmm L 2500mm		

profile 9951

Part No.	900235	Ref. No.	GEL01999032
description	refrigeration gasket profile 9951 W 464mm L 1530mm external size cell door 550L refrigeration size 1/1		

Part No.	900234	Ref. No.	GEL01999033
description	refrigeration gasket profile 9951 W 464mm L 750mm external size cell door 550L refrigeration size 1/2		

Part No.	900223	Ref. No.	GEL1999034
description	refrigeration gasket profile 9951 W 594mm L 1530mm external size cell door 680L refrigeration size 1/1		

Part No.	900222	Ref. No.	GEL1999035
description	refrigeration gasket profile 9951 W 594mm L 750mm external size cell door 680L refrigeration size 1/2		

profile 9195

We offer custom-made gaskets for this profile

Part No.	901715	Ref. No.	N/A
description	refrigeration gasket profile 9195 W 432mm L 718mm plug size cell door 550L size 1/2		

Part No.	900560	Ref. No.	N/A
description	refrigeration gasket profile 9195 W 562mm L 718mm plug size		



profile 9795

We offer custom-made gaskets for this profile

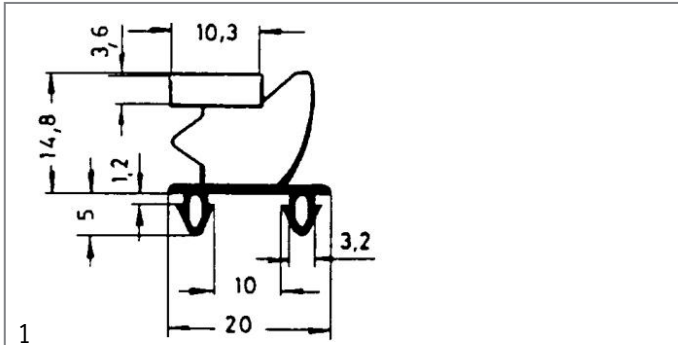

Part No.	900206	Ref. No.	IG0000000003
description	refrigeration gasket profile 9795 W 465mm L 1630mm plug size cell door 600L refrigeration		

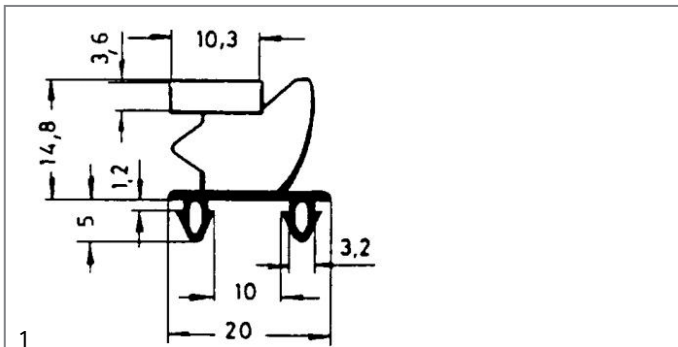

Part No.	900205	Ref. No.	IG0000000001
description	refrigeration gasket profile 9795 W 465mm L 790mm plug size cell door 600L refrigeration		

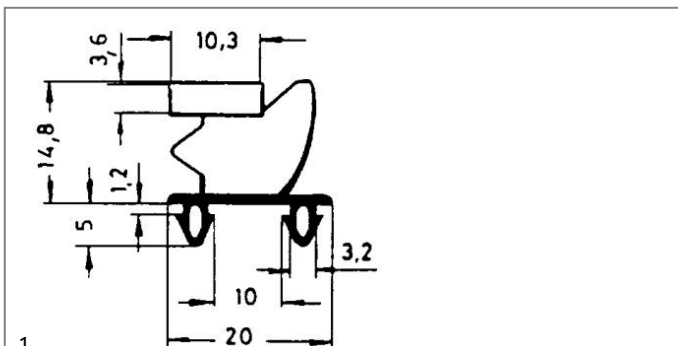

Part No.	900208	Ref. No.	IG0000000002
description	refrigeration gasket profile 9795 W 595mm L 1630mm plug size cell door 700L refrigeration		

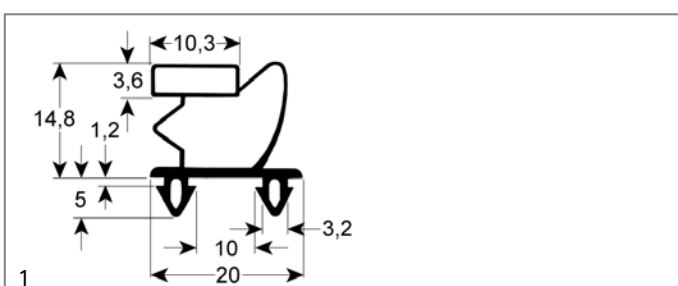

Part No.	900207	Ref. No.	IG0000000004
description	refrigeration gasket profile 9795 W 595mm L 790mm plug size cell door 700L refrigeration		

profile 9956

We offer custom-made gaskets for this profile

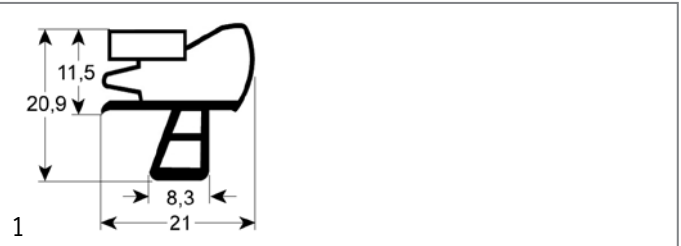

Part No.	900218	Ref. No.	08020.11.40
description	refrigeration gasket profile 9956 W 446mm L 605mm external size saladette door refrigeration		

sealing cords

square



Part No.	900202	Ref. No.	TUR00006016
description	sealing cord square size 11x11mm braided L 1m Qty 1		

evaporators

for fridges

producer-specific



Part No.	750108	Ref. No.	08020.53.90 TKS000393
description	evaporator L 315mm W 150mm H 320mm H2 200mm		

GASTROPARTS.COM

