

# IlSa

- [EN]** Equipment
- [DE]** Geräte
- [ES]** Aparatos
- [FR]** Équipement
- [IT]** Attrezzature
- [PL]** Urządzenia
- [RU]** Оборудование

✉ [gastroparts@gastroparts.com](mailto:gastroparts@gastroparts.com)

☎ +48 56 657 00 66

📘 [fb.com/gastroparts.global](https://fb.com/gastroparts.global)

**GASTROPARTS.COM**







## heating elements

### heating elements for pasta cookers

1 			
<b>Part No.</b>	416671	<b>Ref. No.</b>	R241061
<b>description</b>	heating element 1800W 230V heating circuits 1 L 315mm flange with thread thread 1½" ø 30mm flange ø 70mm flange width 60mm thermostat sleeves ø 6.5mm length thermostat sleeves 255mm cable length 1000mm number of thermostat sleeves 1 pasta cooker thermostat sleeve eccentric, non clinging immersion heater		

1 			
<b>Part No.</b>	416670	<b>Ref. No.</b>	R241050
<b>description</b>	heating element 1800W 230V heating circuits 1 L 315mm Wmm Hmm flange with thread thread 1" ø 30mm flange ø 50mm flange width 45mm cable length 1000mm immersion heater		

1 			
<b>Part No.</b>	416686	<b>Ref. No.</b>	R210061
<b>description</b>	heating element 2500W 230V heating circuits 1 L 490mm flange with thread thread 1½" ø 30mm flange ø 70mm flange width 60mm thermostat sleeves ø 6.5mm length thermostat sleeves 255mm cable length 1000mm number of thermostat sleeves 1 pasta cooker immersion heater		

1 			
<b>Part No.</b>	416685	<b>Ref. No.</b>	R210050
<b>description</b>	heating element 2500W 230V heating circuits 1 L 490mm Wmm Hmm thread 1" ø 30mm flange ø 50mm flange width 45mm cable length 1000mm pasta cooker immersion heater		

### heating cables

#### connection on both sides

#### with wire end ferrules

1 			
<b>Part No.</b>	420385	<b>Ref. No.</b>	29789
<b>description</b>	heating cable 23W 220V L 4500mm for blast chiller		

1 			
<b>Part No.</b>	420388	<b>Ref. No.</b>	27417 R_27417
<b>description</b>	heating cable 26W 230V L 6000mm for blast chiller		

1 			
<b>Part No.</b>	420386	<b>Ref. No.</b>	27957
<b>description</b>	heating cable 32W 220V L 4450mm for blast chiller		

1 			
<b>Part No.</b>	420387	<b>Ref. No.</b>	27956
<b>description</b>	heating cable 37W 220V L 4900mm for blast chiller		

### heating cartridges

1 			
<b>Part No.</b>	416671	<b>Ref. No.</b>	R241061
<b>description</b>	heating element 1800W 230V heating circuits 1 L 315mm flange with thread thread 1½" ø 30mm flange ø 70mm flange width 60mm thermostat sleeves ø 6.5mm length thermostat sleeves 255mm cable length 1000mm number of thermostat sleeves 1 pasta cooker thermostat sleeve eccentric, non clinging immersion heater		

1 			
<b>Part No.</b>	416670	<b>Ref. No.</b>	R241050
<b>description</b>	heating element 1800W 230V heating circuits 1 L 315mm Wmm Hmm flange with thread thread 1" ø 30mm flange ø 50mm flange width 45mm cable length 1000mm immersion heater		

1 			
<b>Part No.</b>	416686	<b>Ref. No.</b>	R210061
<b>description</b>	heating element 2500W 230V heating circuits 1 L 490mm flange with thread thread 1½" ø 30mm flange ø 70mm flange width 60mm thermostat sleeves ø 6.5mm length thermostat sleeves 255mm cable length 1000mm number of thermostat sleeves 1 pasta cooker immersion heater		

1 			
<b>Part No.</b>	416685	<b>Ref. No.</b>	R210050
<b>description</b>	heating element 2500W 230V heating circuits 1 L 490mm Wmm Hmm thread 1" ø 30mm flange ø 50mm flange width 45mm cable length 1000mm pasta cooker immersion heater		

### accessories

#### sealing washers

#### O-rings

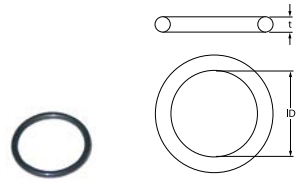
1 			
<b>Part No.</b>	510072	<b>Ref. No.</b>	ID0087
<b>description</b>	O-ring EPDM thickness 3.53mm ID ø 32.93mm Qty 1 pcs		

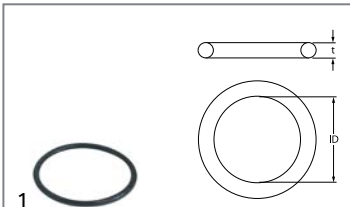
<b>Part No.</b>	532545	<b>Ref. No.</b>	ID0088
<b>description</b>	O-ring Viton thickness 3.53mm ID ø 49.21mm Qty 1 pcs		

## flange gaskets



<b>Part No.</b>	520324	<b>Ref. No.</b>	EL0058
<b>description</b>	counterflange ID ø 160mm ED ø 200mm hole distance 90/180mm hole ø 7mm SS for bottom heaters		
<b>accessories for</b>	520324		
	<b>Part No.</b>	520323	<b>Ref. No.</b> —
	gasket ID ø 160mm ED ø 200mm hole distance 90/180mm hole ø 7mm silicone for bottom heaters		

## counterflanges



<b>Part No.</b>	520324	<b>Ref. No.</b>	EL0058
<b>description</b>	counterflange ID ø 160mm ED ø 200mm hole distance 90/180mm hole ø 7mm SS for bottom heaters		
<b>accessories for</b>	520324		
	<b>Part No.</b>	520323	<b>Ref. No.</b> —
	gasket ID ø 160mm ED ø 200mm hole distance 90/180mm hole ø 7mm silicone for bottom heaters		

## energy regulators

## EGO

## 1-circuit



<b>Part No.</b>	380015	<b>Ref. No.</b>	61137
<b>description</b>	energy regulator 230V 13A single-circuit turn direction right shaft ø 6x4.6mm shaft L 23mm mounting thread M4 power release 6-100% no. 50.57021.010		

## thermostats

## bi-metal thermostats

## bi-metal thermostats

<b>Part No.</b>	390772	<b>Ref. No.</b>	29587
<b>description</b>	bi-metal thermostat hole distance 23.8mm switch-off temp. 110°C 1NC 1-pole 16A 230V connection F6.3		

## control and safety thermostats

## EGO

## control thermostats

## 55.10/19\_ series



<b>Part No.</b>	375237	<b>Ref. No.</b>	60775
<b>description</b>	thermostat t.max. 190°C temperature range 100-190°C 1-pole 1NO 16A probe ø 6mm probe L 130mm capillary pipe 1800mm capillary pipe isolated 1200mm gland nut M9x1 shaft L 23mm shaft position upper rotation 270°		



<b>Part No.</b>	375979	<b>Ref. No.</b>	31482
<b>description</b>	thermostat t.max. 70°C temperature range 30-70°C 1-pole 1NO 16A probe ø 6mm probe L 129mm capillary pipe 900mm capillary pipe isolated 900mm gland nut shaft ø 6x4.6mm shaft L 23mm shaft position upper rotation 270°		



**E-G-O**



1

<b>Part No.</b>	390040	<b>Ref. No.</b>	60780
<b>description</b>	thermostat t.max. 90°C temperature range 30-90°C 1-pole 1CO 16A probe ø 6mm probe L 130mm capillary pipe 2040mm capillary pipe isolated 1940mm gland nut shaft ø 6x4.6mm shaft L 23mm shaft position upper rotation 270° probe material SS		

55.13\_ series

**E-G-O**



1

<b>Part No.</b>	375492	<b>Ref. No.</b>	31229
<b>description</b>	thermostat t.max. 190°C temperature range 94-190°C 1-pole 1NO 16A probe ø 6mm probe L 94mm capillary pipe 1090mm capillary pipe isolated 960mm gland nut M10x1 shaft ø 6x4.6mm shaft L 23mm shaft position upper rotation 310° probe material SS		

55.34\_ series

**E-G-O**



1

<b>Part No.</b>	375362	<b>Ref. No.</b>	843735
<b>description</b>	thermostat t.max. 320°C temperature range 55-320°C 3-pole 3NO 10A probe ø 4mm probe L 128mm capillary pipe 900mm capillary pipe isolatedmm gland nut shaft ø 6x4.6mm shaft L 23mm shaft position upper rotation 270°		

safety thermostats

55.10/19\_ series

**E-G-O**



1

<b>Part No.</b>	375250	<b>Ref. No.</b>	34440
<b>description</b>	safety thermostat capillary pipe 870mm probe ø 6mm 1-pole probe L 129mm 16A capillary pipe isolatedmm gland nut switch-off temp. 130°C probe SS		
<b>spare parts for</b>	375250		
	<b>Part No.</b>	551083	<b>Ref. No.</b> —
	cap for safety thermostat thread M8x1		

**E-G-O**

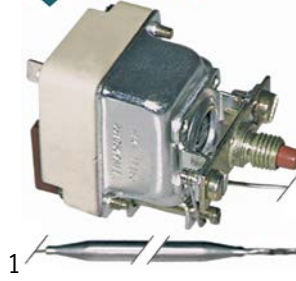

1

<b>Part No.</b>	390062	<b>Ref. No.</b>	60986 821167 R_60986
<b>description</b>	safety thermostat switch-off temp. 235°C 1-pole 0.5A probe ø 6mm probe L 130mm capillary pipe 1800mm capillary pipe isolated 1500mm gland nut M9x1 probe SS		
<b>accessories for</b>	390062		
	<b>Part No.</b>	551083	<b>Ref. No.</b> —
	cap for safety thermostat thread M8x1		

**E-G-O**



1

<b>Part No.</b>	375378	<b>Ref. No.</b>	60761
<b>description</b>	safety thermostat switch-off temp. 350°C 1-pole 16A probe ø 6mm probe L 74mm capillary pipe 900mm capillary pipe isolatedmm gland nut probe SS		
<b>accessories for</b>	375378		
	<b>Part No.</b>	102067	<b>Ref. No.</b> —
	nut thread M8x1 H 3mm brass Qty 1 pcs type SEF 1		

Table continues overleaf



accessories for	375378			
	Part No.	102500	Ref. No.	—
	nut thread M8x1 Qty 10 pcs			

55.31\_ series



<b>Part No.</b>	375104	<b>Ref. No.</b>	5531542120
<b>description</b>	safety thermostat switch-off temp. 230°C 3-pole 20A probe ø 6mm probe L 167mm capillary pipe 830mm capillary pipe isolated 600mm gland nut M10x1 probe		

55.32\_ series



<b>Part No.</b>	376090	<b>Ref. No.</b>	210044 62249
<b>description</b>	safety thermostat switch-off temp. 160°C 3-pole 20A probe ø 6mm probe L 87mm capillary pipe 1490mm capillary pipe isolated 580mm gland nut starting temperature 160°C probe		



<b>Part No.</b>	375375	<b>Ref. No.</b>	31230
<b>description</b>	safety thermostat switch-off temp. 230°C 3-pole 20A probe ø 6mm probe L 94mm capillary pipe 900mm capillary pipe isolated 670mm gland nut M10x1 probe SS		

			
			
<b>Part No.</b>	375393	<b>Ref. No.</b>	60776
<b>description</b>	safety thermostat switch-off temp. 235°C 3-pole 1CO/2NC 20A probe ø 6mm probe L 87mm capillary pipe 1790mm capillary pipe isolated 1710mm gland nut M9x1 probe SS		

			
			
<b>Part No.</b>	375228	<b>Ref. No.</b>	843737
<b>description</b>	safety thermostat switch-off temp. 350°C 3-pole 20A probe ø 3mm probe L 188mm capillary pipe 900mm capillary pipe isolated 900mm gland nut probe SS		

accessories

connecting bows



<b>Part No.</b>	550060	<b>Ref. No.</b>	60340
<b>description</b>	connecting bow long for thermostat Qty 1 pcs		

switches and momentary switches

rocker/momentary rocker switches

25.5x25mm





<b>Part No.</b>	347624 <sup>1</sup>	<b>Ref. No.</b>	00263
<b>description</b>	rocker switch mounting measurements 25x25mm green 2NO 250V 16A illuminated connection male faston 6.3mm ambient temperature max. 85°C protection IP40		

<b>accessories for</b>	347624			
	Part No.	301323	Ref. No.	—
	protective cover external size 35x35mm H 11mm transparent suitable for rocker switch mounting measurements 25.5x25mm L 35mm W 35mm			

<sup>1</sup>illuminated





30x22mm			
			
1			
<b>Part No.</b>	301003	<b>Ref. No.</b>	01382 EL0006
<b>description</b>	rocker switch mounting measurements 30x22mm green 2NO 250V 16A illuminated 0-I connection male faston 6.3mm ambient temperature max. 125/55°C protection IP65		
<b>accessories for</b>	301003		
			
<b>Part No.</b>	301036	<b>Ref. No.</b>	—
<b>description</b>	protective cover internal size 30x22mm for rocker switch mounting measurementsmm		

ø25mm			
			
1			
<b>Part No.</b>	347623	<b>Ref. No.</b>	32760
<b>description</b>	push switch mounting ø 25mm blue 2NO 250V 16A illuminated connection male faston 6.3mm ambient temperature max. 85°C protection IP40		

			
1			
<b>Part No.</b>	345161 <sup>1</sup>	<b>Ref. No.</b>	29583 30656
<b>description</b>	push switch mounting ø 25mm green 2NO 250V 16A illuminated connection male faston 6.3mm ambient temperature max. 85°C protection IP40		

push/momentary push switches

19x13mm			
			
1			
<b>Part No.</b>	347627	<b>Ref. No.</b>	61286 62240
<b>description</b>	momentary push switch mounting measurements 19x13mm black 2NO 250V 16A connection male faston 6.3mm ambient temperature max. 85°C protection IP65 with cover cap		





30x22mm			
			
1			
<b>Part No.</b>	301146	<b>Ref. No.</b>	27783
<b>description</b>	momentary push switch mounting measurements 30x22mm red 2NO 250V 16A illuminated connection male faston 6.3mm ambient temperature max. 125/55°C protection IP40		

			
1			
<b>Part No.</b>	301082	<b>Ref. No.</b>	18686 18869
<b>description</b>	push switch mounting measurements 30x22mm green 2NO 250V 12A connection male faston 6.3mm ambient temperature max. 85/55°C protection IP54 with protective collar		

			
1			
<b>Part No.</b>	301083	<b>Ref. No.</b>	18687 18870
<b>description</b>	push switch mounting measurements 30x22mm orange 2NO 250V 12A connection male faston 6.3mm ambient temperature max. 85/55°C protection IP54 with protective collar		

<sup>1</sup>illuminated

cam switches

7-position			
			
1			
<b>Part No.</b>	300025	<b>Ref. No.</b>	843751
<b>description</b>	cam switch 7 operating positions 1NO/2CO sequence 0-1-2-3-4-5-6 16A shaft ø 6x4.6mm shaft L 23mm connection screw 7-position ceramic		
<b>accessories for</b>	300025		
			
<b>Part No.</b>	112172	<b>Ref. No.</b>	—
<b>description</b>	knob universal ø 70mm black without adaptor/dial plate		
			
<b>Part No.</b>	112213	<b>Ref. No.</b>	—
<b>description</b>	knob dial plate silver switch 7-position t.max.°C ED ø 63mm ID ø 45.5mm		
			
<b>Part No.</b>	112311	<b>Ref. No.</b>	—
<b>description</b>	knob adapter shaft ø 6x4.6mm L 0mm with spring		





## 4 operating positions



1

<b>Part No.</b>	300210	<b>Ref. No.</b>	60773
-----------------	--------	-----------------	-------

**description** cam switch 4 operating positions 4NO sequence 0-1-2-3 16A shaft  $\varnothing$  6x4.6mm shaft L 23mm connection screw ceramic

**accessories for** 300210



<b>Part No.</b>	551456	<b>Ref. No.</b>	—
-----------------	--------	-----------------	---

gasket for switch ED  $\varnothing$  14mm ID  $\varnothing$  2.5mm thickness 3.5mm white



1

<b>Part No.</b>	300200	<b>Ref. No.</b>	60898
-----------------	--------	-----------------	-------

**description** operation switch 2 operating positions 2NO 16A sequence 0-1 shaft  $\varnothing$  6x4.6mm shaft L 23mm connection male faston 6.3mm operation switch ceramic

## rotary switches

## TECNOMATIC



1

<b>Part No.</b>	346102	<b>Ref. No.</b>	R_C8162-00-IN
-----------------	--------	-----------------	---------------

**description** rotary switch 6 2-1-0-3-4-5 sets of contacts 10 type HD12X303R000 600V 12A shaft  $\varnothing$  6mm shaft L 22mm shaft round connection male faston 6.3mm

## magnetic switches

## 65x20mm



1

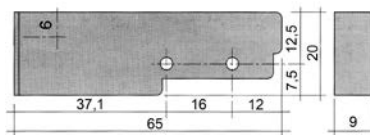

<b>Part No.</b>	345116	<b>Ref. No.</b>	18762
-----------------	--------	-----------------	-------

**description** magnetic switch L 65mm W 20mm 1NO 250V 0.4A P max. 100W connection cable cable length 3000mm

**accessories for** 345116



<b>Part No.</b>	345399	<b>Ref. No.</b>	—
-----------------	--------	-----------------	---

magnet  $\varnothing$  3.3mm L 40mm H 8mm W 13mm hole distance 30mm M3

## operation switches



1

<b>Part No.</b>	300080	<b>Ref. No.</b>	60777
-----------------	--------	-----------------	-------

**description** cam switch 2 operating positions 4NO 16A sequence 0-1 shaft  $\varnothing$  6x4.6mm shaft L 23mm connection screw operation switch ceramic ambient temperature max. 150°C

**accessories for** 300080



<b>Part No.</b>	551456	<b>Ref. No.</b>	—
-----------------	--------	-----------------	---

gasket for switch ED  $\varnothing$  14mm ID  $\varnothing$  2.5mm thickness 3.5mm white



## encoders and potentiometers

 <p>1</p>			
<b>Part No.</b>	402175	<b>Ref. No.</b>	26507
<b>description</b>	potentiometer 100KOhm shaft ø 6x4.6mm thread M10x0.75 cable length 800mm		

## lamps

### indicator lights

#### indicator light lenses



##### ø 6mm (type SQ-20)

 <p>1</p>			
<b>Part No.</b>	359803	<b>Ref. No.</b>	18871
<b>description</b>	indicator light lens green Qty 1 pcs ø 6mm		

 <p>1</p>			
<b>Part No.</b>	359805	<b>Ref. No.</b>	18872
<b>description</b>	indicator light lens red Qty 1 pcs ø 6mm		



##### ø10mm (type SRZ-3)

 <p>1</p>			
<b>Part No.</b>	359228	<b>Ref. No.</b>	60144 EL0030
<b>description</b>	indicator light housings mounting measurements ø10mm clear round Qty 1 pcs		

 <p>1</p>				
<b>Part No.</b>	359123	<b>Ref. No.</b>	60119 EL0028 R60119	
<b>description</b>	indicator light housings mounting measurements ø10mm green round Qty 1 pcs			
<b>accessories for</b>	359123			
	<b>Part No.</b>	359132	<b>Ref. No.</b>	—
	 indicator lamp green 250V connection male faston 6.3mm protection IP54 ambient temperature max. 85°C			

 <p>1</p>			
<b>Part No.</b>	359125	<b>Ref. No.</b>	60120 EL0027 R60120
<b>description</b>	indicator light housings mounting measurements ø10mm red round Qty 1 pcs		

#### indicator lamps for socket type SRZ / SDK / SDY / SFK

 <p>1</p>				
<b>Part No.</b>	359430	<b>Ref. No.</b>	61307 EL0007 R61307	
<b>description</b>	indicator lamp 230V clear connection cable 400mm			
<b>accessories for</b>	359430			
	<b>Part No.</b>	359260	<b>Ref. No.</b>	—
	 indicator light housings mounting measurements ø12mm yellow round Qty 1 pcs			

 <p>1</p>			
<b>Part No.</b>	359431	<b>Ref. No.</b>	60145 R60145
<b>description</b>	indicator lamp 230V green connection cable 400mm cable material silicone		

#### indicator lights (complete)

##### 26.5x25.6mm

 <p>1</p>			
<b>Part No.</b>	357097	<b>Ref. No.</b>	00264
<b>description</b>	indicator light mounting measurements 27.8x25mm yellow 250V connection male faston 6.3mm		

### fluorescent lamps

#### fluorescent lamps

##### G13

 <p>1</p>			
<b>Part No.</b>	359386	<b>Ref. No.</b>	18659
<b>description</b>	fluorescent lamp socket G13 L 1198mm 36W 230V Qty 1 pcs		





## accessories

## ballasts



1

<b>Part No.</b>	401440	<b>Ref. No.</b>	18664
<b>description</b>	electrical ballast 15W 230V for fluorescent lamps		



1

<b>Part No.</b>	401505	<b>Ref. No.</b>	18665
<b>description</b>	electrical ballast 36W 230V Qty 1 pcs		



1

<b>Part No.</b>	401448	<b>Ref. No.</b>	27665
<b>description</b>	electrical ballast 8W for fluorescent lamps		

## timers

## electric timers



1

<b>Part No.</b>	362006	<b>Ref. No.</b>	537019301-LO
<b>description</b>	timer ITS operation time 120min 2NO at 250V 16A permanent position no shaft $\varnothing$ 6x4.6mm shaft L 24mm mounting distance 25mm mounting thread M4 connection 6.3x0.8 ambient temperature max. 125°C		

## contactors

## ALLEN BRADLEY

## power contactors



1

<b>Part No.</b>	380458	<b>Ref. No.</b>	60028
<b>description</b>	power contactor resistive load 20A 230VAC (AC3/400V) 9A/4kW main contacts 3NO auxiliary contacts 1NO connection screw connection type 100-K09KF10		



1

<b>Part No.</b>	381121	<b>Ref. No.</b>	31280
<b>description</b>	power contactor resistive load 32A 230VAC (AC3/400V) 16A/7.5kW main contacts 3NO auxiliary contacts 1NO connection screw connection type 100-C16KF10		

## OMRON

## power contactors



1

<b>Part No.</b>	381227	<b>Ref. No.</b>	63655 R_63655
<b>description</b>	power contactor resistive load 25A 240VAC (AC3/400V) 14A/5.5kW main contacts 3NO auxiliary contacts 1NO connection screw connection type J7KN-14D-10		

## relays

## power relays

## with bracket mounting

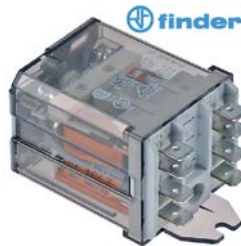

1

<b>Part No.</b>	380139	<b>Ref. No.</b>	26510
<b>description</b>	power relays FINDER 230VAC 16A 2CO connection F6.3 bracket mounting dimensions 68x38.2x35.8mm manuf. no. 62.82.8.230.0000		



## electronic controllers

### CAREL

#### refrigeration controllers

##### built-in version



1

<b>Part No.</b>	378283	<b>Ref. No.</b>	28320 31384 34986 R_34986
<b>description</b>	electronic controller CAREL PYIL1U05B9 mounting measurements 71x29mm built-in depth 74mm 230V voltage AC NTC relay outputs 3 NO-10A(10) CO-12A(2) NO-8A(4) NTC NTC DI yes protection IP54 -50 up to +90°C display 3 digits		
<b>spare parts for</b>	378283		
	<b>Part No.</b>	<b>Ref. No.</b>	20286
	temperature probe NTC 10kOhm cable thermoplastic probe -40 up to +110°C cable -40 up to +110°C probe ø6x14mm cable length 1.5m without screw connection 2-wire		
	<b>Part No.</b>	<b>Ref. No.</b>	29657
	temperature probe NTC 10kOhm cable thermoplastic probe -40 up to +110°C cable -40 up to +110°C probe ø6x14mm cable length 3m without screw connection 2-wire		
	<b>Part No.</b>	<b>Ref. No.</b>	—
	temperature probe NTC 10kOhm cable silicone probe -40 up to +110°C cable -50 up to +180°C probe ø6x40mm cable length 3m 2-wire		
	<b>Part No.</b>	<b>Ref. No.</b>	—
	temperature probe NTC 10kOhm cable silicone probe -40 up to +110°C cable -50 up to +180°C probe ø6x40mm cable length 1.5m without screw connection 2-wire		

## probes

### universal probes

#### temperature probes



<b>Part No.</b>	379160	<b>Ref. No.</b>	20286
<b>description</b>	temperature probe NTC 10kOhm cable thermoplastic probe -40 up to +110°C cable -40 up to +110°C probe ø6x14mm cable length 1.5m without screw connection 2-wire		



<b>Part No.</b>	379161	<b>Ref. No.</b>	29657
<b>description</b>	temperature probe NTC 10kOhm cable thermoplastic probe -40 up to +110°C cable -40 up to +110°C probe ø6x14mm cable length 3m without screw connection 2-wire		



<b>Part No.</b>	379142	<b>Ref. No.</b>	29799
<b>description</b>	temperature probe PTC 1kOhm cable PVC probe -50 up to +150°C cable -10 up to 100°C probe ø6x30mm cable length 1.5m without screw connection 2-wire		



<b>Part No.</b>	379053	<b>Ref. No.</b>	01074 01889 27474
<b>description</b>	temperature probe PTC 1kOhm cable PVC probe -50 up to +150°C cable -10 up to 100°C probe ø6x30mm cable length 3m without screw connection 2-wire		

#### core probes



1

<b>Part No.</b>	379549	<b>Ref. No.</b>	31155
<b>description</b>	core temperature probe PTC 1kOhm cable PVC probe -50 up to +150°C cable -10 up to 100°C probe ø6x110mm cable length 3.5m handle ø 8mm handle length 120x35mm 2-wire L1 120mm L2 130mm		

### producer-specific probes

#### probes



1

<b>Part No.</b>	378289	<b>Ref. No.</b>	26508
<b>description</b>	temperature probe NTC 10kOhm cable PVC probe -40 up to +110°C cable -10 up to 100°C connection 2-wire thread probe ø5x20mm cable length 2m		



core probes

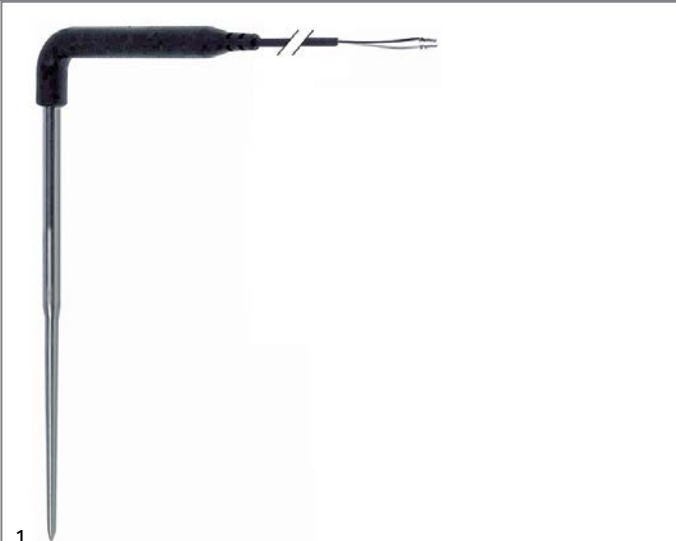

<b>Part No.</b>	379549	<b>Ref. No.</b>	31155
<b>description</b>	core temperature probe PTC 1kOhm cable PVC probe -50 up to +150°C cable -10 up to 100°C probe ø6x110mm cable length 3.5m handle ø 8mm handle length 120x35mm 2-wire L1 120mm L2 130mm		

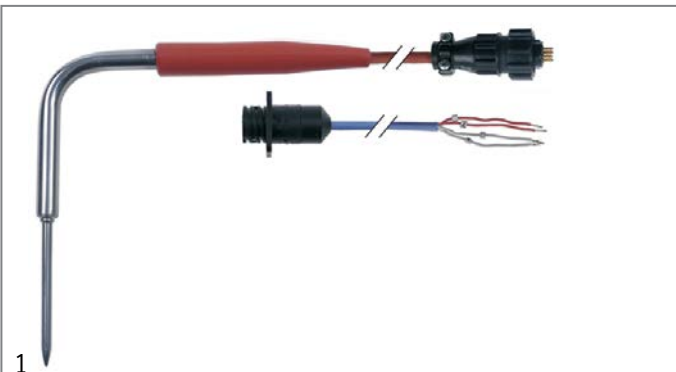

<b>Part No.</b>	379547	<b>Ref. No.</b>	30600
<b>description</b>	core temperature probe PTC 1kOhm cable silicone probe -40 up to +120°C cable -50 up to +180°C connection 4-wire probe ø5x70mm thread cable length 1.2m handle ø 10mm handle length 120mm L1 150mm L2 80mm		



<b>Part No.</b>	378287	<b>Ref. No.</b>	27395
<b>description</b>	core temperature probe PTC 1kOhm cable silicone probe -40 up to +120°C cable -50 up to +180°C connection plug probe ø5x100mm cable length 0.7m L1 70mm L2 120mm		

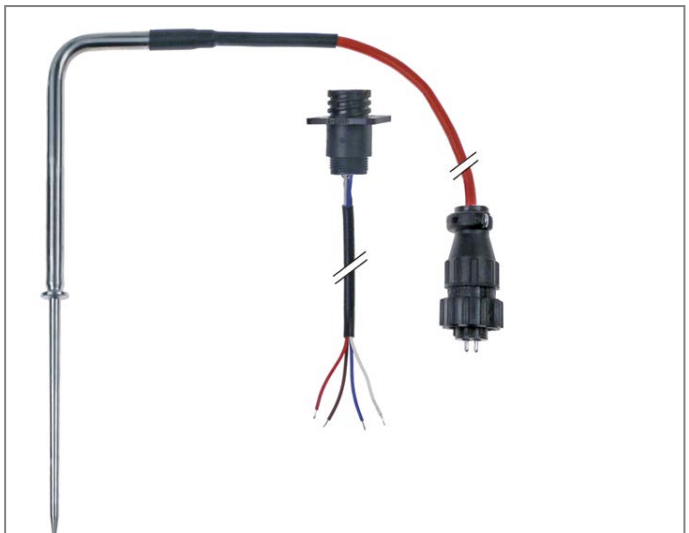

<b>Part No.</b>	378288	<b>Ref. No.</b>	28623
<b>description</b>	core temperature probe PTC 1kOhm cable silicone probe -40 up to +120°C cable -50 up to +180°C connection plug probe ø5x100mm thread cable length 1.2m handle ø 8mm handle length 120/40mm		

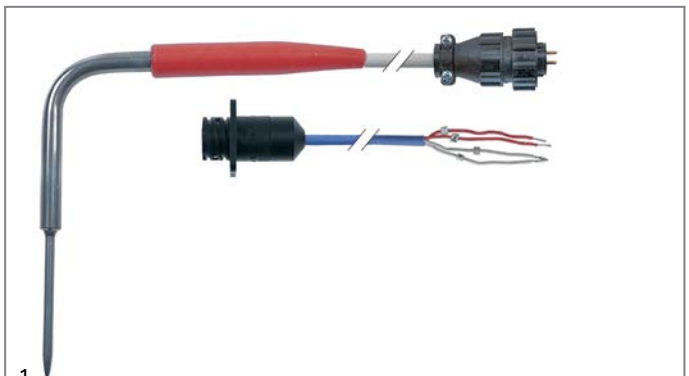

<b>Part No.</b>	379548	<b>Ref. No.</b>	30599
<b>description</b>	core temperature probe PTC 1kOhm cable silicone probe -50 up to +150°C cable -50 up to +180°C connection 4-wire probe ø5x70mm thread cable length 1.2m handle ø 10mm handle length 120mm L1 150mm L2 80mm		

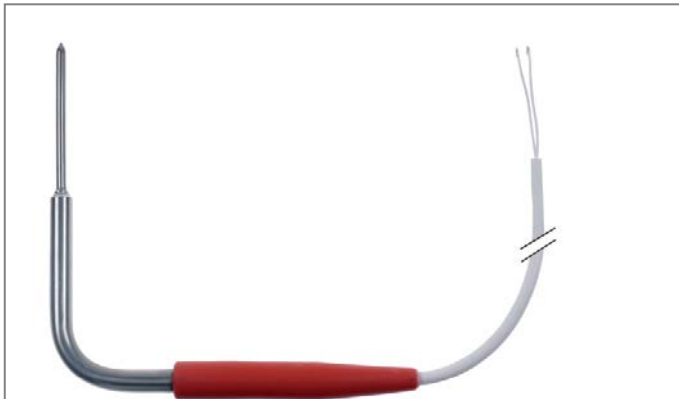

1

<b>Part No.</b>	379791	<b>Ref. No.</b>	31928
<b>description</b>	core temperature probe PTC cable silicone probe -40 up to +120°C cable -50 up to +180°C connection 2-wire probe ø4.5x70mm thread cable length 3m handle ø 16mm handle length 120mm L1 157mm L2 87mm		

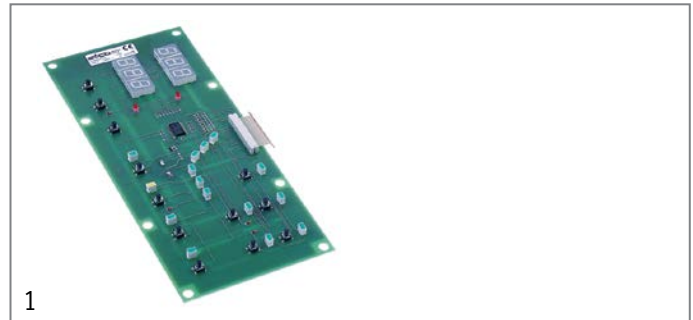

1

<b>Part No.</b>	401779	<b>Ref. No.</b>	28203 R_28203
<b>description</b>	keypad PCB L 252mm W 112mm horizontal		
<b>accessories for</b>	401779		
	<b>Part No.</b>	401782	<b>Ref. No.</b> 28706
<b>description</b>	keypad foil horizontal L 250mm W 110mm		

## electronics

### PCBs

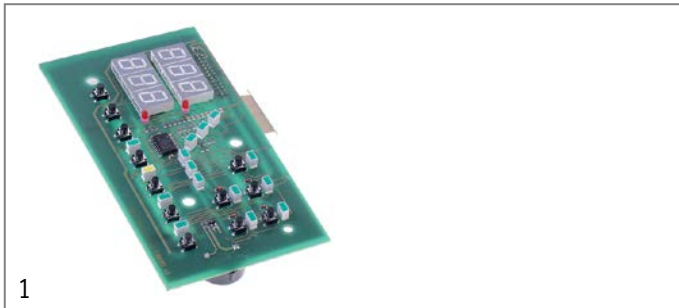

1

<b>Part No.</b>	401780	<b>Ref. No.</b>	28707 31410
<b>description</b>	keypad PCB blast chiller L 160mm W 85mm suitable for ILSA vertical		
<b>accessories for</b>	401780		
	<b>Part No.</b>	401781	<b>Ref. No.</b> 27776
<b>description</b>	keypad foil vertical L 138mm W 68mm		

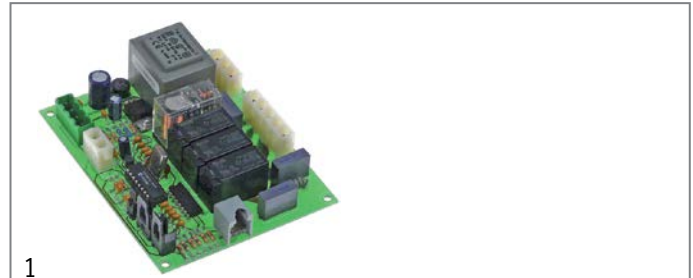

1

<b>Part No.</b>	401873	<b>Ref. No.</b>	26478
<b>description</b>	PCB		

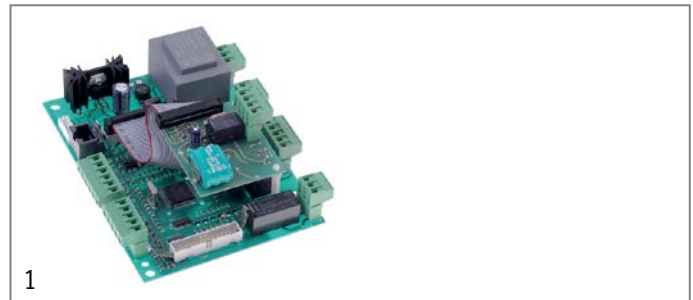

1

<b>Part No.</b>	401778	<b>Ref. No.</b>	28202 31412
<b>description</b>	power PCB		

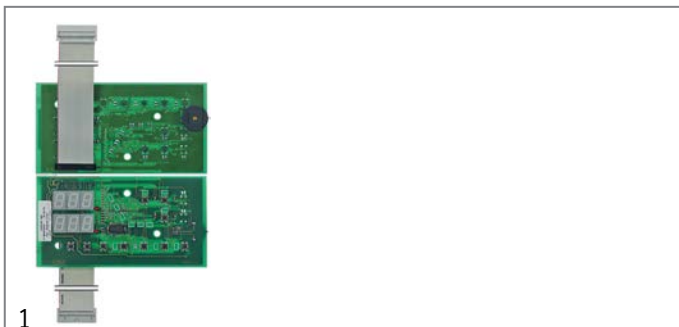

1

<b>Part No.</b>	403885	<b>Ref. No.</b>	31411
<b>description</b>	keypad PCB L 252mm W 112mm		

## keypads

### front foils



1

<b>Part No.</b>	694386	<b>Ref. No.</b>	32957 R_37221
<b>description</b>	front foil frame black L 227mm W 60mm		



1

<b>Part No.</b>	401782	<b>Ref. No.</b>	28706
-----------------	--------	-----------------	-------

<b>description</b>	keypad foil horizontal L 250mm W 110mm		
--------------------	--	--	--



1

<b>Part No.</b>	401781	<b>Ref. No.</b>	27776
-----------------	--------	-----------------	-------

<b>description</b>	keypad foil vertical L 138mm W 68mm		
--------------------	-------------------------------------	--	--

## solenoid valves

### solenoid valves (water)

#### RPE



1

<b>Part No.</b>	370123	<b>Ref. No.</b>	34130
-----------------	--------	-----------------	-------

<b>description</b>	solenoid valve single straight 230VAC inlet 1/2" outlet 1/2" DN10		
--------------------	---	--	--

#### solenoid valves with reducers

##### single



1

<b>Part No.</b>	374042	<b>Ref. No.</b>	34129
-----------------	--------	-----------------	-------

<b>description</b>	solenoid valve single straight 230VAC inlet 3/4" outlet 1/4" input 10-12l/min output 0.7-1l/min 10 RPE flow regulating valve outlet light green flow regulating valve inlet white		
--------------------	---	--	--

### solenoid valves (refrigeration)

#### CASTEL

##### valves



1

<b>Part No.</b>	370403	<b>Ref. No.</b>	18024
-----------------	--------	-----------------	-------

<b>description</b>	solenoid valve NC CASTEL 230V p max 45bar connection 10mm soldering connection -35 up to +105°C refrigeration		
--------------------	---	--	--

##### valve bodies

#### STANDARD series

suitable for refrigerants R22, R134a, R404A, R407C, R410A, R507





1

<b>Part No.</b>	370151	<b>Ref. No.</b>	00713
-----------------	--------	-----------------	-------

<b>description</b>	solenoid valve body NC type 1028/2 S p max 45bar connection 1/4" soldering connection DN 2.2mm -35 up to +105°C L 125mm refrigeration straight CASTEL		
--------------------	---	--	--

<b>accessories for</b>	370151		
------------------------	--------	--	--

	<b>Part No.</b>	371084	<b>Ref. No.</b>	—
	<b>description</b>	solenoid coil CASTEL 230VAC 8VA 50/60Hz connection cable 1000mm type CM2		

	<b>Part No.</b>	371090	<b>Ref. No.</b>	—
	<b>description</b>	power socket plug type DIN 43650A screw		

	<b>Part No.</b>	371301	<b>Ref. No.</b>	—
	<b>description</b>	solenoid coil CASTEL 110VAC 8VA 50/60Hz seat ø 11.5mm connection DIN 43650A type HF2		

	<b>Part No.</b>	371314	<b>Ref. No.</b>	—
	<b>description</b>	solenoid coil CASTEL 240VAC 8VA 50/60Hz seat ø 11.5mm		

	<b>Part No.</b>	371321	<b>Ref. No.</b>	—
	<b>description</b>	solenoid coil CASTEL 12/24VAC 50/60Hz seat ø 11.5mm connection DIN 43650A type HF2		





spare parts and accessories



1

<b>Part No.</b>	371041	<b>Ref. No.</b>	32348
-----------------	--------	-----------------	-------

**description** solenoid coil CASTEL 240VAC 8VA 50/60Hz seat ø 11.5mm connection DIN 43650A type HM2

**accessories for** 371041



<b>Part No.</b>	371090	<b>Ref. No.</b>	—
-----------------	--------	-----------------	---

power socket plug type DIN 43650A screw



<b>Part No.</b>	371092	<b>Ref. No.</b>	—
-----------------	--------	-----------------	---

power socket plug type DIN large cable length 1000mm

compressors

ACC/ZEL

R134A

HMBP monophase

High/Medium evaporation temperature above -20/-15 °C



1

<b>Part No.</b>	605007	<b>Ref. No.</b>	26056
-----------------	--------	-----------------	-------

**description** compressor coolant R134a type GL60TB 220-240V 50Hz HMBP fully hermetic 9.5kg 1/5HP power input 437W cylinder capacity 5.7cm<sup>3</sup> CSR H 175.5mm 95W 128W 170W 222W 284W 355W 437W 528W test method ASHRAE ambient temperature max. 43°C

R404a/R507

LBP monophase

Lower evaporation temperature below -20°C



1

<b>Part No.</b>	605127	<b>Ref. No.</b>	32712
-----------------	--------	-----------------	-------

**description** compressor coolant R404a/R507 type MX18FB 220-240V 50Hz LBP 17.3kg 5/8HP cylinder capacity 18.4cm<sup>3</sup> CSR H 230mm 575W 750W 985W 1219W 1498W test method ASHRAE ambient temperature max. 43°C

HMBP monophase

High/Medium evaporation temperature above -20/-15 °C



1

<b>Part No.</b>	605014	<b>Ref. No.</b>	30014
-----------------	--------	-----------------	-------

**description** compressor coolant R404a/R507 type ML80TB 220-240V 50Hz HMBP fully hermetic 11.4kg 3/8HP cylinder capacity 7.57cm<sup>3</sup> CSR H 175.5mmW 261W 346W 446W 561W 691W 835W 993W 1167W test method ASHRAE ambient temperature max. 43°C

CUBIGEL

R404a/R507

LBP monophase

Lower evaporation temperature below -20°C



1

<b>Part No.</b>	605180	<b>Ref. No.</b>	32714
-----------------	--------	-----------------	-------

**description** compressor coolant R404a/R507 type MX23FB 220-240V 50Hz LBP 17.5kg 1HP power input 7/8W cylinder capacity 23.2cm<sup>3</sup> CSR H 221mm 749W 982W 1246W 1541W 1868W test method ASHRAE ambient temperature max. 43°C





## HMBP monophasé

High/Medium evaporation temperature above -20/-15 °C



1

<b>Part No.</b>	605013	<b>Ref. No.</b>	28931
<b>description</b>	compressor coolant R404a/R507 type ML60TB 220-240V 50Hz HMBP fully hermetic 10.1kg 1/4HP power input 647W cylinder capacity 5.68cm <sup>3</sup> CSIR H 175.5mmW 244W 319W 407W 511W 628W 760W 906W 1067W test method ASHRAE		

## EMBRACO / ASPERA

## R404a/R507

## LBP monophasé

Lower evaporation temperature below -20°C



1

<b>Part No.</b>	605078	<b>Ref. No.</b>	27403
<b>description</b>	compressor coolant R404a/R507 type NT2180GK 220-240V 50Hz LBP fully hermetic 17.3kg 1HP cylinder capacity 20.44cm <sup>3</sup> CSIR H 221mm 515W 598W 682W 769W 859W 956W test method ASHRAE		

## fans

## refrigeration fans

## refrigeration motors universal

## ebm-papst

## multi fit fan motors



1

<b>Part No.</b>	601758	<b>Ref. No.</b>	28674
<b>description</b>	fan motor 16W 230V 50/60Hz L1 43.5mm L3 87mm W 72mm cable length 1500mm 1300/1550rpm ebm-papst M4Q045-CF01-75 5 mounting options bearing slide bearing		
<b>spare parts for</b>	601758		
	<b>Part No.</b>	601413	<b>Ref. No.</b> —
	fixing plate suitable for fanwheel ED ø 32mm shaft ø 7 mounting distance 26mm		

## cold air circulating fans (complete)

## ebm-papst

## A2E series

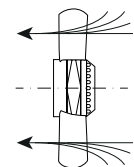
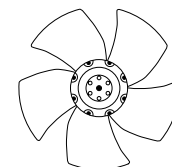



1

<b>Part No.</b>	601750	<b>Ref. No.</b>	27574 31316
<b>description</b>	fan A2E250-AL06-09 fan wheel ø 250mm blades 7 230V 50/60Hz 120/160W 2500rpm cable length 200mm ebm-papst sucking suitable capacitor 3µF		
<b>accessories for</b>	601750		
	<b>Part No.</b>	365137	<b>Ref. No.</b> —
	capacitor capacity 3µF 450V tolerance 5% 50/60Hz ambient temperature max. -25 to +85°C ø 25mm L 56mm M8 plastic connection cable 250mm 416.17.77GF protection		

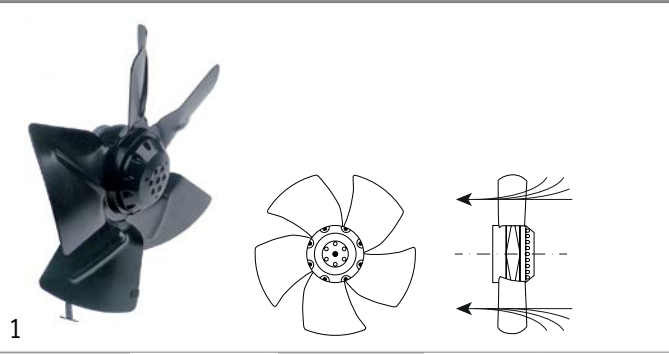

A4E series



<b>Part No.</b>	601623	<b>Ref. No.</b>	30221 30311 31311
<b>description</b>	fan A4E315-AC08-19 fan wheel ø 315mm blades 5 230V 50Hz 95W 1370rpm cable length 450mm ebm-papst sucking suitable capacitor 3µF		
<b>accessories for</b>	601623		
	<b>Part No.</b>	365137	<b>Ref. No.</b> —
	capacitor capacity 3µF 450V tolerance 5% 50/60Hz ambient temperature max. -25 to +85°C ø 25mm L 56mm M8 plastic connection cable 250mm 416.17.77GF protection		

R2E series

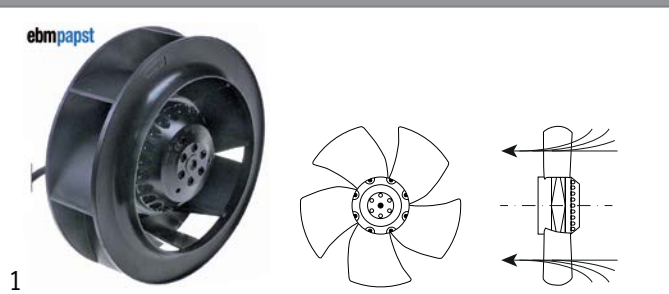

<b>Part No.</b>	601617	<b>Ref. No.</b>	00543 30631
<b>description</b>	fan R2E190-A026-66 fan wheel ø 190mm blades 6 230V 50Hz 58W ø 190mm H 70mm hole ø 8mm 2500rpm cable length 450mm rotation direction right ebm-papst sucking suitable capacitor 2µF		

hot air fans

miscellaneous

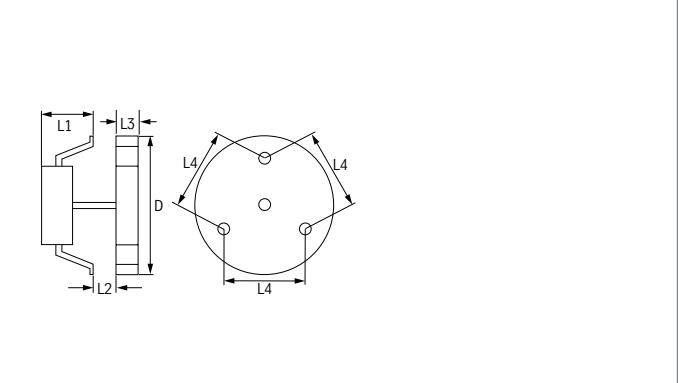

<b>Part No.</b>	601125	<b>Ref. No.</b>	00755
<b>description</b>	hot air fan 220-240V 45W 50/60Hz L1 70mm L2 11mm L3 25mm L4 87mm fan wheel ø 150mm FIME type C30R0479CLF		
<b>accessories for</b>	601125		
	<b>Part No.</b>	550879	<b>Ref. No.</b> —
	insulation ø 130mm thickness 3mm hole ø 20mm for hot air fan		

gas taps

PEL

21S series





<b>Part No.</b>	101397	<b>Ref. No.</b>	401101
<b>description</b>	gas tap PEL type 21S gas inlet M16x1.5 (tube ø 10mm) bypass nozzle ø 0.35mm gas outlet M16x1.5 (tube ø 10/8mm) thermocouple connection M9x1 pilot connection M10x1 shaft ø 8x6.5mm shaft L 22/15mm shaft flat lower		
<b>spare parts for</b>	101397		
	<b>Part No.</b>	100408	<b>Ref. No.</b> —
	bypass nozzle type PEL20/21 bore ø 0.35mm thread M5x0.5		
	<b>Part No.</b>	101060	<b>Ref. No.</b> —
	magnet unit standard L 39mm D1 ø 15.4mm D2 ø 11mm suitable for PEL20-21/JUNKERS/EGA		
	<b>Part No.</b>	101206	<b>Ref. No.</b> —
	gas tap front part shaft ø 8x6.5mm shaft L 22/15mm shaft flat upper/lower suitable for PEL21		

Table continues overleaf





<b>spare parts for</b>	101397		
	Part No.	101231	Ref. No. —
	thermocouple nut T1: M9x1 T2: M18x1		
<b>accessories for</b>	101397		
	Part No.	100908	Ref. No. —
	union screw thread M10x1 for pipe ø 4mm Qty 1 pcs		
	Part No.	100909	Ref. No. ID0103
	union screw thread M10x1 for pipe ø 6mm Qty 1 pcs		
	Part No.	101246	Ref. No. —
	olive for pipe ø 4mm Qty 1 pcs		
	Part No.	101278	Ref. No. —
	olive for pipe ø 10mm Qty 1 pcs		
	Part No.	101286	Ref. No. —
	olive ID ø 6mm Qty 1 pcs		
	Part No.	101300	Ref. No. —
	union nut thread M16x1.5 tube ø 10mm		
	Part No.	101450	Ref. No. —
	olive for pipe ø 8mm L 12.7mm Qty 1 pcs ED ø 10mm		
	Part No.	101451	Ref. No. —
	union nut thread M16x1.5 tube ø 8mm		
	Part No.	110081	Ref. No. —
	knob ø 70mm shaft ø 8x6.5mm shaft flat universal		
	Part No.	112206	Ref. No. —
	knob dial plate silver gas tap PEL21/22/23 t.max. °C ED ø 63mm ID ø 45.5mm		



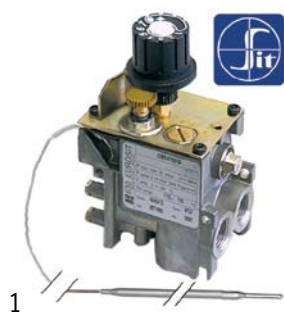

## gas thermostats







## SIT

## 630 Eurosit series



<b>Part No.</b>	101188	<b>Ref. No.</b>	60142 R_60142
<b>description</b>	gas thermostat type 630 Eurosit series t.max. 190°C 110-190°C gas inlet 3/8" gas outlet 3/8" thermocouple connection M9x1 pilot connection M10x1 probe ø 4mm probe L 202mm capillary pipe 1050mm SIT		
<b>accessories for</b>	101188		
	Part No.	100904	Ref. No. —
	locking screw M10x1 for pipe ø 4mm Qty 1 pcs		

<b>accessories for</b>	101188		
	Part No.	100905	Ref. No. ID0097
	locking screw M10x1 for pipe ø 6mm Qty 1 pcs		
	Part No.	101273	Ref. No. —
	olive for pipe ø 12mm L 9.5mm brass Qty 1 pcs suitable for universal		
	Part No.	101276	Ref. No. —
	union screw thread 3/8" tube ø 12mm Qty 1 pcs		
	Part No.	101333	Ref. No. 61066
	plug thread 3/8" with O-ring		

	1		
<b>Part No.</b>	101992	<b>Ref. No.</b>	821161
<b>description</b>	gas thermostat type 630 Eurosit series t.max. 190°C 110-190°C gas inlet 3/8" gas outlet 3/8" thermocouple connection M9x1 pilot connection M10x1 probe ø 4mm probe L 202mm capillary pipe 1050mm SIT		
<b>accessories for</b>	101992		
	Part No.	100904	Ref. No. —
	locking screw M10x1 for pipe ø 4mm Qty 1 pcs		
	Part No.	100905	Ref. No. ID0097
	locking screw M10x1 for pipe ø 6mm Qty 1 pcs		
	Part No.	101273	Ref. No. —
	olive for pipe ø 12mm L 9.5mm brass Qty 1 pcs suitable for universal		
	Part No.	101276	Ref. No. —
	union screw thread 3/8" tube ø 12mm Qty 1 pcs		
	Part No.	101333	Ref. No. 61066
	plug thread 3/8" with O-ring		
	Part No.	510655	Ref. No. —
	gasket silicone ø 7.8mm L 5mm blue Shore 55° Qty 10 pcs		







	1		
<b>Part No.</b>	101696	<b>Ref. No.</b>	60249
<b>description</b>	gas thermostat type 630 Eurosit series t.max. 300°C 60-300°C gas inlet 3/8" gas outlet 3/8" thermocouple connection M9x1 pilot connection M10x1 probe ø 4mm probe L 72mm capillary pipe 1050mm SIT		
<b>spare parts for</b>	101696		
	Part No.	101333	Ref. No. 61066
	plug thread 3/8" with O-ring		

Table continues overleaf



<b>accessories for</b>	101696			
	Part No.	100904	Ref. No.	—
	locking screw M10x1 for pipe ø 4mm Qty 1 pcs			
	Part No.	100905	Ref. No.	ID0097
	locking screw M10x1 for pipe ø 6mm Qty 1 pcs			
	Part No.	101273	Ref. No.	—
	olive for pipe ø 12mm L 9.5mm brass Qty 1 pcs suitable for universal			
	Part No.	101276	Ref. No.	—
	union screw thread 3/8" tube ø 12mm Qty 1 pcs			



<b>Part No.</b>	101915	<b>Ref. No.</b>	64357	
<b>description</b>	gas thermostat type 630 Eurosit series t.max. 320°C 80-320°C gas inlet 3/8" gas outlet 3/8" thermocouple connection M9x1 pilot connection M10x1 probe ø 4mm probe L 72mm capillary pipe 1050mm SIT			
<b>accessories for</b>	101915			
	Part No.	100825	Ref. No.	—
	gas tap spindle shaft ø 8x6.5mm shaft L 22/14mm suitable for EUROSIT			
	Part No.	100904	Ref. No.	—
	locking screw M10x1 for pipe ø 4mm Qty 1 pcs			
	Part No.	100905	Ref. No.	ID0097
	locking screw M10x1 for pipe ø 6mm Qty 1 pcs			
	Part No.	100949	Ref. No.	—
	gasket suitable for 630 Eurosit series			
	Part No.	101273	Ref. No.	—
	olive for pipe ø 12mm L 9.5mm brass Qty 1 pcs suitable for universal			
	Part No.	101276	Ref. No.	—
	union screw thread 3/8" tube ø 12mm Qty 1 pcs			
	Part No.	101333	Ref. No.	61066
	plug thread 3/8" with O-ring			
	Part No.	101390	Ref. No.	—
	gas tap spindle shaft ø 8x6.5mm shaft L 22/14mm suitable for EUROSIT			
	Part No.	101392	Ref. No.	—
	adapter suitable for 630 Eurosit series			
	Part No.	110357	Ref. No.	—
	gas tap spindle shaft ø 8x6.5mm shaft L 36/12mm suitable for 630 Eurosit series			
	Part No.	110358	Ref. No.	—
	adapter shaft ø 10x8mm shaft L 29/18mm suitable for 630 Eurosit series			

PEL

24ST series



<b>Part No.</b>	101076	<b>Ref. No.</b>	401201	
<b>description</b>	gas thermostat PEL type 24ST 120-320°C gas inlet M20x1.5 (tube ø 12mm) bypass nozzle ø 0.35mm gas outlet M20x1.5 (tube ø 12/10mm) thermocouple connection M9x1 pilot connection M10x1 capillary pipe 1200mm probe ø 6mm probe L 100mm shaft ø 10x8mm shaft L 27/17mm shaft flat upper			
<b>spare parts for</b>	101076			
	Part No.	100455	Ref. No.	—
	bypass nozzle type PEL23/24 bore ø 0.35mm thread M8x0.5			
	Part No.	101058	Ref. No.	—
	magnet unit L 39mm D1 ø 15.4mm D2 ø 13.5mm suitable for PEL22/EGA24197 standard			
	Part No.	106200	Ref. No.	—
	nut thread M9x1 suitable for PEL 24/25S			
<b>accessories for</b>	101076			
	Part No.	100908	Ref. No.	—
	union screw thread M10x1 for pipe ø 4mm Qty 1 pcs			
	Part No.	100909	Ref. No.	ID0103
	union screw thread M10x1 for pipe ø 6mm Qty 1 pcs			
	Part No.	101246	Ref. No.	—
	olive for pipe ø 4mm Qty 1 pcs			
	Part No.	101248	Ref. No.	—
	olive for pipe ø 12mm Qty 1 pcs suitable for PEL			
	Part No.	101249	Ref. No.	—
	olive for pipe ø 10mm Qty 1 pcs			
	Part No.	101250	Ref. No.	—
	union nut thread M20x1.5 for pipe ø 10mm			
	Part No.	101251	Ref. No.	—
	union nut thread M20x1.5 for pipe ø 12mm			
	Part No.	101286	Ref. No.	—
	olive ID ø 6mm Qty 1 pcs			
	Part No.	110079	Ref. No.	—
	knob dial plate gas thermostat 1-8 silver			
	Part No.	110080	Ref. No.	—
	knob ø 70mm shaft ø 10x8mm shaft flat universal			



## gas valves and ignition boxes









## gas control valves

SIT

NOVASIT



1

<b>Part No.</b>	101956	<b>Ref. No.</b>	60309 921161
<b>description</b>	gas valve SIT series Novasit 820 230V 50Hz gas inlet 1/2" gas outlet 1/2" thermocouple connection M9x1 pilot connection M10x1 ignition pressure range 5-50mbar pressure regulator connection blind equiv. no. 0.820.031		
<b>spare parts for</b>	101956		
	<b>Part No.</b>	101065	<b>Ref. No.</b> —
	magnet unit with cable L 44mm D1 ø 30mm D2 ø 20mm suitable for NOVASIT		
	<b>Part No.</b>	101313	<b>Ref. No.</b> —
	solenoid coil 230V 50Hz		
<b>accessories for</b>	101956		
	<b>Part No.</b>	100006	<b>Ref. No.</b> —
	piezoelectric igniter suitable for ELETTRISIT body plastic blowing connection ø2.4mm ø 14mm		
	<b>Part No.</b>	101305	<b>Ref. No.</b> —
	gas connection straight 1/2" flange 45x45mm ELETTRISIT/V4400/4600/4605 suitable for SIT/HONEYWELL hole distance 36x36mm		
	<b>Part No.</b>	101306	<b>Ref. No.</b> —
	gas connection angled flange 45x45mm hole distance 36x36mm 1/2" ELETTRISIT/V4400/4600/4605 screw with O-ring suitable for SIT/HONEYWELL		
	<b>Part No.</b>	101307	<b>Ref. No.</b> —
	gas connection straight flange 45x45mm hole distance 36x36mm 3/4" ELETTRISIT/V4400/4600/4605 screw with O-ring suitable for SIT/HONEYWELL		
	<b>Part No.</b>	101308	<b>Ref. No.</b> —
	gas connection angled flange 45x45mm hole distance 36x36mm 3/4" ELETTRISIT/V4400/4600/4605 screw with O-ring suitable for SIT/HONEYWELL		
	<b>Part No.</b>	101312	<b>Ref. No.</b> —
	microswitch		
	<b>Part No.</b>	101314	<b>Ref. No.</b> —
	solenoid coil 24V 50Hz		
	<b>Part No.</b>	101317	<b>Ref. No.</b> —
	plug with cable L 1000mm suitable for NOVASIT		
	<b>Part No.</b>	101318	<b>Ref. No.</b> —
	cover cap for solenoid coil suitable for NOVASIT		

## accessories



1

<b>Part No.</b>	100905	<b>Ref. No.</b>	ID0097
<b>description</b>	locking screw M10x1 for pipe ø 6mm Qty 1 pcs		

## ignition parts





## pilot burners

SIT

100 series



1

<b>Part No.</b>	107140	<b>Ref. No.</b>	61603
<b>description</b>	pilot burner SIT type 100 series 3 flames nozzle ø 20mm gas connectionmm		
<b>spare parts for</b>	107140		
	<b>Part No.</b>	100855	<b>Ref. No.</b> —
	pilot burner bracket triple		
	<b>Part No.</b>	100885	<b>Ref. No.</b> —
	air mixing sleeve for pilot burner Qty 1 pcs		
	<b>Part No.</b>	100916	<b>Ref. No.</b> —
	compression spring for pilot burner Qty 1 pcs		
	<b>Part No.</b>	107162	<b>Ref. No.</b> —
	pilot burner cap SIT 3 flames Hmm Lmm Qty 1 pcs		
<b>accessories for</b>	107140		
	<b>Part No.</b>	100904	<b>Ref. No.</b> —
	locking screw M10x1 for pipe ø 4mm Qty 1 pcs		
	<b>Part No.</b>	100905	<b>Ref. No.</b> ID0097
	locking screw M10x1 for pipe ø 6mm Qty 1 pcs		





accessories			
ignition electrodes			
<b>Part No.</b>	100706	<b>Ref. No.</b>	61602
<b>description</b>	ignition electrode connection M4 Qty 1 pcs		















140 - 145 -150 series			
<b>Part No.</b>	107134	<b>Ref. No.</b>	60354
<b>description</b>	pilot burner SIT type 140 series 1 flame nozzle $\varnothing$ mm gas connectionmm		
<b>accessories for</b>	107134		
	<b>Part No.</b>	100204	<b>Ref. No.</b> —
	pilot burner nozzle SIT LPG code 14 bore $\varnothing$ 0.18/0.20mm Qty 1 pcs suitable for 140 series		
	<b>Part No.</b>	100205	<b>Ref. No.</b> —
	pilot burner nozzle SIT LPG code 19 bore $\varnothing$ 0.23/0.26mm Qty 1 pcs suitable for SIT 150 series		
	<b>Part No.</b>	100206	<b>Ref. No.</b> 111006 61070
	pilot burner nozzle SIT natural gas code 36 bore $\varnothing$ 0.60/0.55mm Qty 1 pcs suitable for SIT 150 series		
	<b>Part No.</b>	100207	<b>Ref. No.</b> 111008 61243
	pilot burner nozzle SIT natural gas code 27 bore $\varnothing$ 0.40/0.38mm suitable for SIT 140 series		
	<b>Part No.</b>	100216	<b>Ref. No.</b> —
	pilot burner nozzle SIT natural gas code 38 bore $\varnothing$ 0.45mm Qty 1 pcs suitable for SIT 150 series		
	<b>Part No.</b>	100701	<b>Ref. No.</b> 61067
	ignition electrode connection M4 Qty 1 pcs		
	<b>Part No.</b>	100897	<b>Ref. No.</b> —
	olive for pipe $\varnothing$ 4mm Qty 1 pcs for pilot burner		
	<b>Part No.</b>	100898	<b>Ref. No.</b> 111007
	olive for pipe $\varnothing$ 6mm Qty 1 pcs for pilot burner		
	<b>Part No.</b>	100906	<b>Ref. No.</b> 110163
	screw connection thread M10x1 for ignition electrode brass Qty 1 pcs WS 10		
	<b>Part No.</b>	100907	<b>Ref. No.</b> —
	screw connection thread M10x1 Qty 1 pcs type SEF 1 $\varnothing$ mm for thermocouple		
	<b>Part No.</b>	100908	<b>Ref. No.</b> —
	union screw thread M10x1 for pipe $\varnothing$ 4mm Qty 1 pcs		

<b>accessories for</b>	107134		
	<b>Part No.</b>	100909	<b>Ref. No.</b> ID0103
	union screw thread M10x1 for pipe $\varnothing$ 6mm Qty 1 pcs		



<b>Part No.</b>	107132	<b>Ref. No.</b>	111003
<b>description</b>	pilot burner SIT type 140 series 2 flames nozzle $\varnothing$ mm gas connectionmm		
<b>accessories for</b>	107132		
	<b>Part No.</b>	100204	<b>Ref. No.</b> —
	pilot burner nozzle SIT LPG code 14 bore $\varnothing$ 0.18/0.20mm Qty 1 pcs suitable for 140 series		
	<b>Part No.</b>	100205	<b>Ref. No.</b> —
	pilot burner nozzle SIT LPG code 19 bore $\varnothing$ 0.23/0.26mm Qty 1 pcs suitable for SIT 150 series		
	<b>Part No.</b>	100206	<b>Ref. No.</b> 111006 61070
	pilot burner nozzle SIT natural gas code 36 bore $\varnothing$ 0.60/0.55mm Qty 1 pcs suitable for SIT 150 series		
	<b>Part No.</b>	100207	<b>Ref. No.</b> 111008 61243
	pilot burner nozzle SIT natural gas code 27 bore $\varnothing$ 0.40/0.38mm suitable for SIT 140 series		
	<b>Part No.</b>	100216	<b>Ref. No.</b> —
	pilot burner nozzle SIT natural gas code 38 bore $\varnothing$ 0.45mm Qty 1 pcs suitable for SIT 150 series		
	<b>Part No.</b>	100701	<b>Ref. No.</b> 61067
	ignition electrode connection M4 Qty 1 pcs		
	<b>Part No.</b>	100897	<b>Ref. No.</b> —
	olive for pipe $\varnothing$ 4mm Qty 1 pcs for pilot burner		
	<b>Part No.</b>	100898	<b>Ref. No.</b> 111007
	olive for pipe $\varnothing$ 6mm Qty 1 pcs for pilot burner		
	<b>Part No.</b>	100906	<b>Ref. No.</b> 110163
	screw connection thread M10x1 for ignition electrode brass Qty 1 pcs WS 10		
	<b>Part No.</b>	100907	<b>Ref. No.</b> —
	screw connection thread M10x1 Qty 1 pcs type SEF 1 $\varnothing$ mm for thermocouple		
	<b>Part No.</b>	100908	<b>Ref. No.</b> —
	union screw thread M10x1 for pipe $\varnothing$ 4mm Qty 1 pcs		
	<b>Part No.</b>	100909	<b>Ref. No.</b> ID0103
	union screw thread M10x1 for pipe $\varnothing$ 6mm Qty 1 pcs		
	<b>Part No.</b>	102110	<b>Ref. No.</b> —
	pilot tube copper pipe $\varnothing$ 4mm thickness 1mm L 3000mm		
	<b>Part No.</b>	102111	<b>Ref. No.</b> —
	pilot tube copper pipe $\varnothing$ 6mm thickness 1mm L 3000mm		





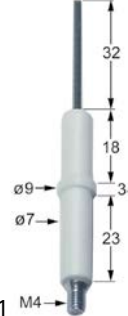

160 series			
			
<b>Part No.</b>	100056	<b>Ref. No.</b>	110159
<b>description</b>	pilot burner SIT type 160 series 3 flames nozzle ømm gas connectionmm		
<b>spare parts for</b>	100056		
	<b>Part No.</b>	100907	<b>Ref. No.</b> —
	screw connection thread M10x1 Qty 1 pcs type SEF 1 ømm for thermocouple		
<b>accessories for</b>	100056		
	<b>Part No.</b>	100202	<b>Ref. No.</b> —
	pilot burner nozzle natural gas code 41 Qty 1 pcs nozzle ø 0.41mm		
	<b>Part No.</b>	100203	<b>Ref. No.</b> —
	pilot burner nozzle LPG code 25 Qty 1 pcs nozzle ø 0.25mm		
	<b>Part No.</b>	100701	<b>Ref. No.</b> 61067
	ignition electrode connection M4 Qty 1 pcs		
	<b>Part No.</b>	100801	<b>Ref. No.</b> —
	gasket for pilot burner Qty 1 pcs		
	<b>Part No.</b>	100869	<b>Ref. No.</b> —
	pilot burner nozzle natural gas code 51 Qty 1 pcs suitable for 160 series nozzle ø 0.51mm		
	<b>Part No.</b>	100870	<b>Ref. No.</b> —
	olive for pipe ø 4mm Qty 1 pcs suitable for 160 series for pilot burner		
	<b>Part No.</b>	100906	<b>Ref. No.</b> 110163
	screw connection thread M10x1 for ignition electrode brass Qty 1 pcs WS 10		
	<b>Part No.</b>	100908	<b>Ref. No.</b> —
	union screw thread M10x1 for pipe ø 4mm Qty 1 pcs		
	<b>Part No.</b>	100909	<b>Ref. No.</b> ID0103
	union screw thread M10x1 for pipe ø 6mm Qty 1 pcs		
	<b>Part No.</b>	101287	<b>Ref. No.</b> —
	olive for pipe ø 6mm Qty 1 pcs		
	<b>Part No.</b>	102110	<b>Ref. No.</b> —
	pilot tube copper pipe ø 4mm thickness 1mm L 3000mm		
	<b>Part No.</b>	102111	<b>Ref. No.</b> —
	pilot tube copper pipe ø 6mm thickness 1mm L 3000mm		
	<b>Part No.</b>	107650	<b>Ref. No.</b> —
	pilot burner nozzle SIT LPG code 30 Qty 1 pcs		

electrodes

			
<b>Part No.</b>	100701	<b>Ref. No.</b>	61067
<b>description</b>	ignition electrode connection M4 Qty 1 pcs		
<b>accessories for</b>	100701		
	<b>Part No.</b>	100906	<b>Ref. No.</b> 110163
	screw connection thread M10x1 for ignition electrode brass Qty 1 pcs WS 10		

			
<b>Part No.</b>	100706	<b>Ref. No.</b>	61602
<b>description</b>	ignition electrode connection M4 Qty 1 pcs		

			
<b>Part No.</b>	100871	<b>Ref. No.</b>	61068
<b>description</b>	ignition electrode D1 ø 7mm connection M4 to clip		

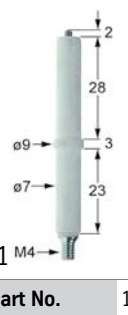
			
<b>Part No.</b>	102314	<b>Ref. No.</b>	6010061-GI
<b>description</b>	ignition electrode D1 ø 7mm D2 ø 9mm connection M4 L1 2mm BL1 28mm BL2 3mm BL3 23mm to clip		



<b>Part No.</b>	102330	<b>Ref. No.</b>	110262
<b>description</b>	ignition electrode D1 ø 7mm D2 ø 9mm L1 16mm BL1 18mm BL2 3mm BL3 23mm to clip connection ø 2.4mm		

<b>Part No.</b>	100906	<b>Ref. No.</b>	110163
<b>description</b>	screw connection thread M10x1 for ignition electrode brass Qty 1 pcs WS 10		

piezoelectric igniters

mounting diameter 18mm

<b>Part No.</b>	100009	<b>Ref. No.</b>	60829	
<b>description</b>	piezoelectric igniter body plastic blowing mounting ø 18mm connection ø2.4mm front measurements 26mm M18x1.5			
<b>accessories for</b>	100009			
	<b>Part No.</b>	101339	<b>Ref. No.</b>	—
	cover cap for piezoelectric igniter			
	<b>Part No.</b>	106869	<b>Ref. No.</b>	—
	cover cap for piezoelectric igniter ID ø 22mm ED ø 35mm H 25mm			
	<b>Part No.</b>	107931	<b>Ref. No.</b>	—
	cover cap for piezoelectric igniter ID ø 21mm ED ø 36mm			

thermocouples

plug-in thermocouples

plug-in thermocouples standard

with barrel socket ø6(6.5)mm

thermocouples SIT

<b>Part No.</b>	107614	<b>Ref. No.</b>	61061
<b>description</b>	thermocouple SIT M9x1 L 1500mm plug connection ø6.0(6.5)mm		

<b>Part No.</b>	107606	<b>Ref. No.</b>	837233
<b>description</b>	thermocouple SIT M9x1 L 320mm plug connection ø6.0(6.5)mm		

<b>Part No.</b>	107610	<b>Ref. No.</b>	61060
<b>description</b>	thermocouple SIT M9x1 L 750mm plug connection ø6.0(6.5)mm		

<b>Part No.</b>	107611	<b>Ref. No.</b>	6010057-GI
<b>description</b>	thermocouple SIT M9x1 L 850mm plug connection ø6.0(6.5)mm		



plug-in thermocouples with aluminised tip

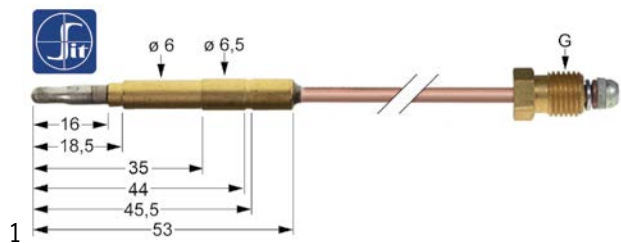

<b>Part No.</b>	102681	<b>Ref. No.</b>	R_61074
<b>description</b>	thermocouple fast closing M9x1 L 850mm plug connection ø6.5mm		

accessories

screws



<b>Part No.</b>	102464	<b>Ref. No.</b>	110176
<b>description</b>	thermocouple fitting thread M10x1 brass Qty 1 pcs		

gas burners

hob burners

accessories

reducers for pan supports

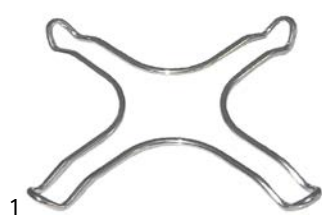

<b>Part No.</b>	210050	<b>Ref. No.</b>	61320
<b>description</b>	reducer for pan support L 260mm W 260mm chrome-plated steel suitable for universal		

spillage trays



<b>Part No.</b>	105465	<b>Ref. No.</b>	440081
<b>description</b>	drain tray L 380mm W 350mm for burner cap ø 110mm		



<b>Part No.</b>	105466	<b>Ref. No.</b>	440083
<b>description</b>	drain tray L 380mm W 350mm for burner cap ø 130mm		

gas nozzles

pilot burner nozzles

pilot burner nozzles SIT

140/150 series



<b>Part No.</b>	100207	<b>Ref. No.</b>	111008 61243
<b>description</b>	pilot burner nozzle SIT natural gas code 27 bore ø 0.40/0.38mm suitable for SIT 140 series		



<b>Part No.</b>	100206	<b>Ref. No.</b>	111006 61070
<b>description</b>	pilot burner nozzle SIT natural gas code 36 bore ø 0.60/0.55mm Qty 1 pcs suitable for SIT 150 series		

auxiliary gas parts

screw connections

olives



<b>Part No.</b>	100898	<b>Ref. No.</b>	111007
<b>description</b>	olive for pipe ø 6mm Qty 1 pcs for pilot burner		

<b>accessories for</b>	100898			
	<b>Part No.</b>	100909	<b>Ref. No.</b>	ID0103
	union screw thread M10x1 for pipe ø 6mm Qty 1 pcs			



union screws



1

<b>Part No.</b>	100905	<b>Ref. No.</b>	ID0097
<b>description</b>	locking screw M10x1 for pipe ø 6mm Qty 1 pcs		







1

<b>Part No.</b>	100906	<b>Ref. No.</b>	110163
<b>description</b>	screw connection thread M10x1 for ignition electrode brass Qty 1 pcs WS 10		



1

<b>Part No.</b>	100909	<b>Ref. No.</b>	ID0103	
<b>description</b>	union screw thread M10x1 for pipe ø 6mm Qty 1 pcs			
<b>accessories for</b>	100909			
	<b>Part No.</b>	100898	<b>Ref. No.</b>	111007
	olive for pipe ø 6mm Qty 1 pcs for pilot burner			
	<b>Part No.</b>	101286	<b>Ref. No.</b>	—
	olive ID ø 6mm Qty 1 pcs			
	<b>Part No.</b>	101287	<b>Ref. No.</b>	—
	olive for pipe ø 6mm Qty 1 pcs			
	<b>Part No.</b>	101288	<b>Ref. No.</b>	—
	olive for pipe ø 6mm L 6mm aluminium Qty 1 pcs ED ø 8.5mm			

equipment-specific units

for fridges

housing and bezels

miscellaneous



1

<b>Part No.</b>	694387	<b>Ref. No.</b>	32810
<b>description</b>	frame L 179mm W 44mm H 6.5mm		

knobs

producer-specific knobs

ILSA



1

<b>Part No.</b>	112508	<b>Ref. No.</b>	18633
<b>description</b>	knob switch zero mark ø 19mm shaft ø 6x4.6mm black		



1

<b>Part No.</b>	112666	<b>Ref. No.</b>	01434 31051
<b>description</b>	knob thermostat 30-90°C ø 48.5mm shaft ø 6x4.6mm shaft flat upper black		

handles and hand wheels

cone handles



1

<b>Part No.</b>	691395	<b>Ref. No.</b>	62510
<b>description</b>	cone handle thread M8 ø 24mm L 59mm black		



## locks

## edgemount latches

## handle latches

## producer-specific

## INOXTREND



1	<b>Part No.</b>	690536	<b>Ref. No.</b>	R_C8118-00-IN
	<b>description</b>	catch L 172mm mounting distance 133mm non lockable chrome-plated 6200 total length 248mm		
	<b>accessories for</b>	690536		
	<b>Part No.</b>	690123	<b>Ref. No.</b>	—
	door catch with roller			

## hinges

## spring assisted hinges

## producer-specific

## ILSA



1	<b>Part No.</b>	691964	<b>Ref. No.</b>	14842 30876
	<b>description</b>	spring assisted hinge L 170mm mounting pos. bottom left/upper right		
	<b>spare parts for</b>	691964		
	<b>Part No.</b>	692081	<b>Ref. No.</b>	00782
	torsion spring ø 16mm total length 123mm wire gauge ø 2mm L1 100mm mounting pos. left			



1	<b>Part No.</b>	692071	<b>Ref. No.</b>	14841 30875
	<b>description</b>	spring assisted hinge L 170mm mounting pos. bottom right/upper left		
	<b>spare parts for</b>	692071		
	<b>Part No.</b>	692082	<b>Ref. No.</b>	00781
	torsion spring ø 16mm total length 123mm wire gauge ø 2mm L1 100mm			

## door bearing



1	<b>Part No.</b>	694384	<b>Ref. No.</b>	32080
	<b>description</b>	hinge L 110mm W 66mm H 23mm mounting pos. bottom left with bolt		



1	<b>Part No.</b>	694385	<b>Ref. No.</b>	32888 R32888
	<b>description</b>	hinge L 110mm W 66mm H 24mm mounting pos. upper left with bolt		



1	<b>Part No.</b>	692078	<b>Ref. No.</b>	26403
	<b>description</b>	hinge mounting pos. bottom left		



1	<b>Part No.</b>	692076	<b>Ref. No.</b>	26402
	<b>description</b>	hinge mounting pos. bottom right		





1	<b>Part No.</b>	692577	<b>Ref. No.</b>	27348
	<b>description</b>	hinge camp L 110mm W 66mm mounting pos. left bottom thickness 3mm		





1	<b>Part No.</b>	692576	<b>Ref. No.</b>	19456 29132
	<b>description</b>	hinge camp L 110mm W 66mm mounting pos. right bottom thickness 3mm kit		





			
1			
<b>Part No.</b>	692072	<b>Ref. No.</b>	31282
<b>description</b>	hinge camp mounting pos. centre/right		

			
1			
<b>Part No.</b>	691965	<b>Ref. No.</b>	30874
<b>description</b>	hinge camp mounting pos. lower		

			
1			
<b>Part No.</b>	692074	<b>Ref. No.</b>	26401
<b>description</b>	hinge camp mounting pos. upper left		

			
1			
<b>Part No.</b>	692085	<b>Ref. No.</b>	30379
<b>description</b>	hinge camp mounting pos. upper left		

			
1			
<b>Part No.</b>	692073	<b>Ref. No.</b>	26400
<b>description</b>	hinge camp mounting pos. upper right		

			
1			
<b>Part No.</b>	692075	<b>Ref. No.</b>	30344
<b>description</b>	hinge camp mounting pos. upper right		

## shelves and shelf rails

### grates

#### universal

#### without upstand



1			
<b>Part No.</b>	970122	<b>Ref. No.</b>	GRI0012
<b>description</b>	grate W 325mm D 530mm GN 1/1 H 8mm stainless steel wire gauge frame 7mm lengthwise wires gauge 4mm crossing wires 1		
<b>accessories for</b>	970122		
	<b>Part No.</b>	690330	<b>Ref. No.</b>
	rack L 1000mm W 22mm H 4mm aperture 3x8mm hole distance 12.5mm stainless steel		
	<b>Part No.</b>	694700	<b>Ref. No.</b>
	shelf support L 31/28mm W 22mm H 18mm SS Qty 12 pcs		
	<b>Part No.</b>	694701	<b>Ref. No.</b>
	shelf support L 31/28mm W 22mm H 17mm SS with hook Qty 12 pcs		





#### with upstand



1			
<b>Part No.</b>	970527	<b>Ref. No.</b>	20370
<b>description</b>	grate W 530mm D 650mm GN 2/1 chrome-plated steel with hinge camp crossing wires 2 suitable for refrigerator		
<b>accessories for</b>	970527		
	<b>Part No.</b>	690330	<b>Ref. No.</b>
	rack L 1000mm W 22mm H 4mm aperture 3x8mm hole distance 12.5mm stainless steel		
	<b>Part No.</b>	694700	<b>Ref. No.</b>
	shelf support L 31/28mm W 22mm H 18mm SS Qty 12 pcs		
	<b>Part No.</b>	694701	<b>Ref. No.</b>
	shelf support L 31/28mm W 22mm H 17mm SS with hook Qty 12 pcs		







			
1			
<b>Part No.</b>	970556	<b>Ref. No.</b>	GRI0011
<b>description</b>	grate W 530mm D 650mm GN 2/1 plastic-coated steel with hinge camp wire gauge frame 9mm lengthwise wires gauge 5mm crossing wires 2 white suitable for refrigerator		
<b>accessories for</b>	970556		
	<b>Part No.</b>	690330	<b>Ref. No.</b> —
	rack L 1000mm W 22mm H 4mm aperture 3x8mm hole distance 12.5mm stainless steel		
	<b>Part No.</b>	690332	<b>Ref. No.</b> —
	shelf support L 31/28mm W 22mm H 17mm SS with hook Qty 1 pcs		
	<b>Part No.</b>	694700	<b>Ref. No.</b> —
	shelf support L 31/28mm W 22mm H 18mm SS Qty 12 pcs		
	<b>Part No.</b>	694701	<b>Ref. No.</b> —
	shelf support L 31/28mm W 22mm H 17mm SS with hook Qty 12 pcs		

## shelf rails and supports

## producer-specific

			
1			
<b>Part No.</b>	692084	<b>Ref. No.</b>	26412
<b>description</b>	guide U-shape L 660mm W 27mm inner height 25mm mounting pos. left		

			
1			
<b>Part No.</b>	692083	<b>Ref. No.</b>	26413
<b>description</b>	guide U-shape L 660mm W 27mm inner height 25mm mounting pos. right		

## gaskets

## refrigeration gaskets

## plug-in gaskets

## profile 9792

			
1			
<b>Part No.</b>	902439	<b>Ref. No.</b>	36475
<b>description</b>	refrigeration gasket profile 9792 W 172mm L 387mm plug size		

## profile 9048

We offer custom-made gaskets for this profile

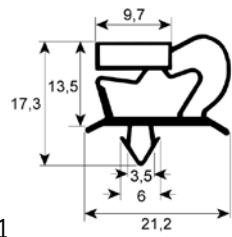
			
1			
<b>Part No.</b>	900925	<b>Ref. No.</b>	19827
<b>description</b>	refrigeration gasket profile 9048 W 170mm L 385mm plug size		

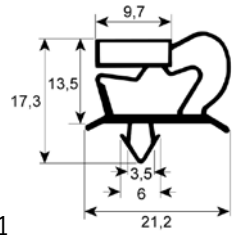
			
1			
<b>Part No.</b>	900924	<b>Ref. No.</b>	19102 36473
<b>description</b>	refrigeration gasket profile 9048 W 210mm L 385mm plug size		

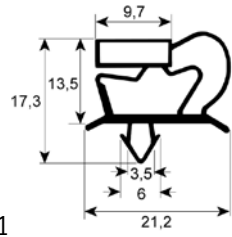
			
1			
<b>Part No.</b>	901047	<b>Ref. No.</b>	19100
<b>description</b>	refrigeration gasket profile 9048 W 282mm L 390mm plug size		

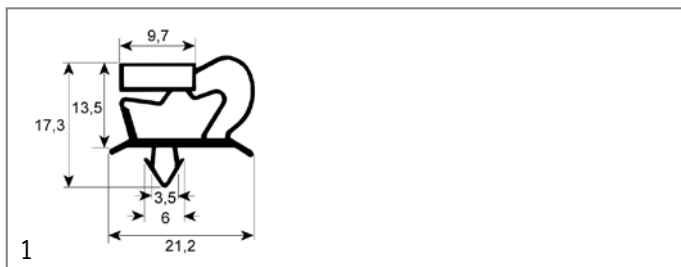

<b>Part No.</b>	901477	<b>Ref. No.</b>	34574
<b>description</b>	refrigeration gasket profile 9048 W 365mm L 705mm plug size		

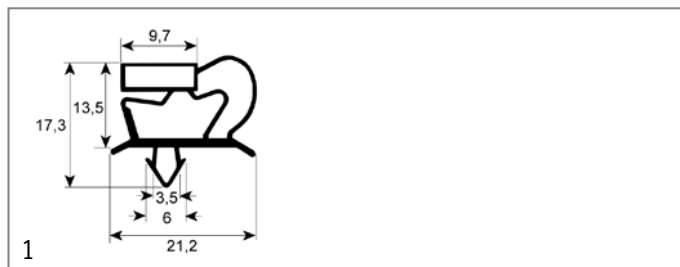

<b>Part No.</b>	901046	<b>Ref. No.</b>	19259
<b>description</b>	refrigeration gasket profile 9048 W 386mm L 389mm plug size		

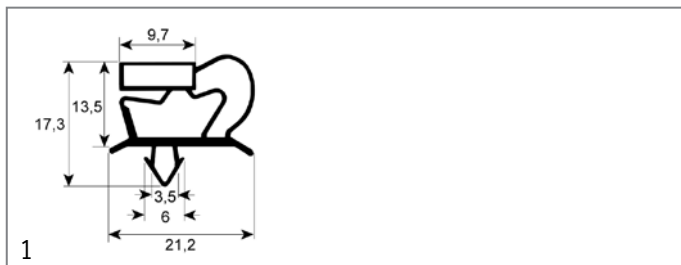

<b>Part No.</b>	901463	<b>Ref. No.</b>	00779
<b>description</b>	refrigeration gasket profile 9048 W 375mm L 175mm plug size		

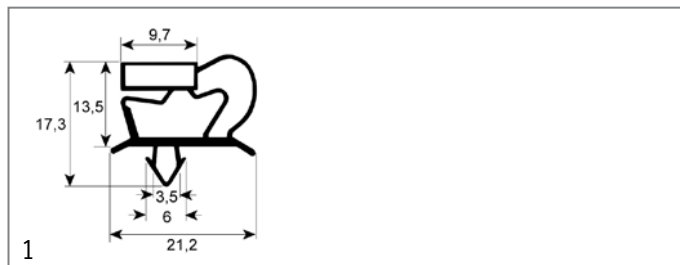

<b>Part No.</b>	900926	<b>Ref. No.</b>	19099
<b>description</b>	refrigeration gasket profile 9048 W 388mm L 610mm plug size		

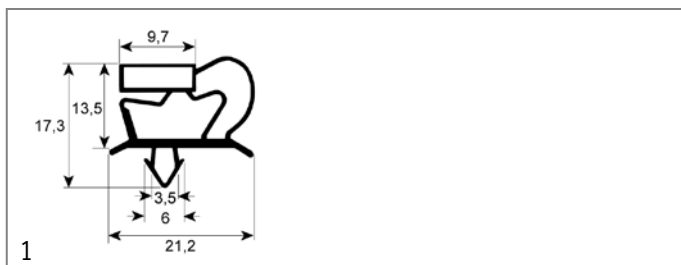

<b>Part No.</b>	901464	<b>Ref. No.</b>	00778
<b>description</b>	refrigeration gasket profile 9048 W 375mm L 275mm plug size		

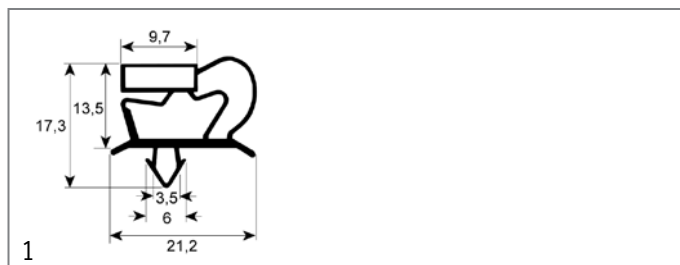

<b>Part No.</b>	901048	<b>Ref. No.</b>	30485
<b>description</b>	refrigeration gasket profile 9048 W 400mm L 500mm plug size		

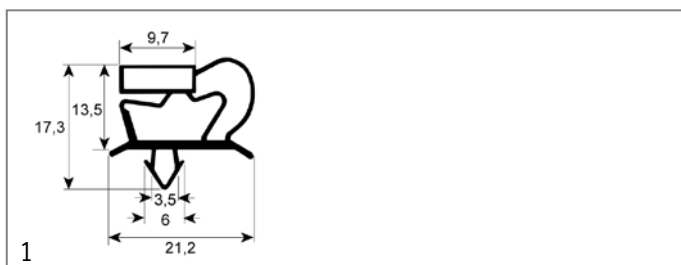

<b>Part No.</b>	901465	<b>Ref. No.</b>	00780
<b>description</b>	refrigeration gasket profile 9048 W 375mm L 390mm plug size		

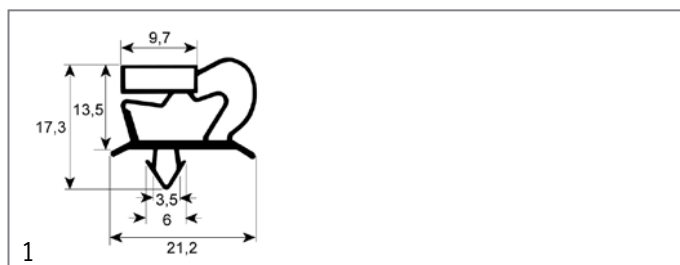

<b>Part No.</b>	901222	<b>Ref. No.</b>	29715
<b>description</b>	refrigeration gasket profile 9048 W 415mm L 709mm plug size for blast chiller		

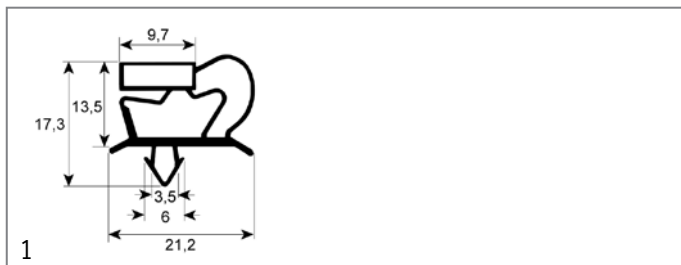

<b>Part No.</b>	900929	<b>Ref. No.</b>	00777
<b>description</b>	refrigeration gasket profile 9048 W 375mm L 610mm plug size		

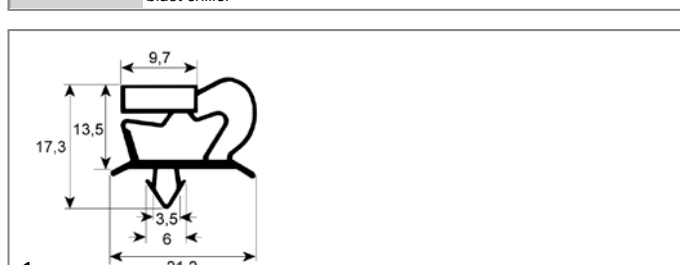

<b>Part No.</b>	900928	<b>Ref. No.</b>	00776
<b>description</b>	refrigeration gasket profile 9048 W 456mm L 621mm plug size		



<b>Part No.</b>	901045	<b>Ref. No.</b>	19098
<b>description</b>	refrigeration gasket profile 9048 W 465mm L 615mm plug size		

<b>Part No.</b>	901221	<b>Ref. No.</b>	27375
<b>description</b>	refrigeration gasket profile 9048 W 612mm L 725mm plug size for blast chiller		

<b>Part No.</b>	901044	<b>Ref. No.</b>	18567
<b>description</b>	refrigeration gasket profile 9048 W 640mm L 725mm plug size		

<b>Part No.</b>	900927	<b>Ref. No.</b>	18565
<b>description</b>	refrigeration gasket profile 9048 W 645mm L 1535mm plug size		

<b>Part No.</b>	901219	<b>Ref. No.</b>	27573
<b>description</b>	refrigeration gasket profile 9048 W 721mm L 1154mm plug size blast chiller		

<b>Part No.</b>	901220	<b>Ref. No.</b>	27572
<b>description</b>	refrigeration gasket profile 9048 W 721mm L 929mm plug size for blast chiller		

## profile 9773

We offer custom-made gaskets for this profile

<b>Part No.</b>	902443	<b>Ref. No.</b>	R_34516
<b>description</b>	refrigeration gasket profile 9773 W 640mm L 1475mm plug size		

<b>Part No.</b>	901472	<b>Ref. No.</b>	33993 34517
<b>description</b>	refrigeration gasket profile 9773 W 655mm L 700mm external size W1 642mm L1 687mm plug size		

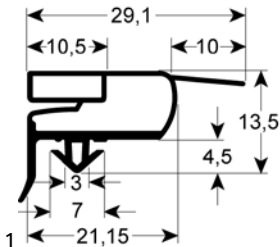

			
<b>Part No.</b>	901136	<b>Ref. No.</b>	33992 34516
<b>description</b>	refrigeration gasket profile 9773 W 658mm L 1498mm external size W1 645mm L1 1485mm plug size		

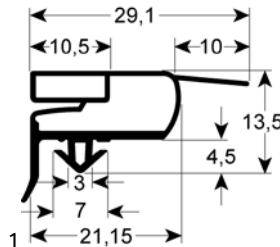
			
<b>Part No.</b>	901471	<b>Ref. No.</b>	33842
<b>description</b>	refrigeration gasket profile 9773 W 675mm L 1490mm external size W1 662mm L1 1477mm plug size		

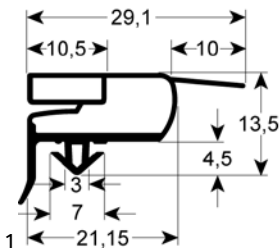
			
<b>Part No.</b>	901039	<b>Ref. No.</b>	30799 33696
<b>description</b>	refrigeration gasket profile 9773 W 658mm L 723mm external size W1 645mm L1 710mm plug size		

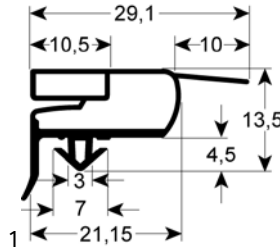
			
<b>Part No.</b>	901040	<b>Ref. No.</b>	31262 33697 R_33697
<b>description</b>	refrigeration gasket profile 9773 W 698mm L 1538mm external size W1 685mm L1 1525mm plug size		

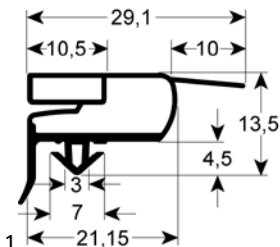
			
<b>Part No.</b>	901038	<b>Ref. No.</b>	30313 30798 33695
<b>description</b>	refrigeration gasket profile 9773 W 659mm L 1539mm external size W1 646mm L1 1526mm plug size		

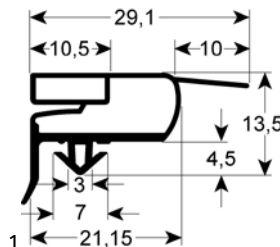
			
<b>Part No.</b>	901041	<b>Ref. No.</b>	33698
<b>description</b>	refrigeration gasket profile 9773 W 699mm L 724mm external size W1 686mm L1 711mm plug size		

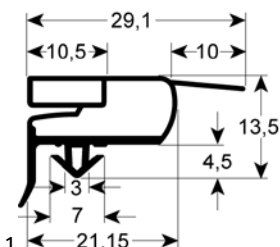
			
<b>Part No.</b>	901042	<b>Ref. No.</b>	31262
<b>description</b>	refrigeration gasket profile 9773 W 669mm L 1539mm external size W1 656mm L1 1526mm plug size		

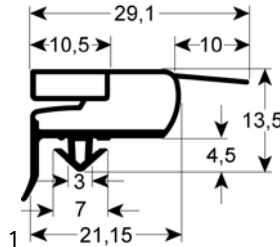
			
<b>Part No.</b>	901155	<b>Ref. No.</b>	33994 34518 R_34518
<b>description</b>	refrigeration gasket profile 9773 W 700mm L 1505mm external size W1 687mm L1 1492mm plug size		



<b>Part No.</b>	902305	<b>Ref. No.</b>	N/A
<b>description</b>	refrigeration gasket profile 9773 Wmm L 2500mm		

profile 9753

We offer custom-made gaskets for this profile

<b>Part No.</b>	901466	<b>Ref. No.</b>	00103
<b>description</b>	refrigeration gasket profile 9753 W 405mm L 640mm plug size		

<b>Part No.</b>	901467	<b>Ref. No.</b>	00104
<b>description</b>	refrigeration gasket profile 9753 W 475mm L 635mm plug size		

profile 9010

We offer custom-made gaskets for this profile

<b>Part No.</b>	901468	<b>Ref. No.</b>	34520
<b>description</b>	refrigeration gasket profile 9010 W 675mm L 1520mm plug size		

<b>Part No.</b>	901469	<b>Ref. No.</b>	31443
<b>description</b>	refrigeration gasket profile 9010 W 675mm L 1555mm plug size		

profile 9794

We offer custom-made gaskets for this profile

<b>Part No.</b>	901870	<b>Ref. No.</b>	R_36474
<b>description</b>	refrigeration gasket profile 9794 W 274mm L 385mm plug size refrigerated counter		

<b>Part No.</b>	901364	<b>Ref. No.</b>	36472 R_36472
<b>description</b>	refrigeration gasket profile 9794 W 390mm L 615mm plug size		

<b>Part No.</b>	901183	<b>Ref. No.</b>	36471 R_36471
<b>description</b>	refrigeration gasket profile 9794 W 461mm L 613mm plug size		

<b>Part No.</b>	902144	<b>Ref. No.</b>	R_35840
<b>description</b>	refrigeration gasket profile 9794 W 665mm L 1505mm plug size L1 1485mm W1 645mm external size suitable for ILSA		



<b>Part No.</b>	902308	<b>Ref. No.</b>	N/A
<b>description</b>	refrigeration gasket profile 9794 Wmm L 2500mm		

profile 9195

We offer custom-made gaskets for this profile

<b>Part No.</b>	901470	<b>Ref. No.</b>	34285
<b>description</b>	refrigeration gasket profile 9195 W 760mm L 1900mm plug size		

gaskets for heated units

door seals with fixing hook

<b>Part No.</b>	692546 <sup>1</sup>	<b>Ref. No.</b>	60045 R_60045
<b>description</b>	door seal L 255mm W 630mm 3-sided long side open with 6 mounting clips		

<sup>1</sup>3-sided, long side open

O-rings

EPDM

<b>Part No.</b>	540682	<b>Ref. No.</b>	18595
<b>description</b>	O-ring EPDM thickness 1.78mm ID ø 18.77mm Qty 1 pcs		

<b>Part No.</b>	510072	<b>Ref. No.</b>	ID0087
<b>description</b>	O-ring EPDM thickness 3.53mm ID ø 32.93mm Qty 1 pcs		

<b>Part No.</b>	532545	<b>Ref. No.</b>	ID0088
<b>description</b>	O-ring Viton thickness 3.53mm ID ø 49.21mm Qty 1 pcs		

evaporators

for fridges

producer-specific

<b>Part No.</b>	750455	<b>Ref. No.</b>	30321 R_30321
<b>description</b>	evaporator L 140mm W 330mm H 170mm D 170mm refrigerator suitable for ILSA		

<b>Part No.</b>	750454	<b>Ref. No.</b>	R_34010
<b>description</b>	evaporator L 260mm W 340mm H 140mm Dmm refrigerator suitable for ILSA		

<b>Part No.</b>	750450	<b>Ref. No.</b>	19619
<b>description</b>	evaporator L 490mm H 70mm W 395mm for refrigerated counters suitable for ILSA		





			
1			
<b>Part No.</b>	750449	<b>Ref. No.</b>	31455 R_19302
<b>description</b>	evaporator L 490mm W 295mm H 70mm refrigerated counter suitable for ILSA		

## evaporation and condensing trays

### unheated condensing trays

			
1			
<b>Part No.</b>	750453	<b>Ref. No.</b>	30085 R_30085
<b>description</b>	condensing tray L 590mm W 105mm H 26mm plastic		

## springs

### tension springs







			
1			
<b>Part No.</b>	692082	<b>Ref. No.</b>	00781
<b>description</b>	torsion spring ø 16mm total length 123mm wire gauge ø 2mm L1 100mm		



			
1			
<b>Part No.</b>	692081	<b>Ref. No.</b>	00782
<b>description</b>	torsion spring ø 16mm total length 123mm wire gauge ø 2mm L1 100mm mounting pos. left		

## valves and tank inlets



### shut-off valves

#### universal

			
1			
<b>Part No.</b>	514060	<b>Ref. No.</b>	60902
<b>description</b>	shut-off valve connection 1/2" 1/2" without handle total length 45mm mounting pos. left shaft L 47mm rosette thread G2 26x19G shaft ø 8x10mm		
<b>spare parts for</b>	514060		
	<b>Part No.</b>	112763	<b>Ref. No.</b> —
	knob connection hot total lengthmm ø 70mm black/silver shaft ø 10x8mm shaft flat universal t.max.°C°C		
	<b>Part No.</b>	112764	<b>Ref. No.</b> —
	knob connection cold total lengthmm ø 70mm black/silver shaft ø 10x8mm shaft flat universal t.max.°C°C		
	<b>Part No.</b>	514085	<b>Ref. No.</b> —
	rosette connection 26x19G chrome-plated total lengthmm mounting pos.		
	<b>Part No.</b>	514086	<b>Ref. No.</b> —
	hexagonal nut connection 26x19G brass total lengthmm mounting pos. H 6mm WS 34 Qty 1 pcs		
	<b>Part No.</b>	548423	<b>Ref. No.</b> —
	tap head connection 1/2" total length 110mm mounting pos. shaft ø 10x8mm		

			
1			
<b>Part No.</b>	540935	<b>Ref. No.</b>	110120
<b>description</b>	shut-off valve connection tube ø 10mm total length 110mm shaft 7x7mm		
<b>accessories for</b>	540935		
	<b>Part No.</b>	110287	<b>Ref. No.</b> —
	knob water t.max.°C temperature range°C ø 50mm shaft ø 7x7mm shaft flat black		



			
1			
<b>Part No.</b>	541982	<b>Ref. No.</b>	115120
<b>description</b>	slide connection 1/2" IT - 1/2" IT mounting thread M27x1,5		
<b>accessories for</b>	541982		
			
<b>Part No.</b>	547713	<b>Ref. No.</b>	—
<b>description</b>	cross handle shaft intake ø 8mm marking blue type F suitable for MONOLITH		

## measuring equipment

### thermometers

#### built-in thermometers

			
1			
<b>Part No.</b>	541670	<b>Ref. No.</b>	18683
<b>description</b>	thermometer mounting measurements 58x25.5mm -40 up to +40°C capillary pipe 1500mm probe ø 6mm probe L 35mm		

**GASTRO**PARTS.COM

