



**GASTROPARTS**

# IGF

- [EN]** Equipment
- [DE]** Geräte
- [ES]** Aparatos
- [FR]** Équipement
- [IT]** Attrezzature
- [PL]** Urządzenia
- [RU]** Оборудование

✉ [gastroparts@gastroparts.com](mailto:gastroparts@gastroparts.com)

☎ +48 56 657 00 66

📘 [fb.com/gastroparts.global](https://fb.com/gastroparts.global)

**GASTROPARTS.COM**





switches and momentary switches

rocker/momentary rocker switches

30x22mm



1

<b>Part No.</b>	301003	<b>Ref. No.</b>	2300/L40PZ24
<b>description</b>	rocker switch mounting measurements 30x22mm green 2NO 250V 16A illuminated 0-I connection male faston 6.3mm ambient temperature max. 125/55°C protection IP65		
<b>For models:</b>	2300-L40P		
<b>accessories for</b>	301003		
	<b>Part No.</b>	301036	<b>Ref. No.</b> —
	protective cover internal size 30x22mm for rocker switch mounting measurementsmm		

push/momentary push switches

ø22.3mm



1

<b>Part No.</b>	346444	<b>Ref. No.</b>	2300/B30Z06 2300/B40PZ05 2300/B40Z06
<b>description</b>	push switch mounting ø 22mm blue 1NO 240V 3A		
<b>For models:</b>	2300-B30, 2300-B40, 2300-B40P		

rotary switches

GIOVENZANA

rotary switches



1

<b>Part No.</b>	347612	<b>Ref. No.</b>	2200/ S16Z35
<b>description</b>	rotary switch 2 0-1 sets of contacts 3 type PO20 690V 12A shaft ø 8x8mm shaft L 25mm shaft square connection screw		
<b>For models:</b>	2200-S16Z		

foot switches



1

<b>Part No.</b>	346442	<b>Ref. No.</b>	2300/B30Z22 2300/B40PZ20 2300/B40Z22 2300/L30Z22 2300/L40PZ20 2300/L40Z22
<b>description</b>	foot switch		
<b>For models:</b>	2300-B30, 2300-B40, 2300-B40P, 2300-L30, 2300-L40, 2300-L40P		

electronics

PCBs



1

<b>Part No.</b>	697124	<b>Ref. No.</b>	2200/S25TZ2
<b>description</b>	PCB 230/400V		



1

<b>Part No.</b>	346446	<b>Ref. No.</b>	2300/B30Z10 2300/B40PZ07 2300/B40Z10
<b>description</b>	PCB dough rolling machine 2300-B30/B40 230V		
<b>For models:</b>	2300-B30, 2300-B40, 2300-B40P		



1

<b>Part No.</b>	346445	<b>Ref. No.</b>	2300/L30Z10 2300/L40PZ07 2300/L40Z10
<b>description</b>	PCB dough rolling machine 2300-L30/L40 B202031 110-240V		
<b>For models:</b>	2300-L30, 2300-L40, 2300-L40P		



## keypads

## membrane keypads



1

<b>Part No.</b>	346443	<b>Ref. No.</b>	2300/L30Z06 2300/L40PZ05 2300/L40Z06
<b>description</b>	membrane keypad dough rolling machine L30-B30-L40-B40 L 70mm W 60mm		
<b>For models:</b>	2300-L30, 2300-L40, 2300-L40P		

## motors

## motors

## universal



1

<b>Part No.</b>	500870	<b>Ref. No.</b>	2300/B30Z15 2300/B40pZ15 2300/B40Z15 2300/L30Z15 2300/L40pZ15 2300/L40Z15
<b>description</b>	motor 370W 230V 50Hz 1 phase shaft $\varnothing$ 14mm 1400rpm type M71BL4T $\varnothing$ 140mm H 180mm L 210mm fixing dimensions 90x112mm ICME 0.37kW		
<b>For models:</b>	2300-B30, 2300-B40, 2300-L30, 2300-L40		
<b>spare parts for</b>	500870		
	<b>Part No.</b>	521022	<b>Ref. No.</b> —
fanwheel cover ID $\varnothing$ 137mm ED $\varnothing$ 142mm H 70mm for wash pump			

## equipment-specific units

## for dough mixers

## drive shafts



1

<b>Part No.</b>	698188	<b>Ref. No.</b>	2400/S25Z43
<b>description</b>	drive shaft D1 $\varnothing$ 38mm for dough hook $\varnothing$ 35mm L 110mm ID $\varnothing$ 20mm		
<b>For models:</b>	2400-S25		

## spacer rings



1

<b>Part No.</b>	698189	<b>Ref. No.</b>	2400/S25Z40
<b>description</b>	spacer ring $\varnothing$ 40mm ID $\varnothing$ 35mm H 22mm		
<b>For models:</b>	2400-S25		

## gear wheels



1

<b>Part No.</b>	698187	<b>Ref. No.</b>	2400/S25Z38
<b>description</b>	sprocket-wheel DIN/ISO 06 B-1 splitting 3/8" teeth 15 shaft intake $\varnothing$ 35mm H 27mm 25		
<b>For models:</b>	2400-S25		

1

<b>Part No.</b>	697776	<b>Ref. No.</b>	2200/S38Z01
<b>description</b>	sprocket-wheel DIN/ISO 08 B-1 splitting 1/2" teeth 15 shaft intake $\varnothing$ 20mm H 28mm		
<b>For models:</b>	2200-S38		

## for dough roller

## wipers



1

<b>Part No.</b>	693694	<b>Ref. No.</b>	2300/B30Z31 2300/L30Z31
<b>description</b>	wiper for dough roller L 305mm mounting pos. front L30-B30		
<b>For models:</b>	2300-B30, 2300-L30		

1

<b>Part No.</b>	693693	<b>Ref. No.</b>	2300/B30Z32 2300/L30Z32
<b>description</b>	wiper for dough roller L 305mm mounting pos. rear L30-B30		
<b>For models:</b>	2300-B30, 2300-L30		



1



<b>Part No.</b>	693696	<b>Ref. No.</b>	2300/B40PZ29 2300/B40Z31 2300/L40PZ29 2300/L40Z31
<b>description</b>	wiper for dough roller L 405mm mounting pos. front total length 450mm L40-B40-L40P-B40P		
<b>For models:</b>	2300-B40, 2300-B40P, 2300-L40, 2300-L40P		

1



<b>Part No.</b>	693695	<b>Ref. No.</b>	2300/B40PZ30 2300/B40Z32 2300/L40PZ30 2300/L40Z32
<b>description</b>	wiper for dough roller L 405mm mounting pos. rear total length 450mm L40-B40-L40P-B40P		
<b>For models:</b>	2300-B40, 2300-B40P, 2300-L40, 2300-L40P		

rollers

1



<b>Part No.</b>	693680	<b>Ref. No.</b>	2300/B30Z46 2300/L30Z46
<b>description</b>	roller for dough roller L 176mm ø 48mm mounting pos. upper at the back		
<b>For models:</b>	2300-B30, 2300-L30		

1



<b>Part No.</b>	693681	<b>Ref. No.</b>	2300/B30Z50 2300/L30Z50
<b>description</b>	roller for dough roller L 176mm ø 48mm mounting pos. upper in the front		
<b>For models:</b>	2300-B30, 2300-L30		

1



<b>Part No.</b>	693682	<b>Ref. No.</b>	2300/B40Z46 2300/L40Z46
<b>description</b>	roller for dough roller L 218mm ø 48mm mounting pos. upper at the back		
<b>For models:</b>	2300-B40, 2300-L40		

1



<b>Part No.</b>	693683	<b>Ref. No.</b>	2300/B40Z50 2300/L40Z50
<b>description</b>	roller for dough roller L 218mm ø 48mm mounting pos. upper in the front		
<b>For models:</b>	2300-B40, 2300-L40		

1



<b>Part No.</b>	693684	<b>Ref. No.</b>	2300/B40PZ44 2300/L40PZ44
<b>description</b>	roller for dough roller L 308mm ø 46mm mounting pos. upper at the back		
<b>For models:</b>	2300-B40P, 2300-L40P		

1



<b>Part No.</b>	693685	<b>Ref. No.</b>	2300/B40PZ48 2300/L40PZ48
<b>description</b>	roller for dough roller L 308mm ø 46mm mounting pos. upper in the front		
<b>For models:</b>	2300-B40P, 2300-L40P		

1



<b>Part No.</b>	693675	<b>Ref. No.</b>	2300/B30Z29 2300/L30Z29
<b>description</b>	roller for dough roller L 308mm ø 49mm mounting pos. bottom at the back		
<b>For models:</b>	2300-B30, 2300-L30		

1



<b>Part No.</b>	693676	<b>Ref. No.</b>	2300/B30Z30 2300/L30Z30
<b>description</b>	roller for dough roller L 308mm ø 49mm mounting pos. bottom in the front		
<b>For models:</b>	2300-B30, 2300-L30		



			
1			
<b>Part No.</b>	693677	<b>Ref. No.</b>	2300/B40PZ27 2300/B40Z29 2300/L40PZ27 2300/L40Z29
<b>description</b>	roller for dough roller L 408mm ø 49mm mounting pos. bottom at the back		
<b>For models:</b>	2300-B40, 2300-B40P, 2300-L40, 2300-L40P		

			
1			
<b>Part No.</b>	693659	<b>Ref. No.</b>	2300/B40PZ28 2300/B40Z30 2300/L40PZ28 2300/L40Z30
<b>description</b>	roller for dough roller L 408mm ø 49mm mounting pos. bottom in the front		
<b>For models:</b>	2300-B40, 2300-B40P, 2300-L40, 2300-L40P		

## holders

			
1			
<b>Part No.</b>	693667	<b>Ref. No.</b>	2300/B30Z40 2300/B40PZ38 2300/B40Z40 2300/L30Z40 2300/L40PZ38 2300/L40Z40
<b>description</b>	lever hole ø 10mm H 21mm hole distance 31mm		
<b>For models:</b>	2300-B30, 2300-B40, 2300-B40P, 2300-L30, 2300-L40, 2300-L40P		

## couplings

			
1			
<b>Part No.</b>	693661	<b>Ref. No.</b>	2300/B30Z35 2300/B40PZ33 2300/B40Z35 2300/L30/L40/B30/B40 Pos. 35 2300/L30Z35 2300/L40PZ33 2300/L40Z35
<b>description</b>	coupling set ø 42mm ID ø 26mm H 23mm		
<b>For models:</b>	2300-B30, 2300-B40, 2300-B40P, 2300-L30, 2300-L40, 2300-L40P		

## pulleys

			
1			
<b>Part No.</b>	693697 <sup>1</sup>	<b>Ref. No.</b>	2300/B30Z12 2300/B40PZ9 2300/B40Z12 2300/L30Z12 2300/L40PZ9 2300/L40Z12
<b>description</b>	V-belt pulley double disc ø 73mm shaft intake ø 14mm groove depth 10mm disc width 32mm groove width 6mm overall width 32mm metal L30-B30-L40-B40		
<b>For models:</b>	2300-B30, 2300-B40, 2300-L30, 2300-L40		

<sup>1</sup>double

			
1			
<b>Part No.</b>	693699	<b>Ref. No.</b>	2300/B40PZ17 2300/L40PZ17
<b>description</b>	V-belt pulley single disc ø 85mm shaft intake ø 14mm groove depth 11mm disc width 25mm groove width 9mm overall width 29mm metal L40P-B40P shaft ø 35mm		
<b>For models:</b>	2300-B40P, 2300-L40P		

			
1			
<b>Part No.</b>	693698	<b>Ref. No.</b>	2300/B30Z13 2300/B40PZ10 2300/B40Z13 2300/L30Z13 2300/L40PZ10 2300/L40Z13
<b>description</b>	V-belt pulley single disc ø 98mm shaft intake ø 14mm groove depth 11mm disc width 13mm groove width 9mm overall width 24mm metal L30-B30-L40-B40 shaft ø 35mm		
<b>For models:</b>	2300-B30, 2300-B40, 2300-B40P, 2300-L30, 2300-L40, 2300-L40P		



pinions

rear mounting



1

<b>Part No.</b>	693664	<b>Ref. No.</b>	2300/B30Z43 2300/B40PZ41 2300/B40Z43 2300/L30Z43 2300/L40PZ41 2300/L40Z43
<b>description</b>	pinion ø 47mm H 33.5mm mounting pos. rear ID ø 25mm for dough roller		
<b>For models:</b>	2300-B30, 2300-B40, 2300-B40P, 2300-L30, 2300-L40, 2300-L40P		

front mounting



1

<b>Part No.</b>	693662	<b>Ref. No.</b>	2300/B30Z36 2300/B40PZ34 2300/B40Z36 2300/L30/L40/B30/B40Pos. 36 2300/L30Z36 2300/ L40PZ34 2300/L40Z36
<b>description</b>	pinion ø 47mm H 33.5mm mounting pos. front ID ø 14mm for dough roller		
<b>For models:</b>	2300-B30, 2300-B40, 2300-B40P, 2300-L30, 2300-L40, 2300-L40P		

roller covers

bottom



1

<b>Part No.</b>	697521	<b>Ref. No.</b>	2300/L30Z01
<b>description</b>	hand protection mounting pos. lower L 350mm W 58mm H 86mm L30-B30		
<b>For models:</b>	2300-L30		



1

<b>Part No.</b>	697520	<b>Ref. No.</b>	2300/B40Z01 2300/L40Z01
<b>description</b>	hand protection mounting pos. lower L 450mm W 58mm H 86mm L40-B40-L40P-B40P		
<b>For models:</b>	2300-B40, 2300-L40		

side parts



1

<b>Part No.</b>	693665	<b>Ref. No.</b>	2300/B30Z42 2300/B40PZ40 2300/L30Z42 2300/L40PZ40 2300/L40Z42
<b>description</b>	side panel for dough roller mounting pos. bottom right W 40mm L 125mm H 100mm L30-B30-L40-B40		
<b>For models:</b>	2300-B30, 2300-B40P, 2300-L30, 2300-L40, 2300-L40P		



1

<b>Part No.</b>	693679	<b>Ref. No.</b>	2300/B30Z48 2300/B40PZ46 2300/B40Z48 2300/L30Z48 2300/L40PZ46 2300/L40Z48
<b>description</b>	side panel for dough roller mounting pos. upper right W 40mm L 125mm H 100mm L30-B30-L40-B40		
<b>For models:</b>	2300-B30, 2300-B40, 2300-B40P, 2300-L30, 2300-L40, 2300-L40P		



			
1			
<b>Part No.</b>	693669	<b>Ref. No.</b>	2300/B30Z28 2300/B40PZ26 2300/B40Z28 2300/L30Z28 2300/L40PZ26 2300/L40Z28
<b>description</b>	side panel for dough roller mounting pos. bottom left W 25mm L 122mm H 80mm L30-B30-L40-B40		
<b>For models:</b>	2300-B30, 2300-B40, 2300-B40P, 2300-L30, 2300-L40, 2300-L40P		

			
2			
<b>Part No.</b>	693678	<b>Ref. No.</b>	2300/B30Z45 2300/B40PZ43 2300/B40Z45 2300/L30Z45 2300/L40PZ43 2300/L40Z45
<b>description</b>	side panel for dough roller mounting pos. upper left W 25mm L 115mm H 80mm L30-B30-L40-B40		
<b>For models:</b>	2300-B30, 2300-B40, 2300-B40P, 2300-L30, 2300-L40, 2300-L40P		

## spindles

			
1			
<b>Part No.</b>	693666	<b>Ref. No.</b>	2300/B30Z39 2300/B40PZ37 2300/B40Z39 2300/L30Z39 2300/L40PZ37 2300/L40Z39
<b>description</b>	spindle ø 24mm L 161mm		
<b>For models:</b>	2300-B30, 2300-B40, 2300-B40P, 2300-L30, 2300-L40, 2300-L40P		

## bars

			
1			
<b>Part No.</b>	693670	<b>Ref. No.</b>	2300/B30Z33 2300/L30Z33
<b>description</b>	bar ø 5mm L 328mm L30-B30		
<b>For models:</b>	2300-B30, 2300-L30		

			
1			
<b>Part No.</b>	693671	<b>Ref. No.</b>	2300/B40PZ31 2300/B40Z33 2300/L40PZ31 2300/L40Z33
<b>description</b>	bar ø 5mm L 428mm L40-B40-L40P-B40P		
<b>For models:</b>	2300-B40, 2300-B40P, 2300-L40, 2300-L40P		

## spindles

## eccentric

			
1			
<b>Part No.</b>	693689	<b>Ref. No.</b>	2300/B30Z49 2300/L30Z49
<b>description</b>	spindle ø 25mm L 248mm mounting pos. upper in the front eccentric for dough roller		
<b>For models:</b>	2300-B30, 2300-L30		

			
1			
<b>Part No.</b>	693690	<b>Ref. No.</b>	2300/B40Z49 2300/L40Z49
<b>description</b>	spindle ø 25mm L 288mm mounting pos. upper in the front eccentric for dough roller		
<b>For models:</b>	2300-B40, 2300-L40		

			
1			
<b>Part No.</b>	693660	<b>Ref. No.</b>	2300/B30Z34 2300/L30Z34
<b>description</b>	spindle ø 25mm L 378mm mounting pos. bottom in the front eccentric for dough roller		
<b>For models:</b>	2300-B30, 2300-L30		

			
1			
<b>Part No.</b>	693691	<b>Ref. No.</b>	2300/B40PZ47 2300/L40PZ47
<b>description</b>	spindle ø 25mm L 378mm mounting pos. upper in the front eccentric for dough roller		
<b>For models:</b>	2300-B40P, 2300-L40P		

			
1			
<b>Part No.</b>	693674	<b>Ref. No.</b>	2300/B40Z34 2300/L40PZ32 2300/L40Z34
<b>description</b>	spindle ø 25mm L 478mm mounting pos. bottom in the front eccentric for dough roller		
<b>For models:</b>	2300-B40, 2300-L40, 2300-L40P		

## cylindric

			
1			
<b>Part No.</b>	693686	<b>Ref. No.</b>	2300/B30Z47 2300/L30Z47
<b>description</b>	spindle ø 25mm L 218mm mounting pos. upper at the back cylindrical for dough roller		
<b>For models:</b>	2300-B30, 2300-L30		

			
1			
<b>Part No.</b>	693687	<b>Ref. No.</b>	2300/B40Z47 2300/L40Z47
<b>description</b>	spindle ø 25mm L 260mm mounting pos. upper at the back cylindrical for dough roller		
<b>For models:</b>	2300-B40, 2300-L40		



1 

<b>Part No.</b>	693673	<b>Ref. No.</b>	2300/B30Z44 2300/L30Z44
<b>description</b>	spindle ø 25mm L 350mm mounting pos. bottom at the back cylindrical for dough roller		
<b>For models:</b>	2300-B30, 2300-L30		

1 

<b>Part No.</b>	693688	<b>Ref. No.</b>	2300/B40PZ45 2300/L40PZ45
<b>description</b>	spindle ø 25mm L 350mm mounting pos. upper at the back cylindrical for dough roller		
<b>For models:</b>	2300-B40P, 2300-L40P		

1 

<b>Part No.</b>	693672	<b>Ref. No.</b>	2300/B40PZ44 2300/B40Z44 2300/L40PZ44 2300/L40Z44
<b>description</b>	spindle ø 25mm L 450mm mounting pos. bottom at the back cylindrical for dough roller		
<b>For models:</b>	2300-B40, 2300-L40		

miscellaneous

1 

<b>Part No.</b>	693706	<b>Ref. No.</b>	2300/B30Z18 2300/B40PZ15 2300/B40Z18 2300/L30Z18 2300/L40PZ15 2300/L40Z18
<b>description</b>	fan wheel ø 110mm H 16mm		
<b>For models:</b>	2300-B30, 2300-B40, 2300-B40P, 2300-L30, 2300-L40, 2300-L40P		

1 

<b>Part No.</b>	693668	<b>Ref. No.</b>	2300/B30Z38 2300/B40PZ36 2300/B40Z38 2300/L30Z38 2300/L40PZ36 2300/L40Z38
<b>description</b>	lid for side part ø 30.5mm H 7mm		
<b>For models:</b>	2300-B30, 2300-B40, 2300-B40P, 2300-L30, 2300-L40, 2300-L40P		

for tilting bratt pans

miscellaneous

1 

<b>Part No.</b>	523510	<b>Ref. No.</b>	2300/B30Z41 2300/B40PZ39 2300/B40Z41 2300/L30Z41 2300/L40PZ39 2300/L40Z41
<b>description</b>	deep-groove ball bearing type 6202-2RS shaft ø 15mm ED ø 35mm W 11mm with sealing discs deep-groove ball bearing DIN 625-1		
<b>For models:</b>	2300-B30, 2300-B40, 2300-B40P, 2300-L30, 2300-L40, 2300-L40P		

for pizza ovens

firebricks

1 

<b>Part No.</b>	850092	<b>Ref. No.</b>	K65/105 14
<b>description</b>	firebrick L 1025mm W 605mm H 15mm mounting pos. lower delivery freight forwarding company only		

transmission technology and ball bearings

ball bearings

deep-groove ball bearings 2RS

1 

<b>Part No.</b>	523528	<b>Ref. No.</b>	2400/S25Z39 2400/S25Z41
<b>description</b>	deep-groove ball bearing type 6007-2RS shaft ø 35mm ED ø 62mm W 14mm with sealing discs deep-groove ball bearing DIN 625-1		
<b>For models:</b>	2400-S25		



1

<b>Part No.</b>	523510	<b>Ref. No.</b>	2300/B30Z41 2300/B40PZ39 2300/B40Z41 2300/L30Z41 2300/L40PZ39 2300/L40Z41
<b>description</b>	deep-groove ball bearing type 6202-2RS shaft $\varnothing$ 15mm ED $\varnothing$ 35mm W 11mm with sealing discs deep-groove ball bearing DIN 625-1		
<b>For models:</b>	2300-B30, 2300-B40, 2300-B40P, 2300-L30, 2300-L40, 2300-L40P		



1

<b>Part No.</b>	523512	<b>Ref. No.</b>	2200/S38Z04
<b>description</b>	deep-groove ball bearing type 6204-2RS shaft $\varnothing$ 20mm ED $\varnothing$ 47mm W 14mm with sealing discs deep-groove ball bearing DIN 625-1		
<b>For models:</b>	2200-S38		

deep-groove ball bearings 2Z



1

<b>Part No.</b>	523508	<b>Ref. No.</b>	2300/B30Z37 2300/B40PZ35 2300/B40Z37 2300/L30/L40/B30/B40 Pos. 37 2300/L30Z37 2300/L40PZ35 2300/L40Z37
<b>description</b>	deep-groove ball bearing shaft $\varnothing$ 10mm ED $\varnothing$ 30mm W 9mm type 6200-2Z DIN 625-1		
<b>For models:</b>	2300-B30, 2300-B40, 2300-B40P, 2300-L30, 2300-L40, 2300-L40P		

angular contact ball bearings



1

<b>Part No.</b>	697116	<b>Ref. No.</b>	2200/S38Z02
<b>description</b>	angular contact ball bearing shaft $\varnothing$ 20mm ED $\varnothing$ 47mm W 20.6mm type 3204-2RS DIN 628		
<b>For models:</b>	2200-S38		

drive belts

round belts

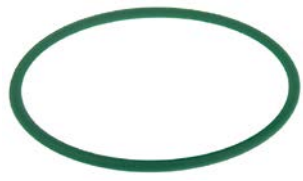

1

<b>Part No.</b>	693701	<b>Ref. No.</b>	2300/B30Z19 2300/L30Z19
<b>description</b>	round belt $\varnothing$ 8mm L 540mm		
<b>For models:</b>	2300-B30, 2300-L30		

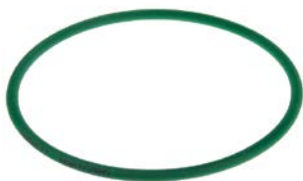

1

<b>Part No.</b>	693705	<b>Ref. No.</b>	2300/B40PZ16 2300/L40PZ16
<b>description</b>	round belt $\varnothing$ 8mm L 620mm		
<b>For models:</b>	2300-B40P, 2300-L40P		



1

<b>Part No.</b>	693703	<b>Ref. No.</b>	2300/B40Z19 2300/L40Z19
<b>description</b>	round belt $\varnothing$ 8mm L 635mm		
<b>For models:</b>	2300-B40, 2300-L40		



1

<b>Part No.</b>	693700	<b>Ref. No.</b>	2300/B30Z14 2300/L30Z14
<b>description</b>	round belt $\varnothing$ 8mm L 645mm		
<b>For models:</b>	2300-B30, 2300-L30		



1

<b>Part No.</b>	693704	<b>Ref. No.</b>	2300/B40PZ11 2300/L40PZ11
<b>description</b>	round belt $\varnothing$ 8mm L 884mm		
<b>For models:</b>	2300-B40P, 2300-L40P		



			
1			
<b>Part No.</b>	693702	<b>Ref. No.</b>	2300/B40Z14 2300/L40Z14
<b>description</b>	round belt ø 8mm L 895mm		
<b>For models:</b>	2300-B40, 2300-L40		

			
1			
<b>Part No.</b>	694512	<b>Ref. No.</b>	2300/B30Z27 2300/B40PZ25 2300/B40Z27 2300/L30Z27 2300/L40PZ25 2300/L40Z27
<b>description</b>	spring ø 14mm for dough roller L2 60mm mounting pos. in the front/ at the back L 80mm wire gauge ø 2mm L1 4mm L3 20mm Qty 1 pcs		
<b>For models:</b>	2300-B30, 2300-B40, 2300-B40P, 2300-L30, 2300-L40, 2300-L40P		

## springs

### torsion springs

			
1			
<b>Part No.</b>	693692	<b>Ref. No.</b>	2300/B30Z27 2300/B40PZ25 2300/B40Z27 2300/L30Z27 2300/L40PZ25 2300/L40Z27
<b>description</b>	spring for dough roller mounting pos. in the front/at the back		

**GASTRO**PARTS.COM

