



GASTROPARTS

Icos

- [EN]** Equipment
- [DE]** Geräte
- [ES]** Aparatos
- [FR]** Équipement
- [IT]** Attrezzature
- [PL]** Urządzenia
- [RU]** Оборудование

✉ gastroparts@gastroparts.com

☎ +48 56 657 00 66

📘 fb.com/gastroparts.global

GASTROPARTS.COM





heating elements



immersion heating elements

with round flange ø57.5mm



Part No.	418040	Ref. No.	10062 39.802.01557
description	heating element 6000W 230V heating circuits 3 L 385mm W 32mm H 42mm tube ø 6.3mm thermostat sleeves ø 7mm length thermostat sleeves 275mm number of thermostat sleeves 1 thermostat sleeve clinging connection male faston 6.3mm connection length 27mm immersion heater round flange mounting ø 57.5mm		
accessories for	418040		
	Part No.	550002	Ref. No. —
	tension strap H 10mm L 21mm W 10mm hole ø 6.5mm for heating element		



Part No.	418041	Ref. No.	16600
description	heating element 8000W 230V heating circuits 3 L 470mm W 42mm H 31mm tube ø 6.4mm thermostat sleeves ø 7mm length thermostat sleeves 278mm number of thermostat sleeves 1 thermostat sleeve clinging connection male faston 6.3mm connection length 27mm immersion heater round flange mounting ø 57.5mm		
spare parts for	418041		
	Part No.	510409	Ref. No. —
	O-ring EPDM thickness 5.34mm ID ø 56.52mm Qty 1 pcs		
accessories for	418041		
	Part No.	550002	Ref. No. —
	tension strap H 10mm L 21mm W 10mm hole ø 6.5mm for heating element		



Part No.	416078	Ref. No.	R55100090
description	heating element 8000W 230V heating circuits 3 L 305mm W 39mm H 43mm tube ø 8.5mm thermostat sleeves ø 5mm length thermostat sleeves 285mm number of thermostat sleeves 1 thermostat sleeve clinging connection M4 connection length 48mm immersion heater flange with thread 2"		
accessories for	416078		
	Part No.	510407	Ref. No. —
	flat gasket fibre ED ø 78mm ID ø 60mm thickness 2mm for heating element for thread 2" Qty 1 pcs		

accessories

sealing washers

fibre gaskets

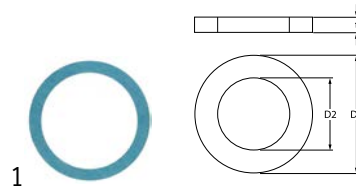

Part No.	510406	Ref. No.	09387 I09387
description	flat gasket fibre ED ø 60mm ID ø 48mm thickness 3mm for thread 1½" Qty 1 pcs		

energy regulators

EGO

1-circuit



Part No.	380015	Ref. No.	07931
description	energy regulator 230V 13A single-circuit turn direction right shaft ø 6x4.6mm shaft L 23mm mounting thread M4 power release 6-100% no. 50.57021.010		

thermostats

control and safety thermostats

EGO

safety thermostats

55.32_ series



Part No.	375622	Ref. No.	I10064
description	safety thermostat switch-off temp. 147°C 1-pole 20A probe ø 6mm probe L 89mm capillary pipe 900mm capillary pipe isolated 800mm gland nut probe		



lamps

indicator lights

indicator lights (complete)

ø12mm

with screw socket



1

Part No.	359048	Ref. No.	13205 39.665.01360 I13205
description	indicator light ø 12mm 230V yellow connection male faston 6.3mm		



1

Part No.	359291	Ref. No.	13218 39.665.01571 I13218
description	indicator light ø 12mm 400V green connection male faston 6.3mm		

contactors

BENEDIKT & JÄGER

power contactors



1

Part No.	381471	Ref. No.	39.815.01371
description	power contactor resistive load 110A 230 (AC3/400V) 22kW main contacts 3NO connection screw type K3-50A00		

GENERAL ELECTRIC (AEG)

power contactors



1

Part No.	380261	Ref. No.	13042
description	power contactor resistive load 32A 230VAC (AC3/400V) 17A/7.5kW main contacts 3NO auxiliary contacts 1NO connection screw connection type AEG LS7K 10A type GE CL02A 310		

miscellaneous

power contactors



1

Part No.	380391	Ref. No.	09313 I09313
description	power contactor 230V resistive load 110A (AC3/400V) 55/30kW main contacts 3NO connection screw		

pressure switches

for steam control



1

Part No.	541350	Ref. No.	16994 39.332.01600
description	pressure control pressure range adjustable 0.3-0.8bar connection 1/4" CO 250V 10A ambient temperature max. 60°C pressure connection 1/4"		



gas taps





PEL

23S/O series



1

Part No.	101091	Ref. No.	10038 39.785.02164
description	gas tap PEL type 23S/O gas inlet M28x1.5 (tube ø 20mm) bypass nozzle ø 0.35mm gas outlet M24x1.5 (tube ø 16mm) thermocouple connection M9x1 pilot connection M10x1 shaft ø 10x8mm shaft L 35/19mm shaft flat upper		
spare parts for	101091		
	Part No.	100455	Ref. No. —
	bypass nozzle type PEL23/24 bore ø 0.35mm thread M8x0.5		
	Part No.	101045	Ref. No. —
	magnet unit T1: M9x1 T2: M22x1 L 46mm ø 18mm suitable for PEL23S M9x1		
	Part No.	101244	Ref. No. —
	gas connection thread M24x1.5 tube ø 12/16mm horizontal for PEL gas taps		
	Part No.	101336	Ref. No. —
	gas tap front part shaft ø 10x8mm shaft L 35/17mm shaft flat upper/lower suitable for PEL23S		
	Part No.	101463	Ref. No. —
	screw suitable for PEL23S Qty 4 pcs		
	Part No.	528455	Ref. No. —
	O-ring Viton thickness 2.62mm ID ø 18.72mm Qty 1 pcs		
accessories for	101091		
	Part No.	100908	Ref. No. —
	union screw thread M10x1 for pipe ø 4mm Qty 1 pcs		
	Part No.	100909	Ref. No. —
	union screw thread M10x1 for pipe ø 6mm Qty 1 pcs		
	Part No.	101246	Ref. No. —
	olive for pipe ø 4mm Qty 1 pcs		
	Part No.	101252	Ref. No. —
	union nut thread M24x1.5 for pipe ø 12mm		
	Part No.	101253	Ref. No. —
	union nut thread M24x1.5 PEL for pipe ø 16mm		
	Part No.	101254	Ref. No. —
	union nut thread M28x1.5 tube ø 20mm		
	Part No.	101255	Ref. No. —
	olive for pipe ø 12mm Qty 1 pcs		
	Part No.	101256	Ref. No. —
	olive for pipe ø 16mm Qty 1 pcs		

accessories for	101091		
	Part No.	101257	Ref. No. —
	olive for pipe ø 20mm Qty 1 pcs		
	Part No.	101286	Ref. No. —
	olive ID ø 6mm Qty 1 pcs		
	Part No.	110080	Ref. No. 15738 39.054.01598
	knob ø 70mm shaft ø 10x8mm shaft flat universal		
	Part No.	112206	Ref. No. —
	knob dial plate silver gas tap PEL21/22/23 t.max.°C ED ø 63mm ID ø 45.5mm		

ignition parts

pilot burners

SIT

100 series

accessories

ignition electrodes



Part No.	100706	Ref. No.	101050 39.085.01563
description	ignition electrode connection M4 Qty 1 pcs		

POLIDORO

pilot burners



1



















Part No.	102800	Ref. No.	08122 39.200.02815
description	pilot burner POLIDORO 3 flames code gas connection 6mm		
spare parts for	102800		
	Part No.	100906	Ref. No. —
	screw connection thread M10x1 for ignition electrode brass Qty 1 pcs WS 10		
	Part No.	100907	Ref. No. —
	screw connection thread M10x1 Qty 1 pcs type SEF 1 ømm for thermocouple		
	Part No.	100909	Ref. No. —
	union screw thread M10x1 for pipe ø 6mm Qty 1 pcs		









Table continues overleaf



spare parts for	102800		
	Part No.	101287	Ref. No. —
	olive for pipe ø 6mm Qty 1 pcs		
accessories for	102800		
	Part No.	100208	Ref. No. —
	pilot burner nozzle POLIDORO LPG code 20 bore ø 0.2mm Qty 1 pcs		
	Part No.	100209	Ref. No. —
	pilot burner nozzle POLIDORO natural gas code 40 bore ø 0.4mm Qty 1 pcs		
	Part No.	100701	Ref. No. —
	ignition electrode connection M4 Qty 1 pcs		
	Part No.	100908	Ref. No. —
	union screw thread M10x1 for pipe ø 4mm Qty 1 pcs		
	Part No.	101280	Ref. No. —
	olive for pipe ø 4mm Qty 1 pcs		

			
1			
Part No.	102876	Ref. No.	10042
description	pilot burner POLIDORO 3 flames code gas connection 6mm		

			
1			
Part No.	100148	Ref. No.	10042
description	pilot burner POLIDORO type A 3 flames LPG code 20 gas connectionmm		
accessories for	100148		
	Part No.	100000	Ref. No. —
	pilot burner nozzle POLIDORO LPG code 22 bore ø 0.22mm Qty 1 pcs		
	Part No.	100208	Ref. No. —
	pilot burner nozzle POLIDORO LPG code 20 bore ø 0.2mm Qty 1 pcs		
	Part No.	100209	Ref. No. —
	pilot burner nozzle POLIDORO natural gas code 40 bore ø 0.4mm Qty 1 pcs		
	Part No.	100701	Ref. No. —
	ignition electrode connection M4 Qty 1 pcs		
	Part No.	100906	Ref. No. —
	screw connection thread M10x1 for ignition electrode brass Qty 1 pcs WS 10		
	Part No.	100907	Ref. No. —
	screw connection thread M10x1 Qty 1 pcs type SEF 1 ømm for thermocouple		
	Part No.	100908	Ref. No. —
	union screw thread M10x1 for pipe ø 4mm Qty 1 pcs		

accessories for	100148		
	Part No.	100909	Ref. No. —
	union screw thread M10x1 for pipe ø 6mm Qty 1 pcs		
	Part No.	102110	Ref. No. —
	pilot tube copper pipe ø 4mm thickness 1mm L 3000mm		
	Part No.	102111	Ref. No. —
	pilot tube copper pipe ø 6mm thickness 1mm L 3000mm		
	Part No.	102699	Ref. No. —
	pilot burner nozzle POLIDORO natural gas code 25.2 bore ø 2x0.25mm Qty 1 pcs 2 bores		
	Part No.	102795	Ref. No. —
	olive for pipe ø 4mm Qty 1 pcs		
	Part No.	102797	Ref. No. —
	olive for pipe ø 6mm Qty 1 pcs		
	Part No.	106703	Ref. No. —
	pilot burner nozzle POLIDORO natural gas code 27.2 bore ø 2x0.27mm Qty 1 pcs		
	Part No.	106704	Ref. No. —
	pilot burner nozzle POLIDORO LPG code 16.2 bore ø 2x0.16mm Qty 1 pcs		
	Part No.	106763	Ref. No. —
	pilot burner nozzle POLIDORO natural gas code 27.2A bore ø 2x 0.27mm Qty 1 pcs		
	Part No.	106859	Ref. No. —
	pilot burner nozzle POLIDORO LPG code 24 bore ø 0.24mm Qty 1 pcs		

electrodes

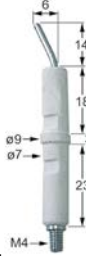
			
1			
Part No.	100706	Ref. No.	101050 39.085.01563
description	ignition electrode connection M4 Qty 1 pcs		

ignition cables

pre-assembled cables			
			
1			
Part No.	100175	Ref. No.	08053 39.662.01619
description	ignition cable cable length 1750mm connection ø2.4mm / ø4mm		



piezoelectric igniters

mounting diameter 18mm





1

Part No.	102877	Ref. No.	10041
description	piezoelectric igniter body plastic blowing mounting ø 18mm connection F2.8x0.8		



1

Part No.	100009	Ref. No.	16132 39.200.02618 113919
description	piezoelectric igniter body plastic blowing mounting ø 18mm connection ø2.4mm front measurements 26mm M18x1.5		
accessories for	100009		
	Part No.	Ref. No.	—
	cover cap for piezoelectric igniter		
	Part No.	Ref. No.	—
	cover cap for piezoelectric igniter ID ø 22mm ED ø 35mm H 25mm		
	Part No.	Ref. No.	—
	cover cap for piezoelectric igniter ID ø 21mm ED ø 36mm		

thermocouples

plug-in thermocouples

plug-in thermocouples standard

with barrel socket ø6(6.5)mm

thermocouples SIT

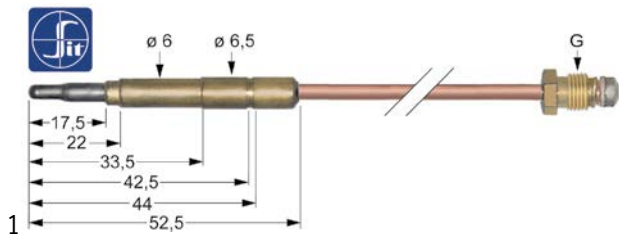

1

Part No.	107621	Ref. No.	10070 39.335.01559
description	thermocouple SIT M10x1 L 1500mm plug connection ø6.0(6.5)mm		

gas burners

bar burners

bar burners



1

Part No.	105319	Ref. No.	52500200
description	bar burner 4 row L 390mm W 270mm ømm H 60mm kettle		



1

Part No.	105330	Ref. No.	052500000 052500000/110053 100000
description	bar burner ø 40mm Wmm Hmm L 500mm mounting thread with bolt M5x12 flange width 43mm flange length 43mm bain marie		



1

Part No.	105920	Ref. No.	10053 39.083.00516 39.083.00516-100 110053
description	bar burner ø 50mm Wmm Hmm L 450mm flange with bolt M4 flange width 65mm flange length 71mm kettle		



1

Part No.	105697	Ref. No.	09485 39.083.00510 39.083.00510-00
description	bar burner ø 50mm Wmm Hmm L 450mm with bolt M5x12 flange width 65mm flange length 71mm kettle		



equipment-specific units

for espresso machines

level glasses

level glasses

level glass pipes



Part No.	514345	Ref. No.	09833 109833
-----------------	--------	-----------------	-----------------

description water level tube ø 10mm H 100mm

for deep fryers

glass panels



Part No.	693397	Ref. No.	10043
-----------------	--------	-----------------	-------

description glass panel L 29mm W 29mm thickness 3.5mm square

for convection ovens/combi-steamers

glass panels



Part No.	693397	Ref. No.	10043
-----------------	--------	-----------------	-------

description glass panel L 29mm W 29mm thickness 3.5mm square

frame



Part No.	693398	Ref. No.	10100 39.201.01562
-----------------	--------	-----------------	-----------------------

description frame for level glass

for tilting bratt pans

glass panels



Part No.	693397	Ref. No.	10043
-----------------	--------	-----------------	-------

description glass panel L 29mm W 29mm thickness 3.5mm square

for boiling pans

lids



Part No.	514128	Ref. No.	E30600420
-----------------	--------	-----------------	-----------

description distance washer for handle

filters



Part No.	514338	Ref. No.	E32300340
-----------------	--------	-----------------	-----------

description drain filter size 12,5x24mm for kettle

glass panels



Part No.	693397	Ref. No.	10043
-----------------	--------	-----------------	-------

description glass panel L 29mm W 29mm thickness 3.5mm square

fittings for catering equipment

aerators and air bleeders



Part No.	540825	Ref. No.	14945 39.302.02286
-----------------	--------	-----------------	-----------------------

description aerator and air bleeder thread 3/8" ET WS 24 chrome-plated L 37mm



lid hinges

type RUBINETTERIE DEL FRIULI

for circular lids

spare parts



1			
Part No.	540855	Ref. No.	08052
description	torsion spring ø 50.8mm wire gauge ø 5.1mm L1 34mm L2 104mm L3 29mm mounting pos. left		



1			
Part No.	540854	Ref. No.	08051
description	torsion spring ø 50.8mm wire gauge ø 5.1mm L1 34mm L2 104mm L3 29mm mounting pos. right		

FIREX

spare parts



1			
Part No.	540855	Ref. No.	08052
description	torsion spring ø 50.8mm wire gauge ø 5.1mm L1 34mm L2 104mm L3 29mm mounting pos. left		



1			
Part No.	540854	Ref. No.	08051
description	torsion spring ø 50.8mm wire gauge ø 5.1mm L1 34mm L2 104mm L3 29mm mounting pos. right		

ICOS



1			
Part No.	514129	Ref. No.	16158 35.809.02539 E30900140 116158
description	adjusting bush L 100mm ø 70/60mm		



1			
Part No.	514136	Ref. No.	02282 10018 39.302.02445 102282 110018
description	bracket for lid hinge		



1			
Part No.	514131	Ref. No.	10005 39.302.02299 110005
description	lid hinge body lid radius 320mm		



1			
Part No.	514132	Ref. No.	10006 39.302.02440 110006
description	lid hinge body lid radius 395mm		



1			
Part No.	514133	Ref. No.	10007 39.302.02538 110007
description	lid hinge body lid radius 500mm		



1

Part No.	514134	Ref. No.	10008 39.302.02537 I10008
description	lid hinge body lid radius 545mm		



1

Part No.	514137	Ref. No.	35.161.01603 E30600470
description	spring guide for lid hinge ID ø 28mm ED ø 32mm L 225mm zinc-coated steel		



1

Part No.	540855	Ref. No.	08052
description	torsion spring ø 50.8mm wire gauge ø 5.1mm L1 34mm L2 104mm L3 29mm mounting pos. left		



1

Part No.	540854	Ref. No.	08051
description	torsion spring ø 50.8mm wire gauge ø 5.1mm L1 34mm L2 104mm L3 29mm mounting pos. right		



1

Part No.	514346	Ref. No.	08008 I08008
description	torsion spring ø 51.5mm wire gauge ø 4.1mm L1 21mm L2 110mm L3 21mm mounting pos. left		



1

Part No.	514339	Ref. No.	08007 I08007
description	torsion spring ø 51.8mm wire gauge ø 4.1mm L1 20mm L2 106mm L3 20mm mounting pos. right		



1

Part No.	514526	Ref. No.	08007+08008 32.400.03398-00
description	torsion spring ø 51mm set wire gauge ø 4mm L1 20mm L2 106mm L3 20mm mounting pos. right and left		



1

Part No.	514352	Ref. No.	08093 I08093
description	torsion spring ø 51mm wire gauge ø 6.5mm L1 28mm L2 101mm L3 28mm mounting pos. left		



1

Part No.	514351	Ref. No.	08083 I08083
description	torsion spring ø 51mm wire gauge ø 6.5mm L1 28mm L2 101mm L3 28mm mounting pos. right		



1

Part No.	514350	Ref. No.	08055 I08055
description	torsion spring ø 51mm wire gauge ø 6mm L1 28mm L2 95mm L3 28mm mounting pos. left		



1

Part No.	514349	Ref. No.	08054 I08054
description	torsion spring ø 51mm wire gauge ø 6mm L1 28mm L2 95mm L3 28mm mounting pos. right		

1

Part No.	514343	Ref. No.	35.802.02504 E30900570
description	adjusting bush		



1

Part No.	514340	Ref. No.	35.802.02506 E30800180
description	bracket mounting pos. left		



1

Part No.	514341	Ref. No.	35.802.02505 E30800170
description	bracket right		



1

Part No.	514128	Ref. No.	E30600420
description	distance washer for handle		



1

Part No.	514135	Ref. No.	09131 I09131
description	handle H 270mm L 890mm W 400mm for kettle		



1

Part No.	514342	Ref. No.	09484 I09484
description	lid for holder		

lid catches

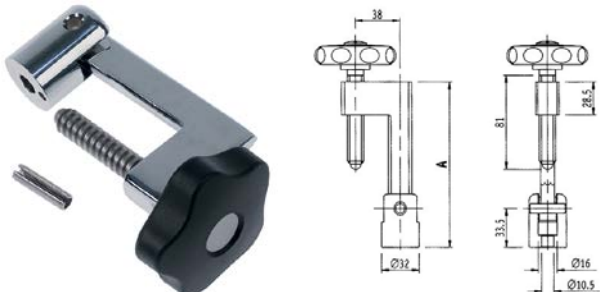

1

Part No.	514127	Ref. No.	10030 14939 39.302.02292
description	lid lock handle \varnothing 70mm L 143mm		





drain taps

brass

drain taps



Part No.	540275	Ref. No.	10027 39.302.01275
description	drain tap 2" IT with union nut A 90mm B 151mm B1 80mm chrome-plated brass		
spare parts for	540275		
	Part No.	540214	Ref. No. —
	handle ID ø 6mm L 145mm		
accessories for	540275		
	Part No.	529484	Ref. No. —
	flat gasket fibre ED ø 58mm ID ø 50mm thickness 2mm Qty 1 pcs		
	Part No.	542448	Ref. No. —
	gasket silicone 60x49x2 for drain tap 2"		

test taps

test taps

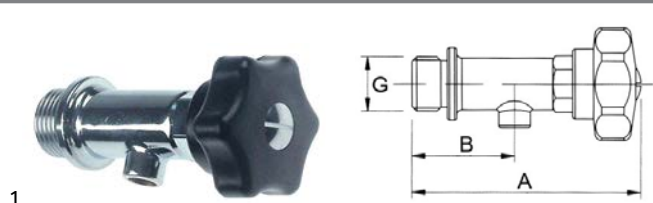

Part No.	540818	Ref. No.	10044
description	test tap thread 1/2" ET W 88mm W1 38mm		

safety fittings

safety fittings



Part No.	514276	Ref. No.	11032 39.392.01566
description	safety fitting thread 3/4" 0.45bar H 165mm ø 65mm		
spare parts for	514276		
	Part No.	514094	Ref. No. —
	angle piece thread 3/8"		
	Part No.	514276	Ref. No. 11032 39.392.01566
	safety fitting thread 3/4" 0.45bar H 165mm ø 65mm		
	Part No.	540825	Ref. No. 14945 39.302.02286
	aerator and air bleeder thread 3/8" ET WS 24 chrome-plated L 37mm		
	Part No.	540828	Ref. No. 10023 39.302.02269
	manometer siphon thread 3/8"		
	Part No.	541579	Ref. No. 10022 39.302.02450
	manometer ø 52mm pressure range 0 up to 1bar connection marking 0.5 thread 1/4"		











Part No.	514275	Ref. No.	17054 39.302.02290
description	safety fitting thread 3/4" 0.45bar with manometer and aerator/air bleeder 3.3kg H 200mm W 150mm		
spare parts for	514275		
	Part No.	514094	Ref. No. —
	angle piece thread 3/8"		
	Part No.	514276	Ref. No. 11032 39.392.01566
	safety fitting thread 3/4" 0.45bar H 165mm ø 65mm		
	Part No.	540825	Ref. No. 14945 39.302.02286
	aerator and air bleeder thread 3/8" ET WS 24 chrome-plated L 37mm		
	Part No.	540828	Ref. No. 10023 39.302.02269
	manometer siphon thread 3/8"		

Table continues overleaf



spare parts for 514275			
	Part No.	541579	Ref. No.
			10022 39.302.02450
manometer ø 52mm pressure range 0 up to 1bar connection marking 0.5 thread 1/4"			

accessories			
	1		
	Part No.	540817	Ref. No.
			10014 39.302.02482
description	fitting support thread 1/2" ET suitable for manometer		

	1		
	Part No.	540835	Ref. No.
			10013
description	screw cap thread 3/4"		
spare parts for 540835			
	Part No.	513016	Ref. No.
			—
O-ring EPDM thickness 3.53mm ID ø 26.58mm Qty 1 pcs			
accessories for 540835			
	Part No.	513016	Ref. No.
			—
O-ring EPDM thickness 3.53mm ID ø 26.58mm Qty 1 pcs			

	1		
	Part No.	540828	Ref. No.
			10023 39.302.02269
description	manometer siphon thread 3/8"		

safety valves			
	1		
	Part No.	540722	Ref. No.
			10004 39.302.02291
description	safety valve with outlet for lid		

gaskets

gaskets for heated units

boiling pan gaskets

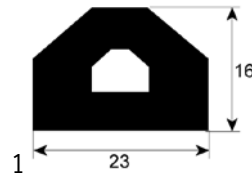

Part No.	900510	Ref. No.	E30100010
description	boiling pan gasket profile 3020 L 2000mm		

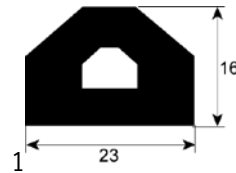

Part No.	900513	Ref. No.	E30100020
description	boiling pan gasket profile 3020 L 2500mm		

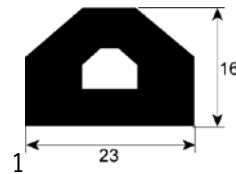

Part No.	900514	Ref. No.	E30100030
description	boiling pan gasket profile 3020 L 3200mm		

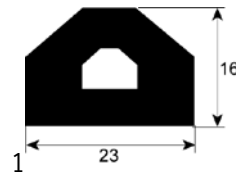

Part No.	900515	Ref. No.	E30100040
description	boiling pan gasket profile 3020 L 3500mm		

sealing washers

fibre gaskets

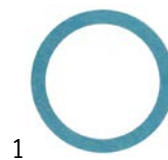

	1		
	Part No.	510406	Ref. No.
			09387 I09387
description	flat gasket fibre ED ø 60mm ID ø 48mm thickness 3mm for thread 1 1/2" Qty 1 pcs		

mechanical components, equipment accessories



springs

torsion springs



Part No.	540855	Ref. No.	08052
description	torsion spring ø 50.8mm wire gauge ø 5.1mm L1 34mm L2 104mm L3 29mm mounting pos. left		



Part No.	540854	Ref. No.	08051
description	torsion spring ø 50.8mm wire gauge ø 5.1mm L1 34mm L2 104mm L3 29mm mounting pos. right		



Part No.	514346	Ref. No.	08008 I08008
description	torsion spring ø 51.5mm wire gauge ø 4.1mm L1 21mm L2 110mm L3 21mm mounting pos. left		



Part No.	514339	Ref. No.	08007 I08007
description	torsion spring ø 51.8mm wire gauge ø 4.1mm L1 20mm L2 106mm L3 20mm mounting pos. right		



Part No.	514526	Ref. No.	08007+08008 32.400.03398-00
description	torsion spring ø 51mm set wire gauge ø 4mm L1 20mm L2 106mm L3 20mm mounting pos. right and left		



Part No.	514352	Ref. No.	08093 I08093
description	torsion spring ø 51mm wire gauge ø 6.5mm L1 28mm L2 101mm L3 28mm mounting pos. left		



Part No.	514351	Ref. No.	08083 I08083
description	torsion spring ø 51mm wire gauge ø 6.5mm L1 28mm L2 101mm L3 28mm mounting pos. right		



Part No.	514350	Ref. No.	08055 I08055
description	torsion spring ø 51mm wire gauge ø 6mm L1 28mm L2 95mm L3 28mm mounting pos. left		



Part No.	514349	Ref. No.	08054 I08054
description	torsion spring ø 51mm wire gauge ø 6mm L1 28mm L2 95mm L3 28mm mounting pos. right		

manometers



Part No.	541579	Ref. No.	10022 39.302.02450
description	manometer ø 52mm pressure range 0 up to 1bar connection marking 0.5 thread 1/4"		

hoses

supply hoses

stainless steel flexi hoses

tap tubes



Part No.	514337	Ref. No.	I07817
description	flex hose SS braid DN8 connections 1/2" - 3/8" L 800mm operating p. 10bar test pressure 32bar burst p. 95bar approval DVGW		

fittings, hose and pipe connectors

fittings

angle pieces



Part No.	514344	Ref. No.	14238 114238
description	angle piece for level glass		

GASTROPARTS.COM

