



**GASTROPARTS**

# Iberital-Macchine

- [EN]** Equipment
- [DE]** Geräte
- [ES]** Aparatos
- [FR]** Équipement
- [IT]** Attrezzature
- [PL]** Urządzenia
- [RU]** Оборудование

✉ [gastroparts@gastroparts.com](mailto:gastroparts@gastroparts.com)

☎ +48 56 657 00 66

📘 [fb.com/gastroparts.global](https://fb.com/gastroparts.global)

**GASTROPARTS.COM**





## heating elements

### heating elements for coffee machine

1 

|                    |   |                 |      |
|--------------------|---|-----------------|------|
| <b>Part No.</b>    | 417258  | <b>Ref. No.</b> | 9938 |
| <b>description</b> | heating element 1800/1960W 230/240V heating circuits 3 mounting $\varnothing$ 38.5mm hole distance 68mm L 184mm W 30mm H 28mm hole $\varnothing$ 11mm length thermostat sleeves 156mm thermostat sleeves $\varnothing$ 6mm number of thermostat sleeves 1 thermostat sleeve centred, adjacent tube $\varnothing$ 8.3mm connection M4 immersion heater 3 hole flange |                 |      |

1 

|                    |  |                 |      |
|--------------------|--|-----------------|------|
| <b>Part No.</b>    | 417496   | <b>Ref. No.</b> | 2415 |
| <b>description</b> | heating element 2600W 220V heating circuits 2 mounting $\varnothing$ 37mm hole distance 52mm L 415mm W 30mm H 58mm L1 25mm L2 50mm L3 340mm H1 25mm H2 28mm hole $\varnothing$ 10mm tube $\varnothing$ 8mm connection male faston 6.3mm immersion heater |                 |      |

1 

|                    |   |                 |      |
|--------------------|---|-----------------|------|
| <b>Part No.</b>    | 417260  | <b>Ref. No.</b> | 9939 |
| <b>description</b> | heating element 2600W 230V heating circuits 2 mounting $\varnothing$ 38.5mm hole distance 58mm L 385mm W 40mm H 46mm L1 25mm L2 45mm L3 315mm H1 26mm H2 20mm hole $\varnothing$ 11mm tube $\varnothing$ 8mm thermostat sleeves $\varnothing$ 6.5mm length thermostat sleeves 191mm thermostat sleeve centred, adjacent number of thermostat sleeves 1 connection M6 immersion heater 3 hole flange |                 |      |

1 

|                    |   |                 |      |
|--------------------|---|-----------------|------|
| <b>Part No.</b>    | 417261  | <b>Ref. No.</b> | 9941 |
| <b>description</b> | heating element 3700W 230V heating circuits 2 mounting $\varnothing$ 38.5mm hole distance 56mm L 580mm W 39mm H 45mm L1 22mm L2 36mm L3 520mm H1 25mm H2 20mm hole $\varnothing$ 11mm tube $\varnothing$ 8mm thermostat sleeves $\varnothing$ 6.5mm length thermostat sleeves 191mm thermostat sleeve centred, adjacent number of thermostat sleeves 1 connection M6 immersion heater 3 hole flange |                 |      |

1 

|                    |  |                 |      |
|--------------------|--|-----------------|------|
| <b>Part No.</b>    | 417259   | <b>Ref. No.</b> | 9940 |
| <b>description</b> | heating element 3800W 230V heating circuits 3 mounting $\varnothing$ 38.5mm hole distance 58mm L 388mm W 33mm H 34mm hole $\varnothing$ 11mm length thermostat sleeves 195mm thermostat sleeves $\varnothing$ 6mm number of thermostat sleeves 1 thermostat sleeve centred, adjacent tube $\varnothing$ 8mm connection M4 immersion heater 3 hole flange |                 |      |

## immersion heating elements

### 3 hole flange $\varnothing$ 35.0mm

1 

|   |  |                 |                   |
|---|--|-----------------|-------------------|
| <b>Part No.</b>   | 416211   | <b>Ref. No.</b> | 23361             |
| <b>description</b>  | heating element 2700W 230V heating circuits 1 mounting $\varnothing$ 35mm L 300mm W 25mm H 24mm tube $\varnothing$ 6.3mm hole distance 44mm hole $\varnothing$ 10mm connection male faston 6.3mm immersion heater 3 hole flange connection length 15mm |                 |                   |
| <b>accessories for</b>  | 416211   |                 |                   |
|  | <b>Part No.</b>  | 507048          | <b>Ref. No.</b> — |
|   | gasket ID $\varnothing$ 30mm silicone thickness 3mm hole $\varnothing$ 10mm hole distance 41mm for heating element warewashing   |                 |                   |

## accessories

### flange gaskets

1 

|                    |  |                 |       |
|--------------------|--|-----------------|-------|
| <b>Part No.</b>    | 528013   | <b>Ref. No.</b> | 11374 |
| <b>description</b> | gasket ID $\varnothing$ 40mm fibre thickness 4mm hole $\varnothing$ 11mm hole distance 57mm for heating element coffee machine parts |                 |       |

1 

|                    |  |                 |      |
|--------------------|--|-----------------|------|
| <b>Part No.</b>    | 528012   | <b>Ref. No.</b> | 6671 |
| <b>description</b> | gasket suitable for VIBIEMME for heating element |                 |      |

## thermostats

### bi-metal thermostats

#### bi-metal thermostats

1 

|   |  |                 |                   |
|---|--|-----------------|-------------------|
| <b>Part No.</b>   | 390450   | <b>Ref. No.</b> | 5299              |
| <b>description</b>  | bi-metal thermostat hole distance mm switch-off temp. 66/57°C NC/NO 2-pole 16A connection F6.3     |                 |                   |
| <b>accessories for</b>  | 390450   |                 |                   |
|  | <b>Part No.</b>  | 505093          | <b>Ref. No.</b> — |
|   | gasket for thermostat ED $\varnothing$ 35mm ID $\varnothing$ 24mm thickness 7mm equiv. no. N503017 |                 |                   |



## control and safety thermostats

EGO

safety thermostats

55.13\_ series



1

|                 |        |                 |       |
|-----------------|--------|-----------------|-------|
| <b>Part No.</b> | 375898 | <b>Ref. No.</b> | 19433 |
|-----------------|--------|-----------------|-------|

|                    |  |
|--------------------|--|
| <b>description</b> | safety thermostat switch-off temp. 140°C 1-pole 16A probe ø 4mm probe L 125mm capillary pipe 900mm capillary pipe isolated 420mm gland nut probe |
|--------------------|--|



1

|                 |        |                 |       |
|-----------------|--------|-----------------|-------|
| <b>Part No.</b> | 390804 | <b>Ref. No.</b> | 43261 |
|-----------------|--------|-----------------|-------|

|                    |   |
|--------------------|---|
| <b>description</b> | safety thermostat switch-off temp. 340°C 1-pole 1NC 16A probe ø 3mm probe L 160mm capillary pipe 870mm capillary pipe isolated 600mm gland nut probe connection male faston 6.3mm |
|--------------------|---|

55.32\_ series



1

|                 |        |                 |                |
|-----------------|--------|-----------------|----------------|
| <b>Part No.</b> | 390324 | <b>Ref. No.</b> | 10028<br>16508 |
|-----------------|--------|-----------------|----------------|

|                    |   |
|--------------------|---|
| <b>description</b> | safety thermostat switch-off temp. 169°C 3-pole 3NC 20A probe ø 4mm probe L 128mm capillary pipe 890mm capillary pipe isolated 210/210mm gland nut probe SS |
|--------------------|---|

## switches and momentary switches

## rocker/momentary rocker switches

30x22mm



1

|                 |        |                 |      |
|-----------------|--------|-----------------|------|
| <b>Part No.</b> | 301002 | <b>Ref. No.</b> | 6952 |
|-----------------|--------|-----------------|------|

|                    |  |
|--------------------|--|
| <b>description</b> | rocker switch mounting measurements 30x22mm orange 2NO 250V 16A illuminated 0-I connection male faston 6.3mm ambient temperature max. 85/125°C protection IP65 |
|--------------------|--|

|                        |        |
|------------------------|--------|
| <b>accessories for</b> | 301002 |
|------------------------|--------|



|                    |  |                 |   |
|--------------------|--|-----------------|---|
| <b>Part No.</b>    | 301036   | <b>Ref. No.</b> | — |
| <b>description</b> | protective cover internal size 30x22mm for rocker switch mounting measurementsmm |                 |   |



1

|                 |        |                 |      |
|-----------------|--------|-----------------|------|
| <b>Part No.</b> | 301060 | <b>Ref. No.</b> | 5828 |
|-----------------|--------|-----------------|------|

|                    |   |
|--------------------|---|
| <b>description</b> | rocker switch mounting measurements 30x22mm red 2NO 250V 16A illuminated connection male faston 6.3mm ambient temperature max. 125/55°C protection IP40 |
|--------------------|---|

## push/momentary push switches

19x13mm



1

|                 |        |                 |       |
|-----------------|--------|-----------------|-------|
| <b>Part No.</b> | 347377 | <b>Ref. No.</b> | 19078 |
|-----------------|--------|-----------------|-------|

|                    |   |
|--------------------|---|
| <b>description</b> | momentary push switch mounting measurements 19x13mm red 2NO 250V 16A ambient temperature max. 125°C protection IP40 |
|--------------------|---|

ø25mm



1

|                 |                     |                 |      |
|-----------------|---------------------|-----------------|------|
| <b>Part No.</b> | 345151 <sup>1</sup> | <b>Ref. No.</b> | 1660 |
|-----------------|---------------------|-----------------|------|

|                    |  |
|--------------------|--|
| <b>description</b> | push switch mounting ø 25mm orange 2NO 250V 16A illuminated connection male faston 6.3mm ambient temperature max. 85°C protection IP40 |
|--------------------|--|

<sup>1</sup>illuminated

## miscellaneous



1

|                 |        |                 |      |
|-----------------|--------|-----------------|------|
| <b>Part No.</b> | 347317 | <b>Ref. No.</b> | 9420 |
|-----------------|--------|-----------------|------|

|                    |   |
|--------------------|---|
| <b>description</b> | microswitch mounting measurements 12x15mm black 1NO 240V 4A connection soldering connection ambient temperature max. 85°C protection IP40 |
|--------------------|---|



microswitches

roller actuated

roller 90°



|                    |   |                 |     |
|--------------------|---|-----------------|-----|
| 1                  |   |                 |     |
| <b>Part No.</b>    | 345104  | <b>Ref. No.</b> | 399 |
| <b>description</b> | microswitch with roller plunger 250V 16A 1CO connection male faston 6.3mm L 24mm ambient temperature max. 125°C thread L 12mm thread M10x0.75 mounting distance 22mm actuating force: 280g type EF83161.1 |                 |     |

cam switches

on/off



|                    |   |                 |       |
|--------------------|---|-----------------|-------|
| 1                  |   |                 |       |
| <b>Part No.</b>    | 300021  | <b>Ref. No.</b> | 40704 |
| <b>description</b> | cam switch 4 operating positions 4NO sequence 0-1-0-1 16A shaft ø 6x4.6mm shaft L 23mm connection screw ceramic |                 |       |

rotary switches

GIOVENZANA

rotary switches



|                    |  |                 |      |
|--------------------|--|-----------------|------|
| 1                  |  |                 |      |
| <b>Part No.</b>    | 347975   | <b>Ref. No.</b> | 9177 |
| <b>description</b> | rotary switch 3 0-1-2 sets of contacts 3 type P106 690V 20A shaft ø 5x5mm shaft L 15mm shaft square connection screw |                 |      |

GOTTAK



|                    |  |                 |       |
|--------------------|--|-----------------|-------|
| 1                  |  |                 |       |
| <b>Part No.</b>    | 347380   | <b>Ref. No.</b> | 11255 |
| <b>description</b> | rotary switch 3 0-1-2 sets of contacts 2 400V 16A shaft ø 6x4.6mm shaft L 22mm shaft oval connection male faston 6.3mm |                 |       |

|                    |   |                 |      |
|--------------------|---|-----------------|------|
| 1                  |   |                 |      |
| <b>Part No.</b>    | 345148  | <b>Ref. No.</b> | 2877 |
| <b>description</b> | rotary switch 3 0-1-2 sets of contacts 6 type 4RH 400V 10A shaft ø 4.8x6mm shaft L 21mm shaft oval connection male faston 6.3mm |                 |      |

|                    |  |                 |       |
|--------------------|--|-----------------|-------|
| 1                  |  |                 |       |
| <b>Part No.</b>    | 347378   | <b>Ref. No.</b> | 24989 |
| <b>description</b> | rotary switch 4 0-1-2-3 sets of contacts 4 400V 16A shaft ø 6x4.6mm shaft L 22mm shaft oval connection male faston 6.3mm |                 |       |

|                    |  |                 |       |
|--------------------|--|-----------------|-------|
| <b>TELERGON</b>    |  |                 |       |
| 1                  |  |                 |       |
| <b>Part No.</b>    | 347693   | <b>Ref. No.</b> | 43294 |
| <b>description</b> | rotary switch 2 0-1 sets of contacts 1 type T-0002000011E1N1 300V 20A shaft ø 5x5mm shaft L 15mm shaft square with knob connection screw clamp |                 |       |

|                    |  |                 |      |
|--------------------|--|-----------------|------|
| 1                  |  |                 |      |
| <b>Part No.</b>    | 347479   | <b>Ref. No.</b> | 1430 |
| <b>description</b> | rotary switch 3 0-1-2 sets of contacts 6 type T-0002021589 400V 20A shaft ø 5x5mm shaft L 15mm connection screw TELERGON |                 |      |

lamps

indicator lights

indicator lights (complete)

ø10mm

with plug-in socket

|                    |  |                 |       |
|--------------------|--|-----------------|-------|
| 1                  |  |                 |       |
| <b>Part No.</b>    | 359139   | <b>Ref. No.</b> | 19457 |
| <b>description</b> | indicator light ø 10mm green 230V connection male faston 6.3mm Qty 1 pcs |                 |       |



|   |  |                 |       |
|---|--|-----------------|-------|
|  |  |                 |       |
| 1   |  |                 |       |
| <b>Part No.</b>   | 359138   | <b>Ref. No.</b> | 19458 |
| <b>description</b>  | indicator light ø 10mm red 230V connection male faston 6.3mm Qty 1 pcs |                 |       |

ø13mm

with screw socket



|   |  |                 |       |
|---|--|-----------------|-------|
|  |  |                 |       |
| 1   |  |                 |       |
| <b>Part No.</b>   | 357125   | <b>Ref. No.</b> | 43040 |
| <b>description</b>  | indicator light ø 13mm red 400V connection screw clamp |                 |       |

miscellaneous



|   |   |                 |       |
|---|---|-----------------|-------|
|  |   |                 |       |
| 1   |   |                 |       |
| <b>Part No.</b>   | 357124  | <b>Ref. No.</b> | 43292 |
| <b>description</b>  | indicator light green/red 230V connection screw |                 |       |



## timers

## programme timers

|   |  |                 |                   |
|---|--|-----------------|-------------------|
|  |  |                 |                   |
| 1   |  |                 |                   |
| <b>Part No.</b>   | 360048   | <b>Ref. No.</b> | 13588             |
| <b>description</b>  | timer CDC 4904DV/4905DV engines 2 chambers 5 operation time 4s / 180s 230V shaft ømm shaft Lmm motor type M48L ATS |                 |                   |
| <b>spare parts for</b>  | 360048   |                 |                   |
|  | <b>Part No.</b>  | 360083          | <b>Ref. No.</b> — |
|   | motor CDC pinion ø 4.9mm teeth 10 230V turn direction left motor ø 47mm H 19.3mm motor type M48L ATS for timer     |                 |                   |

|   |  |                 |       |
|---|--|-----------------|-------|
|  |  |                 |       |
| 1   |  |                 |       |
| <b>Part No.</b>   | 361355   | <b>Ref. No.</b> | 14343 |
| <b>description</b>  | timer CDC 7804DV engines 2 chambers 4 operation time 6s / 3min 230V shaft ømm shaft Lmm motor type M37RN/M37LN |                 |       |

|  |   |                 |                   |
|--|---|-----------------|-------------------|
|  |   |                 |                   |
| 1  |   |                 |                   |
| <b>Part No.</b>  | 360011  | <b>Ref. No.</b> | 6363              |
| <b>description</b>   | timer CEM HH3M16 engines 1 chambers 3 operation time 120s 230V manuf. no. HH3M16 / 120225 motor type UDS40NE1RNZ165 |                 |                   |
| <b>spare parts for</b>   | 360011  |                 |                   |
|   | <b>Part No.</b>   | 360112          | <b>Ref. No.</b> — |
|  | motor SAIA pinion ø 4mm teeth 12 230V turn direction right motor ø 48mm motor type UDS11NE1RHZ for timer            |                 |                   |

|   |  |                 |                   |
|---|--|-----------------|-------------------|
|   |  |                 |                   |
| 1   |  |                 |                   |
| <b>Part No.</b>   | 360271   | <b>Ref. No.</b> | 14472             |
| <b>description</b>  | timer FIBER P25 engines 2 chambers 5 operation time 6s / 2min 230V shaft ømm shaft Lmm manuf. no. P255J05JDN7 motor type M51BJOR6400 / M51BJOL6400                       |                 |                   |
| <b>spare parts for</b>  | 360271   |                 |                   |
|  | <b>Part No.</b>  | 360673          | <b>Ref. No.</b> — |
|   | motor kit pinion ø 6.8mm teeth 15 230V voltage AC 50/60Hz turn direction clockwise motor ø 48mm H 18.5mm motor type UDS-40NE1RNZ165 cable length 150mm with holder       |                 |                   |
|  | <b>Part No.</b>  | 360674          | <b>Ref. No.</b> — |
|   | motor kit pinion ø 6.8mm teeth 15 230V voltage AC 50/60Hz turn direction counterclockwise motor ø 48mm H 18.5mm motor type UDS40NE1RNZ165 cable length 150mm with holder |                 |                   |

## mechanical timers

|  |  |                 |                   |
|--|--|-----------------|-------------------|
|  |  |                 |                   |
| 1  |  |                 |                   |
| <b>Part No.</b>  | 350176   | <b>Ref. No.</b> | 10560             |
| <b>description</b>   | timer C20 2-pole operation time 5min 2NO at 250V 16A permanent position no shaft ø 6x4.6mm shaft 6x4.6mm shaft L 20mm mounting distance 28mm |                 |                   |
| <b>accessories for</b>   | 350176   |                 |                   |
|   | <b>Part No.</b>  | 110366          | <b>Ref. No.</b> — |
|  | knob switch zero mark t.max.°C°C ø 44mm shaft ø 6x4.6mm shaft flat upper black   |                 |                   |
|   | <b>Part No.</b>  | 112138          | <b>Ref. No.</b> — |
|  | dial plate graduation 5min permanent position no rotation 0-290° ø 60mm  |                 |                   |



contactors

LS Industrial Systems

power contactors



1

|                    |  |                 |       |
|--------------------|--|-----------------|-------|
| <b>Part No.</b>    | 380922   | <b>Ref. No.</b> | 19036 |
| <b>description</b> | power contactor resistive load 20A 230VAC (AC3/400V) 5A/2.2kW main contacts 3NO auxiliary contacts 1NO connection screw connection type GMC-6M |                 |       |



1

|                    |  |                 |                     |
|--------------------|--|-----------------|---------------------|
| <b>Part No.</b>    | 380923   | <b>Ref. No.</b> | 19428 (old version) |
| <b>description</b> | power contactor resistive load 25A 230VAC (AC3/400V) 18A/7.5kW main contacts 4NO connection screw connection type GMC-18/4 |                 |                     |



1

|                    |   |                 |                |
|--------------------|---|-----------------|----------------|
| <b>Part No.</b>    | 380924  | <b>Ref. No.</b> | 13353<br>19428 |
| <b>description</b> | power contactor resistive load 32A 230VAC (AC3/400V) 22A/11kW main contacts 4NO connection screw connection type UKC1-22/KR4S |                 |                |

GENERAL ELECTRIC (AEG)

power contactors



1

|                    |   |                 |      |
|--------------------|---|-----------------|------|
| <b>Part No.</b>    | 380846  | <b>Ref. No.</b> | 8736 |
| <b>description</b> | contactor resistive load 16A 230VAC (AC3/400V) 9A/4kW main contacts 3NO auxiliary contacts 1NC connection male faston 6.3mm type AEG LS05 01A type GE MC1A 301A |                 |      |

ALLEN BRADLEY

power contactors



1

|                    |   |                 |      |
|--------------------|---|-----------------|------|
| <b>Part No.</b>    | 380458  | <b>Ref. No.</b> | 8365 |
| <b>description</b> | power contactor resistive load 20A 230VAC (AC3/400V) 9A/4kW main contacts 3NO auxiliary contacts 1NO connection screw connection type 100-K09KF10 |                 |      |

solid state relays

CELDUC



1

|                    |  |                 |       |
|--------------------|--|-----------------|-------|
| <b>Part No.</b>    | 400521   | <b>Ref. No.</b> | 19030 |
| <b>description</b> | solid state relay CELDUC 2 phase 50A 400V 10-30VDC L 58mm W 45mm screw type SCB965600 10-30VDC |                 |       |

relays

power relays

with DIN rail mounting

lateral



1

|                    |   |                 |      |
|--------------------|---|-----------------|------|
| <b>Part No.</b>    | 380379  | <b>Ref. No.</b> | 6690 |
| <b>description</b> | power relays SCHRACK 230VAC 25A 2CO connection male faston 6.3mm DIN rail manuf. no. RM809730 |                 |      |



## level relays

## GICAR



1

|                    |   |                 |      |
|--------------------|---|-----------------|------|
| <b>Part No.</b>    | 402103  | <b>Ref. No.</b> | 9625 |
| <b>description</b> | level controller 230/240V voltage AC 50/60Hz connection F6.3 type NRL30/1E-2C/F |                 |      |



1

|                    |   |                 |       |
|--------------------|---|-----------------|-------|
| <b>Part No.</b>    | 528636  | <b>Ref. No.</b> | 13391 |
| <b>description</b> | level controller 230V voltage AC 50/60Hz 16/5A connection F6.3 type RL30 MICRO ST |                 |       |



1

|                    |  |                 |       |
|--------------------|--|-----------------|-------|
| <b>Part No.</b>    | 402623   | <b>Ref. No.</b> | 21475 |
| <b>description</b> | level controller 230V voltage AC 50/60Hz type 30µZ 3L S.T. |                 |       |

## miscellaneous



1

|                    |                  |                 |      |
|--------------------|------------------|-----------------|------|
| <b>Part No.</b>    | 400264           | <b>Ref. No.</b> | 7145 |
| <b>description</b> | level relay 230V |                 |      |

## probes

## producer-specific probes

## probes



1

|                    |   |                 |       |
|--------------------|---|-----------------|-------|
| <b>Part No.</b>    | 525376  | <b>Ref. No.</b> | 13375 |
| <b>description</b> | temperature probe NTC cable PVC probe -40 up to +110°C cable -10 up to 100°C connection plug thread 1/4" probe ø8x20mm cable length 0.37m |                 |       |

## keypads

## front foils



1

|                    |   |                 |       |
|--------------------|---|-----------------|-------|
| <b>Part No.</b>    | 525373  | <b>Ref. No.</b> | 19441 |
| <b>description</b> | keypad foil black/silver suitable for IBERITAL L 27mm W 103mm buttons 5 |                 |       |



1

|                    |  |                 |       |
|--------------------|--|-----------------|-------|
| <b>Part No.</b>    | 525374   | <b>Ref. No.</b> | 19092 |
| <b>description</b> | keypad foil black/yellow suitable for FAEMA L 107mm W 51mm buttons 5 |                 |       |



1

|                    |   |                 |       |
|--------------------|---|-----------------|-------|
| <b>Part No.</b>    | 525212  | <b>Ref. No.</b> | 19025 |
| <b>description</b> | keypad foil silver/black suitable for IBERITAL L 103mm W 27mm buttons 5 |                 |       |

## membrane keypads



1

|                    |  |                 |      |
|--------------------|--|-----------------|------|
| <b>Part No.</b>    | 400509   | <b>Ref. No.</b> | 9998 |
| <b>description</b> | membrane keypad coffee machine IBERITAL L 103mm W 27mm |                 |      |



1

|                    |  |                 |       |
|--------------------|--|-----------------|-------|
| <b>Part No.</b>    | 401408   | <b>Ref. No.</b> | 21934 |
| <b>description</b> | membrane keypad coffee machine parts buttons 6 suitable for FAEMA L 176mm W 49mm |                 |       |



1

|                    |  |                 |       |
|--------------------|--|-----------------|-------|
| <b>Part No.</b>    | 402635   | <b>Ref. No.</b> | 11641 |
| <b>description</b> | membrane keypad suitable for IBERITAL L 110mm W 30mm |                 |       |



|                    |  |                 |       |
|--------------------|--|-----------------|-------|
|                    |  |                 |       |
| 1                  |  |                 |       |
| <b>Part No.</b>    | 402634   | <b>Ref. No.</b> | 19093 |
| <b>description</b> | membrane keypad suitable for IBERITAL L 110mm W 55mm |                 |       |

keypad units

|                    |                       |                 |                |
|--------------------|-----------------------|-----------------|----------------|
|                    |                       |                 |                |
| 1                  |                       |                 |                |
| <b>Part No.</b>    | 400226                | <b>Ref. No.</b> | 21476<br>21960 |
| <b>description</b> | keypad unit buttons 5 |                 |                |

|                    |   |                 |       |
|--------------------|---|-----------------|-------|
|                    |   |                 |       |
| 1                  |   |                 |       |
| <b>Part No.</b>    | 402628  | <b>Ref. No.</b> | 11361 |
| <b>description</b> | keypad unit buttons 5 black type TH SMT 1GR+RL lighting LED 230V L 120mm W 50mm |                 |       |

|                    |  |                 |       |
|--------------------|--|-----------------|-------|
|                    |  |                 |       |
| 1                  |  |                 |       |
| <b>Part No.</b>    | 402626   | <b>Ref. No.</b> | 19424 |
| <b>description</b> | keypad unit buttons 5 black/silver type 1d5e GRCZ NKP S10 lighting LED 230V L 117mm W 46mm |                 |       |

|                    |   |                 |       |
|--------------------|---|-----------------|-------|
|                    |   |                 |       |
| 1                  |   |                 |       |
| <b>Part No.</b>    | 402627  | <b>Ref. No.</b> | 13349 |
| <b>description</b> | keypad unit buttons 5 black/silver type 1d5e GRCZ NKP S10 lighting LED 230V L 117mm W 46mm with jumpers |                 |       |

|                    |   |                 |      |
|--------------------|---|-----------------|------|
|                    |   |                 |      |
| 1                  |   |                 |      |
| <b>Part No.</b>    | 402624  | <b>Ref. No.</b> | 9997 |
| <b>description</b> | keypad unit buttons 5 black/silver type TH SMT 1GR+TEA 230V |                 |      |

|                    |  |                 |       |
|--------------------|--|-----------------|-------|
|                    |  |                 |       |
| 1                  |  |                 |       |
| <b>Part No.</b>    | 402636   | <b>Ref. No.</b> | 19042 |
| <b>description</b> | keypad unit buttons 5 black/white type TH SMT 1GR+RL 230V L 120mm W 50mm with jumper |                 |       |

|                    |  |                 |       |
|--------------------|--|-----------------|-------|
|                    |  |                 |       |
| 1                  |  |                 |       |
| <b>Part No.</b>    | 402632   | <b>Ref. No.</b> | 21451 |
| <b>description</b> | keypad unit buttons 5 black/yellow type 1d5e GRCZ NKP S10 no c/m 230V L 120mm W 50mm with jumper |                 |       |

|                    |  |                 |       |
|--------------------|--|-----------------|-------|
|                    |  |                 |       |
| 1                  |  |                 |       |
| <b>Part No.</b>    | 402631   | <b>Ref. No.</b> | 21981 |
| <b>description</b> | keypad unit buttons 5 black/yellow type 1d5e GRCZ NKP S10 no c/m 230V L 132mm W 64mm |                 |       |

|                    |                                     |                 |       |
|--------------------|-------------------------------------|-----------------|-------|
|                    |                                     |                 |       |
| 1                  |                                     |                 |       |
| <b>Part No.</b>    | 400441                              | <b>Ref. No.</b> | 11440 |
| <b>description</b> | keypad unit buttons 5 L 91mm W 51mm |                 |       |

|                    |  |                 |       |
|--------------------|--|-----------------|-------|
|                    |  |                 |       |
| 1                  |  |                 |       |
| <b>Part No.</b>    | 402630   | <b>Ref. No.</b> | 19439 |
| <b>description</b> | keypad unit buttons 5 type 1d5e GRCZ NKP S10 230V L 120mm W 50mm with jumper |                 |       |

|                    |   |                 |       |
|--------------------|---|-----------------|-------|
|                    |   |                 |       |
| 1                  |   |                 |       |
| <b>Part No.</b>    | 402629  | <b>Ref. No.</b> | 13381 |
| <b>description</b> | keypad unit buttons 5 type 1d5e GRCZ NKP S10 lighting LED 230V L 120mm W 50mm |                 |       |





|   |   |                 |      |
|---|---|-----------------|------|
|  |   |                 |      |
| 1   |   |                 |      |
| <b>Part No.</b>   | 400354  | <b>Ref. No.</b> | 7633 |
| <b>description</b>  | keypad unit coffee machine AIRY/ATLAS/COMBI NOVA/JUNIOR buttons 5 |                 |      |

|   |   |                 |       |
|---|---|-----------------|-------|
|  |   |                 |       |
| 1   |   |                 |       |
| <b>Part No.</b>   | 402633  | <b>Ref. No.</b> | 21769 |
| <b>description</b>  | keypad unit temperature controller type CONTROL d „SSR HEATING“ C/L |                 |       |

## solenoïd valves

### solenoïd valves (water)

metal

M&amp;M

2-way



D267 series





|   |  |                 |       |
|---|--|-----------------|-------|
|  |  |                 |       |
| 1   |  |                 |       |
| <b>Part No.</b>   | 370598   | <b>Ref. No.</b> | 19072 |
| <b>description</b>  | solenoïd valve brass 2-ways 230VAC inlet 1/4" outlet 1/4" connection 1/4" slide-on receptacle DIN -10 up to 180°C M&M type series D267 coil type 7701 membranes PTFE (steam) p max 9bar p min 0bar voltage 50/60 |                 |       |

PARKER

3-way

VE-128 series

|   |   |                 |                   |
|---|---|-----------------|-------------------|
|  |   |                 |                   |
| 1   |   |                 |                   |
| <b>Part No.</b>   | 370057  | <b>Ref. No.</b> | 8259              |
| <b>description</b>  | solenoïd valve 3-ways 230VAC body outer cone DN 1.2mm slide-on receptacle DIN -20° up to 140°C PARKER type series VE-128 coil type ZB09 membranes ruby p max 10bar brass flange 32x32mm |                 |                   |
| <b>spare parts for</b>  | 370057  |                 |                   |
|  | <b>Part No.</b>   | 370062          | <b>Ref. No.</b> — |
|   | solenoïd valve body PARKER 3-ways outer cone  |                 |                   |

|   |   |        |                   |
|---|---|--------|-------------------|
| <b>spare parts for</b>  | 370057  |        |                   |
|  | <b>Part No.</b>   | 371029 | <b>Ref. No.</b> — |
|   | solenoïd coil PARKER 230VAC 9VA coil type ZB09 seat ø 14mm H 33mm W 34mm D 43mm |        |                   |
| <b>accessories for</b>  | 370057  |        |                   |
|  | <b>Part No.</b>   | 371090 | <b>Ref. No.</b> — |
|   | power socket plug type DIN 43650A screw   |        |                   |
|  | <b>Part No.</b>   | 371095 | <b>Ref. No.</b> — |
|   | O-ring Viton thickness 1.78mm ID ø 6.07mm Qty 1 pcs                             |        |                   |
|  | <b>Part No.</b>   | 371100 | <b>Ref. No.</b> — |
|   | O-ring silicone thickness 1.78mm ID ø 6.07mm Qty 1 pcs                          |        |                   |

## pressure switches

### for coffee machines

ø 38mm

|   |  |                 |       |
|---|--|-----------------|-------|
|  |  |                 |       |
| 1   |  |                 |       |
| <b>Part No.</b>   | 541104   | <b>Ref. No.</b> | 21463 |
| <b>description</b>  | pressure control ø 38mm pressure range 0.2-1.2bar 10A 250V connection male faston 6.3mm 1CO pressure connection 1/4" |                 |       |

## electrodes

|  |   |                 |       |
|--|---|-----------------|-------|
|  |   |                 |       |
| 1  |   |                 |       |
| <b>Part No.</b>  | 401363  | <b>Ref. No.</b> | 21480 |
| <b>description</b>   | level electrode 1/4" total length 110mm probe L 85mm insulated probe length 26mm connection male faston 6.3mm stainless steel ø 2.5mm |                 |       |

|  |  |                 |      |
|--|--|-----------------|------|
|  |  |                 |      |
| 1  |  |                 |      |
| <b>Part No.</b>  | 401157   | <b>Ref. No.</b> | 5277 |
| <b>description</b>   | level electrode 1/4" total length 150mm probe L 122mm insulated probe length 26mm connection male faston 6.3mm stainless steel ø 2.5mm |                 |      |

|  |  |                 |       |
|--|--|-----------------|-------|
|  |  |                 |       |
| 1  |  |                 |       |
| <b>Part No.</b>  | 400404   | <b>Ref. No.</b> | 21479 |
| <b>description</b>   | level electrode 1/4" total length 240mm probe L 216mm insulated probe length 209mm PTFE insulated connection angled, male faston 6.3mm stainless steel ø 2.5mm |                 |       |



## flow meters and flow sensors

### flow meters

GICAR



1

|                 |        |                 |       |
|-----------------|--------|-----------------|-------|
| <b>Part No.</b> | 541750 | <b>Ref. No.</b> | 21456 |
|-----------------|--------|-----------------|-------|

|                    |  |
|--------------------|--|
| <b>description</b> | flow meter hose ø 7mm plastic approval NSF |
|--------------------|--|

## motors

### motors

for ice-cube maker

complete



1

|                 |        |                 |       |
|-----------------|--------|-----------------|-------|
| <b>Part No.</b> | 500793 | <b>Ref. No.</b> | 23735 |
|-----------------|--------|-----------------|-------|

|                    |  |
|--------------------|--|
| <b>description</b> | motor with belt pulley 120W 230V 50/60Hz 1 phase shaft ø 10mm 1390/1600rpm type RM63/50 ø 90mm H 160mm REBO 0.12kW |
|--------------------|--|

|                        |        |
|------------------------|--------|
| <b>spare parts for</b> | 500793 |
|------------------------|--------|

|                    |   |                 |   |
|--------------------|---|-----------------|---|
| <b>Part No.</b>    | 695279  | <b>Ref. No.</b> | — |
| <b>description</b> | round belt pulley disc ø 49mm single shaft intake ø 10mm groove depth 5mm disc width 12mm groove width 10mm overall width 19mm shaft ø 18mm |                 |   |

## pumps

### wash and rinse pumps

ALBA (C&A)

pumps



1

|                 |        |                 |       |
|-----------------|--------|-----------------|-------|
| <b>Part No.</b> | 500299 | <b>Ref. No.</b> | 17240 |
|-----------------|--------|-----------------|-------|

|                    |   |
|--------------------|---|
| <b>description</b> | pump inlet ø 28mm outlet ø 28mm type C903SX 230V 50Hz 1 phase 0.11kW 0.15HP L 200mm rotation direction right capacitor 6.3µF ALBA PUMPS (C&A) |
|--------------------|---|

|                        |        |
|------------------------|--------|
| <b>spare parts for</b> | 500299 |
|------------------------|--------|

|                    |  |                 |   |
|--------------------|--|-----------------|---|
| <b>Part No.</b>    | 365012   | <b>Ref. No.</b> | — |
| <b>description</b> | operating capacitor capacity 6.3µF 450V tolerance 5% 50Hz ambient temperature max. -25 to +85°C ø 30mm L 61mm M8 plastic connection male faston 6.3mm protection |                 |   |

|                    |   |                 |   |
|--------------------|---|-----------------|---|
| <b>Part No.</b>    | 510692  | <b>Ref. No.</b> | — |
| <b>description</b> | mechanical shaft seal for shaft ø 11mm slide ring ext. ø 24mm slide ring H 13mm counter ring mounting ø 26mm height counter ring 8mm counter ring int. ø 14mm |                 |   |





|                    |   |                 |   |
|--------------------|---|-----------------|---|
| <b>Part No.</b>    | 521222  | <b>Ref. No.</b> | — |
| <b>description</b> | impellor ø 72mm H 19mm thread M7L shaft ø 11mm shaft length 29mm blades 3 |                 |   |

|                    |  |                 |   |
|--------------------|--|-----------------|---|
| <b>Part No.</b>    | 521518   | <b>Ref. No.</b> | — |
| <b>description</b> | pump cover ALBA PUMPS (C&A) inlet ø 28mm outlet ø 28mm turn direction right ø 93mm ID ø 76mm inner height 31mm |                 |   |

|                    |   |                 |   |
|--------------------|---|-----------------|---|
| <b>Part No.</b>    | 532490  | <b>Ref. No.</b> | — |
| <b>description</b> | O-ring EPDM thickness 2.62mm ID ø 72.69mm Qty 1 pcs |                 |   |



1





|   |  |                 |            |
|---|--|-----------------|------------|
| <b>Part No.</b>   | 500938   | <b>Ref. No.</b> | 4603       |
| <b>description</b>  | pump inlet $\varnothing$ 30mm outlet $\varnothing$ 30mm type IM1629030 230V 50Hz 1 phase 0.22kW 0.3HP L 175mm rotation direction right capacitor 10 $\mu$ F auxiliary pressure connection 10mm supporting pressure open ALBA PUMPS (C&A)             |                 |            |
| <b>spare parts for</b>  | 500938   |                 |            |
|    | <b>Part No.</b>  | 507065          | Ref. No. — |
|   | pump cover   |                 |            |
|   | <b>Part No.</b>  | 509018          | Ref. No. — |
|   | O-ring EPDM thickness 3.53mm ID $\varnothing$ 107.5mm Qty 1 pcs  |                 |            |
|  | <b>Part No.</b>  | 509028          | Ref. No. — |
|   | impeller $\varnothing$ 87mm H 21mm rotation direction right thread M7L shaft $\varnothing$ 12mm  |                 |            |
|  | <b>Part No.</b>  | 510693          | Ref. No. — |
|   | mechanical shaft seal for shaft $\varnothing$ 12mm slide ring ext. $\varnothing$ 24mm slide ring H 15.5mm slide ring int. $\varnothing$ 11mm counter ring mounting $\varnothing$ 24mm height counter ring 8mm counter ring int. $\varnothing$ 13.5mm |                 |            |
| <b>accessories for</b>  | 500938   |                 |            |
|  | <b>Part No.</b>  | 365014          | Ref. No. — |
|   | operating capacitor capacity 12.5 $\mu$ F 450V tolerance 5%Hz ambient temperature max. -25 to +85°C $\varnothing$ 35mm L 70mm M8 plastic connection male faston 6.3mm 45S.C3DS.12.5 protection   |                 |            |

FIR

pumps



1

|   |  |                 |            |
|---|--|-----------------|------------|
| <b>Part No.</b>   | 500261   | <b>Ref. No.</b> | 23481      |
| <b>description</b>  | pump inlet $\varnothing$ 30mm outlet $\varnothing$ 30mm type 1267.1405 230V 50Hz 1 phase 0.18kW 0.25HP L 180mm rotation direction right capacitor 10 $\mu$ F FIR                 |                 |            |
| <b>spare parts for</b>  | 500261   |                 |            |
|    | <b>Part No.</b>  | 365015          | Ref. No. — |
|   | operating capacitor capacity 10 $\mu$ F 400V tolerance 5%Hz ambient temperature max. -25 to +85°C $\varnothing$ 35.5mm L 59mm M8 plastic connection male faston 6.3mm protection |                 |            |
|    | <b>Part No.</b>  | 510605          | Ref. No. — |
|   | impellor $\varnothing$ 80mm H 21mm M7L   |                 |            |
|  | <b>Part No.</b>  | 510702          | Ref. No. — |
|   | mechanical shaft seal height counter ring 5.5mm ID $\varnothing$ 12mm  |                 |            |
|  | <b>Part No.</b>  | 521571          | Ref. No. — |
|   | pump cover FIR inlet $\varnothing$ 30mm outlet $\varnothing$ 30mm turn direction right $\varnothing$ 128mm ID $\varnothing$ 100mm inner height 21mm                              |                 |            |
|  | <b>Part No.</b>  | 521701          | Ref. No. — |
|   | pump cover gasket  |                 |            |





LGB





|   |                        |  |                 |       |
|---|------------------------|--|-----------------|-------|
| 1   | <b>Part No.</b>        | 500153   | <b>Ref. No.</b> | 14812 |
|   | <b>description</b>     | pump inlet ø outlet ø type W180SX 230V 50Hz 1 phase 0.19kW 0.26HP L 220mm rotation direction right capacitor 5µF LGB   |                 |       |
|   | <b>spare parts for</b> | 500153   |                 |       |
|    | <b>Part No.</b>        | 365017   | <b>Ref. No.</b> | —     |
|   | <b>description</b>     | operating capacitor capacity 5µF 450V tolerance 5% 50/60Hz ambient temperature max. -25 to +85°C ø 28mm L 54mm M8 plastic connection male faston 6.3mm 16.10.08 protection |                 |       |
|   | <b>Part No.</b>        | 510703   | <b>Ref. No.</b> | —     |
|   | <b>description</b>     | mechanical shaft seal for shaft ø 13mm slide ring H 13mm height counter ring 5.5mm ED ø 26mm   |                 |       |
|  | <b>Part No.</b>        | 513267   | <b>Ref. No.</b> | —     |
|   | <b>description</b>     | end cap for wash pump suitable for pump casing   |                 |       |
|  | <b>Part No.</b>        | 518177   | <b>Ref. No.</b> | —     |
|   | <b>description</b>     | drain unit thread 3/4" ID ø 35mm hose ø 24mm   |                 |       |
|  | <b>Part No.</b>        | 518204   | <b>Ref. No.</b> | —     |
|   | <b>description</b>     | screw connection for filter ø 67mm   |                 |       |
|  | <b>Part No.</b>        | 518205   | <b>Ref. No.</b> | —     |
|   | <b>description</b>     | flat gasket rubber ED ø 61mm ID ø 47mm thickness 2mm Qty 1 pcs   |                 |       |
|  | <b>Part No.</b>        | 521147   | <b>Ref. No.</b> | —     |
|   | <b>description</b>     | flange   |                 |       |
|  | <b>Part No.</b>        | 521221   | <b>Ref. No.</b> | —     |
|   | <b>description</b>     | impellor ø 67mm H 16mm rotation direction right thread M7L shaft ø 13mm shaft length 12mm blades 8   |                 |       |
|  | <b>Part No.</b>        | 528800   | <b>Ref. No.</b> | —     |
|   | <b>description</b>     | O-ring EPDM thickness 2.62mm ID ø 75.87mm Qty 1 pcs  |                 |       |

vibration pumps

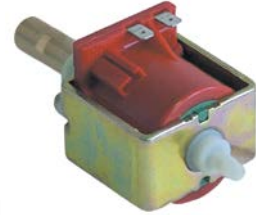

|                    |  |                 |      |
|--------------------|--|-----------------|------|
| 1                  |  |                 |      |
| <b>Part No.</b>    | 520250   | <b>Ref. No.</b> | 4112 |
| <b>description</b> | by-pass thread 1/8" IT T2: M12x1 IG  |                 |      |





|                    |   |                 |      |
|--------------------|---|-----------------|------|
| 1                  |                 |                 |      |
| <b>Part No.</b>    | 499054  | <b>Ref. No.</b> | 6072 |
| <b>description</b> | vibration pump type 1108PAALM3N 220/240V 70W 50Hz inlet ø 1/8" outlet ø 1/8" FLUID-O-TECH L 129mm |                 |      |

|   |   |   |                 |   |
|---|---|---|-----------------|---|
| 1   |                |   |                 |   |
| <b>Part No.</b>   | 500124  | <b>Ref. No.</b>   | 20021           |   |
| <b>description</b>  | vibration pump type EX 5 230V 48W 50/60Hz inlet ø 6 outlet ø 1/8" IT flat seal ULKA brass L 123mm |   |                 |   |
| <b>accessories for</b>  | 500124  |   |                 |   |
|  | <b>Part No.</b>   | 520152  | <b>Ref. No.</b> | — |
|   | <b>description</b>  | hose connector Santoprene grommet ø 7mm grommet length 14mm |                 |   |
|  | <b>Part No.</b>   | 520330  | <b>Ref. No.</b> | — |
|   | <b>description</b>  | bracket rubber dimensions 69x44x4mm                         |                 |   |

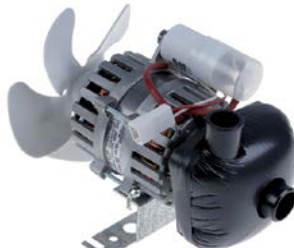

pumps for ice machines

|   |  |                 |                   |
|---|--|-----------------|-------------------|
|  |  |                 |                   |
| 1   |  |                 |                   |
| <b>Part No.</b>   | 500590   | <b>Ref. No.</b> | 30166             |
| <b>description</b>  | pump FIR type 4240.2300 120W 230V 50/60Hz inlet ø 22mm outlet ø 22mm L 240mm rotation direction right for ice-cube maker capacitor 5µF |                 |                   |
| <b>spare parts for</b>  | 500590   |                 |                   |
|  | <b>Part No.</b>  | 601412          | <b>Ref. No.</b> — |
|   | fan wheel sucking ø 154mm fan wheel mounting 25.4mm blade angle 28° W 34mm plastic   |                 |                   |
|  | <b>Part No.</b>  | 601413          | <b>Ref. No.</b> — |
|   | fixing plate suitable for fanwheel ED ø 32mm shaft ø 7 mounting distance 26mm  |                 |                   |

|   |  |                 |                   |
|---|--|-----------------|-------------------|
|   |  |                 |                   |
| 1   |  |                 |                   |
| <b>Part No.</b>   | 500165   | <b>Ref. No.</b> | 30165             |
| <b>description</b>  | pump REBO type 63/35 120W 230V 50/60Hz inlet ø 28mm outlet ø 26mm L 180mm rotation direction right for ice-cube maker capacitor 5µF  |                 |                   |
| <b>spare parts for</b>  | 500165   |                 |                   |
|  | <b>Part No.</b>  | 365017          | <b>Ref. No.</b> — |
|   | operating capacitor capacity 5µF 450V tolerance 5% 50/60Hz ambient temperature max. -25 to +85°C ø 28mm L 54mm M8 plastic connection male faston 6.3mm 16.10.08 protection |                 |                   |
|  | <b>Part No.</b>  | 601412          | <b>Ref. No.</b> — |
|   | fan wheel sucking ø 154mm fan wheel mounting 25.4mm blade angle 28° W 34mm plastic   |                 |                   |
|  | <b>Part No.</b>  | 601413          | <b>Ref. No.</b> — |
|   | fixing plate suitable for fanwheel ED ø 32mm shaft ø 7 mounting distance 26mm  |                 |                   |

electric accessories

cables

ribbon cables







group 5

|   |   |                 |       |
|---|---|-----------------|-------|
|  |   |                 |       |
| 1   |   |                 |       |
| <b>Part No.</b>   | 402568  | <b>Ref. No.</b> | 21477 |
| <b>description</b>  | ribbon cable 16-pole L 550mm plug type 2 row coded Qty 1m |                 |       |

gas thermostats

SIT

630 Eurosit series

|   |  |                 |                       |
|---|--|-----------------|-----------------------|
|   |  |                 |                       |
| 1   |  |                 |                       |
| <b>Part No.</b>   | 101188   | <b>Ref. No.</b> | 40499                 |
| <b>description</b>  | gas thermostat type 630 Eurosit series t.max. 190°C 110-190°C gas inlet 3/8" gas outlet 3/8" thermocouple connection M9x1 pilot connection M10x1 probe ø 4mm probe L 202mm capillary pipe 1050mm SIT |                 |                       |
| <b>accessories for</b>  | 101188   |                 |                       |
|    | <b>Part No.</b>  | 100904          | <b>Ref. No.</b> —     |
|   | locking screw M10x1 for pipe ø 4mm Qty 1 pcs   |                 |                       |
|    | <b>Part No.</b>  | 100905          | <b>Ref. No.</b> 42509 |
|   | locking screw M10x1 for pipe ø 6mm Qty 1 pcs   |                 |                       |
|   | <b>Part No.</b>  | 101273          | <b>Ref. No.</b> —     |
|   | olive for pipe ø 12mm L 9.5mm brass Qty 1 pcs suitable for universal   |                 |                       |
|  | <b>Part No.</b>  | 101276          | <b>Ref. No.</b> —     |
|   | union screw thread 3/8" tube ø 12mm Qty 1 pcs  |                 |                       |
|  | <b>Part No.</b>  | 101333          | <b>Ref. No.</b> —     |
|   | plug thread 3/8" with O-ring   |                 |                       |





|  |   |                 |                       |
|--|---|-----------------|-----------------------|
|  |   |                 |                       |
| 1  |   |                 |                       |
| <b>Part No.</b>  | 101125  | <b>Ref. No.</b> | 40430                 |
| <b>description</b>   | gas thermostat type 630 Eurosit series t.max. 340°C 100-340°C gas inlet 3/8" gas outlet 3/8" thermocouple connection M9x1 pilot connection M10x1 probe ø 4mm probe L 72mm capillary pipe 1050mm SIT |                 |                       |
| <b>accessories for</b>   | 101125  |                 |                       |
|   | <b>Part No.</b>   | 100825          | <b>Ref. No.</b> —     |
|  | gas tap spindle shaft ø 8x6.5mm shaft L 22/14mm suitable for EUROSIT  |                 |                       |
|   | <b>Part No.</b>   | 100904          | <b>Ref. No.</b> —     |
|  | locking screw M10x1 for pipe ø 4mm Qty 1 pcs  |                 |                       |
|   | <b>Part No.</b>   | 100905          | <b>Ref. No.</b> 42509 |
|  | locking screw M10x1 for pipe ø 6mm Qty 1 pcs  |                 |                       |

Table continues overleaf



| accessories for   |   | 101125 |            |
|---|---|--------|------------|
|  | <b>Part No.</b>   | 100949 | Ref. No. — |
|   | gasket suitable for 630 Eurosit series  |        |            |
|  | <b>Part No.</b>   | 101273 | Ref. No. — |
|   | olive for pipe ø 12mm L 9.5mm brass Qty 1 pcs suitable for universal  |        |            |
|  | <b>Part No.</b>   | 101276 | Ref. No. — |
|   | union screw thread 3/8" tube ø 12mm Qty 1 pcs   |        |            |
|  | <b>Part No.</b>   | 101333 | Ref. No. — |
|   | plug thread 3/8" with O-ring  |        |            |
|  | <b>Part No.</b>   | 101390 | Ref. No. — |
|   | gas tap spindle shaft ø 6x4.6mm shaft L 32/15mm gas tap with ignition flame suitable for ZANUSSI, MARENO for gas thermostat EUROSIT |        |            |
|  | <b>Part No.</b>   | 101392 | Ref. No. — |
|   | adapter suitable for 630 Eurosit series   |        |            |
|  | <b>Part No.</b>   | 110357 | Ref. No. — |
|   | gas tap spindle shaft ø 8x6.5mm shaft L 36/12mm suitable for 630 Eurosit series   |        |            |
|  | <b>Part No.</b>   | 110358 | Ref. No. — |
|   | adapter shaft ø 10x8mm shaft L 29/18mm suitable for 630 Eurosit series  |        |            |

| accessories for   |   | 101132 |            |
|---|---|--------|------------|
|    | <b>Part No.</b>   | 101136 | Ref. No. — |
|   | piezoelectric igniter suitable for Minisit with cover cap ømm connection F6.3x0.8 |        |            |
|    | <b>Part No.</b>   | 101137 | Ref. No. — |
|   | cover cap without piezoelectric igniter   |        |            |
|    | <b>Part No.</b>   | 101267 | Ref. No. — |
|   | reducer IT 3/8" ET 1/2" L 21mm  |        |            |
|    | <b>Part No.</b>   | 101268 | Ref. No. — |
|   | gas connection thread 3/8" angled with O-ring MINISIT 710                         |        |            |
|    | <b>Part No.</b>   | 101269 | Ref. No. — |
|   | gas connection thread 1/2" angled with O-ring MINISIT 710                         |        |            |
|    | <b>Part No.</b>   | 101270 | Ref. No. — |
|   | screw connection IT 3/8" ET 3/8" L 28mm   |        |            |
|    | <b>Part No.</b>   | 101272 | Ref. No. — |
|   | screw connection IT 1/2" ET 3/8" L 57mm   |        |            |
|    | <b>Part No.</b>   | 101273 | Ref. No. — |
|   | olive for pipe ø 12mm L 9.5mm brass Qty 1 pcs suitable for universal              |        |            |
|    | <b>Part No.</b>   | 101274 | Ref. No. — |
|   | olive for pipe ø 16mm Qty 1 pcs   |        |            |
|   | <b>Part No.</b>   | 101275 | Ref. No. — |
|   | union screw thread 1/2" for pipe ø 16mm Qty 1 pcs                                 |        |            |
|  | <b>Part No.</b>   | 101276 | Ref. No. — |
|   | union screw thread 3/8" tube ø 12mm Qty 1 pcs                                     |        |            |
|  | <b>Part No.</b>   | 110068 | Ref. No. — |
|   | knob suitable for Minisit ø 37mm  |        |            |

710 Minisit series

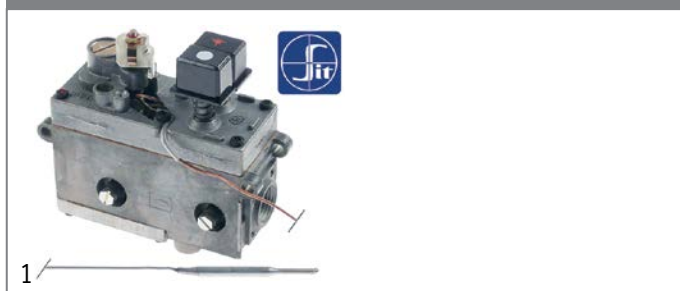

| Part No.  | 101132  | Ref. No. | 40495          |
|---|---|----------|----------------|
| <b>description</b>  | gas thermostat SIT type MINISIT 710 t.max. 340°C 100-340°C gas inlet 1/2" gas outlet 3/8" thermocouple connection M9x1 pilot connection M10x1 probe ø 5mm probe L 68mm capillary pipe 1050mm probe type type B1 pressure controller no pressure regulatormbar gland nut ignition gas no |          |                |
| <b>spare parts for</b>  | 101132  |          |                |
|  | <b>Part No.</b>   | 101053   | Ref. No. —     |
|   | magnet unit T1: M9x1 T2: M24x1 L 45mm ø 17mm suitable for Minisit   |          |                |
|  | <b>Part No.</b>   | 102102   | Ref. No. —     |
|   | probe 100-340°C probe ø 5mm probe L 68mm capillary pipe 1750mm t.max. 340°C oven/grill probe type type B1 suitable for MINISIT 710  |          |                |
| <b>accessories for</b>  | 101132  |          |                |
|  | <b>Part No.</b>   | 100809   | Ref. No. —     |
|   | O-ring EPDM thickness 2mm ID ø 21mm Qty 1 pcs   |          |                |
|  | <b>Part No.</b>   | 100904   | Ref. No. —     |
|   | locking screw M10x1 for pipe ø 4mm Qty 1 pcs  |          |                |
|  | <b>Part No.</b>   | 100905   | Ref. No. 42509 |
|   | locking screw M10x1 for pipe ø 6mm Qty 1 pcs  |          |                |
|  | <b>Part No.</b>   | 101054   | Ref. No. —     |
|   | magnet unit T1: M10x1 T2: M24x1 L 45mm ø 17mm suitable for Minisit  |          |                |

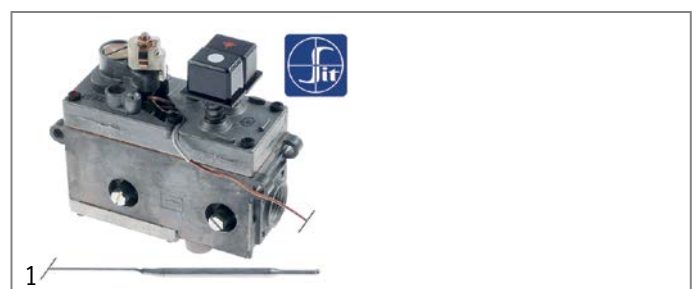



| Part No.  | 101131   | Ref. No. | 40494      |
|---|--|----------|------------|
| <b>description</b>  | gas thermostat without cap, button and angle SIT type MINISIT 710 t.max. 190°C 50-190°C gas inlet 1/2" gas outlet 3/8" thermocouple connection M9x1 pilot connection M10x1 probe ø 5mm probe L 98mm capillary pipe 1200mm probe type type A2 pressure controller no pressure regulatormbar gland nut |          |            |
| <b>spare parts for</b>  | 101131   |          |            |
|  | <b>Part No.</b>  | 101053   | Ref. No. — |
|   | magnet unit T1: M9x1 T2: M24x1 L 45mm ø 17mm suitable for Minisit  |          |            |
|  | <b>Part No.</b>  | 102103   | Ref. No. — |
|   | probe 60-200°C probe ø 5mm probe L 98mm capillary pipe 1050mm t.max. 200°C fryer probe type type A2 suitable for MINISIT 710   |          |            |

Table continues overleaf



| accessories for   |   | 101131 |                |
|---|---|--------|----------------|
|    | <b>Part No.</b>   | 100809 | Ref. No. —     |
|   | O-ring EPDM thickness 2mm ID ø 21mm Qty 1 pcs                                     |        |                |
|    | <b>Part No.</b>   | 100820 | Ref. No. —     |
|   | gland duct ET M14x1.5 IT M10x0.75 probe ø max. 6.5mm WS 22                        |        |                |
|    | <b>Part No.</b>   | 100904 | Ref. No. —     |
|   | locking screw M10x1 for pipe ø 4mm Qty 1 pcs                                      |        |                |
|    | <b>Part No.</b>   | 100905 | Ref. No. 42509 |
|   | locking screw M10x1 for pipe ø 6mm Qty 1 pcs                                      |        |                |
|    | <b>Part No.</b>   | 101054 | Ref. No. —     |
|   | magnet unit T1: M10x1 T2: M24x1 L 45mm ø 17mm suitable for Minisit                |        |                |
|    | <b>Part No.</b>   | 101136 | Ref. No. —     |
|   | piezoelectric igniter suitable for Minisit with cover cap ømm connection F6.3x0.8 |        |                |
|    | <b>Part No.</b>   | 101137 | Ref. No. —     |
|   | cover cap without piezoelectric igniter   |        |                |
|    | <b>Part No.</b>   | 101267 | Ref. No. —     |
|   | reducer IT 3/8" ET 1/2" L 21mm  |        |                |
|    | <b>Part No.</b>   | 101268 | Ref. No. —     |
|   | gas connection thread 3/8" angled with O-ring MINISIT 710                         |        |                |
|   | <b>Part No.</b>   | 101269 | Ref. No. —     |
|   | gas connection thread 1/2" angled with O-ring MINISIT 710                         |        |                |
|  | <b>Part No.</b>   | 101270 | Ref. No. —     |
|   | screw connection IT 3/8" ET 3/8" L 28mm   |        |                |
|  | <b>Part No.</b>   | 101272 | Ref. No. —     |
|   | screw connection IT 1/2" ET 3/8" L 57mm   |        |                |
|  | <b>Part No.</b>   | 101273 | Ref. No. —     |
|   | olive for pipe ø 12mm L 9.5mm brass Qty 1 pcs suitable for universal              |        |                |
|  | <b>Part No.</b>   | 101274 | Ref. No. —     |
|   | olive for pipe ø 16mm Qty 1 pcs   |        |                |
|  | <b>Part No.</b>   | 101275 | Ref. No. —     |
|   | union screw thread 1/2" for pipe ø 16mm Qty 1 pcs                                 |        |                |
|  | <b>Part No.</b>   | 101276 | Ref. No. —     |
|   | union screw thread 3/8" tube ø 12mm Qty 1 pcs                                     |        |                |
|  | <b>Part No.</b>   | 110068 | Ref. No. —     |
|   | knob suitable for Minisit ø 37mm  |        |                |

| accessories  |  |                 |       |
|--|--|-----------------|-------|
| probes   |  |                 |       |
|  |  |                 |       |
| <b>Part No.</b>  | 106225 <sup>1</sup>  | <b>Ref. No.</b> | 40973 |
| <b>description</b>   | probe 120-200°C probe ø 6mm probe L 102mm capillary pipe 1050mm t.max. 200°C fryer probe type type D1 suitable for MINISIT 710 |                 |       |

<sup>1</sup>gland box M14x1,5

## PEL

### 24STS series







|   |   |                 |            |
|---|---|-----------------|------------|
|   |   |                 |            |
| <b>Part No.</b>   | 101161  | <b>Ref. No.</b> | 41264      |
| <b>description</b>  | gas thermostat PEL type 24STS 120-320°C gas inlet M20x1.5 (tube ø 12/10mm) bypass nozzle ø 0.35mm gas outlet M20x1.5 (tube ø 12/10mm) thermocouple connection M9x1 pilot connection M10x1 capillary pipe 1200mm probe ø 6mm probe L 100mm shaft ø 10x8mm shaft L 27/17mm shaft flat upper |                 |            |
| <b>spare parts for</b>  | 101161  |                 |            |
|  | <b>Part No.</b>   | 101058          | Ref. No. — |
|   | magnet unit L 39mm D1 ø 15.4mm D2 ø 13.5mm suitable for PEL22/ EGA24197 standard  |                 |            |
| <b>accessories for</b>  | 101161  |                 |            |
|  | <b>Part No.</b>   | 101235          | Ref. No. — |
|   | gas connection thread M20x1.5 tube ø 12/10mm for PEL gas taps horizontal  |                 |            |
|  | <b>Part No.</b>   | 101236          | Ref. No. — |
|   | gas connection thread M20x1.5 tube ø 12/10mm for PEL gas taps vertical  |                 |            |
|  | <b>Part No.</b>   | 101240          | Ref. No. — |
|   | gas connection thread M20x1.5 tube ø 12/10mm for PEL gas taps with gasket and screws horizontal   |                 |            |
|  | <b>Part No.</b>   | 101241          | Ref. No. — |
|   | gas connection thread M20x1.5 tube ø 12/10mm for PEL gas taps vertical  |                 |            |
|  | <b>Part No.</b>   | 101248          | Ref. No. — |
|   | olive for pipe ø 12mm Qty 1 pcs suitable for PEL  |                 |            |
|  | <b>Part No.</b>   | 101249          | Ref. No. — |
|   | olive for pipe ø 10mm Qty 1 pcs   |                 |            |
|  | <b>Part No.</b>   | 101250          | Ref. No. — |
|   | union nut thread M20x1.5 for pipe ø 10mm  |                 |            |
|  | <b>Part No.</b>   | 101251          | Ref. No. — |
|   | union nut thread M20x1.5 for pipe ø 12mm  |                 |            |
|  | <b>Part No.</b>   | 101365          | Ref. No. — |
|   | gas connection thread M20x1.5 tube ø 12mm for PEL gas taps horizontal   |                 |            |

Table continues overleaf



|   |   |        |            |
|---|---|--------|------------|
| accessories for   | 101161  |        |            |
|  | <b>Part No.</b>                                 | 101460 | Ref. No. — |
|   | O-ring ø 12.37mm D1 ø 2.62mm suitable for PEL22 |        |            |
|  | <b>Part No.</b>                                 | 101461 | Ref. No. — |
|   | screw kit suitable for PEL22 Qty 4 pcs          |        |            |
|  | <b>Part No.</b>                                 | 110079 | Ref. No. — |
|   | knob dial plate gas thermostat 1-8 silver       |        |            |
|  | <b>Part No.</b>                                 | 110080 | Ref. No. — |
|   | knob ø 70mm shaft ø 10x8mm shaft flat universal |        |            |









## gas valves and ignition boxes

### gas control valves

#### SIT

#### ELETTROSIT

|   |   |                 |                |
|---|---|-----------------|----------------|
|   |   |                 |                |
| 1   |   |                 |                |
| <b>Part No.</b>   | 101123  | <b>Ref. No.</b> | 40492          |
| <b>description</b>  | gas valve SIT type ELETTROSIT 230V gas inlet 3/4" gas outlet 3/4" thermocouple connection M9x1 pilot connection M10x1 bottom equiv. no. 0.810.138 |                 |                |
| <b>spare parts for</b>  | 101123  |                 |                |
|  | <b>Part No.</b>   | 101312          | Ref. No. —     |
|   | microswitch   |                 |                |
|  | <b>Part No.</b>   | 101352          | Ref. No. —     |
|   | solenoid coil 230V 50Hz suitable for ELETTROSIT   |                 |                |
| <b>accessories for</b>  | 101123  |                 |                |
|  | <b>Part No.</b>   | 100006          | Ref. No. —     |
|   | piezoelectric igniter suitable for ELETTROSIT body plastic blowing connection ø2.4mm ø 14mm   |                 |                |
|  | <b>Part No.</b>   | 100904          | Ref. No. —     |
|   | locking screw M10x1 for pipe ø 4mm Qty 1 pcs  |                 |                |
|  | <b>Part No.</b>   | 100905          | Ref. No. 42509 |
|   | locking screw M10x1 for pipe ø 6mm Qty 1 pcs  |                 |                |
|  | <b>Part No.</b>   | 101301          | Ref. No. —     |
|   | gas connection thread 1/2" straight ELETTROSIT screw with O-ring  |                 |                |
|  | <b>Part No.</b>   | 101303          | Ref. No. —     |
|   | gas connection straight thread 3/4" ELETTROSIT  |                 |                |
|  | <b>Part No.</b>   | 101309          | Ref. No. —     |
|   | extension   |                 |                |

|   |  |                 |                |
|---|--|-----------------|----------------|
|   |  |                 |                |
| 1   |  |                 |                |
| <b>Part No.</b>   | 101127   | <b>Ref. No.</b> | 40422          |
| <b>description</b>  | gas valve SIT type ELETTROSIT 230V gas inlet 3/4" gas outlet 3/4" thermocouple connection M9x1 pilot connection M10x1 lateral equiv. no. 0.810.175 |                 |                |
| <b>spare parts for</b>  | 101127   |                 |                |
|    | <b>Part No.</b>  | 101312          | Ref. No. —     |
|   | microswitch  |                 |                |
|    | <b>Part No.</b>  | 101352          | Ref. No. —     |
|   | solenoid coil 230V 50Hz suitable for ELETTROSIT  |                 |                |
| <b>accessories for</b>  | 101127   |                 |                |
|    | <b>Part No.</b>  | 100006          | Ref. No. —     |
|   | piezoelectric igniter suitable for ELETTROSIT body plastic blowing connection ø2.4mm ø 14mm  |                 |                |
|   | <b>Part No.</b>  | 100904          | Ref. No. —     |
|   | locking screw M10x1 for pipe ø 4mm Qty 1 pcs   |                 |                |
|  | <b>Part No.</b>  | 100905          | Ref. No. 42509 |
|   | locking screw M10x1 for pipe ø 6mm Qty 1 pcs   |                 |                |
|  | <b>Part No.</b>  | 101301          | Ref. No. —     |
|   | gas connection thread 1/2" straight ELETTROSIT screw with O-ring   |                 |                |
|  | <b>Part No.</b>  | 101303          | Ref. No. —     |
|   | gas connection straight thread 3/4" ELETTROSIT   |                 |                |
|  | <b>Part No.</b>  | 101309          | Ref. No. —     |
|   | extension  |                 |                |











**NOVASIT**







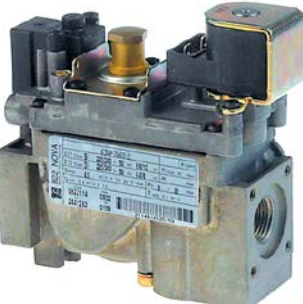



1

|   |   |                 |            |
|---|---|-----------------|------------|
| <b>Part No.</b>   | 101187  | <b>Ref. No.</b> | 40498      |
| <b>description</b>  | gas valve SIT series Novasit 820 0.17VHz gas inlet 1/2" gas outlet 1/2" thermocouple connection M9x1 pilot connection M10x1 ignition pressurebar pressure range 5-50mbar pressure regulator connection blind equiv. no. 0.820.301 supply Operator millivolt |                 |            |
| <b>spare parts for</b>  | 101187  |                 |            |
|    | <b>Part No.</b>   | 101065          | Ref. No. — |
|   | magnet unit with cable L 44mm D1 ø 30mm D2 ø 20mm suitable for NOVASIT  |                 |            |
| <b>accessories for</b>  | 101187  |                 |            |
|    | <b>Part No.</b>   | 100110          | Ref. No. — |
|   | pilot burner SIT type 190 series 3 flames nozzle ømm gas connectionmm   |                 |            |
|   | <b>Part No.</b>   | 101305          | Ref. No. — |
|   | gas connection straight 1/2" flange 45x45mm ELETTROSIT/V4400/4600/4605 suitable for SIT/HONEYWELL hole distance 36x36mm   |                 |            |
|  | <b>Part No.</b>   | 101306          | Ref. No. — |
|   | gas connection angled flange 45x45mm hole distance 36x36mm 1/2" ELETTROSIT/V4400/4600/4605 screw with O-ring suitable for SIT/HONEYWELL   |                 |            |
|  | <b>Part No.</b>   | 101307          | Ref. No. — |
|   | gas connection straight flange 45x45mm hole distance 36x36mm 3/4" ELETTROSIT/V4400/4600/4605 screw with O-ring suitable for SIT/HONEYWELL   |                 |            |
|  | <b>Part No.</b>   | 101308          | Ref. No. — |
|   | gas connection angled flange 45x45mm hole distance 36x36mm 3/4" ELETTROSIT/V4400/4600/4605 screw with O-ring suitable for SIT/HONEYWELL   |                 |            |
|  | <b>Part No.</b>   | 102116          | Ref. No. — |
|   | thermopile ROBERTSHAW L 900mm probe ø 9mm probe L 57mm 250-750mV screw connection 7/16"   |                 |            |



1

|   |   |                 |                |
|---|---|-----------------|----------------|
| <b>Part No.</b>   | 101914  | <b>Ref. No.</b> | 40421          |
| <b>description</b>  | gas valve SIT series Novasit 822 230V 50Hz gas inlet 1/2" gas outlet 1/2" thermocouple connection pilot connection closed ignition pressurebar pressure range 3-30mbar pressure regulator connection blind equiv. no. 0.822.144 |                 |                |
| <b>spare parts for</b>  | 101914  |                 |                |
|  | <b>Part No.</b>   | 101313          | Ref. No. 42623 |
|   | solenoid coil 230V 50Hz   |                 |                |

|   |   |        |            |
|---|---|--------|------------|
| <b>spare parts for</b>  | 101914  |        |            |
|  | <b>Part No.</b>   | 101542 | Ref. No. — |
|   | solenoid coil 50Hz NOVA 822/826/827 suitable for NOVASIT 230V   |        |            |
| <b>accessories for</b>  | 101914  |        |            |
|  | <b>Part No.</b>   | 101305 | Ref. No. — |
|   | gas connection straight 1/2" flange 45x45mm ELETTROSIT/V4400/4600/4605 suitable for SIT/HONEYWELL hole distance 36x36mm                   |        |            |
|  | <b>Part No.</b>   | 101306 | Ref. No. — |
|   | gas connection angled flange 45x45mm hole distance 36x36mm 1/2" ELETTROSIT/V4400/4600/4605 screw with O-ring suitable for SIT/HONEYWELL   |        |            |
|  | <b>Part No.</b>   | 101307 | Ref. No. — |
|   | gas connection straight flange 45x45mm hole distance 36x36mm 3/4" ELETTROSIT/V4400/4600/4605 screw with O-ring suitable for SIT/HONEYWELL |        |            |
|  | <b>Part No.</b>   | 101308 | Ref. No. — |
|   | gas connection angled flange 45x45mm hole distance 36x36mm 3/4" ELETTROSIT/V4400/4600/4605 screw with O-ring suitable for SIT/HONEYWELL   |        |            |
|  | <b>Part No.</b>   | 101503 | Ref. No. — |
|   | O-ring EPDM thickness 2mm ID ø 32mm Qty 1 pcs   |        |            |
|  | <b>Part No.</b>   | 101924 | Ref. No. — |
|   | plug with cable L 1090mm suitable for NOVA 822/826/827  |        |            |

**accessories**



1

|                    |  |                 |       |
|--------------------|--|-----------------|-------|
| <b>Part No.</b>    | 100905                                       | <b>Ref. No.</b> | 42509 |
| <b>description</b> | locking screw M10x1 for pipe ø 6mm Qty 1 pcs |                 |       |



1

|   |                                      |                 |            |
|---|--------------------------------------|-----------------|------------|
| <b>Part No.</b>   | 101313                               | <b>Ref. No.</b> | 42623      |
| <b>description</b>  | solenoid coil 230V 50Hz              |                 |            |
| <b>accessories for</b>  | 101313                               |                 |            |
|  | <b>Part No.</b>                      | 550896          | Ref. No. — |
|   | gasket with screw gas valves NOVASIT |                 |            |



## ignition parts









### pilot burners

SIT

100 series















1

|   |  |                 |                |
|---|--|-----------------|----------------|
| <b>Part No.</b>   | 106901   | <b>Ref. No.</b> | 40471          |
| <b>description</b>  | pilot burner SIT type 100 series 1 flame nozzle $\varnothing$ 0.2mm gas connection 6mm |                 |                |
| <b>spare parts for</b>  | 106901   |                 |                |
|    | <b>Part No.</b>  | 100854          | Ref. No. —     |
|   | pilot burner bracket double  |                 |                |
|    | <b>Part No.</b>  | 100916          | Ref. No. —     |
|   | compression spring for pilot burner Qty 1 pcs  |                 |                |
|    | <b>Part No.</b>  | 100917          | Ref. No. —     |
|   | gasket for pilot burner Qty 1 pcs aluminium  |                 |                |
|   | <b>Part No.</b>  | 100918          | Ref. No. —     |
|   | screw for pilot burner   |                 |                |
| <b>accessories for</b>  | 106901   |                 |                |
|  | <b>Part No.</b>  | 100904          | Ref. No. —     |
|   | locking screw M10x1 for pipe $\varnothing$ 4mm Qty 1 pcs                               |                 |                |
|  | <b>Part No.</b>  | 100905          | Ref. No. 42509 |
|   | locking screw M10x1 for pipe $\varnothing$ 6mm Qty 1 pcs                               |                 |                |
|  | <b>Part No.</b>  | 102110          | Ref. No. —     |
|   | pilot tube copper pipe $\varnothing$ 4mm thickness 1mm L 3000mm                        |                 |                |
|  | <b>Part No.</b>  | 102111          | Ref. No. —     |
|   | pilot tube copper pipe $\varnothing$ 6mm thickness 1mm L 3000mm                        |                 |                |
|  | <b>Part No.</b>  | 102742          | Ref. No. —     |
|   | pilot burner nozzle LPG code 25 bore $\varnothing$ 0.25mm Qty 1 pcs                    |                 |                |













1

|   |   |                 |            |
|---|---|-----------------|------------|
| <b>Part No.</b>   | 106902  | <b>Ref. No.</b> | 40014      |
| <b>description</b>  | pilot burner SIT type 100 series 2 flames nozzle $\varnothing$ 0.2mm gas connection 6mm |                 |            |
| <b>spare parts for</b>  | 106902  |                 |            |
|  | <b>Part No.</b>   | 100245          | Ref. No. — |
|   | pilot burner nozzle LPG code 20 bore $\varnothing$ 0.2mm Qty 1 pcs thread M8x0.75       |                 |            |

|   |  |        |                |
|---|--|--------|----------------|
| <b>spare parts for</b>  | 106902   |        |                |
|    | <b>Part No.</b>  | 100842 | Ref. No. —     |
|   | pilot burner cap 2 flames Qty 1 pcs  |        |                |
|    | <b>Part No.</b>  | 100885 | Ref. No. —     |
|   | air mixing sleeve for pilot burner Qty 1 pcs                                       |        |                |
|    | <b>Part No.</b>  | 100916 | Ref. No. —     |
|   | compression spring for pilot burner Qty 1 pcs                                      |        |                |
|    | <b>Part No.</b>  | 100917 | Ref. No. —     |
|   | gasket for pilot burner Qty 1 pcs aluminium  |        |                |
|    | <b>Part No.</b>  | 100918 | Ref. No. —     |
|   | screw for pilot burner   |        |                |
|    | <b>Part No.</b>  | 107161 | Ref. No. —     |
|   | pilot burner cap SIT 2 flames Hmm Lmm Qty 1 pcs                                    |        |                |
|    | <b>Part No.</b>  | 107701 | Ref. No. —     |
|   | pilot burner bottom part SIT 100 series nozzle $\varnothing$ 0.2mm                 |        |                |
| <b>accessories for</b>  | 106902   |        |                |
|    | <b>Part No.</b>  | 100246 | Ref. No. —     |
|   | pilot burner nozzle natural gas bore $\varnothing$ 0.35mm Qty 1 pcs thread M8x0.75 |        |                |
|   | <b>Part No.</b>  | 100904 | Ref. No. —     |
|   | locking screw M10x1 for pipe $\varnothing$ 4mm Qty 1 pcs                           |        |                |
|  | <b>Part No.</b>  | 100905 | Ref. No. 42509 |
|   | locking screw M10x1 for pipe $\varnothing$ 6mm Qty 1 pcs                           |        |                |
|  | <b>Part No.</b>  | 102110 | Ref. No. —     |
|   | pilot tube copper pipe $\varnothing$ 4mm thickness 1mm L 3000mm                    |        |                |
|  | <b>Part No.</b>  | 102111 | Ref. No. —     |
|   | pilot tube copper pipe $\varnothing$ 6mm thickness 1mm L 3000mm                    |        |                |
|  | <b>Part No.</b>  | 107171 | Ref. No. —     |
|   | pilot burner nozzle SIT natural/liquid gas bore $\varnothing$ 0.25mm Qty 1 pcs     |        |                |
|  | <b>Part No.</b>  | 107700 | Ref. No. —     |
|   | pilot burner bottom part SIT 100 series nozzle $\varnothing$ 0.25mm                |        |                |
|  | <b>Part No.</b>  | 107702 | Ref. No. —     |
|   | pilot burner bottom part SIT 100 series nozzle $\varnothing$ 0.35mm                |        |                |

1 gas components



|   |   |                 |                       |
|---|---|-----------------|-----------------------|
|    |   |                 |                       |
| 1   |   |                 |                       |
| <b>Part No.</b>   | 106903  | <b>Ref. No.</b> | 41703                 |
| <b>description</b>  | pilot burner SIT type 100 series 3 flames nozzle $\varnothing$ 0.2mm gas connection 6mm |                 |                       |
| <b>spare parts for</b>  | 106903  |                 |                       |
|    | <b>Part No.</b>   | 100245          | <b>Ref. No.</b> —     |
|   | pilot burner nozzle LPG code 20 bore $\varnothing$ 0.2mm Qty 1 pcs thread M8x0.75       |                 |                       |
|    | <b>Part No.</b>   | 100854          | <b>Ref. No.</b> —     |
|   | pilot burner bracket double   |                 |                       |
|    | <b>Part No.</b>   | 100885          | <b>Ref. No.</b> —     |
|   | air mixing sleeve for pilot burner Qty 1 pcs  |                 |                       |
|    | <b>Part No.</b>   | 100916          | <b>Ref. No.</b> —     |
|   | compression spring for pilot burner Qty 1 pcs   |                 |                       |
|    | <b>Part No.</b>   | 100917          | <b>Ref. No.</b> —     |
|   | gasket for pilot burner Qty 1 pcs aluminium   |                 |                       |
|   | <b>Part No.</b>   | 100918          | <b>Ref. No.</b> —     |
|   | screw for pilot burner  |                 |                       |
|  | <b>Part No.</b>   | 107162          | <b>Ref. No.</b> —     |
|   | pilot burner cap SIT 3 flames Hmm Lmm Qty 1 pcs   |                 |                       |
|  | <b>Part No.</b>   | 107701          | <b>Ref. No.</b> —     |
|   | pilot burner bottom part SIT 100 series nozzle $\varnothing$ 0.2mm                      |                 |                       |
| <b>accessories for</b>  | 106903  |                 |                       |
|  | <b>Part No.</b>   | 100245          | <b>Ref. No.</b> —     |
|   | pilot burner nozzle LPG code 20 bore $\varnothing$ 0.2mm Qty 1 pcs thread M8x0.75       |                 |                       |
|  | <b>Part No.</b>   | 100246          | <b>Ref. No.</b> —     |
|   | pilot burner nozzle natural gas bore $\varnothing$ 0.35mm Qty 1 pcs thread M8x0.75      |                 |                       |
|  | <b>Part No.</b>   | 100904          | <b>Ref. No.</b> —     |
|   | locking screw M10x1 for pipe $\varnothing$ 4mm Qty 1 pcs                                |                 |                       |
|  | <b>Part No.</b>   | 100905          | <b>Ref. No.</b> 42509 |
|   | locking screw M10x1 for pipe $\varnothing$ 6mm Qty 1 pcs                                |                 |                       |
|  | <b>Part No.</b>   | 102110          | <b>Ref. No.</b> —     |
|   | pilot tube copper pipe $\varnothing$ 4mm thickness 1mm L 3000mm                         |                 |                       |
|  | <b>Part No.</b>   | 102111          | <b>Ref. No.</b> —     |
|   | pilot tube copper pipe $\varnothing$ 6mm thickness 1mm L 3000mm                         |                 |                       |
|  | <b>Part No.</b>   | 107171          | <b>Ref. No.</b> —     |
|   | pilot burner nozzle SIT natural/liquid gas bore $\varnothing$ 0.25mm Qty 1 pcs          |                 |                       |
|  | <b>Part No.</b>   | 107700          | <b>Ref. No.</b> —     |
|   | pilot burner bottom part SIT 100 series nozzle $\varnothing$ 0.25mm                     |                 |                       |

|   |   |        |                   |
|---|---|--------|-------------------|
| <b>accessories for</b>  | 106903  |        |                   |
|  | <b>Part No.</b>   | 107702 | <b>Ref. No.</b> — |
|   | pilot burner bottom part SIT 100 series nozzle $\varnothing$ 0.35mm |        |                   |





















|   |   |                 |                       |
|---|---|-----------------|-----------------------|
|   |   |                 |                       |
| 1   |   |                 |                       |
| <b>Part No.</b>   | 106906  | <b>Ref. No.</b> | 40016                 |
| <b>description</b>  | pilot burner SIT type 100 series 3 flames nozzle $\varnothing$ 0.2mm gas connection 6mm |                 |                       |
| <b>spare parts for</b>  | 106906  |                 |                       |
|    | <b>Part No.</b>   | 100245          | <b>Ref. No.</b> —     |
|   | pilot burner nozzle LPG code 20 bore $\varnothing$ 0.2mm Qty 1 pcs thread M8x0.75       |                 |                       |
|    | <b>Part No.</b>   | 100855          | <b>Ref. No.</b> —     |
|   | pilot burner bracket triple   |                 |                       |
|    | <b>Part No.</b>   | 100885          | <b>Ref. No.</b> —     |
|   | air mixing sleeve for pilot burner Qty 1 pcs  |                 |                       |
|    | <b>Part No.</b>   | 100916          | <b>Ref. No.</b> —     |
|   | compression spring for pilot burner Qty 1 pcs   |                 |                       |
|  | <b>Part No.</b>   | 100917          | <b>Ref. No.</b> —     |
|   | gasket for pilot burner Qty 1 pcs aluminium   |                 |                       |
|  | <b>Part No.</b>   | 100918          | <b>Ref. No.</b> —     |
|   | screw for pilot burner  |                 |                       |
|  | <b>Part No.</b>   | 107162          | <b>Ref. No.</b> —     |
|   | pilot burner cap SIT 3 flames Hmm Lmm Qty 1 pcs   |                 |                       |
|  | <b>Part No.</b>   | 107701          | <b>Ref. No.</b> —     |
|   | pilot burner bottom part SIT 100 series nozzle $\varnothing$ 0.2mm                      |                 |                       |
| <b>accessories for</b>  | 106906  |                 |                       |
|  | <b>Part No.</b>   | 100245          | <b>Ref. No.</b> —     |
|   | pilot burner nozzle LPG code 20 bore $\varnothing$ 0.2mm Qty 1 pcs thread M8x0.75       |                 |                       |
|  | <b>Part No.</b>   | 100246          | <b>Ref. No.</b> —     |
|   | pilot burner nozzle natural gas bore $\varnothing$ 0.35mm Qty 1 pcs thread M8x0.75      |                 |                       |
|  | <b>Part No.</b>   | 100904          | <b>Ref. No.</b> —     |
|   | locking screw M10x1 for pipe $\varnothing$ 4mm Qty 1 pcs                                |                 |                       |
|  | <b>Part No.</b>   | 100905          | <b>Ref. No.</b> 42509 |
|   | locking screw M10x1 for pipe $\varnothing$ 6mm Qty 1 pcs                                |                 |                       |
|  | <b>Part No.</b>   | 102110          | <b>Ref. No.</b> —     |
|   | pilot tube copper pipe $\varnothing$ 4mm thickness 1mm L 3000mm                         |                 |                       |
|  | <b>Part No.</b>   | 102111          | <b>Ref. No.</b> —     |
|   | pilot tube copper pipe $\varnothing$ 6mm thickness 1mm L 3000mm                         |                 |                       |













Table continues overleaf



|   |  |        |            |
|---|--|--------|------------|
| accessories for   | 106906   |        |            |
|  | <b>Part No.</b>  | 107171 | Ref. No. — |
|   | pilot burner nozzle SIT natural/liquid gas bore $\varnothing$ 0.25mm Qty 1 pcs |        |            |
|  | <b>Part No.</b>  | 107700 | Ref. No. — |
|   | pilot burner bottom part SIT 100 series nozzle $\varnothing$ 0.25mm            |        |            |
|  | <b>Part No.</b>  | 107702 | Ref. No. — |
|   | pilot burner bottom part SIT 100 series nozzle $\varnothing$ 0.35mm            |        |            |



|   |   |        |            |
|---|---|--------|------------|
| accessories for   | 107114  |        |            |
|  | <b>Part No.</b>   | 100909 | Ref. No. — |
|   | union screw thread M10x1 for pipe $\varnothing$ 6mm Qty 1 pcs   |        |            |
|  | <b>Part No.</b>   | 102110 | Ref. No. — |
|   | pilot tube copper pipe $\varnothing$ 4mm thickness 1mm L 3000mm |        |            |
|  | <b>Part No.</b>   | 102111 | Ref. No. — |
|   | pilot tube copper pipe $\varnothing$ 6mm thickness 1mm L 3000mm |        |            |

140 - 145 -150 series

|   |  |  |                |
|---|--|--|----------------|
|    |  |  |                |
| 1   | <b>Part No.</b>  | 107114 <sup>1</sup>  | Ref. No. 40472 |
|   | <b>description</b>   | pilot burner SIT type 140 series 2 flames nozzle $\varnothing$ mm gas connectionmm |                |
|   | <b>spare parts for</b>   | 107114   |                |
|    | <b>Part No.</b>  | 100907   | Ref. No. —     |
|   | screw connection thread M10x1 Qty 1 pcs type SEF 1 $\varnothing$ mm for thermocouple                             |  |                |
| accessories for   | 107114   |  |                |
|   | <b>Part No.</b>  | 100204   | Ref. No. 41007 |
|   | pilot burner nozzle SIT LPG code 14 bore $\varnothing$ 0.18/0.20mm Qty 1 pcs suitable for 140 series             |  |                |
|  | <b>Part No.</b>  | 100205   | Ref. No. —     |
|   | pilot burner nozzle SIT LPG code 19 bore $\varnothing$ 0.23/0.26mm Qty 1 pcs suitable for SIT 150 series         |  |                |
|  | <b>Part No.</b>  | 100206   | Ref. No. —     |
|   | pilot burner nozzle SIT natural gas code 36 bore $\varnothing$ 0.60/0.55mm Qty 1 pcs suitable for SIT 150 series |  |                |
|  | <b>Part No.</b>  | 100207   | Ref. No. 40292 |
|   | pilot burner nozzle SIT natural gas code 27 bore $\varnothing$ 0.40/0.38mm suitable for SIT 140 series           |  |                |
|  | <b>Part No.</b>  | 100216   | Ref. No. —     |
|   | pilot burner nozzle SIT natural gas code 38 bore $\varnothing$ 0.45mm Qty 1 pcs suitable for SIT 150 series      |  |                |
|  | <b>Part No.</b>  | 100701   | Ref. No. 9611  |
|   | ignition electrode connection M4 Qty 1 pcs   |  |                |
|  | <b>Part No.</b>  | 100801   | Ref. No. —     |
|   | gasket for pilot burner Qty 1 pcs  |  |                |
|  | <b>Part No.</b>  | 100897   | Ref. No. —     |
|   | olive for pipe $\varnothing$ 4mm Qty 1 pcs for pilot burner  |  |                |
|  | <b>Part No.</b>  | 100898   | Ref. No. —     |
|   | olive for pipe $\varnothing$ 6mm Qty 1 pcs for pilot burner  |  |                |
|  | <b>Part No.</b>  | 100906   | Ref. No. —     |
|   | screw connection thread M10x1 for ignition electrode brass Qty 1 pcs WS 10                                       |  |                |
|  | <b>Part No.</b>  | 100908   | Ref. No. —     |
|   | union screw thread M10x1 for pipe $\varnothing$ 4mm Qty 1 pcs  |  |                |

<sup>1</sup>incl. thermocouple fitting

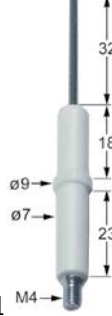
electrodes

|  |  |  |               |
|--|--|--|---------------|
|   |  |  |               |
| 1  | <b>Part No.</b>  | 100701                                     | Ref. No. 9611 |
|  | <b>description</b>   | ignition electrode connection M4 Qty 1 pcs |               |
| accessories for  | 100701   |  |               |
|  | <b>Part No.</b>  | 100906                                     | Ref. No. —    |
|  | screw connection thread M10x1 for ignition electrode brass Qty 1 pcs WS 10 |  |               |

ignition cables

pre-assembled cables

|  |                    |   |                |
|--|--------------------|---|----------------|
|  |                    |   |                |
| 1  | <b>Part No.</b>    | 102155  | Ref. No. 41698 |
|  | <b>description</b> | ignition cable cable length 900mm connection $\varnothing$ 4mm / F2.8mm |                |

piezoelectric igniters

mounting diameter 18mm





|  |  |   |                     |
|--|--|---|---------------------|
|  |  |   |                     |
| 1  | <b>Part No.</b>  | 100009  | Ref. No. 4182 70473 |
|  | <b>description</b>   | piezoelectric igniter body plastic blowing mounting $\varnothing$ 18mm connection $\varnothing$ 2.4mm front measurements 26mm M18x1.5 |                     |
| accessories for  | 100009   |   |                     |
|   | <b>Part No.</b>  | 101339  | Ref. No. —          |
|  | cover cap for piezoelectric igniter  |   |                     |
|   | <b>Part No.</b>  | 106869  | Ref. No. —          |
|  | cover cap for piezoelectric igniter ID $\varnothing$ 22mm ED $\varnothing$ 35mm H 25mm |   |                     |

Table continues overleaf



|   |                        |                 |   |
|---|------------------------|-----------------|---|
| accessories for   | 100009                 |                 |   |
|  | <b>Part No.</b> 107931 | <b>Ref. No.</b> | — |
| cover cap for piezoelectric igniter ID $\varnothing$ 21mm ED $\varnothing$ 36mm   |                        |                 |   |

## miscellaneous

|  |                                  |                       |  |
|--|----------------------------------|-----------------------|--|
|                   |                                  |                       |  |
| 1  | <b>Part No.</b> nla <sup>1</sup> | <b>Ref. No.</b> 41192 |  |
| <b>description</b> piezoelectric igniter suitable for Minisit connection F6.3x0.8 $\varnothing$ mm |                                  |                       |  |

<sup>1</sup>no longer available

## thermocouples

### plug-in thermocouples

#### plug-in thermocouples standard

with barrel socket  $\varnothing$ 6(6.5)mm

#### thermocouples SIT

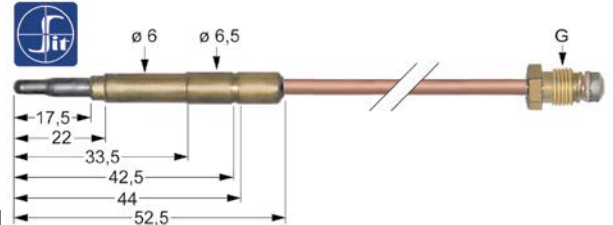
|  |                        |                       |  |
|--|------------------------|-----------------------|--|
|          |                        |                       |  |
| 1  | <b>Part No.</b> 107612 | <b>Ref. No.</b> 41550 |  |
| <b>description</b> thermocouple SIT M9x1 L 1000mm plug connection $\varnothing$ 6.0(6.5)mm |                        |                       |  |

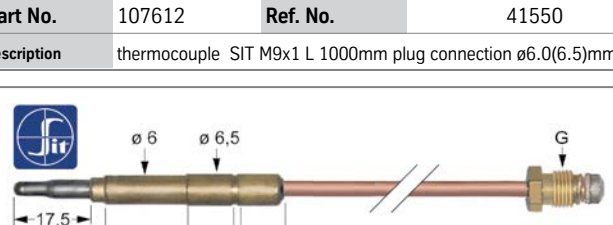
|  |                        |                       |  |
|--|------------------------|-----------------------|--|
|         |                        |                       |  |
| 1  | <b>Part No.</b> 107613 | <b>Ref. No.</b> 40535 |  |
| <b>description</b> thermocouple SIT M9x1 L 1200mm plug connection $\varnothing$ 6.0(6.5)mm |                        |                       |  |

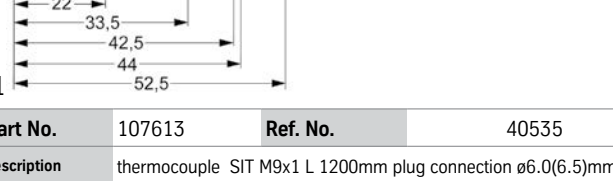
|  |                        |                       |  |
|--|------------------------|-----------------------|--|
|         |                        |                       |  |
| 1  | <b>Part No.</b> 107614 | <b>Ref. No.</b> 40362 |  |
| <b>description</b> thermocouple SIT M9x1 L 1500mm plug connection $\varnothing$ 6.0(6.5)mm |                        |                       |  |

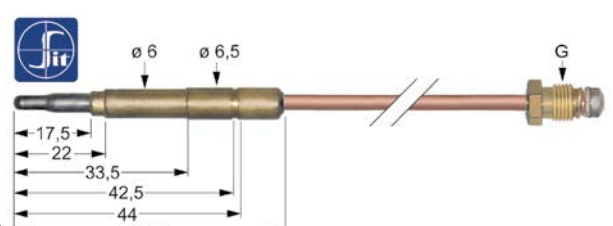
|  |                        |                       |  |
|--|------------------------|-----------------------|--|
|     |                        |                       |  |
| 1  | <b>Part No.</b> 102036 | <b>Ref. No.</b> 70551 |  |
| <b>description</b> thermocouple M8x1 L 1000mm plug connection $\varnothing$ 6.0(6.5)mm |                        |                       |  |

## thermocouples with aluminised tip

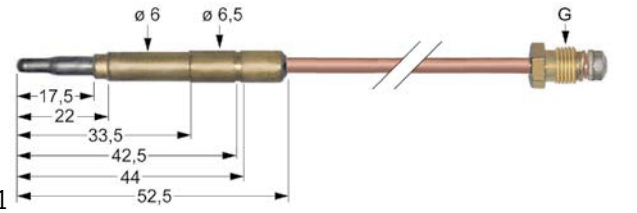
|   |                        |                       |  |
|---|------------------------|-----------------------|--|
|     |                        |                       |  |
| 1   | <b>Part No.</b> 102035 | <b>Ref. No.</b> 43057 |  |
| <b>description</b> thermocouple M8x1 L 850mm plug connection $\varnothing$ 6.0(6.5)mm |                        |                       |  |

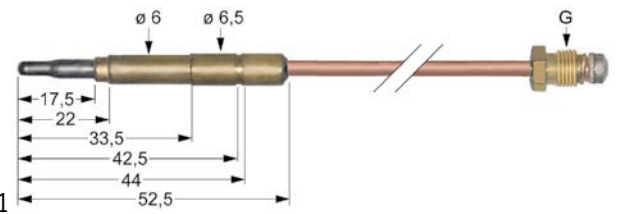
|   |                        |                       |  |
|---|------------------------|-----------------------|--|
|     |                        |                       |  |
| 1   | <b>Part No.</b> 102041 | <b>Ref. No.</b> 40534 |  |
| <b>description</b> thermocouple M9x1 L 600mm plug connection $\varnothing$ 6.0(6.5)mm |                        |                       |  |

|  |                        |                       |  |
|--|------------------------|-----------------------|--|
|  |                        |                       |  |
| 1  | <b>Part No.</b> 102067 | <b>Ref. No.</b> 40540 |  |
| <b>description</b> nut thread M8x1 H 3mm brass Qty 1 pcs type SEF 1                |                        |                       |  |

|  |                        |                       |  |
|--|------------------------|-----------------------|--|
|  |                        |                       |  |
| 1  | <b>Part No.</b> 102500 | <b>Ref. No.</b> 40540 |  |
| <b>description</b> nut thread M8x1 Qty 10 pcs                                      |                        |                       |  |

|  |                        |                       |  |
|--|------------------------|-----------------------|--|
|  |                        |                       |  |
| 1  | <b>Part No.</b> 102067 | <b>Ref. No.</b> 40540 |  |
| <b>description</b> nut thread M8x1 H 3mm brass Qty 1 pcs type SEF 1                |                        |                       |  |

|   |                        |                       |  |
|---|------------------------|-----------------------|--|
|  |                        |                       |  |
| 1   | <b>Part No.</b> 102500 | <b>Ref. No.</b> 40540 |  |
| <b>description</b> nut thread M8x1 Qty 10 pcs                                       |                        |                       |  |

## accessories

### nuts

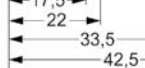
|   |                        |                       |  |
|---|------------------------|-----------------------|--|
|  |                        |                       |  |
| 1   | <b>Part No.</b> 102067 | <b>Ref. No.</b> 40540 |  |
| <b>description</b> nut thread M8x1 H 3mm brass Qty 1 pcs type SEF 1               |                        |                       |  |

|   |                        |                       |  |
|---|------------------------|-----------------------|--|
|  |                        |                       |  |
| 1   | <b>Part No.</b> 102500 | <b>Ref. No.</b> 40540 |  |
| <b>description</b> nut thread M8x1 Qty 10 pcs                                       |                        |                       |  |

|   |                        |                       |  |
|---|------------------------|-----------------------|--|
|  |                        |                       |  |
| 1   | <b>Part No.</b> 102067 | <b>Ref. No.</b> 40540 |  |
| <b>description</b> nut thread M8x1 H 3mm brass Qty 1 pcs type SEF 1                 |                        |                       |  |

|   |                        |                       |  |
|---|------------------------|-----------------------|--|
|  |                        |                       |  |
| 1   | <b>Part No.</b> 102500 | <b>Ref. No.</b> 40540 |  |
| <b>description</b> nut thread M8x1 Qty 10 pcs                                       |                        |                       |  |

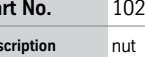
|   |                        |                       |  |
|---|------------------------|-----------------------|--|
|  |                        |                       |  |
| 1   | <b>Part No.</b> 102500 | <b>Ref. No.</b> 40540 |  |
| <b>description</b> nut thread M8x1 Qty 10 pcs                                       |                        |                       |  |



## gas burners

### hob burners

#### accessories

#### reducers for pan supports



1

|                    |   |                 |       |
|--------------------|---|-----------------|-------|
| <b>Part No.</b>    | 104499                                  | <b>Ref. No.</b> | 43158 |
| <b>description</b> | reducer for pan support L 175mm W 114mm |                 |       |

## gas nozzles

### main nozzles

#### gas nozzles M9x1



1

|                    |   |                 |       |
|--------------------|---|-----------------|-------|
| <b>Part No.</b>    | 107345                                      | <b>Ref. No.</b> | 43081 |
| <b>description</b> | gas injector thread M9x1 WS 10 bore ø 0.9mm |                 |       |



1

|                    |   |                 |       |
|--------------------|---|-----------------|-------|
| <b>Part No.</b>    | 107347                                      | <b>Ref. No.</b> | 43192 |
| <b>description</b> | gas injector thread M9x1 WS 10 bore ø 2.4mm |                 |       |

### pilot burner nozzles

#### pilot burner nozzles SIT

#### 140/150 series



1

|                    |  |                 |       |
|--------------------|--|-----------------|-------|
| <b>Part No.</b>    | 100204   | <b>Ref. No.</b> | 41007 |
| <b>description</b> | pilot burner nozzle SIT LPG code 14 bore ø 0.18/0.20mm Qty 1 pcs suitable for 140 series |                 |       |



1

|                    |  |                 |       |
|--------------------|--|-----------------|-------|
| <b>Part No.</b>    | 100207   | <b>Ref. No.</b> | 40292 |
| <b>description</b> | pilot burner nozzle SIT natural gas code 27 bore ø 0.40/0.38mm suitable for SIT 140 series |                 |       |

#### 160 series



1

|                    |   |                 |       |
|--------------------|---|-----------------|-------|
| <b>Part No.</b>    | 107650  | <b>Ref. No.</b> | 41009 |
| <b>description</b> | pilot burner nozzle SIT LPG code 30 Qty 1 pcs |                 |       |

## auxiliary gas parts

### screw connections

#### union screws



1

|                    |  |                 |       |
|--------------------|--|-----------------|-------|
| <b>Part No.</b>    | 100905                                       | <b>Ref. No.</b> | 42509 |
| <b>description</b> | locking screw M10x1 for pipe ø 6mm Qty 1 pcs |                 |       |

#### angle pieces



1

|                    |  |                 |       |
|--------------------|--|-----------------|-------|
| <b>Part No.</b>    | 104490   | <b>Ref. No.</b> | 43167 |
| <b>description</b> | angle piece T1: 1/2" IT T2: 1/2" ET grommet ø 13.5mm grommet length 22mm WS 24 brass |                 |       |



1

|                    |  |                 |       |
|--------------------|--|-----------------|-------|
| <b>Part No.</b>    | 104489   | <b>Ref. No.</b> | 43168 |
| <b>description</b> | angle piece T1: 3/4" IT T2: 1/2" ET grommet ø 13.5mm grommet length 22mm WS 24 brass |                 |       |

## tools

### reamers

#### reamer set



1

|                    |   |                 |       |
|--------------------|---|-----------------|-------|
| <b>Part No.</b>    | 800050  | <b>Ref. No.</b> | 70565 |
| <b>description</b> | nozzle reamers set size 0.5/0.6/0.7/0.8/0.9mm size 1 1.0/1.1/1.2/1.4/1.6/1.8/2.0mm 12-piece with holder                     |                 |       |
| <b>description</b> | reamer set with holder 12-piece 0.5mm / 0.6mm / 0.7mm / 0.8mm / 0.9mm / 1.0mm 1.1mm / 1.2mm / 1.4mm / 1.6mm / 1.8mm / 2.0mm |                 |       |



## equipment-specific units

## for ice-cube maker

## mechanics for evaporators

## gear motors

## motors



1

|   |   |                 |                   |
|---|---|-----------------|-------------------|
| <b>Part No.</b>   | 500793  | <b>Ref. No.</b> | 23735             |
| <b>description</b>  | motor with belt pulley 120W 230V 50/60Hz 1 phase shaft $\varnothing$ 10mm 1390/1600rpm type RM63/50 $\varnothing$ 90mm H 160mm REBO 0.12kW                                      |                 |                   |
| <b>spare parts for</b>  | 500793  |                 |                   |
|   | <b>Part No.</b>   | 695279          | <b>Ref. No.</b> — |
|  | round belt pulley disc $\varnothing$ 49mm single shaft intake $\varnothing$ 10mm groove depth 5mm disc width 12mm groove width 10mm overall width 19mm shaft $\varnothing$ 18mm |                 |                   |

## for espresso machines

## filter holders

## filter holders standard

## filter holder without spout



1

|                    |  |                 |     |
|--------------------|--|-----------------|-----|
| <b>Part No.</b>    | 525997   | <b>Ref. No.</b> | N/A |
| <b>description</b> | filter holder suitable for IBERITAL without outlet mounting $\varnothing$ 83mm hole $\varnothing$ 7.5mm outlet 3/8" ID $\varnothing$ 56.5mm wedge height 8mm wedge position horizontal number of wedges 3 lever inclined chrome-plated brass |                 |     |



1

|                    |   |                 |     |
|--------------------|---|-----------------|-----|
| <b>Part No.</b>    | 525998  | <b>Ref. No.</b> | N/A |
| <b>description</b> | filter holder suitable for IBERITAL without outlet mounting $\varnothing$ 83mm hole $\varnothing$ 7.5mm outlet 3/8" ID $\varnothing$ 62mm wedge height 10.2mm wedge position horizontal number of wedges 2 lever straight chrome-plated brass |                 |     |

## filter holders short



1

|                    |  |                 |       |
|--------------------|--|-----------------|-------|
| <b>Part No.</b>    | 525231   | <b>Ref. No.</b> | 19412 |
| <b>description</b> | filter holder mounting $\varnothing$ 83mm outlet 3/8" ID $\varnothing$ 56.5mm handle M12x1.75 wedge height 8mm wedge position horizontal number of wedges 2 lever inclined chrome-plated brass |                 |       |



1

|                    |   |                 |              |
|--------------------|---|-----------------|--------------|
| <b>Part No.</b>    | 525230  | <b>Ref. No.</b> | 2966<br>9699 |
| <b>description</b> | filter holder mounting $\varnothing$ 83mm outlet 3/8" ID $\varnothing$ 62mm handle M12x1.75 wedge height 10.2mm wedge position horizontal number of wedges 2 lever straight chrome-plated brass |                 |              |

## filters

## for 1 cup



1

|                    |   |                 |       |
|--------------------|---|-----------------|-------|
| <b>Part No.</b>    | 525234  | <b>Ref. No.</b> | 19786 |
| <b>description</b> | coffee filter $\varnothing$ 66mm mounting $\varnothing$ 55mm H 23mm cups 1 perforation $\varnothing$ 0.45mm |                 |       |



1

|                    |   |                 |       |
|--------------------|---|-----------------|-------|
| <b>Part No.</b>    | 525235  | <b>Ref. No.</b> | 19787 |
| <b>description</b> | coffee filter $\varnothing$ 66mm mounting $\varnothing$ 55mm H 25mm cups 1 perforation $\varnothing$ 0.45mm |                 |       |

## for 2 cups



1

|                    |   |                 |       |
|--------------------|---|-----------------|-------|
| <b>Part No.</b>    | 529030  | <b>Ref. No.</b> | 19788 |
| <b>description</b> | coffee filter $\varnothing$ 65mm mounting $\varnothing$ 55mm H 27.5mm cups 2 amount of coffee 14g |                 |       |



| blind filters      |  |                 |      |
|--------------------|--|-----------------|------|
|                    |  |                 |      |
| 1                  |  |                 |      |
| <b>Part No.</b>    | 525232   | <b>Ref. No.</b> | 6551 |
| <b>description</b> | blind filter ø 65mm mounting ø 55.2mm H 25.5mm |                 |      |

| with upstand       |                             |                 |     |
|--------------------|-----------------------------|-----------------|-----|
|                    |                             |                 |     |
| 1                  |                             |                 |     |
| <b>Part No.</b>    | 529132                      | <b>Ref. No.</b> | 288 |
| <b>description</b> | shower screen ø 58mm H 18mm |                 |     |

| brewing units      |  |                 |      |
|--------------------|--|-----------------|------|
| shower screens     |  |                 |      |
| flat               |  |                 |      |
|                    |  |                 |      |
| 1                  |  |                 |      |
| <b>Part No.</b>    | 529088                                 | <b>Ref. No.</b> | 2181 |
| <b>description</b> | shower screen ø 48mm hole ø 5.5mm flat |                 |      |

|                    |                                   |                 |      |
|--------------------|-----------------------------------|-----------------|------|
|                    |                                   |                 |      |
| 1                  |                                   |                 |      |
| <b>Part No.</b>    | 529084                            | <b>Ref. No.</b> | 1194 |
| <b>description</b> | shower screen ø 52mm hole ø 6.4mm |                 |      |

| with upstand and central hole |                                       |                 |       |
|-------------------------------|---------------------------------------|-----------------|-------|
|                               |                                       |                 |       |
| 1                             |                                       |                 |       |
| <b>Part No.</b>               | 525233                                | <b>Ref. No.</b> | 19079 |
| <b>description</b>            | shower screen ø 52mm H 5mm hole ø 5mm |                 |       |

|                    |                        |                 |        |
|--------------------|------------------------|-----------------|--------|
|                    |                        |                 |        |
| 1                  |                        |                 |        |
| <b>Part No.</b>    | 531287                 | <b>Ref. No.</b> | ID-103 |
| <b>description</b> | shower screen ø 57.5mm |                 |        |

| filter holder gaskets |  |                 |       |
|-----------------------|--|-----------------|-------|
| flat                  |  |                 |       |
| with internal notch   |  |                 |       |
|                       |  |                 |       |
| 1                     |  |                 |       |
| <b>Part No.</b>       | 525385   | <b>Ref. No.</b> | 19077 |
| <b>description</b>    | filter holder gasket inner cone D1 ø 73.5mm D2 ø 55.5mm H 10.5mm with inside notch Qty 1 pcs |                 |       |

| standard           |  |                 |     |
|--------------------|--|-----------------|-----|
|                    |  |                 |     |
| 1                  |  |                 |     |
| <b>Part No.</b>    | 528030   | <b>Ref. No.</b> | 142 |
| <b>description</b> | filter holder gasket D1 ø 72.7mm D2 ø 57.2mm H 8mm Qty 1 pcs |                 |     |

|                    |  |                 |      |
|--------------------|--|-----------------|------|
|                    |  |                 |      |
| 1                  |  |                 |      |
| <b>Part No.</b>    | 528060   | <b>Ref. No.</b> | 1280 |
| <b>description</b> | filter holder gasket D1 ø 73.5mm D2 ø 59.5mm H 7.5mm Qty 1 pcs |                 |      |

|                    |  |                 |              |
|--------------------|--|-----------------|--------------|
|                    |  |                 |              |
| 1                  |  |                 |              |
| <b>Part No.</b>    | 525607   | <b>Ref. No.</b> | 142<br>30260 |
| <b>description</b> | filter holder gasket D1 ø 73mm D2 ø 57mm H 8.2mm Qty 1 pcs |                 |              |





|   |  |                 |     |
|---|--|-----------------|-----|
|  |  |                 |     |
| 1   |  |                 |     |
| <b>Part No.</b>   | 525371   | <b>Ref. No.</b> | 145 |
| <b>description</b>  | filter holder gasket D1 ø 73mm D2 ø 57mm H 9.2mm Qty 1 pcs |                 |     |

## brewing units with solenoid valve

## filters

## filters

|   |                             |                 |       |
|---|-----------------------------|-----------------|-------|
|  |                             |                 |       |
| 1   |                             |                 |       |
| <b>Part No.</b>   | 526738                      | <b>Ref. No.</b> | 22042 |
| <b>description</b>  | filter set for brewing unit |                 |       |

## brewing units manual

## components

## gaskets

|   |   |                 |      |
|---|---|-----------------|------|
|  |   |                 |      |
| 1   |   |                 |      |
| <b>Part No.</b>   | 526856  | <b>Ref. No.</b> | 2243 |
| <b>description</b>  | gasket D1 ø 13mm ID ø 4mm thickness 4mm Viton |                 |      |

|   |  |                 |     |
|---|--|-----------------|-----|
|  |  |                 |     |
| 1   |  |                 |     |
| <b>Part No.</b>   | 525368   | <b>Ref. No.</b> | 172 |
| <b>description</b>  | gasket ED ø 13mm ID ø 4mm H 4mm Qty 1 pcs EPDM |                 |     |

|   |  |                 |     |
|---|--|-----------------|-----|
|  |  |                 |     |
| 1   |  |                 |     |
| <b>Part No.</b>   | 525369   | <b>Ref. No.</b> | 163 |
| <b>description</b>  | gasket ED ø 15.5mm ID ø 7.5mm H 4mm Qty 1 pcs EPDM |                 |     |

|   |   |                 |     |
|---|---|-----------------|-----|
|  |   |                 |     |
| 1   |   |                 |     |
| <b>Part No.</b>   | 525378  | <b>Ref. No.</b> | 449 |
| <b>description</b>  | gasket ED ø 15.5mm ID ø 7.5mm H 4mm Qty 1 pcs Viton |                 |     |

|   |  |                 |      |
|---|--|-----------------|------|
|  |  |                 |      |
| 1   |  |                 |      |
| <b>Part No.</b>   | 528494   | <b>Ref. No.</b> | 2243 |
| <b>description</b>  | gasket rubber ED ø 13mm ID ø 4mm thickness 4mm Qty 1 pcs |                 |      |

## miscellaneous

|   |  |                 |     |
|---|--|-----------------|-----|
|  |  |                 |     |
| 1   |  |                 |     |
| <b>Part No.</b>   | 528531   | <b>Ref. No.</b> | 216 |
| <b>description</b>  | bolt square brass thread M3 L 12mm W 6mm H 6mm thread L 10mm |                 |     |

## levers

## levers

|   |                    |                 |               |
|---|--------------------|-----------------|---------------|
|  |                    |                 |               |
| 1   |                    |                 |               |
| <b>Part No.</b>   | 525398             | <b>Ref. No.</b> | 21541<br>7090 |
| <b>description</b>  | lever for IBERITAL |                 |               |

## camshafts

|  |   |                 |             |
|--|---|-----------------|-------------|
|  |   |                 |             |
| 1  |   |                 |             |
| <b>Part No.</b>  | 525763  | <b>Ref. No.</b> | 151<br>2518 |
| <b>description</b>   | camshaft shaft ø 8mm shaft intake ø 10mm L 78.3mm W 19.6mm H 16.7mm thread M6 brass suitable for IBERITAL |                 |             |

## valves

|  |   |                 |     |
|--|---|-----------------|-----|
|  |   |                 |     |
| 1  |   |                 |     |
| <b>Part No.</b>  | 525761  | <b>Ref. No.</b> | 180 |
| <b>description</b>   | valve for brewing unit L 57.7mm round ED ø 16mm shaft ø 4mm |                 |     |



|   |   |                 |     |
|---|---|-----------------|-----|
|  |   |                 |     |
| 1   |   |                 |     |
| <b>Part No.</b>   | 525759  | <b>Ref. No.</b> | 178 |
| <b>description</b>  | valve for drain unit L 20.5mm ED ø 16mm shaft 5x5 |                 |     |

|   |  |                 |     |
|---|--|-----------------|-----|
|  |  |                 |     |
| 1   |  |                 |     |
| <b>Part No.</b>   | 525760   | <b>Ref. No.</b> | 179 |
| <b>description</b>  | valve for drain unit L 59.5mm square ED ø 16mm shaft 5x5 |                 |     |

components

nozzles

with thread

|   |  |                 |       |
|---|--|-----------------|-------|
|  |  |                 |       |
| 1   |  |                 |       |
| <b>Part No.</b>   | 526441                                   | <b>Ref. No.</b> | 21609 |
| <b>description</b>  | nozzle bore ø 0.5mm thread M6x0.75 L 9mm |                 |       |

|  |   |                 |     |
|--|---|-----------------|-----|
|  |   |                 |     |
| 1  |   |                 |     |
| <b>Part No.</b>  | 528486  | <b>Ref. No.</b> | 267 |
| <b>description</b>   | nozzle bore ø 0.7mm thread M6x0.75 L 9mm WS 7 |                 |     |

water dispersions

water dispersions

group 2

|   |   |                 |     |
|---|---|-----------------|-----|
|  |   |                 |     |
| 1   |   |                 |     |
| <b>Part No.</b>   | 525756  | <b>Ref. No.</b> | 175 |
| <b>description</b>  | water distributor ø 30mm hole ø 1.5mm H 15mm ET M10x1 grooves 6 2.6mm brass 2 holes perforation ø 1mm |                 |     |

|   |   |                 |       |
|---|---|-----------------|-------|
|  |   |                 |       |
| 1   |   |                 |       |
| <b>Part No.</b>   | 525757  | <b>Ref. No.</b> | 19449 |
| <b>description</b>  | water distributor ø 30mm hole ø 3mm H 14.5mm ET M10x1 IT M5 grooves 6 2.8mm brass 2 holes perforation ø 1mm |                 |       |

safety valves

safety valves

3/8"

|   |   |                 |      |
|---|---|-----------------|------|
|  |   |                 |      |
| 1   |   |                 |      |
| <b>Part No.</b>   | 529302  | <b>Ref. No.</b> | 3596 |
| <b>description</b>  | safety valve connection 3/8" triggering pressure 1.8bar |                 |      |

|   |   |                 |      |
|---|---|-----------------|------|
|  |   |                 |      |
| 1   |   |                 |      |
| <b>Part No.</b>   | 529312  | <b>Ref. No.</b> | 1314 |
| <b>description</b>  | safety valve connection 3/8" triggering pressure 1.8bar |                 |      |

expansion valves

gaskets

|  |  |                 |     |
|--|--|-----------------|-----|
|  |  |                 |     |
| 1  |  |                 |     |
| <b>Part No.</b>  | 526692   | <b>Ref. No.</b> | 160 |
| <b>description</b>   | gasket ED ø 15mm seat ø 6mm H 4mm overall height 9mm |                 |     |

drain pans

drain pans

|  |  |                 |      |
|--|--|-----------------|------|
|  |  |                 |      |
| 1  |  |                 |      |
| <b>Part No.</b>  | 525217   | <b>Ref. No.</b> | 9937 |
| <b>description</b>   | drain pan L 78mm W 70mm H 54mm hose ø 12mm suitable for IBERITAL |                 |      |

|  |   |                 |      |
|--|---|-----------------|------|
|  |   |                 |      |
| 1  |   |                 |      |
| <b>Part No.</b>  | 525214  | <b>Ref. No.</b> | 6000 |
| <b>description</b>   | drain pan L 85mm ø 65mm hose ø 19mm suitable for IBERITAL |                 |      |





|   |  |                 |       |
|---|--|-----------------|-------|
|  |  |                 |       |
| 1   |  |                 |       |
| <b>Part No.</b>   | 525216   | <b>Ref. No.</b> | 23891 |
| <b>description</b>  | drain pan L 90mm W 70mm H 43mm hole ø 27mm hose ø 12mm |                 |       |

## accessories

|   |                                      |                 |                       |
|---|--------------------------------------|-----------------|-----------------------|
|  |                                      |                 |                       |
| 1   |                                      |                 |                       |
| <b>Part No.</b>   | 525215                               | <b>Ref. No.</b> | 22116<br>9188<br>9435 |
| <b>description</b>  | drain hose L 290mm ID ø 6mm ED ø 9mm |                 |                       |

## aerators and air bleeders

|   |                         |                 |      |
|---|-------------------------|-----------------|------|
|  |                         |                 |      |
| 1   |                         |                 |      |
| <b>Part No.</b>   | 529326                  | <b>Ref. No.</b> | 3319 |
| <b>description</b>  | aerator and air bleeder |                 |      |

|   |   |                 |      |
|---|---|-----------------|------|
|  |   |                 |      |
| 1   |   |                 |      |
| <b>Part No.</b>   | 529303  | <b>Ref. No.</b> | 3319 |
| <b>description</b>  | aerator and air bleeder connection 1/4" only steam  |                 |      |
| <b>spare parts for</b>  | 529303  |                 |      |
|  |   |                 |      |
| <b>Part No.</b>   | 528687  | <b>Ref. No.</b> | —    |
| <b>description</b>  | O-ring Viton thickness 1.78mm ID ø 3.69mm Qty 1 pcs |                 |      |

## boilers

## pipes

|   |  |                 |      |
|---|--|-----------------|------|
|  |  |                 |      |
| 1   |  |                 |      |
| <b>Part No.</b>   | 525762   | <b>Ref. No.</b> | 9242 |
| <b>description</b>  | aspiration tube tube ø 8mm pipe length 135mm T1: 1/4" T2: 1/4" copper conical seal |                 |      |

## steam/water taps

## steam/water taps

## steam/water taps

|  |  |                 |       |
|--|--|-----------------|-------|
|  |  |                 |       |
| 1  |  |                 |       |
| <b>Part No.</b>  | 525389   | <b>Ref. No.</b> | 11300 |
| <b>description</b>   | steam/water tap swing lever inlet 1/4" outlet 3/8" suitable for IBERITAL |                 |       |

## steam taps

## steam taps (complete)

|   |  |                 |       |
|---|--|-----------------|-------|
|  |  |                 |       |
| 1   |  |                 |       |
| <b>Part No.</b>   | 525392   | <b>Ref. No.</b> | 11017 |
| <b>description</b>  | steam tap with steam pipe inlet 1/4" suitable for IBERITAL |                 |       |

## components

## gaskets

|   |   |                 |      |
|---|---|-----------------|------|
|  |   |                 |      |
| 1   |   |                 |      |
| <b>Part No.</b>   | 526856  | <b>Ref. No.</b> | 2243 |
| <b>description</b>  | gasket D1 ø 13mm ID ø 4mm thickness 4mm Viton |                 |      |

## gasket supports

|  |                                   |                 |      |
|--|-----------------------------------|-----------------|------|
|  |                                   |                 |      |
| 1  |                                   |                 |      |
| <b>Part No.</b>  | 525175                            | <b>Ref. No.</b> | 1973 |
| <b>description</b>   | valve ø hexagon 16mm L 14mm brass |                 |      |



valve bodies



1

|                    |                                 |                 |      |
|--------------------|---------------------------------|-----------------|------|
| <b>Part No.</b>    | 525764                          | <b>Ref. No.</b> | 6783 |
| <b>description</b> | valve body for steam-/water-tap |                 |      |

water taps

water taps



1

|                    |  |                 |       |
|--------------------|--|-----------------|-------|
| <b>Part No.</b>    | 525391   | <b>Ref. No.</b> | 11277 |
| <b>description</b> | water tap with pipe inlet 1/4" suitable for IBERITAL |                 |       |

steam/water pipes

steam pipes



1

|                    |  |                 |      |
|--------------------|--|-----------------|------|
| <b>Part No.</b>    | 525396   | <b>Ref. No.</b> | 8302 |
| <b>description</b> | steam pipe thread 3/8" H 175mm L 210mm $\varnothing$ 14.2mm tube $\varnothing$ 10mm suitable for FAEMA |                 |      |



1

|                    |   |                 |       |
|--------------------|---|-----------------|-------|
| <b>Part No.</b>    | 525395  | <b>Ref. No.</b> | 19084 |
| <b>description</b> | steam pipe thread 3/8" H 225mm L 255mm $\varnothing$ 14.2mm tube $\varnothing$ 10mm suitable for IBERITAL |                 |       |

water pipes



1

|                    |  |                 |       |
|--------------------|--|-----------------|-------|
| <b>Part No.</b>    | 525397   | <b>Ref. No.</b> | 19085 |
| <b>description</b> | water pipe thread 3/8" $\varnothing$ 14.2mm L 65mm suitable for IBERITAL |                 |       |

accessories

bushes



1

|                    |        |                 |      |
|--------------------|--------|-----------------|------|
| <b>Part No.</b>    | 528786 | <b>Ref. No.</b> | 7506 |
| <b>description</b> | bush   |                 |      |



1

|                    |  |                 |       |
|--------------------|--|-----------------|-------|
| <b>Part No.</b>    | 525324   | <b>Ref. No.</b> | 19051 |
| <b>description</b> | bush D1 $\varnothing$ 14.3mm D2 $\varnothing$ 11.4mm H 6mm PTFE ID $\varnothing$ 7.1mm |                 |       |



1

|                    |   |                 |      |
|--------------------|---|-----------------|------|
| <b>Part No.</b>    | 525357  | <b>Ref. No.</b> | 7321 |
| <b>description</b> | bush D1 $\varnothing$ 15mm D2 $\varnothing$ 10.4mm H 10.3mm PTFE ID $\varnothing$ 7.6mm |                 |      |

tube handles



1

|                    |  |                 |       |
|--------------------|--|-----------------|-------|
| <b>Part No.</b>    | 525152   | <b>Ref. No.</b> | 10493 |
| <b>description</b> | handle for pipe $\varnothing$ 10mm L 40mm rubber |                 |       |

fine filters

fine filters



1

|                    |  |                 |              |
|--------------------|--|-----------------|--------------|
| <b>Part No.</b>    | 529911                                       | <b>Ref. No.</b> | 10971<br>263 |
| <b>description</b> | fine filter flat $\varnothing$ 11mm H 0.25mm |                 |              |



1

|                    |   |                 |      |
|--------------------|---|-----------------|------|
| <b>Part No.</b>    | 528946                                      | <b>Ref. No.</b> | 5232 |
| <b>description</b> | fine filter pipe $\varnothing$ 8.5mm H 22mm |                 |      |

## intake valves

## intake valves



1

|                 |        |                 |       |
|-----------------|--------|-----------------|-------|
| <b>Part No.</b> | 525394 | <b>Ref. No.</b> | 19065 |
|-----------------|--------|-----------------|-------|

**description** intake valve centre for IBERITAL



1

|                 |        |                 |       |
|-----------------|--------|-----------------|-------|
| <b>Part No.</b> | 525390 | <b>Ref. No.</b> | 10001 |
|-----------------|--------|-----------------|-------|

**description** intake valve front for IBERITAL



1

|                 |        |                 |       |
|-----------------|--------|-----------------|-------|
| <b>Part No.</b> | 525393 | <b>Ref. No.</b> | 11646 |
|-----------------|--------|-----------------|-------|

**description** intake valve rear for IBERITAL

## accessories

## bushes



1

|                 |        |                 |      |
|-----------------|--------|-----------------|------|
| <b>Part No.</b> | 525758 | <b>Ref. No.</b> | 4075 |
|-----------------|--------|-----------------|------|

**description** bush for filling valve D1 ø 15mm int. ø 1 12.9mm int. ø 2 10.8mm H 12.8mm brass

## gaskets



1

|                 |        |                 |     |
|-----------------|--------|-----------------|-----|
| <b>Part No.</b> | 528596 | <b>Ref. No.</b> | 316 |
|-----------------|--------|-----------------|-----|

**description** gasket ED ø 12mm ID ø 4mm overall height 4mm conical

## level glasses

## level glasses

## gaskets



1

|                 |        |                 |       |
|-----------------|--------|-----------------|-------|
| <b>Part No.</b> | 525379 | <b>Ref. No.</b> | 19794 |
|-----------------|--------|-----------------|-------|

**description** gasket D1 ø 15mm D2 ø 10mm ID ø 6mm

## pressure rings



1

|                 |        |                 |      |
|-----------------|--------|-----------------|------|
| <b>Part No.</b> | 525238 | <b>Ref. No.</b> | 2501 |
|-----------------|--------|-----------------|------|

**description** press ring D1 ø 15mm D2 ø 11.5mm thickness 1.5mm brass for level glass

## level glass pipes



1

|                 |        |                 |      |
|-----------------|--------|-----------------|------|
| <b>Part No.</b> | 525218 | <b>Ref. No.</b> | 9602 |
|-----------------|--------|-----------------|------|

**description** water level tube ø 11mm H 140mm ID ø 6.5mm marking Min/Max red/blue



1

|                 |        |                 |    |
|-----------------|--------|-----------------|----|
| <b>Part No.</b> | 529351 | <b>Ref. No.</b> | 95 |
|-----------------|--------|-----------------|----|

**description** water level tube ø 12mm H 135mm

## non-return valves

## balls



1

|                 |        |                 |     |
|-----------------|--------|-----------------|-----|
| <b>Part No.</b> | 528419 | <b>Ref. No.</b> | 158 |
|-----------------|--------|-----------------|-----|

**description** ball ø 11mm SS

## for coffee grinders

## grinding burrs

## grinding burrs conical



1

|                 |        |                 |     |
|-----------------|--------|-----------------|-----|
| <b>Part No.</b> | 526890 | <b>Ref. No.</b> | 709 |
|-----------------|--------|-----------------|-----|

**description** grinding burrs pair turn direction right D1 ø 38mm D2 ø 30mm H 18/20mm shaft ø 7mm suitable for IBERITAL

## miscellaneous



1

|                 |        |                 |       |
|-----------------|--------|-----------------|-------|
| <b>Part No.</b> | 530534 | <b>Ref. No.</b> | 14572 |
|-----------------|--------|-----------------|-------|

**description** equipment foot rectangular L 30mm plastic for coffee grinder



dosing containers

dosing container lids

|   |                                  |                 |      |
|---|----------------------------------|-----------------|------|
|  |                                  |                 |      |
| 1   |                                  |                 |      |
| <b>Part No.</b>   | 527458                           | <b>Ref. No.</b> | 4186 |
| <b>description</b>  | lid for dosing container ø 126mm |                 |      |

automatic grinding

automatic grinding

|   |  |                 |       |
|---|--|-----------------|-------|
|  |  |                 |       |
| 1   |  |                 |       |
| <b>Part No.</b>   | 698757                                 | <b>Ref. No.</b> | 23621 |
| <b>description</b>  | housing for microswitch H 26mm L 102mm |                 |       |
| <b>accessories for</b>  | 698757                                 |                 |       |
|   | <b>Part No.</b>                        | <b>Ref. No.</b> |       |
|  | 698756                                 | 23620           |       |
|   | lid for microswitch H 20mm             |                 |       |

|   |                            |                 |       |
|---|----------------------------|-----------------|-------|
|  |                            |                 |       |
| 1   |                            |                 |       |
| <b>Part No.</b>   | 698756                     | <b>Ref. No.</b> | 23620 |
| <b>description</b>  | lid for microswitch H 20mm |                 |       |

miscellaneous



|   |   |                 |      |
|---|---|-----------------|------|
|  |   |                 |      |
| 1   |   |                 |      |
| <b>Part No.</b>   | 526541  | <b>Ref. No.</b> | 8161 |
| <b>description</b>  | frame for lid L 73.5mm W 44mm H 8mm mounting pos. lower plastic |                 |      |

support for filter holder

|   |  |                 |      |
|---|--|-----------------|------|
|  |  |                 |      |
| 1   |  |                 |      |
| <b>Part No.</b>   | 527891   | <b>Ref. No.</b> | 5854 |
| <b>description</b>  | filter holder support for dosing unit L 71mm W 98mm H 25mm plastic |                 |      |

for dishwashers

air traps

|   |  |                 |       |
|---|--|-----------------|-------|
|  |  |                 |       |
| 1   |  |                 |       |
| <b>Part No.</b>   | 517171   | <b>Ref. No.</b> | 16147 |
| <b>description</b>  | air trap L 90mm W 55mm H 31mm  |                 |       |
| <b>accessories for</b>  | 517171   |                 |       |
|   | <b>Part No.</b>  | <b>Ref. No.</b> |       |
|  | 517173   | —               |       |
|   | flat gasket FIBER ED ø 14mm ID ø 8mm thickness 1.5mm Qty 1 pcs           |                 |       |
|   | <b>Part No.</b>  | <b>Ref. No.</b> |       |
|  | 517174   | —               |       |
|   | nut thread M8 H 6.5mm WS 13 SS DIN/ISO DIN 934 / ISO 4032/8673 Qty 1 pcs |                 |       |

door mechanics

miscellaneous

|   |                    |                 |      |
|---|--------------------|-----------------|------|
|  |                    |                 |      |
| 1   |                    |                 |      |
| <b>Part No.</b>   | 528224             | <b>Ref. No.</b> | 3163 |
| <b>description</b>  | gasket PTFE gasket |                 |      |

washing and rinsing systems

|  |                   |                 |      |
|--|-------------------|-----------------|------|
|  |                   |                 |      |
| 1  |                   |                 |      |
| <b>Part No.</b>  | 505040            | <b>Ref. No.</b> | 6277 |
| <b>description</b>   | bush for wash arm |                 |      |

|  |        |                 |       |
|--|--------|-----------------|-------|
|  |        |                 |       |
| 1  |        |                 |       |
| <b>Part No.</b>  | 517103 | <b>Ref. No.</b> | 16152 |
| <b>description</b>   | cover  |                 |       |



## knobs

### steam/water taps

#### steam/water taps



1

|                    |                                     |                 |      |
|--------------------|-------------------------------------|-----------------|------|
| <b>Part No.</b>    | 111109                              | <b>Ref. No.</b> | 2163 |
| <b>description</b> | knob ø 46mm shaft ø lead: 2mm black |                 |      |



1

|                    |                                    |                 |      |
|--------------------|------------------------------------|-----------------|------|
| <b>Part No.</b>    | 111372                             | <b>Ref. No.</b> | 9468 |
| <b>description</b> | knob ø 50mm L 32mm shaft 8mm black |                 |      |

### knob dial plates



1

|                    |  |                 |      |
|--------------------|--|-----------------|------|
| <b>Part No.</b>    | 111376   | <b>Ref. No.</b> | 9472 |
| <b>description</b> | knob dial plate for water filling ø 24mm black |                 |      |

## handles and hand wheels

### miscellaneous



1

|                    |  |                 |       |
|--------------------|--|-----------------|-------|
| <b>Part No.</b>    | 111373   | <b>Ref. No.</b> | 10930 |
| <b>description</b> | handle for sliding valve shaft ø 6x5mm black suitable for IBERITAL |                 |       |

### accessories



1

|                    |   |                 |       |
|--------------------|---|-----------------|-------|
| <b>Part No.</b>    | 525213  | <b>Ref. No.</b> | 11010 |
| <b>description</b> | bezel for sliding valve steam suitable for IBERITAL |                 |       |

|                    |   |                 |       |
|--------------------|---|-----------------|-------|
|                    |   |                 |       |
| 1                  |   |                 |       |
| <b>Part No.</b>    | 525399  | <b>Ref. No.</b> | 11009 |
| <b>description</b> | bezel for sliding valve water suitable for IBERITAL |                 |       |

## hinges

### oven hinges

|                    |   |                 |       |
|--------------------|---|-----------------|-------|
|                    |   |                 |       |
| 1                  |   |                 |       |
| <b>Part No.</b>    | 701137  | <b>Ref. No.</b> | 43037 |
| <b>description</b> | cover mounting distance 95mm L 112mm W 26mm thickness 1mm cut-out 9x66mm for oven hinge |                 |       |

|                    |   |                 |       |
|--------------------|---|-----------------|-------|
|                    |   |                 |       |
| 1                  |   |                 |       |
| <b>Part No.</b>    | 701135  | <b>Ref. No.</b> | 43033 |
| <b>description</b> | opposite support mounting distance 94mm L 110mm W 19mm for oven hinge |                 |       |

|                    |   |                 |       |
|--------------------|---|-----------------|-------|
|                    |   |                 |       |
| 1                  |   |                 |       |
| <b>Part No.</b>    | 701134  | <b>Ref. No.</b> | 43032 |
| <b>description</b> | oven hinge mounting distance 173mm mounting distance 2mm lug mounting 14mm lever length 123mm groove distance 10mm spring thickness 3.5mm mounting ear position left/right spring length 112mm L 207mm W 25mm |                 |       |



**gaskets**

**O-rings**

**EPDM**

1

|                    |  |                 |     |
|--------------------|--|-----------------|-----|
| <b>Part No.</b>    | 525310   | <b>Ref. No.</b> | 330 |
| <b>description</b> | O-ring EPDM thickness 1.9mm ID ø 4.2mm Qty 1 pcs |                 |     |

1

|                    |   |                 |       |
|--------------------|---|-----------------|-------|
| <b>Part No.</b>    | 529251  | <b>Ref. No.</b> | 19426 |
| <b>description</b> | O-ring EPDM thickness 2.62mm ID ø 15.08mm Qty 1 pcs |                 |       |

1

|                    |  |                 |      |
|--------------------|--|-----------------|------|
| <b>Part No.</b>    | 528583   | <b>Ref. No.</b> | 1293 |
| <b>description</b> | O-ring EPDM thickness 2.62mm ID ø 9.13mm Qty 1 pcs |                 |      |

1

|                    |   |                 |     |
|--------------------|---|-----------------|-----|
| <b>Part No.</b>    | 510951  | <b>Ref. No.</b> | 176 |
| <b>description</b> | O-ring EPDM thickness 3.53mm ID ø 18.64mm Qty 1 pcs |                 |     |

**silicone**

1

|                    |  |                 |      |
|--------------------|--|-----------------|------|
| <b>Part No.</b>    | 525388   | <b>Ref. No.</b> | 2350 |
| <b>description</b> | O-ring silicone thickness 1.78mm ID ø 9.25mm Qty 1 pcs |                 |      |

1

|                    |  |                 |      |
|--------------------|--|-----------------|------|
| <b>Part No.</b>    | 525384   | <b>Ref. No.</b> | 2179 |
| <b>description</b> | O-ring silicone thickness 1.9mm ID ø 4.2mm Qty 1 pcs |                 |      |

1

|                    |   |                 |      |
|--------------------|---|-----------------|------|
| <b>Part No.</b>    | 528222  | <b>Ref. No.</b> | 1019 |
| <b>description</b> | O-ring silicone thickness 2.62mm ID ø 10.78mm Qty 1 pcs |                 |      |

**Viton**

1

|                    |   |                 |      |
|--------------------|---|-----------------|------|
| <b>Part No.</b>    | 528226  | <b>Ref. No.</b> | 1287 |
| <b>description</b> | O-ring Viton thickness 2.62mm ID ø 9.92mm Qty 1 pcs |                 |      |

1

|                    |  |                 |       |
|--------------------|--|-----------------|-------|
| <b>Part No.</b>    | 528525   | <b>Ref. No.</b> | 10242 |
| <b>description</b> | O-ring Viton thickness 3.53mm ID ø 18.64mm Qty 1 pcs |                 |       |

**sealing washers**

**rubber gaskets**

1

|                    |  |                 |      |
|--------------------|--|-----------------|------|
| <b>Part No.</b>    | 528494   | <b>Ref. No.</b> | 2243 |
| <b>description</b> | gasket rubber ED ø 13mm ID ø 4mm thickness 4mm Qty 1 pcs |                 |      |

**copper gaskets**

**DIN-7603-A**

1

|                    |  |                 |      |
|--------------------|--|-----------------|------|
| <b>Part No.</b>    | 525386   | <b>Ref. No.</b> | 1565 |
| <b>description</b> | flat gasket copper ED ø 26mm ID ø 21mm thickness 1mm Qty 1 pcs |                 |      |

**DIN-7603-C**

1

|                    |   |                 |     |
|--------------------|---|-----------------|-----|
| <b>Part No.</b>    | 528520  | <b>Ref. No.</b> | 270 |
| <b>description</b> | gasket copper ED ø 22mm ID ø 16mm thickness 2mm |                 |     |







|   |   |                 |       |
|---|---|-----------------|-------|
|  |   |                 |       |
| 1   |   |                 |       |
| <b>Part No.</b>   | 525381  | <b>Ref. No.</b> | 10622 |
| <b>description</b>  | gasket copper ED ø 27mm ID ø 21mm thickness 3mm Qty 1 pcs |                 |       |

## PTFE gaskets

|   |   |                 |       |
|---|---|-----------------|-------|
|  |   |                 |       |
| 1   |   |                 |       |
| <b>Part No.</b>   | 525380  | <b>Ref. No.</b> | 11345 |
| <b>description</b>  | flat gasket PTFE ED ø 14mm ID ø 9.5mm thickness 0.5mm Qty 1 pcs |                 |       |

|   |  |                 |       |
|---|--|-----------------|-------|
|  |  |                 |       |
| 1   |  |                 |       |
| <b>Part No.</b>   | 526661   | <b>Ref. No.</b> | 10002 |
| <b>description</b>  | flat gasket PTFE ED ø 17mm ID ø 13mm thickness 2mm Qty 1 pcs |                 |       |

|   |  |                 |              |
|---|--|-----------------|--------------|
|  |  |                 |              |
| 1   |  |                 |              |
| <b>Part No.</b>   | 525611   | <b>Ref. No.</b> | 4216<br>9559 |
| <b>description</b>  | flat gasket PTFE ED ø 22mm ID ø 17mm thickness 2mm Qty 1 pcs |                 |              |

|   |  |                 |      |
|---|--|-----------------|------|
|  |  |                 |      |
| 1   |  |                 |      |
| <b>Part No.</b>   | 528683   | <b>Ref. No.</b> | 4215 |
| <b>description</b>  | flat gasket PTFE ED ø 26mm ID ø 21mm thickness 2mm Qty 1 pcs suitable for GAGGIA, SPAZIALE |                 |      |

|   |  |                 |      |
|---|--|-----------------|------|
|  |  |                 |      |
| 1   |  |                 |      |
| <b>Part No.</b>   | 528918   | <b>Ref. No.</b> | 4199 |
| <b>description</b>  | flat gasket PTFE ED ø 36mm ID ø 30mm thickness 2mm Qty 1 pcs suitable for VIBIEMME |                 |      |

## special gaskets

## group gaskets

|   |  |                 |      |
|---|--|-----------------|------|
|  |  |                 |      |
| 1   |  |                 |      |
| <b>Part No.</b>   | 525377   | <b>Ref. No.</b> | 9193 |
| <b>description</b>  | group gasket L 77mm W 66mm thickness 2mm aperture 24x6mm fibre |                 |      |

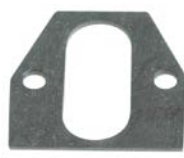
|  |  |                 |      |
|--|--|-----------------|------|
|  |  |                 |      |
| 1  |  |                 |      |
| <b>Part No.</b>  | 528943   | <b>Ref. No.</b> | 7685 |
| <b>description</b>   | group gasket L 77mm W 74mm thickness 2mm aperture 27x66mm hole distance 56mm fibre |                 |      |

## springs

## compression springs

|  |  |                 |       |
|--|--|-----------------|-------|
|  |  |                 |       |
| 1  |  |                 |       |
| <b>Part No.</b>  | 525359   | <b>Ref. No.</b> | 10415 |
| <b>description</b>   | compression spring ø 10.7mm L 30mm wire gauge ø 1.2mm windings 8 |                 |       |

|  |  |                 |       |
|--|--|-----------------|-------|
|  |  |                 |       |
| 1  |  |                 |       |
| <b>Part No.</b>  | 525360   | <b>Ref. No.</b> | 11050 |
| <b>description</b>   | compression spring ø 11.5mm L 26mm wire gauge ø 2mm windings 7 |                 |       |

|  |  |                 |     |
|--|--|-----------------|-----|
|  |  |                 |     |
| 1  |  |                 |     |
| <b>Part No.</b>  | 525370   | <b>Ref. No.</b> | 248 |
| <b>description</b>   | compression spring ø 13.5mm L 40.5mm wire gauge ø 1.1mm windings 7 |                 |     |

|  |  |                 |     |
|--|--|-----------------|-----|
|  |  |                 |     |
| 1  |  |                 |     |
| <b>Part No.</b>  | 525236   | <b>Ref. No.</b> | 156 |
| <b>description</b>   | compression spring ø 14.5mm L 31.5mm wire gauge ø 2mm windings 7 |                 |     |

|  |  |                 |     |
|--|--|-----------------|-----|
|  |  |                 |     |
| 1  |  |                 |     |
| <b>Part No.</b>  | 525372   | <b>Ref. No.</b> | 162 |
| <b>description</b>   | compression spring ø 15mm L 27.5mm wire gauge ø 1.8mm windings 4 |                 |     |

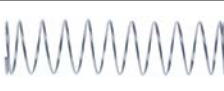
|  |  |                 |     |
|--|--|-----------------|-----|
|  |  |                 |     |
| 1  |  |                 |     |
| <b>Part No.</b>  | 525361   | <b>Ref. No.</b> | 148 |
| <b>description</b>   | compression spring ø 8.3mm L 32mm wire gauge ø 0.4mm windings 10 |                 |     |





## coffee accessories

### supports for filter holders

|   |  |                 |   |
|---|--|-----------------|---|
|  |  |                 |   |
| 1   |  |                 |   |
| <b>Part No.</b>   | 531293   | <b>Ref. No.</b> | — |
| <b>description</b>  | bracket for filter holder W 90mm D 70mm H 65mm SS/rubber |                 |   |

## manometers

|   |   |                 |      |
|---|---|-----------------|------|
|  |   |                 |      |
| 1   |   |                 |      |
| <b>Part No.</b>   | 541763  | <b>Ref. No.</b> | 9679 |
| <b>description</b>  | manometer double scale ø 58mm pressure range 0-2.5 / 0-16bar connection on the backside thread 1/8" |                 |      |

|  |   |                 |       |
|--|---|-----------------|-------|
|  |   |                 |       |
| 1  |   |                 |       |
| <b>Part No.</b>  | 541223  | <b>Ref. No.</b> | 21731 |
| <b>description</b>   | manometer double scale ø 60mm pressure range 0-2.5 / 0-16bar connection on the backside thread 1/8" |                 |       |

|   |  |                 |       |
|---|--|-----------------|-------|
|  |  |                 |       |
| 1   |  |                 |       |
| <b>Part No.</b>   | 541764   | <b>Ref. No.</b> | 11267 |
| <b>description</b>  | manometer ø 39mm pressure range 0-16bar thread 1/8" marking 8-9 connection on the backside |                 |       |

|   |   |                 |       |
|---|---|-----------------|-------|
|  |   |                 |       |
| 1   |   |                 |       |
| <b>Part No.</b>   | 525375  | <b>Ref. No.</b> | 11268 |
| <b>description</b>  | manometer ø 39mm pressure range 0-3bar thread 1/8" marking 0.8-1 connection on the backside |                 |       |

|  |  |                 |       |
|--|--|-----------------|-------|
|  |  |                 |       |
| 1  |  |                 |       |
| <b>Part No.</b>  | 525645   | <b>Ref. No.</b> | 24976 |
| <b>description</b>   | manometer ø 57mm pressure range 0-16bar CARIMALI connection 1/8" |                 |       |

|  |  |                 |       |
|--|--|-----------------|-------|
|  |  |                 |       |
| 1  |  |                 |       |
| <b>Part No.</b>  | 525644   | <b>Ref. No.</b> | 24975 |
| <b>description</b>   | manometer ø 57mm pressure range 0-2.5bar without glass connection 1/8" |                 |       |

## dosing pumps

### membrane dosing pumps



#### self-priming

#### LANG

|   |   |  |                 |
|---|---|--|-----------------|
|  |   |  |                 |
| 1   |   |  |                 |
| <b>Part No.</b>   | 361221  | <b>Ref. No.</b>  | 4211            |
| <b>description</b>  | dosing pump type N6 rinse aid pressure connection ø 4x6mm suction connection ø 6x8mm LANG |  |                 |
| <b>spare parts for</b>  | 361221  |  |                 |
|  | <b>Part No.</b>   | 361079   | <b>Ref. No.</b> |
|   |   |  | —               |
|   |   | spring for type N5/N6 for ball                           |                 |
|  | <b>Part No.</b>   | 361080   | <b>Ref. No.</b> |
|   |   |  | —               |
|   |   | O-ring EPDM thickness 2mm ID ø 16mm Qty 1 pcs            |                 |
|  | <b>Part No.</b>   | 361085   | <b>Ref. No.</b> |
|   |   |  | —               |
|   |   | O-ring EPDM thickness 2mm ID ø 8mm Qty 1 pcs             |                 |
|  | <b>Part No.</b>   | 361309   | <b>Ref. No.</b> |
|   |   |  | —               |
|   |   | ball for type N5/N6                                      |                 |
|  | <b>Part No.</b>   | 361310   | <b>Ref. No.</b> |
|   |   |  | —               |
|   |   | bracket for type N6 ball guide                           |                 |
|  | <b>Part No.</b>   | 361311   | <b>Ref. No.</b> |
|   |   |  | —               |
|   |   | O-ring EPDM thickness 2mm ID ø 6mm Qty 1 pcs for type N6 |                 |
|  | <b>Part No.</b>   | 361314   | <b>Ref. No.</b> |
|   |   |  | —               |
|   |   | valve ring for type N6 holder for O-ring                 |                 |

Table continues overleaf



|   |  |        |            |
|---|--|--------|------------|
| spare parts for   | 361221   |        |            |
|  | <b>Part No.</b>  | 361317 | Ref. No. — |
|   | sealing disc for type N6                                   |        |            |
|  | <b>Part No.</b>  | 361886 | Ref. No. — |
|   | non-return valve inletmm outletmm outlet ø 12.4mm L 12.7mm |        |            |
|  | <b>Part No.</b>  | 505228 | Ref. No. — |
|   | spacer bush ID ø 4.5mm ED ø 10mm L 16mm for dosing pump    |        |            |

## hoses

### supply hoses

#### stainless steel flexi hoses

#### universal hoses

1





|                    |   |                 |     |
|--------------------|---|-----------------|-----|
| <b>Part No.</b>    | 520602  | <b>Ref. No.</b> | 351 |
| <b>description</b> | flex hose SS braid straight-straight DN8 connections 3/8" L 1500mm conical seal approval DVGW operating p. 10bar test pressure 32bar burst p. 95bar |                 |     |

1

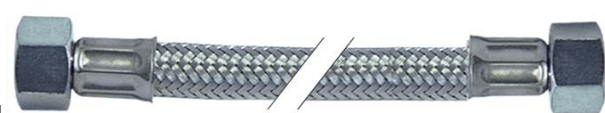

|                    |  |                 |      |
|--------------------|--|-----------------|------|
| <b>Part No.</b>    | 520572   | <b>Ref. No.</b> | 3052 |
| <b>description</b> | flex hose SS braid straight-straight DN8 connections 3/8" L 500mm conical seal approval DVGW operating p. 10bar test pressure 32bar burst p. 95bar |                 |      |



1



|                    |  |                 |        |
|--------------------|--|-----------------|--------|
| <b>Part No.</b>    | 520600   | <b>Ref. No.</b> | 520600 |
| <b>description</b> | flex hose SS braid straight-straight DN8 connections 3/8" L 750mm conical seal approval DVGW operating p. 10bar test pressure 32bar burst p. 95bar |                 |        |

## industrial hoses

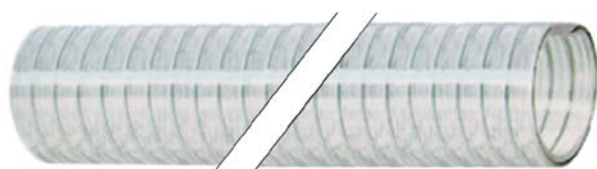
### hoses wire reinforced



1

|                    |   |                 |      |
|--------------------|---|-----------------|------|
| <b>Part No.</b>    | 520489  | <b>Ref. No.</b> | 7074 |
| <b>description</b> | drain hose ID ø 14mm ED ø 20mm L 1.5m wire reinforced |                 |      |

## fittings, hose and pipe connectors

### hose connectors

#### without screw connection

1

|                    |                                  |                 |       |
|--------------------|----------------------------------|-----------------|-------|
| <b>Part No.</b>    | 510843                           | <b>Ref. No.</b> | 22975 |
| <b>description</b> | T-piece plastic hose ø 10-6-10mm |                 |       |

## fittings

### double nipples

1

|                    |  |                 |     |
|--------------------|--|-----------------|-----|
| <b>Part No.</b>    | 520164   | <b>Ref. No.</b> | 959 |
| <b>description</b> | double nipple nickel-plated brass thread 1/4" - 3/8" Qty 1 pcs |                 |     |

## valves and tank inlets

### ball valves

#### universal

#### mini ball valves

1

|                    |   |                 |      |
|--------------------|---|-----------------|------|
| <b>Part No.</b>    | 520723  | <b>Ref. No.</b> | 8263 |
| <b>description</b> | ball valve connection 3/8" IT - 3/8" ET DN8 total length 40mm brass |                 |      |



tools

machining

reamers

reamer set

|   |  |                 |       |
|---|--|-----------------|-------|
|  |  |                 |       |
| 1   |  |                 |       |
| <b>Part No.</b>   | 800050   | <b>Ref. No.</b> | 70565 |
| <b>description</b>  | nozzle reamers set size 0.5/0.6/0.7/0.8/0.9mm size 1<br>1.0/1.1/1.2/1.4/1.6/1.8/2.0mm 12-piece with holder |                 |       |
| <b>description</b>  |  |                 |       |

fastening material

screws

hexagonal screws

|   |   |                 |       |
|---|---|-----------------|-------|
|  |   |                 |       |
| 1   |   |                 |       |
| <b>Part No.</b>   | 560085  | <b>Ref. No.</b> | 11270 |
| <b>description</b>  | hexagonal screw thread M5 thread L 20mm SS WS 8 Qty 20 pcs DIN 933 / ISO 4017 |                 |       |

nuts

hexagonal nuts

hexagonal nuts metric (without norm)

|   |  |                 |       |
|---|--|-----------------|-------|
|  |  |                 |       |
| 1   |  |                 |       |
| <b>Part No.</b>   | 102067   | <b>Ref. No.</b> | 40540 |
| <b>description</b>  | nut thread M8x1 H 3mm brass Qty 1 pcs type SEF 1 |                 |       |

washers

washers

miscellaneous

|   |  |                 |      |
|---|--|-----------------|------|
|  |  |                 |      |
| 1   |  |                 |      |
| <b>Part No.</b>   | 525382   | <b>Ref. No.</b> | 8978 |
| <b>description</b>  | plain washer ID ø 14.5mm ED ø 18.5mm thickness 1.5mm Qty 1 pcs |                 |      |

|   |   |                 |       |
|---|---|-----------------|-------|
|  |   |                 |       |
| 1   |   |                 |       |
| <b>Part No.</b>   | 525383  | <b>Ref. No.</b> | 21582 |
| <b>description</b>  | plain washer ID ø 7mm ED ø 15mm thickness 0.5mm brass Qty 1 pcs |                 |       |

|   |   |                 |       |
|---|---|-----------------|-------|
|  |   |                 |       |
| 1   |   |                 |       |
| <b>Part No.</b>   | 525387  | <b>Ref. No.</b> | 11079 |
| <b>description</b>  | plain washer ID ø 8mm ED ø 14mm thickness 0.5mm brass Qty 1 pcs |                 |       |

**GASTRO**PARTS.COM

