



GASTROPARTS

Hobart

- [EN]** Equipment
- [DE]** Geräte
- [ES]** Aparatos
- [FR]** Équipement
- [IT]** Attrezzature
- [PL]** Urządzenia
- [RU]** Оборудование

✉ gastroparts@gastroparts.com

☎ +48 56 657 00 66

📘 fb.com/gastroparts.global

GASTROPARTS.COM







heating elements



dry heating elements for dishwashers

 <p>1</p>			
Part No.	420180	Ref. No.	229189-26
description	heating element 1220W 254V heating circuits 1 L 425mm W 65mm tube ø 8.4mm connection M4 dry heating element flange connection flange length 81mm flange width 28mm hole ø 6.6mm		

 <p>1</p>			
Part No.	420179	Ref. No.	229189-22
description	heating element 1830W 254V heating circuits 1 L 425mm W 65mm tube ø 8.4mm connection M4 dry heating element flange connection flange length 81mm flange width 28mm hole ø 6.6mm		
For models:	CR-F		



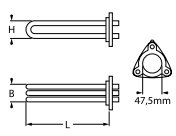



 <p>1</p>			
Part No.	420178	Ref. No.	229189-23
description	heating element 2440W 254V heating circuits 1 L 425mm W 65mm tube ø 8.4mm connection M4 dry heating element flange connection flange length 81mm flange width 28mm hole ø 6.6mm		
For models:	FTX		

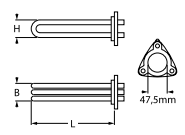

accessories for	415001		
	Part No.	560131	Ref. No. —
	hexagonal nut thread M4 H 3.2mm WS 7 SS DIN/ISO DIN 934 / ISO 4032/8673 Qty 20 pcs		

 <p>1</p> 			
Part No.	420302	Ref. No.	01-240761-001 01-240761-002 01-240761-1 240761-2
description	heating element 6000W 240V mounting ø 47.5mm heating circuits 3 L 325mm W 33mm H 37mm number of thermostat sleeves 1 thermostat sleeves ø 5mm length thermostat sleeves 140mm thermostat sleeve centre not clinging tube ø 8.3mm hole distance 62mm hole ø 10mm connection male faston 6.3mm 3 hole flange immersion heater		
For models:	AM-10, AM-11, AM-141, ECOMAX-402, ECOMAX-502, ECOMAX-602-10		
accessories for	420302		
	Part No.	521030	Ref. No. 01-240135-011 01-240135-11 1-240135-11 240135-11
	O-ring Viton thickness 5.34mm ID ø 47mm Qty 1 pcs		



immersion heating elements

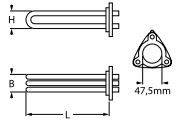



3 hole flange ø47.5mm

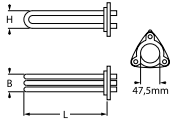

 <p>1</p> 			
Part No.	415001	Ref. No.	37145012
description	heating element 4500W 230V mounting ø 47.5mm heating circuits 3 L 316mm W 35mm H 34mm number of thermostat sleeves 1 thermostat sleeves ø 7mm length thermostat sleeves 180mm thermostat sleeve eccentric, non clinging tube ø 6.3mm hole distance 62mm hole ø 8mm connection M4 3 hole flange immersion heater		
For models:	GF-60, GF-60S		
spare parts for	415001		
	Part No.	510408	Ref. No. —
	O-ring EPDM thickness 5.34mm ID ø 47mm Qty 1 pcs		
accessories for	415001		
	Part No.	510562	Ref. No. —
	O-ring silicone thickness 5.34mm ID ø 47mm Qty 1 pcs		
	Part No.	521103	Ref. No. —
	nut thread M4 H 3mm WS 7 brass Qty 20 pcs		
	Part No.	521104	Ref. No. —
	washer ID ø 4.3mm ED ø 8mm thickness 0.5mm brass Qty 20 pcs for thread M4		
	Part No.	560111	Ref. No. —
	plain washer ID ø 4.3mm ED ø 9mm thickness 0.8mm SS Qty 20 pcs DIN 125A for thread M4		

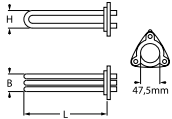
 <p>1</p> 			
Part No.	416240	Ref. No.	139321-1031
description	heating element 6545W 230/400V mounting ø 48mm heating circuits 3 L 355mm W 31mm H 37mm number of thermostat sleeves 1 thermostat sleeves ø 7mm length thermostat sleeves 175mm thermostat sleeve upper centre not clinging tube ø 6.5mm hole distance 63mm hole ø 10mm connection M4 3 hole flange immersion heater		
accessories for	416240		
	Part No.	510408	Ref. No. —
	O-ring EPDM thickness 5.34mm ID ø 47mm Qty 1 pcs		
	Part No.	510562	Ref. No. —
	O-ring silicone thickness 5.34mm ID ø 47mm Qty 1 pcs		

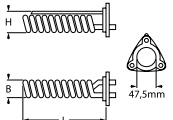

 			
Part No.	419005	Ref. No.	01-240135-002 01-240135-2 02-240135-001
description	heating element 7260W 250V mounting \varnothing 47.5mm heating circuits 3 L 375mm W 31mm H 35mm number of thermostat sleeves 1 thermostat sleeves \varnothing 5mm length thermostat sleeves 220mm thermostat sleeve centre not clinging tube \varnothing 8.5mm connection male faston 6.3mm 3 hole flange immersion heater		
For models:	AM900-10N, AM900-90, AMS900-10N, AMX, AMX-10HL, AMX-90, AMXR, AMXS, AMXT, AMXTS, AMXX, AMXXR, AMXXS, AUP, AUP-90, AUPS, AUXX, AUXXL-11N, AUXXLS-11N, AUXXR, AUXXS, AUXXT, AUXXTS, ECOMAX-602-11, ECOMAX-602S-11, ECOMAX-612-10, ECOMAX-612S-10, FP, FX, FX-McDonalds, GP, GX		
accessories for	419005		
	Part No.	510408	Ref. No. —
	O-ring EPDM thickness 5.34mm ID \varnothing 47mm Qty 1 pcs		

 			
Part No.	416241	Ref. No.	139321-935
description	heating element 8000W 230V mounting \varnothing 47.5mm heating circuits 3 L 355mm W 35mm H 35mm number of thermostat sleeves 1 thermostat sleeves \varnothing 7.5mm length thermostat sleeves 185mm thermostat sleeve not clinging tube \varnothing 6.3mm hole distance 64mm hole \varnothing 8mm connection M4 3 hole flange immersion heater		
spare parts for	416241		
	Part No.	510408	Ref. No. —
	O-ring EPDM thickness 5.34mm ID \varnothing 47mm Qty 1 pcs		
accessories for	416241		
	Part No.	510093	Ref. No. 139321-053
	protection cap		
	Part No.	510408	Ref. No. —
	O-ring EPDM thickness 5.34mm ID \varnothing 47mm Qty 1 pcs		
	Part No.	510562	Ref. No. —
	O-ring silicone thickness 5.34mm ID \varnothing 47mm Qty 1 pcs		

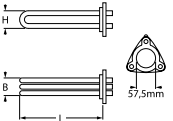

 			
Part No.	415668	Ref. No.	139221-246 139321-246 371450-13
description	heating element 2625W 230V mounting \varnothing 47.5mm heating circuits 1 L 190mm W 41mm H 54mm number of thermostat sleeves 1 thermostat sleeves \varnothing 7mm length thermostat sleeves 170mm thermostat sleeve eccentric, non clinging tube \varnothing 6.3mm hole distance 62mm hole \varnothing 8mm connection M4 3 hole flange immersion heater		
For models:	GE-400, GF-60, GF-60S, GW-600, GW-600S, GW-601, GW-601S		
accessories for	415668		
	Part No.	510562	Ref. No. —
	O-ring silicone thickness 5.34mm ID \varnothing 47mm Qty 1 pcs		

3 hole flange \varnothing 57.5mm

 			
Part No.	418140	Ref. No.	1235430
description	heating element 7500W 230V mounting \varnothing 57.5mm heating circuits 3 L 295mm W 34mm H 45mm number of thermostat sleeves 1 thermostat sleeves \varnothing 7mm length thermostat sleeves 275mm thermostat sleeve not clinging tube \varnothing 6.3mm hole distance 72mm hole \varnothing 8mm connection M4 3 hole flange immersion heater		



with compression flange 50 x 26mm

group 1



			
Part No.	420071	Ref. No.	01-240766-001 01-240766-1 01-240766-101
description	heating element 2000W 240V heating circuits 1 flange 50x26mm L 320mm W 36mm Hmm compression flange connection male faston 6.3mm tube \varnothing 8.6mm immersion heater		
For models:	ECOMAX-402, ECOMAX-502		
accessories for	420071		
	Part No.	510387	Ref. No. —
	gasket L 46mm W 22mm \varnothing mm EPDM for heating element for flange 50x26mm		







			
1			
Part No.	420462	Ref. No.	01-240247-001 01-240247-1 01-515292-001 01-515292-1 01-515292-101
description	service kit 975W 250V flange 26.5x50mm L 168mm W 32mm heating circuits 1 tube ø 8.5mm H 35mm incl. accessories		
For models:	FP, FX, FX-McDonalds, GP, GX		

			
1			
Part No.	416292	Ref. No.	324187-2
description	heating element 2700W 230V heating circuits 1 flange 50x26mm L 380mm W 105mm L1 60mm L2 45mm L3 275mm M5 connection male faston 6.3mm tube ø 8.5mm immersion heater		
For models:	FE-W, FX, GX		
accessories for	416292		
	Part No.	510387	Ref. No. —
	gasket L 46mm W 22mm ømm EPDM for heating element for flange 50x26mm		
	Part No.	510388	Ref. No. —
	counterflange ømm hole distancemm perforation ømm L 43mm W 21mm SS for heating element for flange 50x26mm		

			
1			
Part No.	417517	Ref. No.	00-883423-001 883423-1
description	heating element 3000W 254V heating circuits 1 flange 50x26mm L 420mm W 70mm L1 58mm L2 70mm L3 320mm compression flange connection male faston 6.3mm horizontal tube ø 8.5mm immersion heater		
For models:	AM-10, AM-11, AM-141, AM900-10N, AM900-90, AMS900-10N, AMX, AMX-10HL, AMX-90, AMXR, AMXS, AMXT, AMXTS, AMXX, AMXXR, AMXXS, AUP, AUP-90, AUPS, AUXX, AUXXL-11N, AUXXLS-11N, AUXXR, AUXXS, AUXXT, AUXXTS, ECOMAX-602-10, ECOMAX-602-11, ECOMAX-602S-11, ECOMAX-612-10, ECOMAX-612S-10		

			
1			
Part No.	416293	Ref. No.	00-231982-009 231982-9
description	heating element 610W 254V heating circuits 1 flange 50x26mm L 370mm W 120mm L1 40mm L2 70mm L3 260mm compression flange connection 6.5 tube ø 8.5mm immersion heater		
For models:	AMX, AMX-E, AMX-ER, AMX-R, AUX, AUX_, AUX-E, AUX-ER, AUX-R, FE, FX, GX, HE, HE600-HL, HE-P, HX, HX-30, HX-30E, HX-30ES, HX-30S, HX-40, HX-40E, HX-40ES, HX-40S, HX-60-EHL, HX-E, HX-ES, HX-S, UXD-30		
accessories for	416293		
	Part No.	510387	Ref. No. —
	gasket L 46mm W 22mm ømm EPDM for heating element for flange 50x26mm		
	Part No.	510388	Ref. No. —
	counterflange ømm hole distancemm perforation ømm L 43mm W 21mm SS for heating element for flange 50x26mm		

			
1			
Part No.	416294	Ref. No.	231982-10
description	heating element 610W 440V heating circuits 1 flange 50x26mm L 365mm W 120mm L1 35mm L2 60mm L3 270mm compression flange connection male faston 6.3mm tube ø 8.5mm immersion heater		
For models:	AMX, AMX-E, AMX-ER, AMX-R, AUX, AUX_, AUX-E, AUX-ER, AUX-R, FX, GX, HX, HX-30, HX-30E, HX-30ES, HX-30S, HX-40, HX-40E, HX-40ES, HX-40S, HX-E, HX-ES, HX-S		
accessories for	416294		
	Part No.	510387	Ref. No. —
	gasket L 46mm W 22mm ømm EPDM for heating element for flange 50x26mm		
	Part No.	510388	Ref. No. —
	counterflange ømm hole distancemm perforation ømm L 43mm W 21mm SS for heating element for flange 50x26mm		

			
1			
Part No.	420538	Ref. No.	E230102
description	heating element 1600W 230V heating circuits 1 flange 50x26mm L 305mm W 47mm H 25mm tube ø 8.5mm connection F6.3		



Part No.	416234	Ref. No.	139321-719
description	heating element 600W 230V heating circuits 1 flange 50x26mm L 160mm W 45mm H 27mm tube ø 8.8mm connection male faston 6.3mm connection length 40mm immersion heater compression flange		
For models:	CLG-25		
accessories for	416234		
	Part No.	510387	Ref. No. —
	gasket L 46mm W 22mm ømm EPDM for heating element for flange 50x26mm		
	Part No.	510388	Ref. No. —
	counterflange ømm hole distancemm perforation ømm L 43mm W 21mm SS for heating element for flange 50x26mm		

with expansion flange 40 x 16mm

Part No.	416283	Ref. No.	324646-1
description	heating element 1830W 254V flange 40x16mm L 385mm W 36mm connection male faston 6.3mm heating circuits 1 tube ø 8.5mm immersion heater expansion flange		
For models:	FE, FE-W, FX, GX, HE, HE600-HL, HE-P, HX-60-EHL		

Part No.	420353	Ref. No.	227953-1
description	heating element 2000W 220V flange 40x16mm L 335mm W 39mm connection male faston 6.3mm heating circuits 1 tube ø 8.4mm immersion heater compression flange mounting distance 24mm		
For models:	CM1E, FM-30, FM-30U, FM-400H, FM-400U, FM-500, FM-500H, UW-55, WM2E		

Part No.	416284	Ref. No.	324646-2
description	heating element 2440W 254V flange 40x16mm L 402mm W 34mm connection male faston 6.3mm heating circuits 1 tube ø 8.5mm immersion heater expansion flange		
For models:	FE, FE-W, FX, GX, HE, HE600-HL, HE-P, HX-60-EHL		

Part No.	416388	Ref. No.	324646-4 D324646-4
description	heating element 3000W 230V flange 40x16mm L 410mm W 33mm connection male faston 6.3mm heating circuits 1 tube ø 8.5mm immersion heater expansion flange		
For models:	FE, FE-W, FX, GX, HE, HE600-HL, HE-P, HX-60-EHL		
spare parts for	416388		
	Part No.	416464	Ref. No. —
	heating element 2000W 230V L 600mm W 572mm thread 1/4" mounting distance 563mm connection length 45mm tube ø 8.6mm cable length 643mm heating circuits 1 dry heating element 2 hole fixing		

Part No.	416285	Ref. No.	324646-3
description	heating element 3050W 254V flange 40x16mm L 400mm W 36mm connection male faston 6.3mm heating circuits 1 tube ø 8.5mm immersion heater expansion flange with temperature fuse		
For models:	FE, FE-W, FX, GX, HE, HE600-HL, HE-P, HX-60-EHL		



with expansion flange 70 x 18mm

Part No.	416287	Ref. No.	324644-2
description	heating element 2000W 230V heating circuits 1 flange 70x18mm L 388mm W 64mm connection male faston 6.3mm tube ø 8.5mm immersion heater expansion flange		
For models:	AM-700, CR-F, ECOMAX-600, ECW, UX, UX-30, UX-30B, UX-30E, UX-30EB, UX-30EH, UX-30ES, UX-30ESB, UX-30ESH, UX-30H, UX-30-McDonalds, UX-30S, UX-30SB, UX-30SH, UX-60, UX-60B, UX-60E, UX-60EB, UX-60EH, UX-60EHB, UX-60H, UX-60HB, UXL, UXLS, UXS		

Part No.	416239	Ref. No.	230100
description	heating element 2600W 230V heating circuits 1 flange 70x18mm L 270mm W 65mm connection male faston 6.3mm tube ø 8.5mm immersion heater expansion flange		
For models:	ECOMAX-400-12, ECOMAX-400S-12		





			
Part No.	416286	Ref. No.	324644-1
description	heating element 3000W 230V heating circuits 1 flange 70x18mm L 408mm W 65mm connection male faston 6.3mm tube ø 8.5mm immersion heater expansion flange connection length 18mm		
For models:	AMX, AMX-E, AMX-ER, AMX-R, AUX, AUX-E, AUX-ER, AUX-R, CR-F, ECOMAX-700, ECW, UX, UX-30, UX-30B, UX-30E, UX-30EB, UX-30EH, UX-30ES, UX-30ESB, UX-30ESH, UX-30H, UX-30-McDonalds, UX-30S, UX-30SB, UX-30SH, UX-60, UX-60B, UX-60E, UX-60EB, UX-60EH, UX-60EHB, UX-60H, UX-60HB, UXL, UXLs, UXS, UXT, UXTH, UXTHL, UXTHLS, UXTHS, UXTL, UXTLH, UXTLHS, UXTLS, UXTS		

			
Part No.	419162	Ref. No.	775464-002 775464-2
description	heating element 3000W 240V heating circuits 1 flange 70x18mm L 318mm W 65mm connection male faston 6.3mm tube ø 8.5mm immersion heater expansion flange connection length 24mm TD ø 10mm with temperature probe		
For models:	AM900, AMS900, FX, GC, GC11, GC12, GC31, GC32, GC41, GC42, GX		
spare parts for	419162		
	Part No.	Ref. No.	775494-1
	 temperature probe NTC 10kOhm cable probe -40 up to +110°C cable°C connection male faston 4.8mm thread probe ø10x30mm cable lengthm		

			
Part No.	416288	Ref. No.	00-324637-002 324637-... 324637-2
description	heating element 4000W 230V heating circuits 2 flange 70x18mm L 410mm W 63mm connection F2.8mm / F6.3mm tube ø 8.5mm immersion heater expansion flange connection length 30mm		
For models:	CR-F, UX-30, UX-30B, UX-30E, UX-30EB, UX-30ES, UX-30ESB, UX-30S, UX-30SB, UX-60, UX-60B, UX-60E, UX-60EB, UX-60EH, UX-60EHB, UX-60H, UX-60HB		





			
Part No.	416289	Ref. No.	00-324637-001 324637-... 324637-1
description	heating element 6000W 230V heating circuits 2 flange 70x18mm L 417mm W 65mm connection male faston 6.3mm tube ø 9mm immersion heater expansion flange connection length 35mm		
For models:	AMX, AMX-E, AMX-ER, AMX-R, AMXX-1300, AMXXT, AUX, AUX-E, AUXER, AUX-R, AUXX-1300, AUXXL, AUXXT, CR-F, ECW, UX-60, UX-60B, UX-60E, UX-60EB, UX-60EH, UX-60EHB, UX-60H, UX-60HB, UXT, UXTH, UXTHL, UXTHLS, UXTHS, UXTL, UXTLH, UXTLHS, UXTLS, UXTS		

			
Part No.	419139	Ref. No.	775464-1
description	heating element 6000W 240V heating circuits 2 flange 70x18mm L 315mm W 62mm connection male faston 6.3mm tube ø 8.5mm		
For models:	AM900, AMS900, FX, GC, GC11, GC12, GC31, GC32, GC41, GC42, GX		

			
Part No.	419026	Ref. No.	324637-... 324637-3
description	heating element 6100W 254V heating circuits 2 flange 70x18mm L 420mm W 63mm connection F6.3 tube ø 8.5mm immersion heater expansion flange connection length 30mm		
For models:	AM-700, AMX-900, AMXR-900, AMXS-900, AMXX-1300, AMXXR-1300, AMXXS-1300, AMXXT, AUXX-1300, AUXXL, AUXXR-1300, AUXXS-1300, AUXXT, CN, CNA, CNB, CNR, CR, CR-F, CSA, ECOMAX-600, ECOMAX-650, ECOMAX-800, ECW, FTN, FTX, UX-30, UX-30B, UX-30E, UX-30EB, UX-30ES, UX-30ESB, UX-30S, UX-30SB, UX-60, UX-60B, UX-60E, UX-60EB, UX-60EH, UX-60EHB, UX-60H, UX-60HB		

			
Part No.	416243	Ref. No.	139321-463
description	heating element 7600W 230V heating circuits 3 flange 70x18mm L 390mm W 60mm H 13mm connection male faston 6.3mm tube ø 6.3mm immersion heater expansion flange INCOLOY-800		
For models:	CHF45, EF-40		

with round flange ø47.5mm

			
Part No.	416295	Ref. No.	226807-1
description	heating element 3000W 230V heating circuits 3 mounting ø 47.5mm L 185mm W 79mm H 30mm L1 35mm L2 150mm W1 23mm W2 34mm round flange connection male faston 6.3mm immersion heater tube ø 6.5mm		
For models:	AM-12E, AM-12EC, AM-12EF, AM-12ER, AM-600, AM-600C, AM-600CR, AM-600R, UW-100, UW-105		
accessories for	416295		
	Part No.	Ref. No.	—
	 O-ring EPDM thickness 5.34mm ID ø 47mm Qty 1 pcs		
	Part No.	Ref. No.	—
	 O-ring silicone thickness 5.34mm ID ø 47mm Qty 1 pcs		
	Part No.	Ref. No.	—
	 tension strap H 10mm L 21mm W 10mm hole ø 6.5mm for heating element		





			
Part No.	416296	Ref. No.	170495-2
description	heating element 6000W 230V heating circuits 3 mounting ø 47.5mm L 230mm W 128mm H 32mm L1 30mm L2 200mm W1 46mm W2 34mm round flange connection male faston 6.3mm immersion heater tube ø 6.3mm		
For models:	AM-12E, AM-12EC, AM-12EF, AM-12ER, AM-600, AM-600C, AM-600CR, AM-600R, UW-105		
accessories for	416296		
	Part No.	Ref. No.	—
	 O-ring EPDM thickness 5.34mm ID ø 47mm Qty 1 pcs		



Table continues overleaf



accessories for	416296		
	Part No.	510562	Ref. No. —
	O-ring silicone thickness 5.34mm ID ø 47mm Qty 1 pcs		
	Part No.	550002	Ref. No. —
	tension strap H 10mm L 21mm W 10mm hole ø 6.5mm for heating element		





Part No.	416297	Ref. No.	173649-1 173649-2
description	heating element 7500W 230V heating circuits 3 mounting ø 47.5mm L 230mm W 123mm H 31mm L1 32mm L2 198mm W1 45mm W2 35mm round flange connection male faston 6.3mm immersion heater tube ø 6.5mm		
For models:	AM-600, AM-600C, AM-600CR, AM-600R, UW-105		

accessories for	416297		
	Part No.	510408	Ref. No. —
	O-ring EPDM thickness 5.34mm ID ø 47mm Qty 1 pcs		
	Part No.	510562	Ref. No. —
	O-ring silicone thickness 5.34mm ID ø 47mm Qty 1 pcs		
	Part No.	550002	Ref. No. —
	tension strap H 10mm L 21mm W 10mm hole ø 6.5mm for heating element		



Part No.	416298	Ref. No.	226506-1 226506-2
description	heating element 9000W 230V heating circuits 3 mounting ø 47.5mm L 230mm W 120mm H 34mm L1 25mm L2 205mm W1 42mm W2 36mm round flange connection male faston 6.3mm immersion heater tube ø 8.5mm connection length 44mm		
For models:	AM-12E, AM-12EC, AM-12EF, AM-12ER, AM-600, AM-600C, AM-600CR, AM-600R, UW-100, UW-105, UW-135, UW-135H		

accessories for	416298		
	Part No.	510408	Ref. No. —
	O-ring EPDM thickness 5.34mm ID ø 47mm Qty 1 pcs		
	Part No.	510562	Ref. No. —
	O-ring silicone thickness 5.34mm ID ø 47mm Qty 1 pcs		
	Part No.	550002	Ref. No. —
	tension strap H 10mm L 21mm W 10mm hole ø 6.5mm for heating element		

with round flange (miscellaneous)

Part No.	419183	Ref. No.	323949-1
description	heating element 7320W 254V L 355mm W 35mm H 35mm heating circuits 3 round flange connection F6.3 immersion heater tube ø 8.5mm		
For models:	EWB-S, UXT, UXTH, UXTHL, UXTHLS, UXTHS, UXTL, UXTLH, UXTLHS, UXTLS, UXTS		
accessories for	419183		
	Part No.	510409	Ref. No. 00-276903-053 00-67500-016 00-67500-118 276903-53 670500-118 67500-118 67500-16
	O-ring EPDM thickness 5.34mm ID ø 56.52mm Qty 1 pcs		



Part No.	419103	Ref. No.	00-229148-001 229148-1 229148-1 (230V) 229148-2
description	heating element 9000W 240V L 520mm W 47mm H 41mm heating circuits 3 flange ø 71mm mounting thread M10 connection M4 tube ø 8.5mm connection length 21mm		
For models:	CR-F, CX, ECW, FTX, FUX, UW-135, UW-135H, UWX		



accessories for	419103		
	Part No.	510409	Ref. No. 00-276903-053 00-67500-016 00-67500-118 276903-53 670500-118 67500-118 67500-16
	O-ring EPDM thickness 5.34mm ID ø 56.52mm Qty 1 pcs		

special flanges



Part No.	420351	Ref. No.	166151-1 166151-2 38658-1
description	heating element 10000W 220/380V heating circuits 3 L 360mm W 127mm flange length 90mm flange width 90mm connection 4 hole flange warewashing tube ø 8.5mm H 42mm		
For models:	UW-120, UW-200		











miscellaneous			
			
1			
Part No.	416299	Ref. No.	324206-3 324206-6
description	heating element 2200W 230V heating circuits 1 L 420mm W 45mm H 35mm number of thermostat sleeves 1 thermostat sleeves ø 5mm length thermostat sleeves 365mm tube ø 8.5mm hole distance 45mm hole ø 10mm connection length 25mm 4 hole flange immersion heater flange width 63mm flange length 63mm		
For models:	FX, GX, HX, HX-30, HX-30E, HX-30ES, HX-30S, HX-40, HX-40E, HX-40ES, HX-40S, HX-E, HX-ES, HX-S		
accessories for	416299		
			
Part No.	505180	Ref. No.	00-233982-001 00-276903-021 233982-1 276903-21
O-ring EPDM thickness 3.53mm ID ø 47.22mm Qty 1 pcs			

			
1			
Part No.	416300	Ref. No.	324206-4
description	heating element 4500W 230V heating circuits 3 L 413mm W 45mm H 45mm number of thermostat sleeves 1 thermostat sleeves ø 5mm length thermostat sleeves 377mm tube ø 8.5mm hole distance 45mm hole ø 10mm connection M4 4 hole flange immersion heater flange width 63.5mm flange length 63.5mm		
For models:	FX, GX, HX, HX-30, HX-30E, HX-30ES, HX-30S, HX-40, HX-40E, HX-40ES, HX-40S, HX-E, HX-ES, HX-S		

			
1			
Part No.	416290	Ref. No.	324206-5
description	heating element 7500W 230V heating circuits 3 mounting ø 47.5mm L 415mm W 44mm H 44mm number of thermostat sleeves 1 thermostat sleeves ø 5mm length thermostat sleeves 369mm tube ø 8.5mm hole distance 46mm hole ø 10mm connection M4 4 hole flange immersion heater flange width 63.5mm flange length 63.5mm		
For models:	FX, GX, HX, HX-30, HX-30E, HX-30ES, HX-30S, HX-40, HX-40E, HX-40ES, HX-40S, HX-E, HX-ES, HX-S		
accessories for	416290		
			
Part No.	505180	Ref. No.	00-233982-001 00-276903-021 233982-1 276903-21
O-ring EPDM thickness 3.53mm ID ø 47.22mm Qty 1 pcs			





			
1			
Part No.	416502	Ref. No.	322158 322158-04 322158-4 845370-01 845370-1
description	heating element 8000W 240V heating circuits 3 L 305mm W 40mm Hmm number of thermostat sleeves thermostat sleeves ømm length thermostat sleevesmm tube ø 6.3mm hole distance 44.9mm hole ø 10mm connection length 23mm connection male faston 6.3mm 4 hole flange immersion heater flange width 63.5mm flange length 63.5mm ø 40mm		
For models:	CO-0611E, CO-1011E, CO-2011E, CS-0611E, CS-0612E, CS-0612E-A, CS-1011E, CS-1012E, CS-1012E-A, CS-1022E, CS-1022E-A, CS-2011E, CS-2012E, CS-2012E-A, CS-2022E, CS-2022E-A, CSD-0611E, CSD-0612E, CSD-0612E-A, CSD-1011E, CSD-1012E, CSD-1012E-A, CSD-1022E, CSD-1022E-A, CSD-2011E, CSD-2012E, CSD-2012E-A, CSD-2022E, CSD-2022E-A		
accessories for	416502		
			
Part No.	505180	Ref. No.	00-233982-001 00-276903-021 233982-1 276903-21
O-ring EPDM thickness 3.53mm ID ø 47.22mm Qty 1 pcs			





			
1			
Part No.	420204	Ref. No.	173906-1 173906-6
description	heating element 9000W 230V heating circuits 3 L 295mm W 43mm H 39mm tube ø 8.5mm hole distance 45mm hole ø 10mm connection M4 flange connection immersion heater flange width 63.4mm flange length 63.4mm		
For models:	102-G, 103G, 104G, 202-G, 203G, 204G, 2226, 2227, 302-G, 303G, 304G, 304T		
accessories for	420204		
			
Part No.	511655	Ref. No.	174529-1
gasket fibre L 64mm W 64mm thickness 2.3mm hole ø 9mm hole distance 45mm 4 holes ID ø 46mm			







			
1			
Part No.	416291	Ref. No.	324206-7 324206-8
description	heating element 9000W 230V heating circuits 3 L 407mm W 42mm H 43mm number of thermostat sleeves 1 thermostat sleeves ø 5mm length thermostat sleeves 370mm thermostat sleeve eccentric, non clinging hole distance 45mm hole ø 10mm connection M4 4 hole flange immersion heater flange width 63.5mm flange length 63.5mm		
For models:	FX, GX, HX, HX-30, HX-30E, HX-30ES, HX-30S, HX-40, HX-40E, HX-40ES, HX-40S, HX-E, HX-ES, HX-S		
accessories for	416291		
			
Part No.	505180	Ref. No.	00-233982-001 00-276903-021 233982-1 276903-21
O-ring EPDM thickness 3.53mm ID ø 47.22mm Qty 1 pcs			



			
1			
Part No.	415010	Ref. No.	139321203 371450205
description	heating element 2000W 230V heating circuits 1 L 260mm W 125mm H 20mm L1 110mm L2 150mm W1 42mm W2 83mm thread M10x1 mounting distance 70mm tube ø 6.5mm connection M4 immersion heater 2 hole fixing		
For models:	GE-400, GW-600, GW-600S, GW-601, GW-601S		
spare parts for	415010		
	Part No.	510416	Ref. No. —
	flat gasket fibre ED ø 19mm ID ø 10.5mm thickness 1.5mm for thread M10 Qty 1 pcs		
accessories for	415010		
	Part No.	504306	Ref. No. —
	gasket fibre ED ø 16mm ID ø 10mm thickness 2mm Qty 1 pcs		
	Part No.	510893	Ref. No. —
	O-ring EPDM thickness 2.62mm ID ø 9.92mm Qty 1 pcs		
	Part No.	520231	Ref. No. —
	nut thread M10x1 H 6mm WS 14 zinc-coated steel Qty 1 pcs		
	Part No.	521103	Ref. No. —
	nut thread M4 H 3mm WS 7 brass Qty 20 pcs		
	Part No.	521104	Ref. No. —
	washer ID ø 4.3mm ED ø 8mm thickness 0.5mm brass Qty 20 pcs for thread M4		
	Part No.	521129	Ref. No. —
	nut thread M10 H 6mm SS WS 17 Qty 1 pcs DIN/ISO DIN 439		
	Part No.	560111	Ref. No. —
	plain washer ID ø 4.3mm ED ø 9mm thickness 0.8mm SS Qty 20 pcs DIN 125A for thread M4		
	Part No.	560131	Ref. No. —
	hexagonal nut thread M4 H 3.2mm WS 7 SS DIN/ISO DIN 934 / ISO 4032/8673 Qty 20 pcs		

			
1			
Part No.	415665	Ref. No.	E230086
description	heating element 2750/3250W 220/240V heating circuits 1 L 380mm W 110mm H 30mm thread M10x1 mounting distance 75mm tube ø 6.5mm connection M4 immersion heater 2 hole fixing		
spare parts for	415665		
	Part No.	510893	Ref. No. —
	O-ring EPDM thickness 2.62mm ID ø 9.92mm Qty 1 pcs		
accessories for	415665		
	Part No.	510416	Ref. No. —
	flat gasket fibre ED ø 19mm ID ø 10.5mm thickness 1.5mm for thread M10 Qty 1 pcs		
	Part No.	520231	Ref. No. —
	nut thread M10x1 H 6mm WS 14 zinc-coated steel Qty 1 pcs		

accessories for	415665		
	Part No.	521103	Ref. No. —
	nut thread M4 H 3mm WS 7 brass Qty 20 pcs		
	Part No.	521104	Ref. No. —
	washer ID ø 4.3mm ED ø 8mm thickness 0.5mm brass Qty 20 pcs for thread M4		
	Part No.	521129	Ref. No. —
	nut thread M10 H 6mm SS WS 17 Qty 1 pcs DIN/ISO DIN 439		
	Part No.	560111	Ref. No. —
	plain washer ID ø 4.3mm ED ø 9mm thickness 0.8mm SS Qty 20 pcs DIN 125A for thread M4		
	Part No.	560131	Ref. No. —
	hexagonal nut thread M4 H 3.2mm WS 7 SS DIN/ISO DIN 934 / ISO 4032/8673 Qty 20 pcs		



			
1			
Part No.	416235	Ref. No.	139321-922
description	heating element 3000W 230V heating circuits 1 L 320mm W 50mm H 40mm thread M10x1 mounting distance 44mm tube ø 6.3mm connection male faston 6.3mm 2 hole fixing L1 32mm L2 288mm		
spare parts for	416235		
	Part No.	510893	Ref. No. —
	O-ring EPDM thickness 2.62mm ID ø 9.92mm Qty 1 pcs		
accessories for	416235		
	Part No.	510416	Ref. No. —
	flat gasket fibre ED ø 19mm ID ø 10.5mm thickness 1.5mm for thread M10 Qty 1 pcs		
	Part No.	510893	Ref. No. —
	O-ring EPDM thickness 2.62mm ID ø 9.92mm Qty 1 pcs		
	Part No.	521129	Ref. No. —
	nut thread M10 H 6mm SS WS 17 Qty 1 pcs DIN/ISO DIN 439		
	Part No.	560192	Ref. No. —
	tooth lock washer ID ø 10.4mm ED ø 18mm SS DIN/ISO DIN 6798A Qty 1 pcs for thread M10		



heating elements for convection



1

Part No.	418916	Ref. No.	845265-02 845265-1
description	heating element 12000W 240V heating circuits 3 ID ø 390mm ED ø 410mm L 410mm H 100mm H1 25mm H2 75mm thread M12x1 6 hole fixing connection male faston 6.3mm tube ø 8.5mm convection heating element		
For models:	CSL-10E, CSM-1011IE, CSM-1011N, CSM-1021IE, CSM-1021N, CSM-2021IE, CSM-2021N		
accessories for	418916		
	Part No.	101566	Ref. No. —
	nut thread M12x1 H 10mm WS 19 SS Qty 1 pcs		
	Part No.	506046	Ref. No. —
	flat gasket FIBER ED ø 19.5mm ID ø 13mm thickness 2mm Qty 1 pcs		
	Part No.	528622	Ref. No. —
	spring ø 15.3mm L 25mm wire gauge ø 1.25mm for water filling		







1

Part No.	418927	Ref. No.	N/A
description	heating element 12000W 240V heating circuits 3 ID ø 440mm ED ø 458mm L 472mm H 80mm L1 15mm H1 8mm H2 72mm thread M12x1 6 hole fixing connection male faston 6.3mm tube ø 6.3mm convection oven convection heating element		





1

Part No.	418929	Ref. No.	845265-05
description	heating element 6000W 240V heating circuits 3 ID ø 395mm ED ø 415mm L 415mm H 100mm H1 15mm H2 85mm thread M12x1 6 hole fixing connection male faston 6.3mm tube ø 8.5mm convection oven convection heating element		
For models:	CSM-2011IE, CSM-2011N		
accessories for	418929		
	Part No.	101566	Ref. No. —
	nut thread M12x1 H 10mm WS 19 SS Qty 1 pcs		
	Part No.	506046	Ref. No. —
	flat gasket FIBER ED ø 19.5mm ID ø 13mm thickness 2mm Qty 1 pcs		
	Part No.	528662	Ref. No. —
	flat gasket copper ED ø 16mm ID ø 12mm thickness 1.5mm		









1

Part No.	418930	Ref. No.	845265-04
description	heating element 6000W 240V heating circuits 3 ID ø 430mm ED ø 450mm L 470mm H 115mm H1 43mm H2 72mm thread M12x1 6 hole fixing connection male faston 6.3mm tube ø 8.5mm convection oven convection heating element		
For models:	CSM-2011IE, CSM-2011N		
accessories for	418930		
	Part No.	101566	Ref. No. —
	nut thread M12x1 H 10mm WS 19 SS Qty 1 pcs		
	Part No.	506046	Ref. No. —
	flat gasket FIBER ED ø 19.5mm ID ø 13mm thickness 2mm Qty 1 pcs		
	Part No.	528662	Ref. No. —
	flat gasket copper ED ø 16mm ID ø 12mm thickness 1.5mm		

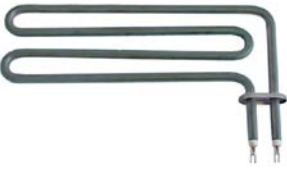

			
1			
Part No.	418926	Ref. No.	845265-03
description	heating element 8000W 240V heating circuits 3 ID ø 301mm ED ø 317mm L 328mm H 95mm L1 11mm H1 12mm H2 83mm thread M12x1 6 hole fixing connection male faston 6.3mm tube ø 8.5mm convection oven convection heating element		
For models:	CSL-06E, CSM-0611IE, CSM-0611N		

			
1			
Part No.	418928	Ref. No.	845265-01
description	heating element 9000W 240V heating circuits 3 ID ø 458mm ED ø 475mm L 475mm H 114mm H1 31mm H2 73mm thread M12x1 6 hole fixing connection male faston 6.3mm tube ø 8.5mm convection oven convection heating element		
For models:	CSL-10E, CSM-1011IE, CSM-1011N, CSM-1021IE, CSM-1021N, CSM-2021IE, CSM-2021N		
accessories for	418928		
	Part No.	101566	Ref. No. —
	nut thread M12x1 H 10mm WS 19 SS Qty 1 pcs		
	Part No.	506046	Ref. No. —
	flat gasket FIBER ED ø 19.5mm ID ø 13mm thickness 2mm Qty 1 pcs		
	Part No.	528662	Ref. No. —
	flat gasket copper ED ø 16mm ID ø 12mm thickness 1.5mm		

			
1			
Part No.	418925	Ref. No.	233848-2
description	heating element 1500W 230V heating circuits 1 L 293mm W 106mm L1 32mm L2 261mm W2 83mm flange length 50mm flange width 26mm connection length 63mm connection male faston 6.3mm tube ø 8.5mm hole ø 6.2mm W1 23mm convection heating element convection oven INCOLOY windings 2		
For models:	CO-0611E, CO-1011E, CO-2011E, CS-0611E, CS-1011E, CS-2011E, CSD-0611E, CSD-1011E, CSD-2011E		
accessories for	418925		
	Part No.	520588	Ref. No. —
	gasket L 46mm W 22mm hole distance 24.5mm silicone for heating element		

foil heating elements

			
1			
Part No.	420355	Ref. No.	775763-1
description	foil heating element L 288mm W 87mm 305W 240V t.max.°C silicone cable length 800mm thickness 1mm connection Faston 6.3mm		
For models:	GC, GC11, GC12, GC31, GC32		

			
1			
Part No.	420299	Ref. No.	898 126-1
description	foil heating element L 360mm W 95mm 545W 230V t.max.°C silicone cable length 1750mm thickness 1mm		
For models:	AM-700, AM900, AMS900, AMX-900, AMXR-900, AMXS-900, AMXX-1300, AMXXR-1300, AMXXS-1300, AMXXT, AUXX-1300, AUXXL, AUXXR-1300, AUXXS-1300, AUXXT, ECOMAX-650		

			
1			
Part No.	420475	Ref. No.	775575-1
description	foil heating element L 370mm W 95mm 390W 230V t.max.°C cable length 790mm		
For models:	FX, GX		

energy regulators

EGO

1-circuit



			
1			
Part No.	380015	Ref. No.	301200
description	energy regulator 230V 13A single-circuit turn direction right shaft ø 6x4.6mm shaft L 23mm mounting thread M4 power release 6-100% no. 50.57021.010		





thermostats

bi-metal thermostats

safety bi-metal thermostats

 <p>1</p>			
Part No.	390233	Ref. No.	139321-17 139321-923 139321-934 371450-17
description	bi-metal safety thermostat hole distance 24mm switch-off temp. 110°C 1NC 1-pole 16A connection F6.3 2 hole fixing without holder		
For models:	CHF45, CHH-50, CHH-60D, CHH-70D, CLG-25, EF-40, EH-60, EH-70, GE-400, GF-60, GF-60S		
accessories for	390233		
	Part No.	504736	Ref. No. —
	bracket for contact thermostat		
	Part No.	550388	Ref. No. —
	bracket for contact thermostat mounting distance 24.5mm mounting ø 3.8		

 <p>1</p>			
Part No.	390462	Ref. No.	226504
description	bi-metal safety thermostat hole distance mm switch-off temp. 105°C 1NC 1-pole 10A connection F6.3 1 hole fixing		
For models:	AM-12E, AM-12EC, AM-12EF, AM-12ER, AM-600, AM-600C, AM-600CR, AM-600R, CM1E, FM-30, FM-30U, FM-400H, FM-400U, FM-500, FM-500H, UW-100, UW-105, UW-135, UW-135H, UW-55, WM2E		
accessories for	390462		
	Part No.	550388	Ref. No. —
	bracket for contact thermostat mounting distance 24.5mm mounting ø 3.8		

 <p>1</p>			
Part No.	390318	Ref. No.	139321-721
description	bi-metal safety thermostat switch-off temp. 95°C 1-pole 2 hole fixing		
For models:	CLG-25		

bi-metal thermostats

 <p>1</p>			
Part No.	390504	Ref. No.	236052
description	bi-metal thermostat hole distance 23.8mm switch-off temp. 90°C 1NO 1-pole 16A 250V connection F6.3 2 hole fixing probe ø 16mm		

control and safety thermostats

EGO

control thermostats



51._ series

 <p>1</p>			
Part No.	390306	Ref. No.	139321532
description	thermostat t.max. 85°C temperature range fixed 85°C 1-pole gland nut		
For models:	CLG-25		

55.10/19_ series

 <p>1</p>			
Part No.	375184	Ref. No.	144451108
description	thermostat t.max. 298°C temperature range 55-294°C 1-pole 1NO 16A probe ø 3.1mm probe L 226mm capillary pipe 870mm capillary pipe isolated 350mm gland nut shaft L 23mm shaft position upper probe material SS		

55.13_ series

 <p>1</p>			
Part No.	375007	Ref. No.	139866-48
description	thermostat t.max. 110°C temperature range 30-110°C 1-pole 1NO 16A probe ø 6mm probe L 113mm capillary pipe 870mm capillary pipe isolated mm gland nut M9x1 shaft L 25mm shaft position upper rotation 270°		
accessories for	375007		
	Part No.	110119	Ref. No. —
	knob thermostat t.max. 110°C ø 50mm shaft ø 6x4.6mm shaft flat upper black temperature range 30-110°C rotation 270°		
	Part No.	110241	Ref. No. —
	knob thermostat t.max. 110°C ø 50mm shaft ø 6x4.6mm shaft flat upper black temperature range 30-110°C		



Part No.	390472	Ref. No.	886638
description	thermostat t.max. 95°C temperature range 27-95°C 1-pole 1NO 16A probe ø 4mm probe L 203mm capillary pipe 1230mm capillary pipe isolated 800mm gland nut shaft ømm shaft Lmm shaft position° shaft position rotation 270°		



Part No.	375355	Ref. No.	144605-71
description	thermostat t.max. 300°C temperature range 50-300°C 3-pole 3NO 16A probe ø 3mm probe L 219mm capillary pipe 900mm capillary pipe isolated 900mm gland nut shaft ø ø6x4.6mm shaft L 23mm shaft position upper rotation 270°		

55.34_ series



Part No.	375022	Ref. No.	T301062
description	thermostat t.max. 180°C temperature range 95-180°C 3-pole 3NO 16A probe ø 6mm probe L 133mm capillary pipe 1780mm capillary pipe isolated 1400mm gland nut M9x1 shaft ø ø6x4.6mm shaft L 23mm rotation 270°		

safety thermostats

55.13_ series



Part No.	390471	Ref. No.	227879
description	safety thermostat switch-off temp. 125°C 1-pole 16A probe ø 4mm probe L 128mm capillary pipe 1130mm capillary pipe isolated 800mm gland nut probe SS		
For models:	CR-F, CX, FX, GX, HX, HX-30, HX-30E, HX-30ES, HX-30S, HX-40, HX-40E, HX-40ES, HX-40S, HX-E, HX-ES, HX-S		



Part No.	375417	Ref. No.	49360008
description	thermostat t.max. 200°C temperature range 65-200°C 3-pole 3NO 16A probe ø 6mm probe L 79mm capillary pipe 840mm capillary pipe isolatedmm gland nut M9x1 shaft ø ø6x4.6mm shaft L 23mm rotation 270°		

55.31_ series



Part No.	375803	Ref. No.	4936005
description	safety thermostat switch-off temp. 225°C 3-pole 3NC 20A probe ø 6mm probe L 269mm capillary pipe 830mm capillary pipe isolatedmm gland nut probe		



55.32_ series



Part No.	375984	Ref. No.	301061
description	safety thermostat switch-off temp. 225°C 3-pole 3NC 20A probe ø 6mm probe L 94mm capillary pipe 900mm capillary pipe isolated 670mm gland nut M10x1 probe SS		

55.33_ series



Part No.	390470	Ref. No.	378791
description	safety thermostat switch-off temp. 100°C 3-pole 20A probe ø 4mm probe L 231mm capillary pipe 870mm capillary pipe isolated 800mm gland nut probe SS		
For models:	CDC, CN, CNA, CNB, CNR, CR, CSA, CTC, ECOMAX-700, ECW, FX, GX, UX, UX-30, UX-30B, UX-30E, UX-30EB, UX-30EH, UX-30ES, UX-30ESB, UX-30ESH, UX-30H, UX-30-McDonalds, UX-30S, UX-30SB, UX-30SH, UXL, UXLS, UXS		

56._ series



Part No.	375442	Ref. No.	301066
description	safety thermostat capillary pipe 1760mm probe ø 4mm 1-pole probe L 100mm 16A capillary pipe isolated 1600mm gland nut switch-off temp. 320°C probe		

control thermostats with operation switch

55.34_ series

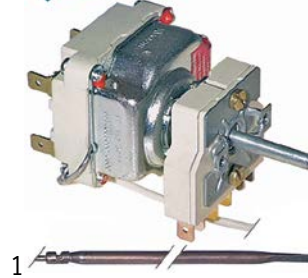

Part No.	375246	Ref. No.	301034
description	thermostat t.max. 645°C temperature range 100-615/645°C 2-pole 2NO 16A probe ø 4mm probe L 230mm capillary pipe 1100mm capillary pipe isolated 600mm gland nut shaft ø 6x4.6mm shaft L 25mm shaft position lower rotation 270° outer switch 2NO probe material copper		

IMIT / TEMPOMATIC / ARTHERMO

control thermostats

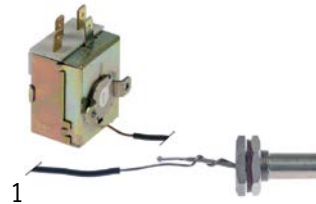

Part No.	390913	Ref. No.	371450-206 E236042 (old version)
description	thermostat t.max. 55°C temperature range fixed 55°C 1-pole 1CO 16A probe ø 11mm probe L 22mm capillary pipe 600mm capillary pipe isolated 600mm probe thread M14x1 250V contacts male faston 6.3mm		





Part No.	375847	Ref. No.	E929044
description	thermostat t.max. 90°C temperature range 0-90°C 1-pole 1CO 15A probe ø 6.5mm probe L 100mm capillary pipe 1500mm capillary pipe isolatedmm gland nut shaft ø 6x4.6mm shaft L 18mm shaft position +135° rotation 270° 250V		



CAEM

control thermostats



Part No.	390672	Ref. No.	139321-20 E236042
description	thermostat t.max. 53°C temperature range fixed 53°C 1-pole 1CO 16A probe ø 9.5mm probe L 30mm capillary pipe 600mm capillary pipe isolated 540mm gland nut shaft Lmm screw-in probe probe thread M14x1		
For models:	GW-600, GW-600S, GW-601, GW-601S		
spare parts for	390672		
	Part No.	510417	Ref. No. —
	flat gasket fibre ED ø 20mm ID ø 14mm thickness 2mm Qty 1 pcs		
	Part No.	550261	Ref. No. —
	nut thread M14x1 H 4mm WS 19 SS Qty 1 pcs		



Part No.	390686	Ref. No.	236043 E236043
description	thermostat t.max. 83°C temperature range°C 1-pole 1CO 20A probe ø 6mm probe L 90mm capillary pipe 630mm capillary pipe isolated 550mm gland nut shaft ømm shaft Lmm shaft position rotation 270° probe material copper		
For models:	CLG-25, CLG-25-NA, ECOMAX-500		

COTHERM

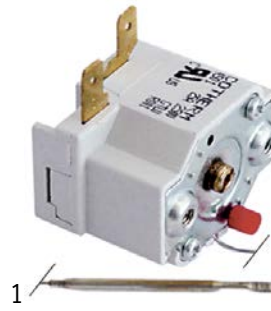

Part No.	390440	Ref. No.	154344 492105
description	safety thermostat t.max. 220°C temperature range°C 1-pole 1NC 25A probe ø 3mm probe L 130mm capillary pipe 1720mm capillary pipe isolatedmm gland nut switch-off temp. 220°C probe SS		
For models:	CS-0612E-A, CSD-0612E-A, CSD-0612ET, CSD-0612-UC, CSD-1012ET, CSD-1012-UC, CSD-1013G, CSD-1022-UC, CSD-2012ET, CSD-2012-UC, CSD-2013G, CSD-2022-UC, CSL-0423E, CSL-0423EK, CSL-0523E, CSL-0523EK, CSL-06E, CSL-10E, CSL-423E, CSL-423K, CSM-0611E, CSM-0611N, CSM-1011E, CSM-1011N, CSM-1021E, CSM-1021N, CSM-2011E, CSM-2011N, CSM-2021E, CSM-2021N		

RATHGEBER

control thermostats

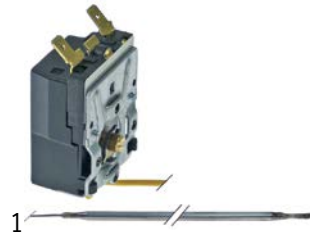

Part No.	390816	Ref. No.	226505
description	thermostat t.max. 95°C 1NO 16A probe ø 4mm probe L 244mm capillary pipe 1180mm capillary pipe isolated 840mm shaft ø 6mm shaft L 3mm rotation 315°		
For models:	AM-12E, AM-12EC, AM-12EF, AM-12ER, AMX, AMX-E, AMX-ER, AMX-R, AUX, AUX_, AUX-E, AUX-ER, AUX-R, CM1E, CNA, CNR, CSA, ECOMAX-600, ECOMAX-700, ECOMAX-800, FE, FX, GX, HE, HE600-HL, HE-P, HX, HX-30, HX-30S, HX-40, HX-40S, HX-S, UW-100, UX-30, UX-30B, UX-30E, UX-30EB, UX-30ES, UX-30ESB, UX-30S, UX-30SB, UX-60, UX-60B, UX-60E, UX-60EB, UX-60EH, UX-60EHB, UX-60H, UX-60HB, UXD-30... (Other models you can see in the webshop)		

accessories

plunger sockets



Part No.	550995	Ref. No.	139321-893
description	thermowell thread M14x1 ID ø 5mm L 40mm SS ø 9mm		



connecting bows



1

Part No.	550060	Ref. No.	300177
description	connecting bow long for thermostat Qty 1 pcs		

switches and momentary switches

rocker/momentary rocker switches

30x22mm



1

Part No.	301003	Ref. No.	15243565 F15243565
description	rocker switch mounting measurements 30x22mm green 2NO 250V 16A illuminated 0-I connection male faston 6.3mm ambient temperature max. 125/55°C protection IP65		
accessories for	301003		



Part No.	301036	Ref. No.	—
description	protective cover internal size 30x22mm for rocker switch mounting measurementsmm		

37x21mm



1

Part No.	348098 ¹	Ref. No.	00-358628-1
description	rocker switch mounting measurements 37x21mm black 2CO 250V 10A with neutral position connection male faston 6.3mm ambient temperature max. 125/55°C protection IP55		

¹with neutral position

push/momentary push switches

ø12mm



1

Part No.	347745	Ref. No.	302556
description	momentary switch with plunger thread M12x0.75 thread L 10mm 250V 2A 1NO connection male faston 6.3mm stroke 4mm ambient temperature max. 125°C type 1233A actuating force: 500g		

toggle switches

M12x0.75



1

Part No.	348193	Ref. No.	00-087711-143-1 00-120388 875567
description	toggle switch thread M12x0.75 2NO 250V 15A ON-OFF F6.3		
For models:	6614-MEAT-SAW		

microswitches

lever actuated



1

Part No.	345257	Ref. No.	139321-41
description	microswitch with lever 250V 16A 1CO connection male faston 6.3mm L 29mm L1 33mm ambient temperature max. 120°C mounting distance 22mm actuating force: 130g lever length 31.5mm		
For models:	GW-600, GW-600S, GW-601, GW-601S		

position switches

BERNSTEIN



1

Part No.	345922	Ref. No.	324195 735221-1
description	microswitch with knee switch 1NO/1NC 240V 3A L 51mm W 26mm H 21mm protection IP30 actuating force: 580g screw connection mounting distance 15mm AC-15 3A		
For models:	FE, FE-W, FX, GX		



1

Part No.	347237	Ref. No.	302440-1
description	position switch with handle with a switch 1NO/1NC		
For models:	UW-135, UW-135H		



1

Part No.	345921	Ref. No.	228795
description	position switch with roller 1CO 240V 3A L 93mm W 36mm H 33mm protection IP65 actuating force: 1280g screw connection M20 mounting distance 25mm		
For models:	ACW, AM-12E, AM-12EC, AM-12EF, AM-12ER, AM-600C, AM-600CR, FM-30, UWX		



1

Part No.	347721	Ref. No.	00-226916-000
description	position switch with roller plunger 1NO/1NC 240V 3A L 93mm W 36mm H 34mm protection IP65 actuating force: 1200g screw connection M18 mounting distance 24.5mm		
For models:	AM-600, AM-600C, AM-600CR, AM-600R, FTX, FUX, RRB, UW-100, UW-105		

TELEMECANIQUE (EFA)



1

Part No.	347460	Ref. No.	785286-1
description	position switch with roller 1NO/1NC L 71mm protection IP67		
For models:	CN, CNA, CNB, CNR, CR, CSA, ECOMAX-800		

system switches (ROLD)



1

Part No.	346498	Ref. No.	900055
description	element holder mounting measurements 28.5x28.5mm black single element holder		



1

Part No.	346500	Ref. No.	E226080
description	element holder mounting measurements 28.5x77.5mm black threefold element holder		



1

Part No.	345606	Ref. No.	139321-455 E226071
description	momentary switch unit 2CO 250V 16A connection male faston 6.3mm		
For models:	CLG-25		



1

Part No.	347517	Ref. No.	E207060 E227060
description	push button ø 21mm silver edition		



1

Part No.	347705	Ref. No.	227061
description	push button ø 21mm silver with lens edition		
For models:	CLG-25, CLG-25-NA, ECOMAX-400-12, ECOMAX-400S-12, ECOMAX-500		



1

Part No.	345605	Ref. No.	E208010
description	switch 2CO 250V 16A connection male faston 6.3mm		

float switches

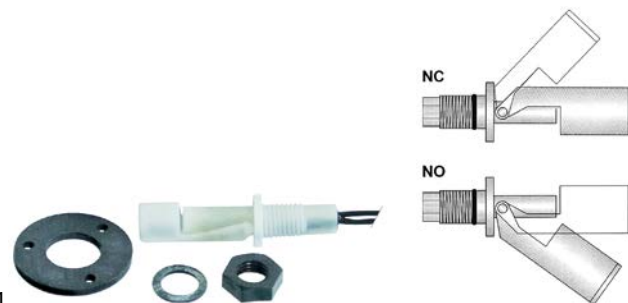

1

Part No.	541323	Ref. No.	774033-1 ML102831
description	float switch		
For models:	FE, FTN, FX, GX, HE		



1

Part No.	347491	Ref. No.	00-735171-001 735171-1
description	float switch thread M16x2 ø 18mm L 65mm cable length 1050mm 1-pole		

1

Part No.	348128	Ref. No.	00-896960-000
description	float switch thread M16x2 ø 18mm L 65mm cable length 1050mm kit 1-pole temp.-resist. -20 up to +90°C		

1

Part No.	403081	Ref. No.	102826 229519 ML102826
description	float switch thread 1/4" 1NC/1NO ø 12mm L 65mm mounting ø 16mm 24V 0.5A cable cable length 100mm		
For models:	ACW, CN, CNB, CNR, CX, EWB-S, FTN, FTX, FUX, UW-135H, UWX		
spare parts for	403081		
	Part No.	347433	Ref. No. 00-122674 122674
description	float with magnet ø 47mm L 33mm Wmm Hmm PVC suitable for HOBART		

1

Part No.	403914	Ref. No.	271621
description	float switch thread 1/4" ø 29mm L 100mm mounting ø 9.5mm coded cable length 240mm probe L 63mm		

floats

1

Part No.	347433	Ref. No.	00-122674
description	float with magnet ø 47mm L 33mm Wmm Hmm PVC suitable for HOBART		
For models:	103G, 203G, 2226, 303G, ACW, AM-12E, AM-12EC, AM-12EF, AM-12ER, AM15, AM15F, AM15T, AM-600, AM-600C, AM-600CR, AM-600R, C44A, C44AW, C54A, C64A, CN, CNA, CNB, CNR, CR, CR-F, CSA, CX, ECOMAX-800, EWB-S, FTN, FTT, FTX, FUX, ML-110025, ML-110976, ML-110977, ML-32614, ML-32615, UW-105, UW-135, UW-135H, UWX		
accessories for	347433		
	Part No.	347927	Ref. No. 00-112467 112467
description	bracket for magnetic switch ID ø 21mm ED ø 28.5mm		

cam switches

7-position

1

Part No.	300025	Ref. No.	MRTC700078
description	cam switch 7 operating positions 1NO/2CO sequence 0-1-2-3-4-5-6 16A shaft ø 6x4.6mm shaft L 23mm connection screw 7-position ceramic		
accessories for	300025		
	Part No.	112172	Ref. No. —
description	knob universal ø 70mm black without adaptor/dial plate		
	Part No.	112213	Ref. No. —
description	knob dial plate silver switch 7-position t.max.°C ED ø 63mm ID ø 45.5mm		
	Part No.	112311	Ref. No. —
description	knob adapter shaft ø 6x4.6mm L 0mm with spring		



4 operating positions



1			
Part No.	300077	Ref. No.	01-240135-003 1-240135-3 845259
description	cam switch 4 operating positions 5NO sequence 0-1-2-3 16A shaft \varnothing 6x4.6mm shaft L 23mm connection male faston 6.3mm plastic		
For models:	CSL-0423E, CSL-0423EK, CSL-0523E, CSL-0523EK, CSL-06E, CSL-10E, CSL-423E, CSL-423K, CSM-0611IE, CSM-0611N, CSM-1011IE, CSM-1011N, CSM-1021IE, CSM-1021N, CSM-2011IE, CSM-2011N, CSM-2021IE, CSM-2021N		

8 operating positions

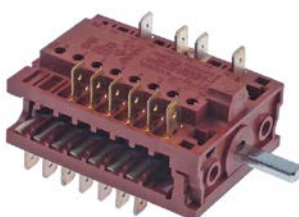

1			
Part No.	347924	Ref. No.	231960-5
description	cam switch 8 operating positions 13NO sequence 0-1-2-3-4-5-6-7 16A shaft \varnothing 6x4.6mm shaft L 19mm connection male faston 6.3mm plastic		
For models:	AMX, AMX-E, AMX-ER, AMX-R, AUX, AUX_, AUX-E, AUX-ER, AUX-R, FX, GX, UX-30, UX-30B, UX-30H, UX-30-McDonalds, UX-30S, UX-30SB, UX-30SH, UX-60, UX-60B, UX-60H, UX-60HB, UXD-30		

operation switches



1			
Part No.	300080	Ref. No.	491175
description	cam switch 2 operating positions 4NO 16A sequence 0-1 shaft \varnothing 6x4.6mm shaft L 23mm connection screw operation switch ceramic ambient temperature max. 150°C		
accessories for	300080		
	Part No.	551456	Ref. No. —
	gasket for switch ED \varnothing 14mm ID \varnothing 2.5mm thickness 3.5mm white		

rotary switches

BREMAS

A1200 series



1			
Part No.	300326	Ref. No.	E927034
description	rotary switch sets of contacts 6 0-1-2-3 type CS012015B 400V 12A shaft \varnothing 5x5mm shaft L 18mm		

KRAUS & NAIMER

rotary switches



1			
Part No.	347506 [†]	Ref. No.	785574-6
description	rotary switch 2 0-1 sets of contacts 5 type KG100-DE10F769 400V 100A shaft L 52mm L1,L2,L3,N,PE connection screw code 53/000100 marking T104/D-A025		

[†]incl. knob and dial plate

1			
Part No.	347240	Ref. No.	00-229580-000
description	rotary switch 8 0-1-2-3-4-5-6-7 sets of contacts 4 400V 20A connection screw		

VM





1			
Part No.	345917	Ref. No.	371450-172
description	rotary switch		
For models:	GF-60, GF-60S		



magnetic switches

1/4"



Part No.	347490	Ref. No.	226282 226282-2
description	magnetic switch thread 1/4" cable length 2000mm L 62.5mm		
For models:	103G, 203G, 2226, 303G, AM-12E, AM-12EC, AM-12EF, AM-12ER, AM-600, AM-600C, AM-600CR, AM-600R, CNA, CNR, CR, CR-F, CSA, ECOMAX-800, FTT, UW-100, UW-105, UW-135, UW-135H		
accessories for	347490		
	Part No.	347433	Ref. No. 00-122674 122674
	float with magnet ø 47mm L 33mm Wmm Hmm PVC suitable for HOBART		
	Part No.	347927	Ref. No. 00-112467 112467
	bracket for magnetic switch ID ø 21mm ED ø 28.5mm		
	Part No.	511516	Ref. No. —
	O-ring EPDM thickness 3.53mm ID ø 20.22mm Qty 10 pcs		

29x19mm

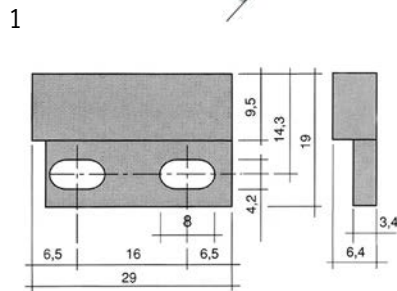

Part No.	345117	Ref. No.	844951-2
description	magnetic switch L 28.5mm W 19mm 1NO 250V 0.04A P max. 10W connection cable cable length 1000mm		

36x13mm

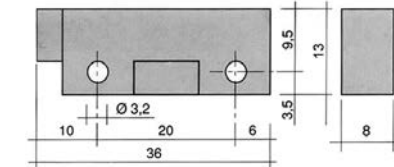
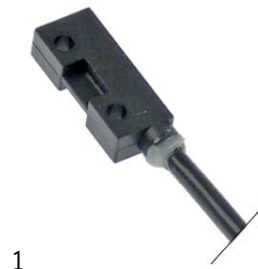

Part No.	345118 ¹	Ref. No.	139321-344 139321-586 139321-919
description	magnetic switch L 36mm W 13mm 1NO 250V 1A P max. 50W connection cable cable length 980mm		
For models:	CHF45, CHH-50, CHH-60D, CHH-70D, CLG-25, EF-40, EH-60, EH-70, GE-400, GF-60, GF-60S, GW-600, GW-600S, GW-601, GW-601S, UX, UXL, UXLS, UXS, UXT, UXTH, UXTHL, UXTHLS, UXTHS, UXTL, UXTLH, UXTLHS, UXTLS, UXTS		
accessories for	345118		
	Part No.	345399	Ref. No. —
	magnet ø 3.3mm L 40mm H 8mm W 13mm hole distance 30mm M3		

¹with coded connector

50x19mm

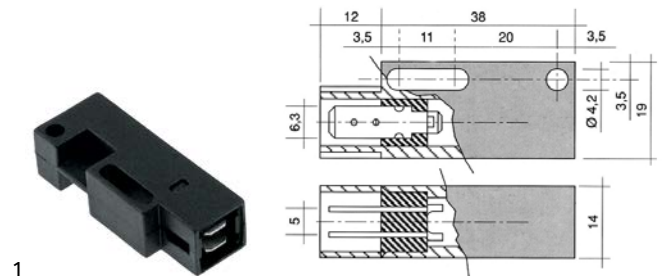

Part No.	345821	Ref. No.	775491-1
description	magnetic switch L 50mm W 19mm 1NO 250V 1A P max. 50W connection male faston 6.3mm		
For models:	AM-700, AM900, AMS900, AMX, AMX-900, AMX-E, AMX-ER, AMX-R, AMXR-900, AMXS-900, AMXX-1300, AMXXR-1300, AMXXS-1300, AMXXT, AUX, AUX-E, AUX-ER, AUX-R, AUXX-1300, AUXXL, AUXXR-1300, AUXXS-1300, AUXXT, CNA, CNR, ECOMAX-650, ECOMAX-700, FX, GX, UX-30, UX-30B, UX-30E, UX-30EB, UX-30EH, UX-30ES, UX-30ESB, UX-30ESH, UX-30H, UX-30-McDonalds, UX-30S, UX-30SB, UX-30SH, UXD-30		
accessories for	345821		
	Part No.	519049	Ref. No. —
	magnet ømm L 63mm H 10.7mm W 18.8mm hole distance 52mm M2 hole ø 2mm		



80x30mm



1

Part No.	347925	Ref. No.	229517
description	magnetic switch L 80mm W 30mm 1NO 250V 0.2A P max. 100W connection cable cable length 1300mm		
For models:	CN, CNB, CSA, ECOMAX-800, ECW, FTN, FTT, HX, HX-30, HX-30S, HX-40, HX-40S, HX-E, HX-ES, HX-S, UW-120, UW-200, UX-60EH, UX-60EHB, UX-60H, UX-60HB		



1

Part No.	345918	Ref. No.	229517-2
description	magnetic switch L 80mm W 30mm 1NO 250V 0.2A P max. 100W connection cable cable length 4500mm		
For models:	ECOMAX-600, ECOMAX-700, FTX, FUX, HE, HE600-HL, HE-P, HX-60-EH		



1

Part No.	345920	Ref. No.	297980-4
description	magnetic switch L 80mm W 30mm 1NO 250V 3A connection cable 100W		
For models:	AMX, AMX-E, AMX-ER, AMX-R, AUX, AUX_, AUX-E, AUX-ER, AUX-R, UX-30, UX-30B, UX-30E, UX-30EB, UX-30EH, UX-30ES, UX-30ESB, UX-30ESH, UX-30H, UX-30-McDonalds, UX-30S, UX-30SB, UX-30SH, UX-60, UX-60B, UX-60E, UX-60EB, UX-60EH, UX-60EHB, UX-60H, UX-60HB		

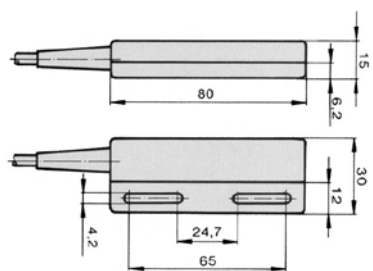

1

Part No.	345919	Ref. No.	297980-3
description	magnetic switch L 80mm W 30mm connection cable		
For models:	HX, HX-30E, HX-30ES, HX-40E, HX-40ES, HX-E, HX-ES, HX-S		

ø 6mm



1

Part No.	347835	Ref. No.	01-235338
description	magnetic switch 150V 1A P max. 10W probe L 29mm 1NO connection 2-wire cable length 1700mm		



1

Part No.	347461	Ref. No.	01-240288-001 01-240288-1
description	magnetic switch 28V 0.5A P max. 15W probe L 26mm 1NO connection coded plug cable length 280mm		
For models:	AM-10, AM-11, AM-141, AM900-10N, AM900-90, AMS900-10N, AMX, AMX-10HL, AMX-90, AMXR, AMXS, AMXT, AMXTS, AMXX, AMXXR, AMXXS, AUP, AUP-90, AUPS, AUXX, AUXXL-11N, AUXXS-11N, AUXXR, AUXXS, AUXXT, AUXXTS, CN-Protronic, CN-Smartronic, CP-Protronic, ECOMAX-402, ECOMAX-502, ECOMAX-602-10, ECOMAX-602-11, ECOMAX-602S-11, ECOMAX-612-10, ECOMAX-612S-10, FP, FX, FX-Mc-Donalds, GP, GX		

accessories for	347461	Part No.	524661	Ref. No.	00-883838-001 883838-1
	bracket for magnetic switch L 34.5mm W 26mm H 9mm				

ø 8mm



1

Part No.	348194	Ref. No.	87711-352
description	magnetic switch 200V 0.5A P max. 10W W 8mm probe L 30mm 1NO connection coded plug cable length 290mm M8		



accessories

magnets



1

Part No.	347926	Ref. No.	166964 170015
description	magnet ø 22.5mm Lmm H 11.5mm Wmm ID ø 5.2mm M5		
For models:	AM-700, AM900, AMS900, AMX, AMX-900, AMX-E, AMX-ER, AMX-R, AMXR-900, AMXS-900, AMXX-1300, AMXXR-1300, AMXXS-1300, AMXXT, AUX, AUX_, AUX-E, AUX-ER, AUX-R, AUXX-1300, AUXXL, AUXXR-1300, AUXXS-1300, AUXXT, CNR, CR-F, CX, ECOMAX-600, ECOMAX-650, ECOMAX-700, FTT, FTX, FUX, HE, HE600-HL, HE-P, HX, HX-30, HX-30E, HX-30ES, HX-30S, HX-40, HX-40E, HX-40ES, HX-40S, HX-60-EHL, HX-E, HX-ES, HX-S, UW-135...(Other models you can see in the webshop)		



1

Part No.	347722	Ref. No.	00-774714-001 774714-1
description	magnet ø 34mm Lmm H 17mm Wmm ID ø 5mm M5 with cap hole ø 5.25mm		
For models:	CN, CNA, CNB, CN-Protronic, CNR, CN-Smartronic, CP-Protronic, CR, CSA, CS-Easytronic, ECOMAX-800, ECW, FTN, FTX, FUX, UX-30B, UX-30EB, UX-30EH, UX-30ESB, UX-30ESH, UX-30H, UX-30-McDonalds, UX-30SB, UX-30SH, UX-60, UX-60B, UX-60E, UX-60EB, UX-60EH, UX-60EBH, UX-60H, UX-60HB, UXD-30, UXTH, UXTHL, UXTHLS, UXTHS, UXTLH, UXTLHS		



1

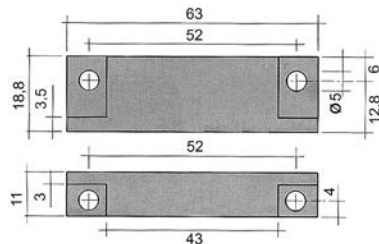

Part No.	345336	Ref. No.	E926014
description	magnet ø 4.8mm L 63mm H 11mm W 18.8mm hole distance 51mm M4		



1

Part No.	346953	Ref. No.	139321-820
description	magnet ømm L 23mm H 17mm W 18mm M6 hole ø 6.5mm		

miscellaneous



1

Part No.	347927	Ref. No.	00-112467
description	bracket for magnetic switch ID ø 21mm ED ø 28.5mm		
For models:	103G, 203G, 2226, 303G, AM-12E, AM-12EC, AM-12EF, AM-12ER, AM15, AM15F, AM15T, C44A, C44AW, C54A, C64A, CN, CNA, CNB, CNR, CR, CR-F, CSA, CX, ECOMAX-800, EWB-S, FTN, FTT, FTX, FUX, ML-110025, ML-110976, ML-110977, ML-32614, ML-32615, UW-100, UW-105, UWX		



1

Part No.	524661	Ref. No.	00-883838-001 883838-1
description	bracket for magnetic switch L 34.5mm W 26mm H 9mm		
For models:	AM-10, AM-11, AM-141, AM900-10N, AM900-90, AMS900-10N, AMX, AMX-10HL, AMX-90, AMXR, AMXS, AMXT, AMXTS, AMXX, AMXXR, AMXXS, AUP, AUP-90, AUPS, AUXX, AUXXL-11N, AUXXL-11N, AUXXR, AUXXS, AUXXT, AUXXTS, CN-Protronic, CN-Smartronic, CP-Protronic, ECOMAX-402, ECOMAX-502, ECOMAX-602-10, ECOMAX-602-11, ECOMAX-602S-11, ECOMAX-612-10, ECOMAX-612S-10		

control equipment

MOELLER/EATON

push buttons - signal lamps



1

Part No.	347512	Ref. No.	887015-33
description	push button mounting measurements ø22mm green illuminable momentary I		
For models:	RRB		



1

Part No.	346339	Ref. No.	887015-25
description	push button mounting measurements ø22mm red mushroom cap latching EMERGENCY SHUT-DOWN		

knobs



1

Part No.	346460	Ref. No.	887015-61
description	selector switch mounting measurements ø22mm black/white 0°-45° latching sequence 0-1		



1

Part No.	346728	Ref. No.	887015-71
description	selector switch mounting measurements ø22mm black/white 330°-0°-30° latching sequence 1-0-2		
For models:	ECOMAX-800		

switch blocks



1

Part No.	346293	Ref. No.	00-887015-012
description	contact block holder triple		

switches (complete)

push/momentary push switches



1

Part No.	344003	Ref. No.	229576-2 229577-1 301776-9 895405 EPM-E-16-14
description	momentary push switch mounting measurements ø22mm green 1NO on momentary		
For models:	HSM20, HSM30, HSM40, NCM20, NCM300, NCM400		

SCHLEGEL

switches (complete)



1

Part No.	347923	Ref. No.	324267-4 897900
description	momentary switch mounting measurements ø16/24x24mm white 1NO/1NC sequence 0-1 infinite		
For models:	ECOMAX-600, ECOMAX-700, FE, HE, HE600-HL, HE-P		
spare parts for	347923		



Part No.	359183	Ref. No.	—
description	momentary switch unit mounting measurements ø16/24x24mm type momentary anthracite/transparent square		



Part No.	359194	Ref. No.	324267-1 32427-1
description	contact block latching 1NC/1NO connection male faston 2.8mm illuminable socket T5.5K type AFL		



Part No.	359796	Ref. No.	324265-11
description	symbol plate white infinite		



1

Part No.	358178	Ref. No.	897902
description	momentary switch mounting measurements ø16/24x24mm white square 1NO/1NC sequence 0-1 clock connection male faston 2.8mm type AT		

push buttons



1

Part No.	359794	Ref. No.	324266-1
description	momentary switch unit mounting measurements ø16/24x24mm type momentary black/transparent square		
For models:	ECOMAX-600, ECOMAX-700, ECOMAX-800, FE, FX, GF-60, GF-60S, GX, HE, HE600-HL, HE-P		

symbol plates





1

Part No.	359795	Ref. No.	00-324265-001 324265-1
description	symbol plate white clock		
For models:	ECOMAX-600, ECOMAX-700, FX, GF-60, GF-60S, GX, HE, HE600-HL, HE-P		





			
1			
Part No.	359796	Ref. No.	324265-11
description	symbol plate white infinite		
For models:	ECOMAX-600, ECOMAX-700, HE, HE600-HL, HE-P		

			
1			
Part No.	359189	Ref. No.	324265-10
description	symbol plate white on		
For models:	ECOMAX-600, ECOMAX-700, HE, HE600-HL, HE-P		

			
1			
Part No.	359193	Ref. No.	324265-12
description	symbol plate white water		
For models:	ECOMAX-600, ECOMAX-700, HE, HE600-HL, HE-P		

switch blocks			
			
1			
Part No.	359194	Ref. No.	324267-1 32427-1
description	contact block latching 1NC/1NO connection male faston 2.8mm illuminable socket T5.5K type AFL		

			
1			
Part No.	359187	Ref. No.	324267-3 897903
description	contact block latching 2NO/2NC connection male faston 2.8mm illuminable socket T5.5K type AFL2		
For models:	ECOMAX-600, ECOMAX-700, HE600-HL		

			
1			
Part No.	359793	Ref. No.	324267-5 897901
description	contact block momentary 2NO/2NC connection male faston 2.8mm illuminable socket T5.5K type ATL2		
For models:	ECOMAX-600, ECOMAX-700, FE, HE600-HL		

lamps

indicator lights

indicator light lenses			
ø12mm (type SDY-3)			
			
1			
Part No.	359262	Ref. No.	E926114
description	indicator light housings mounting measurements ø12mm green round Qty 1 pcs		

indicator lamps for socket type SRZ / SDK / SDY / SFK			
			
1			
Part No.	359130	Ref. No.	216006 E216006
description	indicator lamp 230V clear connection male faston 6.3mm ø 8mm		

lamps			
light bulbs			
			
1			
Part No.	359608	Ref. No.	229167-1
description	light bulb socket E14 10/15W 230V ø 16mm L 51mm lens L 31mm Qty 1 pcs		
For models:	CX		

indicator lights (complete)			
ø12mm			
with plug-in socket			
			
1			
Part No.	580014	Ref. No.	347336-1 XNC25X68
description	indicator light ø 12mm 230V red		



screw-on/push-on fit

light bulbs

for indicator lights



1

Part No.	359608	Ref. No.	229167-1
description	light bulb socket E14 10/15W 230V ø 16mm L 51mm lens L 31mm Qty 1 pcs		
For models:	CX		

halogen lamp

for socket G4 / G6.35 / G9



1

Part No.	357193	Ref. No.	1235342
description	halogen lamp socket G4 12V 20W temp.-resist. 300°C OSRAM HALOSTAR OVEN		



1

Part No.	359599	Ref. No.	844952
description	halogen lamp socket G4 12V 20W temp.-resist. 500°C		

fluorescent lamps

fluorescent lamps

G23



1

Part No.	359933	Ref. No.	491761-001
description	fluorescent lamp socket G23 L 237mm 11W 230V		

oven lamps

lamps

halogen lamps

for socket G4 / G6.35 / G9



1

Part No.	357193	Ref. No.	1235342
description	halogen lamp socket G4 12V 20W temp.-resist. 300°C OSRAM HALOSTAR OVEN		



1

Part No.	359599	Ref. No.	844952
description	halogen lamp socket G4 12V 20W temp.-resist. 500°C		

timers

programme timers



1

Part No.	360349	Ref. No.	139321-226 E238053
description	timer CDC 11803 engines 1 chambers 3 operation time 150s 230V shaft ømm shaft Lmm manuf. no. 11803F1BEE000.0010 motor type M48R ATS type 11803F1 / 238046		
For models:	GW-600, GW-600S, GW-601, GW-601S		
spare parts for	360349		
	Part No.	360673	Ref. No. —
	motor kit pinion ø 6.8mm teeth 15 230V voltage AC 50/60Hz turn direction clockwise motor ø 48mm H 18.5mm motor type UDS-40NE1RNZ165 cable length 150mm with holder		

electric timers



1

Part No.	350201	Ref. No.	00-294650-004-1 294650-4-1
description	timer M006 with bell operation time 15min time spreadmin 1NO permanent position yes impulse electric shaft ø 6x4.6mm shaft L 22mm mounting distance 28mm mounting thread M4 connection male faston 4.8mm 115V voltage AC 60Hz 1-pole		
For models:	A120, H600, H600C, H600D, L800, L800C, L800D, M802, ML-104483, ML-104484, ML-104674, ML-104683, ML-104686, ML-104687, ML-104694, ML-104696, ML-134118, ML-134185, ML-134188, V1401		



mechanical timers

 <p>1</p>			
Part No.	350168	Ref. No.	845384 895401-189
description	timer C53 2-pole operation time 120min impulse mechanical 1NO/1NC at 250V 16A permanent position no shaft 6x4.6mm shaft L 23mm mounting distance 28mm connection lateral		
For models:	CSL-0423E, CSL-0423EK, CSL-0523E, CSL-0523EK, CSL-06E, CSL-10E, CSL-423E, CSL-423K, CSM-0611E, CSM-0611N, CSM-1011E, CSM-1011N, CSM-1021E, CSM-1021N, CSM-2011E, CSM-2011N, CSM-2021E, CSM-2021N		

alarm devices

buzzers

 <p>1</p>			
Part No.	350050	Ref. No.	173864
description	buzzer 230VAC connection male faston 6.3mm screw mounting thread M4 60dB		
For models:	CO-0611E, CO-0612E, CO-1011E, CO-1012E, CO-2011E, CS-0423E, CS-0423EK, CS-0523E, CS-0523EK, CS-0611E, CS-0612E, CS-1011E, CS-1012E, CS-2011E, CS-2012E, CS-2022E, CS-423E, CS-423K, CSD-0611E, CSD-0612E, CSD-1011E, CSD-1012E, CSD-2011E, CSD-2012E, CSD-2022E, CSL-06E, CSL-10E, CSM-0611E, CSM-0611N, CSM-1011E, CSM-1011N, CSM-1021E, CSM-1021N, CSM-2011E, CSM-2011N, CSM-2021E, CSM-2021N		

contactors

GENERAL ELECTRIC (AEG)

power contactors

 <p>1</p>			
Part No.	380239	Ref. No.	00-695507-001
description	power contactor resistive load 20A 230VAC (AC3/400V) 8.4A/4kW main contacts 3NO auxiliary contacts 1NC connection screw connection type LS05 01A type AEG LS05 01A type GE MC1A 301A		

 <p>1</p>			
Part No.	380837	Ref. No.	695507-11
description	power contactor resistive load 20A 400VAC (AC3/400V) 9A/4kW main contacts 3NO auxiliary contacts 1NO connection screw connection type AEG LS0510A type GE MC1A 310A		
For models:	FE, HE		

auxiliary contacts

 <p>1</p>			
Part No.	380242	Ref. No.	695508-2 695570-2
description	auxiliary contact contacts 1NO/1NC for contactors M+LS05 connection screw AC-12 10A type AEG HS05K 11HS type GE MARN 211		
For models:	FE, HE, HE600-HL, HE-P		

HARTLAND

power contactors

 <p>1</p>			
Part No.	580012	Ref. No.	346466-14 346466-16 XNC6X129 XNC6X131
description	contactor resistive load 50A 240VAC 40A/10HP (AC3/240V) 40A/7.46kW main contacts 4NO connection screw clamp/male faston 6.3mm type HCCY4XU04CG		



MOELLER/EATON

power contactors



1

Part No.	380493	Ref. No.	296902-15
description	contactor resistive load 55A 230VAC main contacts 3NO		



1

Part No.	380549	Ref. No.	139270-1
description	power contactor resistive load 20A 230VAC (AC3/400V) 9A/4kW main contacts 3NO auxiliary contacts 1NO connection screw connection type DILM9 10		

For models: AM-12E, AM-12EC, AM-12EF, AM-12ER, H600, H800

accessories for 380549



Part No.	380555	Ref. No.	—
description	auxiliary contact contacts 2NO/2NC AC15 16A for contactors DILEM connection screw type DILA-XHI22		



Part No.	380556	Ref. No.	—
description	auxiliary contact contacts 4NO AC15 16A for contactors DILM 7-32 connection screw type DILA-XHI40		



Part No.	380557	Ref. No.	—
description	auxiliary contact contacts 4NC AC15 16A for contactors DILM 7-32 connection screw type DILA-XHI04		



Part No.	380558	Ref. No.	—
description	auxiliary contact contacts 3NO/1NC AC15 16A for contactors DILM 7-32 connection screw type DILA-XHI31		



Part No.	380559	Ref. No.	—
description	auxiliary contact contacts 1NO/3NC AC15 16A for contactors DILM 7-32 connection screw type DILA-XHI13		



Part No.	380568	Ref. No.	—
description	RC circuit suitable for DILM 9-12 rated 110-240V		

SIEMENS

power contactors



1

Part No.	381387	Ref. No.	E229037
description	power contactor resistive load 22A 230VAC (AC3/400V) 4kW main contacts 3NO auxiliary contacts 1NO connection screw connection type 3RT2016-1AP01		



1

Part No.	380389	Ref. No.	229037
description	power contactor resistive load 22A 230VAC (AC3/400V) 9A/4kW main contacts 3NO auxiliary contacts 1NO connection screw connection type 3RT10-16-1AP01		



1

Part No.	380957	Ref. No.	E927160
description	power contactor resistive load 22A 24VAC (AC3/400V) 12A/5.5kW main contacts 3NO auxiliary contacts 1NO connection screw connection type 3RT10-17-1AB01 50/60Hz		

TELEMECANIQUE (Schneider Electric)

power contactors



1

Part No.	380962	Ref. No.	00-695521-062 695521-62
description	contactor resistive load 20A 230VAC (AC3/400V) 9A/4kW main contacts 4NO connection screw connection type LC1K09004U7		
For models:	ECOMAX-402, ECOMAX-502		

1

Part No.	380966	Ref. No.	695521-1 695521-2
description	power contactor resistive load 20A 230VAC (AC3/400V) 6A/2.2kW main contacts 3NO auxiliary contacts 1NC connection screw connection type LC1K0601P7		



1

Part No.	381146	Ref. No.	695523-26
description	motor protection circuit breaker connection screw clamp setting range 24-30A type GV2ME32		



1

Part No.	380820	Ref. No.	00-695527-002
description	power contactor resistive load 25A 230VAC (AC3/400V) 9A/4kW main contacts 3NO auxiliary contacts 1NO/1NC connection screw connection type LC1D0900M7		

relays

power relays

with bracket mounting



1

Part No.	380312	Ref. No.	00-139321-354 229023
description	power relays FINDER 230VAC 10A 3CO connection male faston 4.8mm bracket mounting dimensions 52x32.2x36.5mm manuf. no. 60.63.8.230.0000		



1

Part No.	380976	Ref. No.	296926-2
description	power contactor resistive load 32A 230VAC (AC3/400V) 18A/7.5kW main contacts 3NO auxiliary contacts 1NO/1NC connection screw connection		



1

Part No.	380139	Ref. No.	929115
description	power relays FINDER 230VAC 16A 2CO connection F6.3 bracket mounting dimensions 68x38.2x35.8mm manuf. no. 62.82.8.230.0000		

motor protection circuit breakers



1

Part No.	380948	Ref. No.	228717-6 695523-5
description	motor protection circuit breaker connection screw clamp setting range 0.63-1A type GV2ME05		



1

Part No.	380403	Ref. No.	900073
description	power relays FINDER 230VAC 16A 3CO connection F6.3 bracket mounting manuf. no. 62.83.8.230.0500		



1

Part No.	380702	Ref. No.	139321-528
description	power relays FINDER 230VAC 16A 3NO connection male faston 6.3mm flange dimensions 36x38x68mm manif. no. 62.83.8.230.0300 230V		



1

Part No.	380185	Ref. No.	139321-686 371450-010
description	power relays Italiana Relè 230VAC 30A 1NO connection F6.3 bracket mounting dimensions 36.5x32.2x51.8mm manif. no. A10-230AC-FA		

time relays

time relays



1

Part No.	380625	Ref. No.	228180-3
description	time relay DOLD CD7839.65/100 time range 0.5-5s 220-240VAC 4A 1NO connection grip connection		
For models:	FM-30, FM-30U, FX, GX, HX, HX-30, HX-30E, HX-30ES, HX-30S, HX-40, HX-40E, HX-40ES, HX-40S, HX-E, HX-ES, HX-S		



1

Part No.	380624	Ref. No.	228180-1
description	time relay DOLD CD7839.65/100 time range 3-30s 220-240VAC 4A 1NO connection grip connection		
For models:	CM1E, FM-30, FM-30U, FX, GX, HX, HX-30, HX-30E, HX-30ES, HX-30S, HX-40, HX-40E, HX-40ES, HX-40S, HX-E, HX-ES, HX-S, WM2E		



1

Part No.	380960	Ref. No.	774103-2
description	time relay DOLD IK817N.81/200 time range 0.02s-300h 12-240V AC/ DC mounting measurements DIN railmm		
For models:	ECOMAX-600, ECOMAX-700		

transformers

encapsulated transformers

with screw connection



1

Part No.	400800	Ref. No.	tran601
description	transformer		

electronic controllers

LOREME

analogue



1

Part No.	379744	Ref. No.	480974
description	electronic controller LOREME type Dsl 94 mounting measurements 66x32mm 230V voltage AC TC/J 0-250°C display without display relay outputs 2 front measurements 70x34mm built-in depth 95mm		



1

Part No.	379745	Ref. No.	480978 845246 845379-1
description	electronic controller kit LOREME type Dsl 94 mounting measurements 66x32mm 230V voltage AC TC/J 0-250°C display without display relay outputs 2 front measurements 70x34mm built-in depth 95mm cable length 2530mm probe L 20mm probe ø 4mm with probe and fastening material		
For models:	CSL-06E, CSL-10E, CSM-0611IE, CSM-0611N, CSM-1011IE, CSM-1011N, CSM-1021IE, CSM-1021N, CSM-2011IE, CSM-2011N, CSM-2021IE, CSM-2021N		
spare parts for	379745		



Part No.	379744	Ref. No.	480974
description	electronic controller LOREME type Dsl 94 mounting measurements 66x32mm 230V voltage AC TC/J 0-250°C display without display relay outputs 2 front measurements 70x34mm built-in depth 95mm		



probes

producer-specific probes

probes





1

Part No.	402906	Ref. No.	775494-1
description	temperature probe NTC 10kOhm cable probe -40 up to +110°C cable°C connection male faston 4.8mm thread probe ø10x30mm cable lengthm		
For models:	AM900, AMS900, FX, GC, GC11, GC12, GC31, GC32, GC41, GC42, GX		



1

Part No.	402905	Ref. No.	00-775612-001 775612-1
description	temperature probe NTC 10kOhm cable PVC probe -40 up to +110°C cable -10 up to 100°C connection coded plug thread probe ø5x35mm cable length 0.2m		
For models:	AM-10, AM-11, AM-141, AM-700, AM900, AM900-10N, AM900-90, AMS900, AMS900-10N, AMX, AMX-10HL, AMX-90, AMX-900, AMXR, AMXR-900, AMXS, AMXS-900, AMXT, AMXTS, AMXX, AMXX-1300, AMXXR, AMXXR-1300, AMXXS, AMXXS-1300, AMXXT, AUP, AUP-90, AUPS, AUXX, AUXX-1300, AUXXL, AUXXL-11N, AUXXLS-11N, AUXXR, AUXXR-1300, AUXXS, AUXXS-1300, AUXXT, AUXXTS, CNA, CNB, CN-Protronic, CNR, CN-Smartronic, CP-Protronic, ECOMAX-602-10, ECOMAX-602-11, ECOMAX-602S-11, ECOMAX-612-10...(Other models you can see in the webshop)		
accessories for	402905		
	Part No.	692218	Ref. No. 00-775489-001 775489-1
	probe clip for temperature probe L 35mm W 24mm H 5mm		



1

Part No.	400910	Ref. No.	139321-591
description	temperature probe NTC 10kOhm cable silicone probe -40 up to +110°C cable -50 up to +180°C connection coded plug thread probe ø4.5x30mm cable length 0.35m		
For models:	CHF45, CHH-50, CHH-60D, CHH-70D, EF-40, EH-60, EH-70		



1

Part No.	402901	Ref. No.	231016 E231016
description	temperature probe NTC 10kOhm cable silicone probe -40 up to +110°C cable -50 up to +180°C connection coded plug thread probe ø5x30mm cable length 0.35m		



1

Part No.	524886	Ref. No.	737006
description	temperature probe NTC cable silicone probe -40 up to +110°C cable -50 up to +180°C connection plug thread M10x1.5 probe ø5x25mm cable length 1.2m		
For models:	104G, 204G, 205G, 2227, 2228, 304G, 304T, 305G		



1

Part No.	379907	Ref. No.	298543-2
description	temperature probe Pt1000 cable silicone probe -50 up to +250°C cable -50 up to +180°C connection male faston 6.3mm thread probe ø6x50mm cable length 1.5m -50 up to +180°C		
For models:	AM-600, AM-600C, AM-600CR, AM-600R, FM-400H, FM-400U, FM-500, FM-500H, UW-105, UW-135H, UW-55		



1

Part No.	378262	Ref. No.	298543-1
description	temperature probe Pt1000 cable silicone probe -50 up to +400°C cable -50 up to +180°C connection F6.3 thread probe ø6x50mm cable length 2.5m		
For models:	UW-125, UW-135, UW-135H, UW-205		



1

Part No.	379906	Ref. No.	00-378584-000 229512-2
description	temperature probe PTC 2kOhm cable TPE probe -50 up to +150°C cable -40 up to +110°C connection coded plug thread probe ø4.8x-30mm cable length 3.5m		
For models:	AMX-E, AMX-ER, AUX-E, AUX-ER, CN, CX, FE-W, FTN, FTX, FX, GX, HX-30E, HX-30ES, HX-40E, HX-40ES, HX-60-EHL, HX-E, HX-ES, UX-30E, UX-30EB, UX-30EH, UX-30ES, UX-30ESB, UX-30ESH, UX-30-McDonalds, UX-60E, UX-60EB, UX-60EH, UX-60EHB		



1

Part No.	400803	Ref. No.	492997
description	temperature probe thermocouple J (Fe-CuNi) cable glass fibre probe -50 up to +750°C cable -50 up to +350°C connection 3-wire thread M8 probe ø5x20mm cable length 2.4m		
For models:	CS-0423E, CS-0423EK, CS-0523E, CS-0523EK, CS-0612E, CS-0612E-A, CS-1012E, CS-1012E-A, CS-1012G, CS-1022E, CS-1022E-A, CS-2012E, CS-2012E-A, CS-2012G, CS-2022E, CS-2022E-A, CS-423E, CS-423K, CSD-0612E, CSD-0612E-A, CSD-0612ET, CSD-1012E, CSD-1012E-A, CSD-1012ET, CSD-1013G, CSD-1022E, CSD-1022E-A, CSD-2012E, CSD-2012E-A, CSD-2012ET, CSD-2013G, CSD-2022E, CSD-2022E-A		



1

Part No.	379793	Ref. No.	N/A
description	temperature probe thermocouple K (NiCr-Ni) cable silicone probe -50 up to 1150°C cable -50 up to +180°C connection 2-wire thread M10x1.5 probe ø3x40mm cable length 2.5m		

1 electric components



core probes



1	Part No.	378452	Ref. No.	F15247515
description core temperature probe NTC 2k0hm cable PVC probe -40 up to +120°C cable -10 up to 100°C connection 2-wire probe ø6x155mm thread cable length 1.5m handle ømm handle length 50mm				

accessories

fasteners



1	Part No.	692218	Ref. No.	00-775489-001 775489-1
description probe clip for temperature probe L 35mm W 24mm H 5mm				
For models: AM-10, AM-11, AM-141, AM-700, AM900, AM900-10N, AM900-90, AMS900, AMS900-10N, AMX, AMX-10HL, AMX-90, AMX-900, AMXR, AMXR-900, AMXS, AMXS-900, AMXT, AMXTS, AMXX, AMXX-1300, AMXXR, AMXXR-1300, AMXXS, AMXXS-1300, AMXXT, AUP, AUP-90, AUPS, AUXX, AUXX-1300, AUXXL, AUXXL-11N, AUXXLS-11N, AUXXR, AUXXR-1300, AUXXS, AUXXS-1300, AUXXT, AUXXTS, CNA, CN-Protronic, CNR, CN-Smartronic, CP-Protronic, CSA, CS-Easytronic, ECOMAX-600, ECOMAX-602-10, ECOMAX-602-11...(Other models you can see in the webshop)				

electronics

EPROMS



1	Part No.	403031	Ref. No.	897547-17
description EPROM				

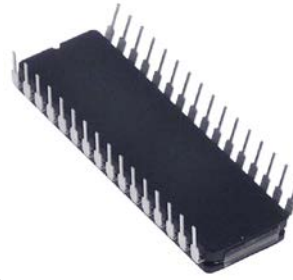

1	Part No.	403046	Ref. No.	775233-3V
description EPROM				



1	Part No.	403245	Ref. No.	139321-731
description EPROM for dishwasher CODE 225032-2				



1	Part No.	403702	Ref. No.	897547-15
description EPROM Rev. 1.6 (04.06.2013)				



1	Part No.	403217	Ref. No.	897503-2
description EPROM type Rev 10.4/5D51 for dishwasher suitable for HOBART CODE 897503-2 17.07.07				
For models: AM-700, AM900, AMS900, AMX-900, AMXR-900, AMXS-900, AMXX-1300, AMXXR-1300, AMXXS-1300, AMXXT, AUXX-1300, AUXXL, AUXXR-1300, AUXXS-1300, AUXXT, GC, GC11, GC12, GC31, GC32, GC41, GC42, UX, UXL, UXLS, UXS, UXT, UXTH, UXTHL, UXTHLS, UXTHS, UXTL, UXTLH, UXTLHS, UXTLS, UXTS				

1

Part No.	403218	Ref. No.	774142-1 774142-1V
description	EPROM type Rev 13/6B17 for dishwasher suitable for HOBART CODE 774142-1 16.10.01		
For models:	AMX-E, AMX-ER, AUX-E, AUX-ER, FE-W, FX, HX-30E, HX-30ES, HX-40E, HX-40ES, HX-E, HX-ES, UX-30E, UX-30EB, UX-30EH, UX-30ES, UX-30ESB, UX-30ESH, UX-30-McDonalds, UX-60E, UX-60EB, UX-60EH, UX-60EHB		



1

Part No.	403216	Ref. No.	897503-1
description	EPROM type Rev 7.06/403A for dishwasher suitable for HOBART CODE 897503-1 24.04.07		
For models:	FX, GX		



1

Part No.	403030	Ref. No.	00-897547-006 897547-6
description	EPROM type REV. L2.3/6101 CODE 897547-6		



1

Part No.	403241	Ref. No.	139321-688
description	EPROM type U61E for dishwasher CODE 81001-3		
For models:	CHH-50, CHH-60D, CHH-70D, EH-60, EH-70		

PCBs





1

Part No.	402904	Ref. No.	00-897501-1
description	control PCB dishwasher AM/AMX 700/900 suitable for HOBART buttons 4		
For models:	AM-700, AM900, AMS900, AMX-900, AMXR-900, AMXS-900, AMXX-1300, AMXXR-1300, AMXXS-1300, AMXXT, AUXX-1300, AUXXL, AUXXR-1300, AUXXS-1300, AUXXT, CNA, CNR, ECOMAX-650, FX, GC, GC11, GC12, GC31, GC32, GC41, GC42, GX, UX, UXL, UXLS, UXS, UXT, UXTH, UXTHL, UXTHLS, UXTHS, UXTL, UXTLH, UXTLHS, UXTLS, UXTS		



1

Part No.	403204	Ref. No.	00-897545-005 897545-5	
description	control PCB dishwasher C502/C602 L 148mm W 126mm without EPROM only for Ecomax			
accessories for	403204			
	Part No.	403030	Ref. No.	00-897547-006 897547-6
	EPROM type REV. L2.3/6101 CODE 897547-6			
	Part No.	403031	Ref. No.	897547-17
	EPROM			

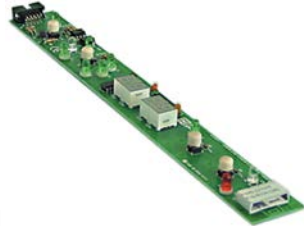



1

Part No.	400897	Ref. No.	139321-456	
description	display PCB dishwasher GS 60			
For models:	CHF45, CHH-50, CHH-60D, CHH-70D, EF-40, EH-60, EH-70			
accessories for	400897			
	Part No.	403250	Ref. No.	139321-684
	ribbon cable 10-pole L 3000mm plug type coded 2 row plug: number of poles 10			





			
1			
Part No.	403032	Ref. No.	00-897560-001 00-897560-002 897560-1 897560-2
description	keypad PCB dishwasher C402(S)-/C502(S)-/C602(S)-xx L 185mm W 35mm suitable for COOKMAX with display buttons 4		
For models:	AM-10, AM-11, AM-141, ECOMAX-402, ECOMAX-502, ECOMAX-602-10, ECOMAX-602-11, ECOMAX-602S-11, ECOMAX-612-10, ECOMAX-612S-10		

			
1			
Part No.	400898	Ref. No.	139321-1012
description	keypad PCB dishwasher LP10/20/30 with display		
accessories for	400898		
	Part No.	402970	Ref. No. 139321-1011
	ribbon cable 10-pole L 1200mm plug type 2 row coded Qty 1m		

			
1			
Part No.	403041	Ref. No.	00-895401-016 895401-16
description	PCB cable length 220mm with relay		
For models:	CSD-0612-UC, CSD-1012-UC, CSD-1022-UC, CSD-2012-UC, CSD-2022-UC		

			
1			
Part No.	403033	Ref. No.	00-897545-001 00-897545-002 00-897545-003 897543-002/00 897545-1 897545-2 897545-3
description	PCB control L 147mm W 125mm without EPROM 230V		
For models:	AM-10, AM-11, AM-141, AM900-10N, AM900-90, AMS900-10N, AMX, AMX-10HL, AMX-90, AMXR, AMXS, AMXT, AMXTS, AMXX, AMXXR, AMXXS, AUP, AUP-90, AUPS, AUXX, AUXXL-11N, AUXXLS-11N, AUXXR, AUXXS, AUXXT, AUXXTS, ECOMAX-402, ECOMAX-502, ECOMAX-602-10, ECOMAX-602-11, ECOMAX-602S-11, ECOMAX-612-10, ECOMAX-612S-10, FP, FX, FX-McDonalds, GP, GX		
accessories for	403033		
	Part No.	403030	Ref. No. 00-897547-006 897547-6
	EPROM type REV. L2.3/6101 CODE 897547-6		
	Part No.	403031	Ref. No. 897547-17
	EPROM		
	Part No.	403702	Ref. No. 897547-15
	EPROM Rev. 1.6 (04.06.2013)		

			
1			
Part No.	401895	Ref. No.	781142-1
description	PCB dishwasher CR type 5E 5A		

			
1			
Part No.	402903	Ref. No.	00-897502-001 897502-1 897502-12 897502-2 897502-22
description	PCB dishwasher GX/FX/HX suitable for HOBART without EPROM		
For models:	AM-700, AM900, AMS900, AMX-900, AMXR-900, AMXS-900, AMXX-1300, AMXXR-1300, AMXXS-1300, AMXXT, AUXX-1300, AUXXL, AUXXR-1300, AUXXS-1300, AUXXT, ECOMAX-650, FX, GC, GC11, GC12, GC31, GC32, GC41, GC42, GX, UX, UXL, UXLS, UXS, UXT, UXTH, UXTHL, UXTHLS, UXTHS, UXTL, UXTLH, UXTLHS, UXTLS, UXTS		

1

Part No.	401946	Ref. No.	324074-1 324250-1 374391-1 785422-1
description	PCB dishwasher HX		
For models:	FX, GX, HX, HX-E, HX-ES, HX-S		



1

Part No.	401893	Ref. No.	00-087714-028-2 87714-28-2
description	PCB time control suitable for HOBART		
For models:	C44A, C44AW, C54A		

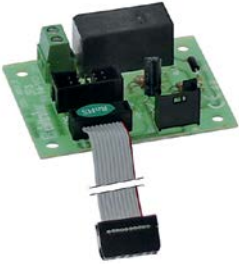





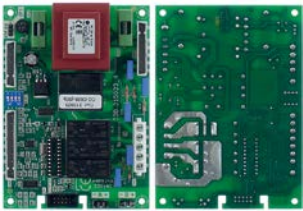

1

Part No.	401049	Ref. No.	139321-691
description	PCB dishwasher LP10/20/30		



1

Part No.	400899	Ref. No.	139321-451 139321-695 215023 E215023
description	power PCB dishwasher LP10/20/30 without EPROM		
For models:	CHF45, CHH-50, CHH-60D, CHH-70D, ECOMAX-601, EF-40, EH-60, EH-70, H66		
accessories for	400899		
	Part No.	400761	Ref. No. —
	plug connector 5-pole		
	Part No.	400900	Ref. No. —
	EPROM CODE 225029-3		
	Part No.	401558	Ref. No. —
	EPROM CODE 81000-1		
	Part No.	403241	Ref. No. 139321-688
	EPROM type U61E for dishwasher CODE 81001-3		
	Part No.	550048	Ref. No. —
	female bullet		



1

Part No.	361870	Ref. No.	01-235011 01-235011-000
description	PCB L 130mm W 100mm		



1

Part No.	403882	Ref. No.	01-515340-001 01-515340-1
description	PCB suitable for HOBART		

keypads

front foils



1

Part No.	403783	Ref. No.	41357
description	front foil dishwasher HOBART/EUROTEC L 144mm W 184mm		



1	Part No.	402321	Ref. No.	296979-4
	description	keypad foil		
	For models:	AM-600, AM-600C, AM-600CR, AM-600R, FM-400H, FM-400U, FM-500, FM-500H, UW-105, UW-135, UW-135H, UW-55		



1	Part No.	698701	Ref. No.	00-897500-001 897500-1
	description	keypad foil dishwasher AMX 900 L 500mm W 41mm		
	For models:	AM900, AMS900, AMX-900, AMXR-900, AMXS-900, AMXX-1300, AMXXR-1300, AMXXS-1300, AMXXT, AUXX-1300, AUXXL, AUXXR-1300, AUXXS-1300, AUXXT, FX, GX, UX, UXL, UXLS, UXS, UXT, UXTH, UXTHL, UXTHLS, UXTHS, UXTL, UXTLH, UXTLHS, UXTLS, UXTS		



1	Part No.	403769	Ref. No.	00-897550-001 897550-1
	description	keypad foil warewashing AM900 L 187mm W 45mm		
	For models:	AM900-10N, AM900-90, AMS900-10N, AMX, AMX-10HL, AMX-90, AMXR, AMXS, AMXT, AMXTS, AMXX, AMXXR, AMXXS, FX, FX-McDonalds, GX		



1	Part No.	694717	Ref. No.	N/A
	description	keypad foil warewashing universal dishwasher black/white suitable for HOBART L 185mm W 144mm buttons 3		

membrane keypads



1	Part No.	402918	Ref. No.	324202
	description	membrane keypad warewashing GX/FX/HX buttons 7 suitable for HOBART L 152mm W 52mm		
	For models:	AMX-E, AMX-ER, AUX-E, AUX-ER, FX, HX-30E, HX-40E, HX-E, UX-30E, UX-30EB, UX-30EH, UX-30ES, UX-30ESB, UX-30ESH, UX-30-McDonalds, UX-60E		

solenoid valves

solenoid valves (water)

ELBI

straight



1	Part No.	373017	Ref. No.	371450-021
	description	solenoid valve single straight 230VAC inlet 3/4" outlet 11.5mm DN10 ELBI		
	spare parts for	373017		
		Part No.	370467	Ref. No. —
			solenoid valve filter suitable for ELBI	



1	Part No.	370246	Ref. No.	240010 371450-020
	description	solenoid valve double straight 230VAC inlet 3/4" outlet 11.5mm t.max. 90°C ELBI plastic output B 0.5l/min flow regulating valve outlet B red		



1	Part No.	370247	Ref. No.	139321-1
	description	solenoid valve triple straight 230VAC inlet 3/4" outlet 11.5mm t.max. 90°C ELBI plastic flow regulating valve inlet orange output B 0.5l/min flow regulating valve outlet B red		
	For models:	GW-600, GW-600S, GW-601, GW-601S		



INTERELEKTRIK

medium temperature: 90°C 90°C 60°C
 ambient temperature: 60°C 25°C 60°C
 duty cycle: 40% 100% 100%

with reducers



Part No.	370676	Ref. No.	01-246164-003 01-246164-3
description	solenoid valve single straight 230VAC inlet 3/4" outlet 10.5mm input 15l/min t.max. 90°C		













Part No.	370675	Ref. No.	00-883658-001 01-246164-001 01-246164-1 883658-1
description	solenoid valve single straight 230VAC inlet 3/4" outlet 10.5mm input 5l/min t.max. 90°C		
For models:	AM900-10N, AM900-90, AMS900-10N, AMX, AMX-10HL, AMX-90, AMX-900, AMXR, AMXR-900, AMXS, AMXS-900, AMXT, AMXTS, AMXX, AMXX-1300, AMXXR, AMXXR-1300, AMXXS, AMXXS-1300, AMXXT, AUP, AUP-90, AUPS, AUXX, AUXX-1300, AUXXL-11N, AUXXLS-11N, AUXXR, AUXXR-1300, AUXXS, AUXXS-1300, AUXXT, AUXXTS, ECOMAX-402, ECOMAX-502, ECOMAX-602-11, ECOMAX-602S-11, ECOMAX-612-10, ECOMAX-612S-10, ECOMAX-700, FP, FX, FX-McDonalds, GP, GX, UX, UXL, UXLS, UXS, UXT...(Other models you can see in the webshop)		
accessories for	370675		
	Part No.	520015	Ref. No. 00-775559-007 00-775559-008 00-775559-013 00-775559-016 139321-125 139321-611 775559-13 775559-16 775559-7 775559-8
	supply hose ID ø 10mm ED ø 17mm L 5m operating p. 20bar burst p. 60bar t.max. 95°C grey Qty 5m		

MÜLLER

medium temperature: 90°C
 duty cycle: 100%



Part No.	370003	Ref. No.	324208-4
description	solenoid valve double angled 230VAC inlet 3/4" outlet 14.5mm DN10 t.max. 90°C duty cycle 100% MÜLLER		
For models:	FX		
spare parts for	370003		
	Part No.	370128	Ref. No. —
	solenoid valve body double angled inlet 3/4" outlet 14.5mm DN10 t.max. 90°C duty cycle 100% MÜLLER 230V double-ways		
	Part No.	371002	Ref. No. —
	solenoid valve holder MÜLLER flange support		
	Part No.	371009	Ref. No. —
	compression spring for solenoid coil		
	Part No.	371011	Ref. No. —
	spare parts kit membrane with long star star height 8mm MÜLLER		
	Part No.	371017	Ref. No. —
	solenoid coil MÜLLER 230VAC connection male faston 6.3mm		
	Part No.	371122	Ref. No. —
	solenoid valve filter ø 19mm H 10mm suitable for MÜLLER		
	Part No.	501161	Ref. No. —
	tap head for solenoid valve holder for solenoid coils		
accessories for	370003		
	Part No.	371010	Ref. No. —
	solenoid coil 230VAC connection with cable cable length 2000mm		
	Part No.	371037	Ref. No. —
	solenoid coil 24VAC 50/60Hz connection male faston 6.3mm		
	Part No.	371038	Ref. No. —
	solenoid coil 230VAC connection appliance plug		



			
1			
Part No.	370001	Ref. No.	324207-1
description	solenoid valve single angled 230VAC inlet 3/4" outlet 14.5mm DN10 t.max. 90°C duty cycle 100% MÜLLER		
For models:	AM3, AMX, AMX-E, AMX-ER, AMX-R, AUX, AUX_, AUX-E, AUX-ER, AUX-R, FE, GX, HE, HE-P, HX, HX-30, HX-30E, HX-40, HX-40E, HX-60-EHL, HX-E, HX-ES, HX-S, UX-30, UX-30B, UX-30E, UX-30EB, UX-30EH, UX-30H, UX-30-McDonalds, UX-60, UX-60B, UX-60E, UX-60EB, UX-60EH, UX-60EHB, UX-60H, UX-60HB, UXD-30		
spare parts for	370001		
	Part No.	370126	Ref. No. —
	solenoid valve body single angled inlet 3/4" outlet 14.5mm DN10 t.max. 90°C duty cycle 100% MÜLLER plastic		
	Part No.	371002	Ref. No. —
	solenoid valve holder MÜLLER flange support		
	Part No.	371009	Ref. No. —
	compression spring for solenoid coil		
	Part No.	371011	Ref. No. —
	spare parts kit membrane with long star star height 8mm MÜLLER		
	Part No.	371017	Ref. No. —
	solenoid coil MÜLLER 230VAC connection male faston 6.3mm		
	Part No.	371122	Ref. No. —
	solenoid valve filter ø 19mm H 10mm suitable for MÜLLER		
accessories for	370001		
	Part No.	371010	Ref. No. —
	solenoid coil 230VAC connection with cable cable length 2000mm		
	Part No.	371037	Ref. No. —
	solenoid coil 24VAC 50/60Hz connection male faston 6.3mm		
	Part No.	371038	Ref. No. —
	solenoid coil 230VAC connection appliance plug		

ROBERTSHAW/INVENSYS

medium temperature: 90°C 90°C 60°C
 ambient temperature: 60°C 25°C 60°C
 duty cycle: 40% 100% 100%

solenoid valves with reducers

single



1

Part No.	374013	Ref. No.	775742-1
description	solenoid valve single straight 230VAC inlet 3/4" outlet 11.5mm 10 Invensys plastic flow regulating valve inlet pink		
For models:	AM-700, GC, GC11, GC12		

2-fold

1

Part No.	371155	Ref. No.	480043-2
description	solenoid valve double straight 230VAC inlet 3/4" outlet 11.5mm input 10l/min 10 EATON (INVENSYS) flow regulating valve inlet white output A 0.25l/min output B 0.25l/min flow regulating valve outlet A white flow regulating valve outlet B white		

RPE



1

Part No.	370857	Ref. No.	00-883658-002 883658-2
description	solenoid valve single straight 230VAC inlet 3/4" outlet 10.5mm input 15l/min t.max. 90°C RPE plastic		
For models:	AM-10, AM-11, AM-141, AMX-10HL, ECOMAX-402, ECOMAX-502, ECOMAX-602-10, FP, FX, FX-McDonalds, GP, GX, UX, UXL, UXLS, UXS, UXT, UXTL, UXTLS, UXTS		

TP



1

Part No.	370021	Ref. No.	240003
description	solenoid valve double straight 230VAC inlet 3/4" outlet 11.5mm DN10 TP flow regulating valve inlet white		
spare parts for	370021		
	Part No.	371013	Ref. No. —
	solenoid coil TP 230VAC 50/60Hz		

Table continues overleaf



accessories for		370021		
	Part No.	371220	Ref. No.	—
reducer TP flow rate 3l/min red tolerance ±15%				
	Part No.	371221	Ref. No.	—
reducer TP flow rate 5.5l/min yellow tolerance ±15%				
	Part No.	371222	Ref. No.	—
reducer TP flow rate 6l/min grey tolerance ±15%				
	Part No.	371223	Ref. No.	—
reducer TP flow rate 10l/min white tolerance ±15%				
	Part No.	371224	Ref. No.	—
reducer TP flow rate 12l/min bronze tolerance ±15%				
	Part No.	371225	Ref. No.	—
reducer TP flow rate 16l/min light brown tolerance ±15%				
	Part No.	371226	Ref. No.	—
reducer TP flow rate 20l/min red tolerance ±15%				
	Part No.	371230	Ref. No.	—
reducer TP flow rate 0.25l/min red tolerance ±25%				
	Part No.	371231	Ref. No.	—
reducer TP flow rate 0.35l/min violet tolerance ±25%				
	Part No.	371232	Ref. No.	—
reducer TP flow rate 0.5l/min orange tolerance ±25%				
	Part No.	371233	Ref. No.	—
reducer TP flow rate 0.8l/min white tolerance ±25%				
	Part No.	371234	Ref. No.	—
reducer TP flow rate 1l/min light blue tolerance ±25%				
	Part No.	371235	Ref. No.	—
reducer TP flow rate 1.2l/min brown tolerance ±25%				
	Part No.	371236	Ref. No.	—
reducer TP flow rate 1.5l/min light brown tolerance ±25%				
	Part No.	371237	Ref. No.	—
reducer TP flow rate 2.5l/min yellow tolerance ±25%				
	Part No.	371238	Ref. No.	—
reducer TP flow rate 3.4l/min dark green tolerance ±25%				
	Part No.	371239	Ref. No.	—
reducer TP flow rate 5l/min black tolerance ±25%				
	Part No.	371240	Ref. No.	—
reducer TP flow rate 8l/min blue tolerance ±20%				



































			
1			
Part No.	370111	Ref. No.	E927001
description	solenoid valve double straight 24VAC inlet 3/4" outlet 11.5mm DN10 TP		
spare parts for	370111		
	Part No.	371035	Ref. No. —
solenoid coil 24VAC			
accessories for	370111		
	Part No.	371220	Ref. No. —
reducer TP flow rate 3l/min red tolerance ±15%			
	Part No.	371221	Ref. No. —
reducer TP flow rate 5.5l/min yellow tolerance ±15%			
	Part No.	371222	Ref. No. —
reducer TP flow rate 6l/min grey tolerance ±15%			
	Part No.	371223	Ref. No. —
reducer TP flow rate 10l/min white tolerance ±15%			
	Part No.	371224	Ref. No. —
reducer TP flow rate 12l/min bronze tolerance ±15%			
	Part No.	371225	Ref. No. —
reducer TP flow rate 16l/min light brown tolerance ±15%			
	Part No.	371226	Ref. No. —
reducer TP flow rate 20l/min red tolerance ±15%			
	Part No.	371230	Ref. No. —
reducer TP flow rate 0.25l/min red tolerance ±25%			
	Part No.	371231	Ref. No. —
reducer TP flow rate 0.35l/min violet tolerance ±25%			
	Part No.	371232	Ref. No. —
reducer TP flow rate 0.5l/min orange tolerance ±25%			
	Part No.	371233	Ref. No. —
reducer TP flow rate 0.8l/min white tolerance ±25%			
	Part No.	371234	Ref. No. —
reducer TP flow rate 1l/min light blue tolerance ±25%			
	Part No.	371235	Ref. No. —
reducer TP flow rate 1.2l/min brown tolerance ±25%			
	Part No.	371236	Ref. No. —
reducer TP flow rate 1.5l/min light brown tolerance ±25%			
	Part No.	371237	Ref. No. —
reducer TP flow rate 2.5l/min yellow tolerance ±25%			

Table continues overleaf



accessories for		370111	
	Part No.	371238	Ref. No. —
reducer TP flow rate 3.4l/min dark green tolerance ±25%			
	Part No.	371239	Ref. No. —
reducer TP flow rate 5l/min black tolerance ±25%			
	Part No.	371240	Ref. No. —
reducer TP flow rate 8l/min blue tolerance ±20%			

  1			
Part No.	370017	Ref. No.	240011
description	solenoid valve single straight 230VAC inlet 3/4" outlet 11.5mm DN10 TP p max 10bar		
spare parts for	370017		
	Part No.	371013	Ref. No. —
solenoid coil TP 230VAC 50/60Hz			
accessories for	370017		
	Part No.	371220	Ref. No. —
reducer TP flow rate 3l/min red tolerance ±15%			
	Part No.	371221	Ref. No. —
reducer TP flow rate 5.5l/min yellow tolerance ±15%			
	Part No.	371222	Ref. No. —
reducer TP flow rate 6l/min grey tolerance ±15%			
	Part No.	371223	Ref. No. —
reducer TP flow rate 10l/min white tolerance ±15%			
	Part No.	371224	Ref. No. —
reducer TP flow rate 12l/min bronze tolerance ±15%			
	Part No.	371225	Ref. No. —
reducer TP flow rate 16l/min light brown tolerance ±15%			
	Part No.	371226	Ref. No. —
reducer TP flow rate 20l/min red tolerance ±15%			
	Part No.	371230	Ref. No. —
reducer TP flow rate 0.25l/min red tolerance ±25%			
	Part No.	371231	Ref. No. —
reducer TP flow rate 0.35l/min violet tolerance ±25%			
	Part No.	371232	Ref. No. —
reducer TP flow rate 0.5l/min orange tolerance ±25%			
	Part No.	371233	Ref. No. —
reducer TP flow rate 0.8l/min white tolerance ±25%			
	Part No.	371234	Ref. No. —
reducer TP flow rate 1l/min light blue tolerance ±25%			

accessories for		370017	
	Part No.	371235	Ref. No. —
reducer TP flow rate 1.2l/min brown tolerance ±25%			
	Part No.	371236	Ref. No. —
reducer TP flow rate 1.5l/min light brown tolerance ±25%			
	Part No.	371237	Ref. No. —
reducer TP flow rate 2.5l/min yellow tolerance ±25%			
	Part No.	371238	Ref. No. —
reducer TP flow rate 3.4l/min dark green tolerance ±25%			
	Part No.	371239	Ref. No. —
reducer TP flow rate 5l/min black tolerance ±25%			
	Part No.	371240	Ref. No. —
reducer TP flow rate 8l/min blue tolerance ±20%			























  1			
Part No.	370025	Ref. No.	139321-1
description	solenoid valve triple straight 230VAC inlet 3/4" outlet 11.5mm DN10 TP		
spare parts for	370025		
	Part No.	371013	Ref. No. —
solenoid coil TP 230VAC 50/60Hz			
accessories for	370025		
	Part No.	371220	Ref. No. —
reducer TP flow rate 3l/min red tolerance ±15%			
	Part No.	371221	Ref. No. —
reducer TP flow rate 5.5l/min yellow tolerance ±15%			
	Part No.	371222	Ref. No. —
reducer TP flow rate 6l/min grey tolerance ±15%			
	Part No.	371223	Ref. No. —
reducer TP flow rate 10l/min white tolerance ±15%			
	Part No.	371224	Ref. No. —
reducer TP flow rate 12l/min bronze tolerance ±15%			
	Part No.	371225	Ref. No. —
reducer TP flow rate 16l/min light brown tolerance ±15%			
	Part No.	371226	Ref. No. —
reducer TP flow rate 20l/min red tolerance ±15%			
	Part No.	371230	Ref. No. —
reducer TP flow rate 0.25l/min red tolerance ±25%			

Table continues overleaf



accessories for		370025		
	Part No.	371231	Ref. No.	—
	reducer TP flow rate 0.35l/min violet tolerance ±25%			
	Part No.	371232	Ref. No.	—
	reducer TP flow rate 0.5l/min orange tolerance ±25%			
	Part No.	371233	Ref. No.	—
	reducer TP flow rate 0.8l/min white tolerance ±25%			
	Part No.	371234	Ref. No.	—
	reducer TP flow rate 1l/min light blue tolerance ±25%			
	Part No.	371235	Ref. No.	—
	reducer TP flow rate 1.2l/min brown tolerance ±25%			
	Part No.	371236	Ref. No.	—
	reducer TP flow rate 1.5l/min light brown tolerance ±25%			
	Part No.	371237	Ref. No.	—
	reducer TP flow rate 2.5l/min yellow tolerance ±25%			
	Part No.	371238	Ref. No.	—
	reducer TP flow rate 3.4l/min dark green tolerance ±25%			
	Part No.	371239	Ref. No.	—
	reducer TP flow rate 5l/min black tolerance ±25%			
	Part No.	371240	Ref. No.	—
	reducer TP flow rate 8l/min blue tolerance ±20%			

solenoid valves with reducers

	1		
Part No.	370628	Ref. No.	00-139321-65
description	solenoid valve double straight 230VAC inlet 3/4" input 16l/min DN10 TP plastic outlet 11.5mm		

	1		
Part No.	370245	Ref. No.	E927242
description	solenoid valve single straight 24VAC inlet 3/4" outlet 11.5mm input 16l/min t.max. 90°C TP plastic flow regulating valve inlet light brown		

various

	1		
Part No.	370641	Ref. No.	00-775897-001 775897-1
description	solenoid valve 220-240VAC outlet 10mm plastic inlet 10mm		
For models:	ECOMAX-402, ECOMAX-502, ECOMAX-602S-11, ECOMAX-612S-10, FX, FX-McDonalds		

metal

ASCO

2-way

	1		
Part No.	370121	Ref. No.	173863
description	solenoid valve 2-ways 230VAC connection 1/2" L 70mm DN 16mm slide-on receptacle DIN -20° up to 85°C Asco type series 210 (positively actuated) coil type 400425-217 membranes NBR (water) p max 9bar valve set A		
For models:	102-G, 103G, 104G, 201G, 202-G, 203G, 204G, 205G, 2222, 2226, 2227, 2228, 301G, 302-G, 303G, 304G, 304T, 305G, AM-12E, AM-12EC, AM-12EF, AM-12ER, AM-600CR, AM-600R, UW-135, UW-135H		

	1		
Part No.	370200	Ref. No.	296795-1
description	solenoid valve 2-ways 230VAC connection 3/4" L 71mm DN 19mm slide-on receptacle DIN -20° up to 85°C Asco type series 222 (positively actuated) coil type 400425-117 membranes NBR (water) p max 20bar p min 0.35bar valve set F		
For models:	AMX, AMX-E, AMX-ER, AMX-R, AUX_, AUX-E, AUX-ER, AUX-R		



solenoid valves steam (water)

2-way



1

Part No.	370263	Ref. No.	00-168909-001 168909-1 2967951-1
description	solenoid valve 2-ways 230VAC inlet 3/4" outlet 3/4" connection 3/4" L 72mm DN 19mm slide-on receptacle DIN -20° up to 184°C Asco type series 222 (positively actuated) coil type 400426-117 membranes PTFE (water/steam) p max 9bar valve set H		
For models:	AM-600, AM-600C, AM-600CR, AM-600R, AMX, AMX-E, AMX-ER, AMX-R, AUX, AUX-E, AUX-ER, AUX-R, UW-100, UW-105, UW-135, UW-135H, UX-30, UX-30B, UX-30E, UX-30EB, UX-30ES, UX-30ESB, UX-30S, UX-30SB, UX-60, UX-60B, UX-60E, UX-60EB		

spare parts and accessories

kits



1

Part No.	371143	Ref. No.	228894-1 228894-11
description	valve insert for solenoid valve with accessories		



1

Part No.	371110	Ref. No.	173863-11
description	valve insert type A size 1/2" service kit		
For models:	2226, 2227, AM-12E, AM-12EC, AM-12EF, AM-12ER, AM-600, AM-600C, AM-600CR, AM-600R		

drain valves



1

Part No.	370642	Ref. No.	00-774683-001 774683-1
description	drain solenoid valve 230V 50/60Hz single inlet 40mm outlet 40mm 26 1-ways		
For models:	CN, CNA, CNB, CNR, CSA, EWB-S, FTN		



1

Part No.	370621	Ref. No.	323785-1 323785-11 378562-1
description	drain solenoid valve 230V 50Hz single inlet 17mm outlet 17mm 11.5		
For models:	FE-W, FX, GX, HX, HX-30, HX-30E, HX-30ES, HX-30S, HX-40, HX-40E, HX-40ES, HX-40S, HX-60-EHL, HX-E, HX-ES, HX-S, UX-30ES, UX-30ESB, UX-30ESH, UX-30-McDonalds, UX-30S, UX-30SB, UX-30SH		



1

Part No.	370720	Ref. No.	323592-1
description	drain solenoid valve straight 230V 50/60Hz single inlet 17mm outlet 19mm 10 plastic		
For models:	AMX-ER, AMX-R, AUX-ER, AUX-R, CN, CNA, CNB, CNR, CR, CSA, FTN		



1

Part No.	370721	Ref. No.	323785-12 323785-2
description	drain solenoid valve straight 240V 50Hz single inlet 17mm outlet 19mm 10 plastic		
For models:	FE-W, FX, GX, HX, HX-30, HX-30E, HX-30ES, HX-30S, HX-40, HX-40E, HX-40ES, HX-40S, HX-60-EHL, HX-E, HX-ES, HX-S, UX-30ES, UX-30ESB, UX-30ESH, UX-30-McDonalds, UX-30S, UX-30SB, UX-30SH		

pressure switches

for warewashing

ø 58mm with male faston 6.3mm

with connection horizontal



1

Part No.	541002	Ref. No.	139321-452
description	pressure control pressure range 110/60mbar connection 6mm ø 58mm pressure connection horizontal warewashing pressure connection ø 6mm		

1

Part No.	541001	Ref. No.	139321-521
description	pressure control pressure range 35/17mbar connection 6mm ø 58mm pressure connection horizontal warewashing		



1

Part No.	541003	Ref. No.	139321-23 139321-833
description	pressure control pressure range 55/35mbar connection 6mm ø 58mm pressure connection horizontal warewashing pressure connection ø 6mm		
For models:	GE-400, GF-60, GF-60S, GW-600, GW-600S, GW-601, GW-601S		

ø 79mm with coded plug

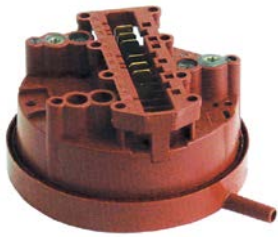

1

Part No.	541321	Ref. No.	231981-2 231981-6
description	pressure control 2 pressure ranges pressure range 35/20 80/60mbar connection 6mm ø 79mm pressure connection horizontal warewashing suitable for HOBART pressure connection ø 6mm		
For models:	AMX, AMX-R, AUX, AUX_, AUX-R, CN, CNB, FTN, UX-30, UX-30B, UX-30H, UX-30-McDonalds, UX-30S, UX-30SB, UX-30SH, UX-60, UX-60B, UXD-30		

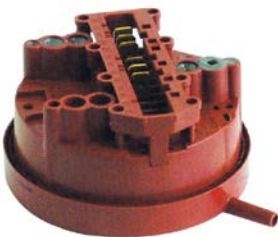

1

Part No.	541318 ¹	Ref. No.	378758-2 378758-6
description	pressure control 2 pressure ranges pressure range 35/25 80/60mbar connection 6mm ø 79mm with gold contacts for electric machines pressure connection horizontal warewashing suitable for HOBART pressure connection ø 6mm		
For models:	AMX-E, AMX-ER, AUX-E, AUX-ER, CN, CNB, FTN, UX-30E, UX-30EB, UX-30EH, UX-30ES, UX-30ESB, UX-30ESH, UX-30-McDonalds, UX-60E, UX-60EB		

¹with gold contacts for electronically controlled equipment

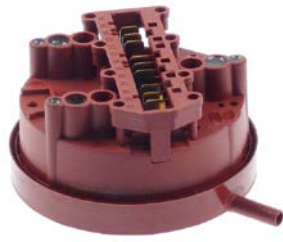

1

Part No.	541902 ¹	Ref. No.	378760-002 378760-2
description	pressure control 3 pressure ranges pressure range 145/120 230/200 280/250mbar connection 6mm ø 79mm pressure connection horizontal with gold contacts for electric machines warewashing		
For models:	CR, CR-F		

¹with gold contacts for electronically controlled equipment

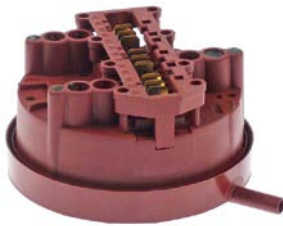

1

Part No.	541904	Ref. No.	378758-8
description	pressure control 3 pressure ranges pressure range 145/120 260/230 385/350mbar connection 6mm ø 79mm pressure connection horizontal warewashing pressure connection ø 6mm		
For models:	UX-30E, UX-30EB, UX-30EH, UX-30ES, UX-30ESB, UX-30ESH, UX-30-McDonalds		

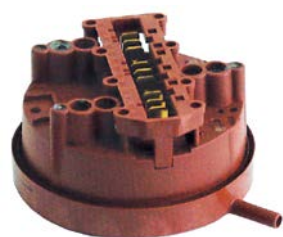

1

Part No.	542151	Ref. No.	378760-6
description	pressure control 3 pressure ranges pressure range 40/25 57/37 125/105mbar connection 6mm ø 78mm pressure connection horizontal warewashing pressure connection ø 6mm		
For models:	FX, GX		

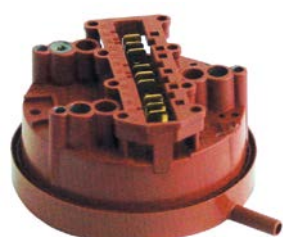

1

Part No.	541320	Ref. No.	231981-1
description	pressure control 3 pressure ranges pressure range 40/25 57/37 125/105mbar connection 6mm ø 79mm pressure connection horizontal warewashing suitable for HOBART pressure connection ø 6mm		
For models:	AM3, CR-F, FE, FX, GX, HE, HE600-HL, HE-P, HX, HX-30, HX-30E, HX-30S, HX-40, HX-40E, HX-40S, HX-S		

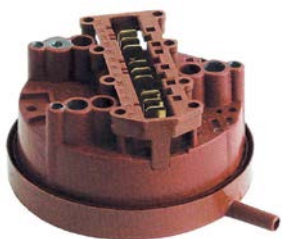

1

Part No.	542136 ¹	Ref. No.	00-378758-001 378758-1
description	pressure control 3 pressure ranges pressure range 40/25 57/37 125/105mbar connection 6mm ø 79mm pressure connection horizontal warewashing suitable for HOBART pressure connection ø 6mm		
For models:	FX, HX-30E, HX-30ES, HX-40E, HX-40ES, HX-60-EHL, HX-E, HX-ES		

¹with gold contacts for electronically controlled equipment

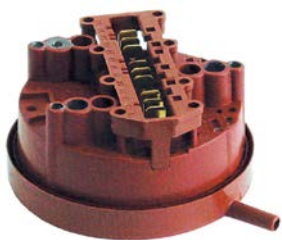

1

Part No.	541317 ¹	Ref. No.	378760-1 378760-3
description	pressure control 3 pressure ranges pressure range 40/25 57/42 125/105mbar connection 6mm ø 79mm pressure connection horizontal warewashing suitable for HOBART		
For models:	AMX, AMX-R, AUX, AUX_, AUX-R, UXD-30		

¹with gold contacts for electronically controlled equipment

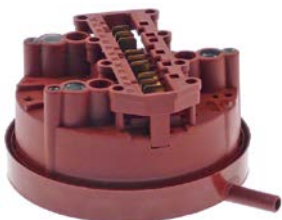

1

Part No.	541316 ¹	Ref. No.	378758-4
description	pressure control 3 pressure ranges pressure range 40/25 57/42 125/105mbar connection 6mm ø 79mm pressure connection horizontal with gold contacts for electric machines warewashing		
For models:	AMX-E, AMX-ER, AUX-E, AUX-ER, FX, GX		

¹with gold contacts for electronically controlled equipment



1

Part No.	541782 ¹	Ref. No.	00-378758-005 378758-5
description	pressure control 3 pressure ranges pressure range 40/25 92/77 160/140mbar connection 6mm ø 79mm pressure connection horizontal with gold contacts for electric machines warewashing suitable for HOBART pressure connection ø 6mm		
For models:	AM-700, AM900, AMS900, AMX-900, AMXR-900, AMXS-900, AMXX-1300, AMXXR-1300, AMXXS-1300, AMXXT, AUXX-1300, AUXXL, AUXXR-1300, AUXXS-1300, AUXXT, ECOMAX-600, ECOMAX-650, ECOMAX-700, FE-W, UX, UX-30E, UX-30EB, UX-30EH, UX-30ES, UX-30ESB, UX-30ESH, UX-30-McDonalds, UX-60E, UX-60EB, UXL, Uxls, Uxs, UXT, UXTH, UXTHL, UXTHLS, UXTHS, UXTL, UXTLH, UXTLHS, UXTLS, UXTS		

¹with gold contacts for electronically controlled equipment

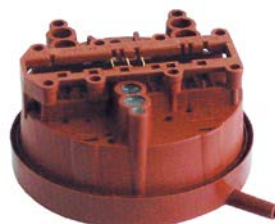

1

Part No.	541319	Ref. No.	231981-3
description	pressure control pressure range 35/20mbar connection 6mm ø 79mm pressure connection horizontal warewashing suitable for HOBART pressure connection ø 6mm		
For models:	FX, GX, HX, HX-30, HX-30E, HX-30S, HX-40, HX-40E, HX-40S, HX-S		

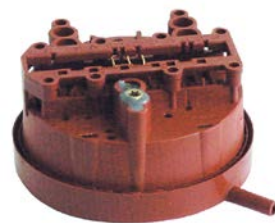

1

Part No.	541315 ¹	Ref. No.	378758-3
description	pressure control pressure range 35/20mbar connection coded plug ø 79mm pressure connection horizontal with gold contacts for electric machines warewashing suitable for HOBART pressure connection ø 6mm		
For models:	FX, GC41, GC42, GX, HX-30E, HX-30ES, HX-40E, HX-40ES, HX-60-EHL, HX-E, HX-ES		

¹with gold contacts for electronically controlled equipment

1

Part No.	541322	Ref. No.	378756-3
description	pressure control pressure range 35/20mbar connection coded plug ø 79mm pressure connection horizontal with gold contacts for electric machines warewashing suitable for HOBART pressure connection ø 6mm		

pressure transmitters



1

Part No.	541149	Ref. No.	00-775866-202 775866-1
description	pressure transmitter pressure range 0-30mbar output voltage 0.5-3.5VDC input voltage 5VDC max 200mbar		
For models:	GC11, GC12, GC31, GC32, GC41, GC42		



1

Part No.	541786	Ref. No.	00-775866-002 775866-02 775866-2
description	pressure transmitter pressure range 0-50mbar output voltage 0.5-3.5VDC input voltage 5VDC max 200mbar		
For models:	AM-10, AM-11, AM-141, AM900-10N, AM900-90, AMS900-10N, AMX, AMX-10HL, AMX-90, AMXR, AMXS, AMXT, AMXTS, AMXX, AMXXR, AMXXS, AUP, AUP-90, AUPS, AUXX, AUXXL-11N, AUXLS-11N, AUXXR, AUXXS, AUXXT, AUXXTS, ECOMAX-402, ECOMAX-502, ECOMAX-602-10, ECOMAX-602-11, ECOMAX-602S-11, ECOMAX-612-10, ECOMAX-612S-10, FP, FX, FX-McDonalds, GP, GX		
accessories for	541786		
	Part No.	520027	Ref. No. 00-324402-005 00-324402-014 139321-126 324402-14 324402-5
	PVC hose ID ø 4mm ED ø 7mm L 10m thickness 1.5mm t.max. 60°C transparent		

accessories



1

Part No.	541109	Ref. No.	139321-578
description	Y-piece plastic hose ø 8-6-8mm for pressure switch		

electrodes



1

Part No.	361374	Ref. No.	299956-4
description	conductivity probe with thread		
For models:	AM-600, AM-600C, AM-600CR, AM-600R, FM-400H, FM-400U, FM-500, FM-500H, UW-105, UW-135, UW-135H, UW-55		



1

Part No.	402986	Ref. No.	845004
description	hose total length 460mm probe Lmm with level sensor connection F6.3 suitable for BOURGEOIS		
For models:	CS-0612E, CS-0612E-A, CS-1012E, CS-1012E-A, CS-1022E, CS-1022E-A, CS-2012E, CS-2012E-A, CS-2022E, CS-2022E-A, CSD-0612E, CSD-0612E-A, CSD-0612ET, CSD-1012E, CSD-1012E-A, CSD-1012ET, CSD-1022E, CSD-1022E-A, CSD-2012E, CSD-2012E-A, CSD-2012ET, CSD-2022E, CSD-2022E-A		



fans

axial fans

import





1

Part No.	601510 ¹	Ref. No.	230324-1 492994 895459
description	axial fan L 119mm W 119mm H 38mm 230VAC 50/60Hz 22/21W bearing ball bearing connection male faston 6.3mm SUNON temp.-resist. 70°C		
For models:	CS-0423E, CS-0423EK, CS-0523E, CS-0523EK, CS-0612E, CS-0612E-A, CS-1012E, CS-1012E-A, CS-1012G, CS-1022E, CS-1022E-A, CS-2012E, CS-2012E-A, CS-2012G, CS-2022E, CS-2022E-A, CS-423E, CS-423K, CSD-0612E, CSD-0612E-A, CSD-0612-UC, CSD-1012E, CSD-1012E-A, CSD-1012-UC, CSD-1013G, CSD-1022E, CSD-1022E-A, CSD-1022-UC, CSD-2012E, CSD-2012E-A, CSD-2012-UC, CSD-2013G, CSD-2022E, CSD-2022E-A, CSD-2022-UC, CSL-06E, CSL-10E, CSM-0611IE, CSM-0611N, CSM-1011IE, CSM-1011N, CSM-1021IE, CSM-1021N, CSM-2011IE, CSM-2011N, CSM-2021IE, CSM-2021N, CX		

¹with ball bearings

2

Part No.	601080 ¹	Ref. No.	00-230324-001
description	axial fan L 119mm W 119mm H 38mm 230VAC 50/60Hz 23/20W bearing ball bearing connection male faston 2.8mm metal ADDA fan wheel ø 110mm temp.-resist. 70°C		
accessories for	601080		
	Part No.	550898	Ref. No. —
	connecting cable cable length 2000mm connection F 2.8 connection distance 7.9mm for axial flow fan		
	Part No.	692519	Ref. No. —
	guard L 120mm W 120mm plastic		

¹with ball bearings



cross flow fans

cross flow fan with heater battery

roller diameter ø60mm



1

Part No.	601027	Ref. No.	301237
description	cross flow fan roller length 180mm roller ø 60mm motor position right 230V 50Hz 17W heat output 2000W bearing silicone cable length 200mm with temperature limiter 125°C		
spare parts for	601027		
	Part No.	375095	Ref. No. —
	bi-metal thermostat hole distance 18mm switch-off temp. 105°C 1NC 1-pole 16A connection F6.3 2 hole fixing		
	Part No.	375911	Ref. No. —
	bi-metal thermostat switch-off temp. 125°C 1NC 1-pole for cross flow fan		

hot air motors



1

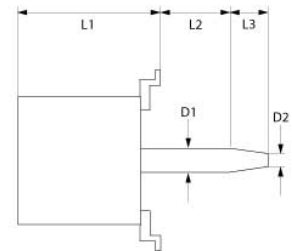

Part No.	500812	Ref. No.	150443-54 233800-04
description	fan motor 220-240/380-415V 3 phase 50Hz 0.26kW 1440rpm speeds 1 D1 ø 17mm D2 ø 13.5mm		
For models:	CO-0612E, CO-1012E, CS-0612E, CS-1012E		



1

Part No.	601805	Ref. No.	07426 844955-01
description	fan motor 230V 1 phase 50/60Hz 0.185kW 1400/1680rpm speeds 2 L1 130mm L2 27mm L3 37mm D1 ø 17mm D2 ø 13.5mm 1A suitable capacitor 5µF/450V Cos(fi) 0.93 type 1079GA2350		
For models:	CS-0612E, CS-1012E, CS-1022E, CS-2012E, CS-2022E, CSD-0612E, CSD-1012E, CSD-1013G, CSD-1022E, CSD-2012E, CSD-2013G, CSD-2022E, CSL-06E, CSL-10E, CSM-06111E, CSM-0611N, CSM-10111E, CSM-1011N, CSM-10211E, CSM-1021N, CSM-20111E, CSM-2011N, CSM-20211E, CSM-2021N		
accessories for	601805		
	Part No.	511605	Ref. No. 322190-1
	shaft seal		

hot air fans

ebm-papst

1

Part No.	601807	Ref. No.	494069
description	hot air fan kit 230V 50W L1 69mm L4 87mm fan wheel ø 151mm type RRL152/0020A92-3030LH-197 ebm-papst		
For models:	CS-0423E, CS-0423EK, CS-0523E, CS-0523EK, CS-423E, CS-423K, CSL-0423E, CSL-0423EK, CSL-0523E, CSL-0523EK, CSL-423E, CSL-423K		
spare parts for	601807		
	Part No.	601808	Ref. No. —
	hot air fan 230/240V 50W L1 69mm L2mm L3mm L4 87mm fan wheel ø 150mm type RRL152/0020A92-3030LH-197 ebm-papst		

pumps

wash and rinse pumps

FIR





pumps

1

Part No.	500598	Ref. No.	139321-490 E929167
description	pump inlet ø 30mm outlet ø 26mm type 5213E2450 230V 50Hz 1 phase 0.22kW 0.1HP L 190mm rotation direction left capacitor 5µF FIR		
For models:	CHH-50, CHH-60D, CHH-70D, EH-60, EH-70		
spare parts for	500598		
	Part No.	365017	Ref. No. 00-226568-009 01-235398 01-235399 139321-941 226568-9
	operating capacitor capacity 5µF 450V tolerance 5% 50/60Hz ambient temperature max. -25 to +85°C ø 28mm L 54mm M8 plastic connection male faston 6.3mm 16.10.08 protection		
	Part No.	502265	Ref. No. 139321-976
	pump cover inlet ø 30mm outlet ø 26mm ID ø 89mm inner height 35mm		
	Part No.	510695	Ref. No. —
	mechanical shaft seal height counter ring 5.5mm ID ø 11mm		
	Part No.	521203	Ref. No. —
	impellor ø 72mm H 18mm thread M7 shaft ø 11mm shaft length 32mm blades 3		
	Part No.	532718	Ref. No. —
	O-ring EPDM thickness 4mm ID ø 80mm Qty 1 pcs		
	Part No.	699372	Ref. No. —
	flange for pump with cover type 5213 L 103mm W 103mm H 69mm		







1

Part No.	499151	Ref. No.	01-240783-001 01-240783-1
description	pump inlet \varnothing 45mm outlet \varnothing 40mm type 3910.1421 230V 50Hz 1 phase 0.37kW 0.5HP L 190mm rotation direction right capacitor 10 μ F FIR		
For models:	ECOMAX-502		
spare parts for	499151		
	Part No.	365015	Ref. No. 00-226568-010 226568-10
	operating capacitor capacity 10 μ F 400V tolerance 5%Hz ambient temperature max. -25 to +85°C \varnothing 35.5mm L 59mm M8 plastic connection male faston 6.3mm protection		
	Part No.	510508	Ref. No. —
	pump cover FIR inlet \varnothing 45mm outlet \varnothing 40mm pump type PU 0.5/3911 turn direction right \varnothing 160mm ID \varnothing 125mm inner height 25mm		
	Part No.	510607	Ref. No. —
	impellor \varnothing 85mm H 29mm shaft intake \varnothing 9x8mm rotation direction right blades 6		
	Part No.	510692	Ref. No. —
	mechanical shaft seal for shaft \varnothing 11mm slide ring ext. \varnothing 24mm slide ring H 13mm counter ring mounting \varnothing 26mm height counter ring 8mm counter ring int. \varnothing 14mm		
	Part No.	521702	Ref. No. —
	pump cover gasket thickness 3.5x4.5mm Qty 1 pcs		



1

Part No.	500400	Ref. No.	774047-1
description	pump inlet \varnothing 45mm outlet \varnothing 40mm type 4255.1600 230V 50Hz 1 phase 0.55kW 0.75HP L 215mm rotation direction right capacitor 12.5 μ F FIR		
For models:	FE, HE, HE600-HL, HE-P		
spare parts for	500400		
	Part No.	365014	Ref. No. —
	operating capacitor capacity 12.5 μ F 450V tolerance 5%Hz ambient temperature max. -25 to +85°C \varnothing 35mm L 70mm M8 plastic connection male faston 6.3mm 45S.C3DS.12.5 protection		
	Part No.	510692	Ref. No. —
	mechanical shaft seal for shaft \varnothing 11mm slide ring ext. \varnothing 24mm slide ring H 13mm counter ring mounting \varnothing 26mm height counter ring 8mm counter ring int. \varnothing 14mm		
	Part No.	521210	Ref. No. —
	impellor \varnothing 96mm H 30mm shaft intake \varnothing 9/8mm seat \varnothing 16mm blades 6		
	Part No.	521506	Ref. No. —
	pump cover FIR inlet \varnothing 45mm outlet \varnothing 40mm turn direction right \varnothing 160mm ID \varnothing 125mm inner height 25mm		
	Part No.	521702	Ref. No. —
	pump cover gasket thickness 3.5x4.5mm Qty 1 pcs		



1

Part No.	499356	Ref. No.	231936-1 775506-1 895499
description	pump type 1314A1910 220/240V 50Hz 1 phase 0.55kW capacitor 12.5µF FIR		
For models:	FE-W, FX, GX, HX, HX-30, HX-30E, HX-30ES, HX-30S, HX-40, HX-40E, HX-40ES, HX-40S, HX-60-EHL, HX-E, HX-ES, HX-S		
accessories for	499356		
	Part No.	Ref. No.	139321-12 323894-12 734530-12 735530-12 896974
	mechanical shaft seal set for shaft ø 12mm ED ø 24mm H 15mm height counter ring 8mm		

HANNING

pumps







1

Part No.	499094	Ref. No.	324913-1 324913-1V
description	pump inlet ø 28mm outlet ø 26mm 220-240V 50Hz HANNING type UP60-343 L 191mm rotation direction left flow rate 110l/min p max 0.48bar 0.22kW capacitor 5µF 1 phase		
For models:	AMX, AMX-900, AMX-E, AMX-ER, AMX-R, AMXR-900, AMXS-900, AMXX-1300, AMXXR-1300, AMXXS-1300, AMXXT, AUX, AUX-, AUX-E, AUX-ER, AUX-R, AUXX-1300, AUXXL, AUXXR-1300, AUXXS-1300, AUXXT, UX, UX-30, UX-30B, UX-30E, UX-30EB, UX-30EH, UX-30H, UX-30-McDonalds, UX-60, UX-60B, UX-60E, UX-60EB, UX-60EH, UX-60EHB, UX-60H, UX-60HB, UXL, UXLS, UXS, UXT, UXTH, UXTHL, UXTHLS, UXTHS, UXTL, UXTLH, UXTLHS, UXTLS, UXTS		



1

Part No.	499147	Ref. No.	00-775854-001 775854-1
description	pump inlet ø 28mm outlet ø 26mm type UP30-324RU 220-240V 50Hz 1 phase 0.14kW L 170mm rotation direction left capacitor 4µF HANNING		
For models:	AM900-10N, AM900-90, AMS900-10N, AMX, AMX-10HL, AMX-90, AMXR, AMXS, AMXT, AMXTS, AMXX, AMXXR, AMXXS, AUP, AUP-90, AUPS, AUXX, AUXXL-11N, AUXXLS-11N, AUXXR, AUXXS, AUXXT, AUXXTS, ECOMAX-402, ECOMAX-502, ECOMAX-602-11, ECOMAX-602S-11, ECOMAX-612-10, ECOMAX-612S-10, FX, FX-McDonalds, GC41, GC42		
spare parts for	499147		
	Part No.	Ref. No.	00-226568-002 226568-2
	operating capacitor capacity 4µF 450V tolerance 5% 50/60Hz ambient temperature max. -25 to +85°C ø 31mm L 58mm M8 plastic connection male faston 6.3mm protection		
	Part No.	Ref. No.	—
	mechanical shaft seal for shaft ø 7mm height counter ring 5mm ID ø 6.75mm ED ø 20mm mounting ø counter ring 18.5/slide ring 20mm		
	Part No.	Ref. No.	—
	O-ring EPDM thickness 3mm ID ø 78mm Qty 1 pcs		
accessories for	499147		
	Part No.	Ref. No.	00-883837-001 883837-1
	protective plate for wash pump suitable for HOBART L 300mm W 200mm		





1			
Part No.	499093	Ref. No.	01-240234-001 01-240234-1
description	pump inlet ø 28mm outlet ø 26mm type UP30-379 220-240V 50Hz 1 phase 0.14kW L 161mm rotation direction left capacitor 4µF HANNING		
For models:	FP, FX, FX-McDonalds, GP, GX		



2			
Part No.	499213	Ref. No.	01-240234-101
description	pump inlet ø 28mm outlet ø 26mm type UP30-439Ru. 220-240V 50Hz 1 phase 0.14kW L 160mm rotation direction left capacitor 4µF HANNING		



1			
Part No.	500534	Ref. No.	00-324093-021 324093-21
description	pump inlet ø 28mm outlet ø 26mm type UP60-184 230V 50Hz 1 phase 0.27kW 0.37HP L 190mm rotation direction left capacitor 5µF HANNING p max 0.77bar Qmax. 160l/min		
For models:	AM3, AMX, AMX-900, AMX-E, AMX-ER, AMX-R, AMXR-900, AMXS-900, AMXX-1300, AMXXR-1300, AMXXS-1300, AMXXT, AUX, AUX_, AUX-E, AUX-ER, AUX-R, AUXR-1300, AUXXL, AUXXR-1300, AUXXS-1300, AUXXT, ECOMAX-402, ECOMAX-650, ECOMAX-700, UX, UXL, UXLS, UXS, UXT, UXTH, UXTHL, UXTHLS, UXTHS, UXTL, UXTLH, UXTLHS, UXTLS, UXTS		
spare parts for	500534		
	Part No.	365017	Ref. No.
			00-226568-009 01-235398 01-235399 139321-941 226568-9
	operating capacitor capacity 5µF 450V tolerance 5% 50/60Hz ambient temperature max. -25 to +85°C ø 28mm L 54mm M8 plastic connection male faston 6.3mm 16.10.08 protection		
	Part No.	507558	Ref. No.
			—
	mechanical shaft seal for shaft ø 7mm height counter ring 5mm ID ø 6.75mm ED ø 20mm mounting ø counter ring 18.5/slide ring 20mm		









1			
Part No.	499068	Ref. No.	324093-1V
description	pump inlet ø 28mm outlet ø 26mm type UP60-313 230V 50Hz 1 phase 0.25kW 0.34HP L 190mm rotation direction left capacitor 5µF HANNING		
spare parts for	499068		
	Part No.	365017	Ref. No.
			00-226568-009 01-235398 01-235399 139321-941 226568-9
	operating capacitor capacity 5µF 450V tolerance 5% 50/60Hz ambient temperature max. -25 to +85°C ø 28mm L 54mm M8 plastic connection male faston 6.3mm 16.10.08 protection		
	Part No.	507558	Ref. No.
			—
	mechanical shaft seal for shaft ø 7mm height counter ring 5mm ID ø 6.75mm ED ø 20mm mounting ø counter ring 18.5/slide ring 20mm		

Table continues overleaf





spare parts for 499068			
	Part No.	532644	Ref. No. —
	O-ring EPDM thickness 3mm ID ø 78mm Qty 1 pcs		



1			
Part No.	499149	Ref. No.	00-324093-021V 324093-21V
description	pump inlet ø 28mm outlet ø 26mm type UP60-315RU 220-240V 50Hz 1 phase 0.25kW L 185mm rotation direction left capacitor 5µF HANNING countries UK		
spare parts for 499149			
	Part No.	365017	Ref. No. 00-226568-009 01-235398 01-235399 139321-941 226568-9
	operating capacitor capacity 5µF 450V tolerance 5% 50/60Hz ambient temperature max. -25 to +85°C ø 28mm L 54mm M8 plastic connection male faston 6.3mm 16.10.08 protection		
	Part No.	507558	Ref. No. —
	mechanical shaft seal for shaft ø 7mm height counter ring 5mm ID ø 6.75mm ED ø 20mm mounting ø counter ring 18.5/slide ring 20mm		
	Part No.	532644	Ref. No. —
	O-ring EPDM thickness 3mm ID ø 78mm Qty 1 pcs		



1			
Part No.	499284	Ref. No.	324914-1 324914-1V
description	pump inlet ø 28mm outlet ø 26mm type UP60-321 Ru. 220-240V 50Hz 1 phase 0.27kW L 190mm rotation direction right capacitor 5µF HANNING		
For models:	UX-30, UX-30B, UX-30E, UX-30EB, UX-30EH, UX-30ES, UX-30ESB, UX-30ESH, UX-30H, UX-30-McDonalds, UX-30S, UX-30SB, UX-30SH, UX-60, UX-60B, UX-60E, UX-60EB, UX-60EH, UX-60EHB, UX-60H, UX-60HB		
spare parts for 499284			
	Part No.	365017	Ref. No. 00-226568-009 01-235398 01-235399 139321-941 226568-9
	operating capacitor capacity 5µF 450V tolerance 5% 50/60Hz ambient temperature max. -25 to +85°C ø 28mm L 54mm M8 plastic connection male faston 6.3mm 16.10.08 protection		
	Part No.	507558	Ref. No. —
	mechanical shaft seal for shaft ø 7mm height counter ring 5mm ID ø 6.75mm ED ø 20mm mounting ø counter ring 18.5/slide ring 20mm		
	Part No.	532644	Ref. No. —
	O-ring EPDM thickness 3mm ID ø 78mm Qty 1 pcs		



1			
Part No.	499112	Ref. No.	774908-108 774908-108V
description	pump inlet ø 32.5mm outlet ø 1" type UP60-341 Ru 220-240/380-415V 50/60Hz 0.16kW HANNING without impellor p max 0.68bar Qmax. 160l/min		



1

Part No.	499000	Ref. No.	781237 781237-1V
description	pump inlet ø 32mm outlet ø 1" type UP60-334 230V 50Hz 1 phase 0.24kW L 250mm rotation direction left capacitor 5µF HANNING p max 0.35bar Qmax. 85l/min		
For models:	CN, CNA, CNB, CNR, CR, CR-F, CSA, FTN		



1

Part No.	499040	Ref. No.	781237-2
description	pump inlet ø 32mm outlet ø 1" type UP60-335 230V 50Hz 1 phase 0.27kW L 250mm rotation direction left capacitor 5µF HANNING p max 0.68bar Qmax. 160l/min		
For models:	CNA, CNB, CNR, CR-F, CSA, FTN		



1

Part No.	499092	Ref. No.	775465-1 897929
description	pump inlet ø outlet ø 26mm type 220-240V 50Hz 1 phase 0.1kW L 135mm capacitor 4µF p max 0.55bar HANNING flange ø 92mm flow rate 45l/min		
For models:	AM900, AMS900, FX, GC, GC31, GC32, GC41, GC42, GX		
accessories for	499092		

	Part No.	510427	Ref. No.	775465-11
		O-ring EPDM thickness 3mm ID ø 83mm Qty 1 pcs		

LGB



1

Part No.	500351	Ref. No.	139321-445
description	pump inlet ø 29mm outlet ø 39mm type X5SX 230V 50Hz 1 phase 0.8kW 1.09HP L 210mm rotation direction right capacitor 16µF LGB		
spare parts for	500351		

	Part No.	365021	Ref. No.	00-226568-013 139321-448 139321-884 226568-13
		operating capacitor capacity 16µF 425V tolerance 5% 50/60Hz ambient temperature max. -25 to +85°C ø 35mm L 73mm single M8 plastic connection male faston 6.3mm 416.10.99 protection		





	Part No.	510703	Ref. No.	139321-446
		mechanical shaft seal for shaft ø 13mm slide ring H 13mm height counter ring 5.5mm ED ø 26mm		



Table continues overleaf



spare parts for 500351			
	Part No.	518294	Ref. No. —
flat gasket rubber ED ø 85mm ID ø 71mm thickness 2mm Qty 1 pcs			
	Part No.	521234	Ref. No. 139321-662
impellor thread M8L ED ø 93mm W 16mm			
	Part No.	523509	Ref. No. 139321-661
deep-groove ball bearing type 6201-2RS shaft ø 12mm ED ø 32mm W 10mm with sealing discs deep-groove ball bearing DIN 625-1			
	Part No.	532537	Ref. No. 139321-469
O-ring EPDM thickness 3.53mm ID ø 113.9mm Qty 1 pcs			



1

Part No.	499150	Ref. No.	00-883833-001 883833-1
description	pump inlet ø 45mm outlet ø 40mm type ZF220SX 230V 50Hz 1 phase 0.4kW L 190mm rotation direction right capacitor 12.5µF LGB		
For models:	AM-10, AM-11, AM-141, ECOMAX-602-10, ECOMAX-602-11, ECOMAX-602S-11		
spare parts for 499150			
	Part No.	521036	Ref. No. 00-883833-010 883833-10
service kit for pump type ZF220SX HOBART 50Hz impellor, pump cover gasket, mechanical shaft seal			
accessories for 499150			
	Part No.	365014	Ref. No. —
operating capacitor capacity 12.5µF 450V tolerance 5%Hz ambient temperature max. -25 to +85°C ø 35mm L 70mm M8 plastic connection male faston 6.3mm 45S.C3DS.12.5 protection			







1

Part No.	500543	Ref. No.	130126 139321-512 E130126
description	pump inlet ø 50mm outlet ø 50mm type ZF400VSX 230V 50Hz 1 phase 0.85kW 1.2HP L 245mm rotation direction right capacitor 16µF LGB		
For models:	ECOMAX-500		
spare parts for 500543			
	Part No.	365021	Ref. No. 00-226568-013 139321-448 139321-884 226568-13
operating capacitor capacity 16µF 425V tolerance 5% 50/60Hz ambient temperature max. -25 to +85°C ø 35mm L 73mm single M8 plastic connection male faston 6.3mm 416.10.99 protection			
	Part No.	509020	Ref. No. 139321-509
impellor ø 104mm H 25mm M8L			
	Part No.	510703	Ref. No. 139321-446
mechanical shaft seal for shaft ø 13mm slide ring H 13mm height counter ring 5.5mm ED ø 26mm			
	Part No.	521548	Ref. No. 139321-889
pump cover LGB inlet ø 50mm outlet ø 50mm			
	Part No.	521734	Ref. No. 139321-887
pump cover bottom part			
	Part No.	532623	Ref. No. —
O-ring EPDM thickness 2.62mm ID ø 120.32mm Qty 1 pcs			









1

Part No.	500361	Ref. No.	139321-548 139321-963
description	pump inlet ø 60mm outlet ø 49mm type ZF400SX 230V 50Hz 1 phase 0.8kW 1HP L 210mm rotation direction right capacitor 16µF LGB		
For models:	CHH-50		
spare parts for	500361		
	Part No.	365021	Ref. No. 00-226568-013 139321-448 139321-884 226568-13
	operating capacitor capacity 16µF 425V tolerance 5% 50/60Hz ambient temperature max. -25 to +85°C ø 35mm L 73mm single M8 plastic connection male faston 6.3mm 416.10.99 protection		
	Part No.	509020	Ref. No. 139321-509
	impellor ø 104mm H 25mm M8L		
	Part No.	510703	Ref. No. 139321-446
	mechanical shaft seal for shaft ø 13mm slide ring H 13mm height counter ring 5.5mm ED ø 26mm		
	Part No.	521547	Ref. No. —
	pump cover LGB inlet ø 60mm outlet ø 50mm supporting pressure M8 turn direction right ø 160mm ID ø 127mm inner height 36mm		
	Part No.	532623	Ref. No. —
	O-ring EPDM thickness 2.62mm ID ø 120.32mm Qty 1 pcs		



1

Part No.	499114	Ref. No.	898253-1
description	pump inlet ø 60mm outlet ø 50mm 220-240V 50Hz 1 phase 0.7kW L 245mm rotation direction right capacitor 16µF		
For models:	AM-700, AM900, AMS900, AMX-900, AMXR-900, AMXS-900, ECOMAX-600, ECOMAX-650		
spare parts for	499114		
	Part No.	365021	Ref. No. 00-226568-013 139321-448 139321-884 226568-13
	operating capacitor capacity 16µF 425V tolerance 5% 50/60Hz ambient temperature max. -25 to +85°C ø 35mm L 73mm single M8 plastic connection male faston 6.3mm 416.10.99 protection		
	Part No.	509020	Ref. No. 139321-509
	impellor ø 104mm H 25mm M8L		
	Part No.	510703	Ref. No. 139321-446
	mechanical shaft seal for shaft ø 13mm slide ring H 13mm height counter ring 5.5mm ED ø 26mm		
	Part No.	521049	Ref. No. 898253-10
	service kit for pump type ZF400VSX LGB impellor, 2x O-ring, mechanical shaft seal, capacitor capacity 16µF		
	Part No.	521547	Ref. No. —
	pump cover LGB inlet ø 60mm outlet ø 50mm supporting pressure M8 turn direction right ø 160mm ID ø 127mm inner height 36mm		
	Part No.	532623	Ref. No. —
	O-ring EPDM thickness 2.62mm ID ø 120.32mm Qty 1 pcs		







OLYMPIA

pumps



1

Part No.	500535	Ref. No.	371450-2
description	pump inlet \varnothing outlet \varnothing 27mm type T70 230V 50Hz 1 phase 0.3kW 0.4HP L 130mm rotation direction right capacitor 6.3 μ F OLYMPIA		
For models:	GF-60, GF-60S		
spare parts for	500535		
	Part No.	365012	Ref. No. 206009
	operating capacitor capacity 6.3 μ F 450V tolerance 5% 50Hz ambient temperature max. -25 to +85°C \varnothing 30mm L 61mm M8 plastic connection male faston 6.3mm protection		
	Part No.	510556	Ref. No. —
	O-ring EPDM thickness 1.78mm ID \varnothing 94.97mm Qty 1 pcs pump type T110		
	Part No.	510693	Ref. No. 139321-12
	mechanical shaft seal for shaft \varnothing 12mm slide ring ext. \varnothing 24mm slide ring H 15.5mm slide ring int. \varnothing 11mm counter ring mounting \varnothing 24mm height counter ring 8mm counter ring int. \varnothing 13.5mm		
	Part No.	521254	Ref. No. —
	impellor \varnothing 81mm H 11mm thread M8L shaft \varnothing 12mm shaft length 28mm blades 6		

wash pump motors





1

Part No.	499106	Ref. No.	324818-34
description	pump motor type 1326 1500W 220-240/380-415V 50/60Hz 3 phase L 330mm W 200mm H 240mm 1400/1700rpm shaft \varnothing 22/25mm		
For models:	CR-F		

booster pumps I









1

Part No.	500359	Ref. No.	139321-651 139321-661
description	pump inlet \varnothing 12 outlet \varnothing 12 type PPL46DX 230V 50Hz 0.33kW capacitor 10 μ F LGB		
For models:	CHF45, CLG-25, EF-40		
spare parts for	500359		
	Part No.	698663	Ref. No. —
	impellor \varnothing 60mm H 12mm with flute shaft intake \varnothing 12mm W 60mm suitable for LGB		
accessories for	500359		
	Part No.	365015	Ref. No. 00-226568-010 226568-10
	operating capacitor capacity 10 μ F 400V tolerance 5%Hz ambient temperature max. -25 to +85°C \varnothing 35.5mm L 59mm M8 plastic connection male faston 6.3mm protection		



1

Part No.	500358	Ref. No.	139321-1085
description	pump inlet \varnothing 3/8" outlet \varnothing 3/8" type PS46 230V 50Hz 0.45kW \varnothing 100mm L 200mm capacitor 10 μ F LGB		
spare parts for	500358		
	Part No.	510713	Ref. No. —
	slide ring for shaft \varnothing 12mm ED \varnothing 24mm H 16mm		
	Part No.	510723	Ref. No. —
	counter ring H 8mm ED \varnothing 26mm ID \varnothing 13.5mm for mechanical shaft seal		
	Part No.	698400	Ref. No. —
	pump cover gasket pump type PS46 thickness 2mm ID \varnothing 66mm Qty 1 pcs		
accessories for	500358		
	Part No.	365015	Ref. No. 00-226568-010 226568-10
	operating capacitor capacity 10 μ F 400V tolerance 5%Hz ambient temperature max. -25 to +85°C \varnothing 35.5mm L 59mm M8 plastic connection male faston 6.3mm protection		
	Part No.	511279	Ref. No. —
	hose connector brass straight thread 3/8" hose \varnothing 12mm Qty 1 pcs		
	Part No.	520202	Ref. No. —
	hose connector nickel-plated brass straight thread 3/8" hose \varnothing 12mm Qty 1 pcs		
	Part No.	520677	Ref. No. —
	hose connector brass straight thread 3/8" hose \varnothing 13mm Qty 1 pcs		



drain pumps

ASKOLL



1

Part No.	500210	Ref. No.	E130123
description	drain pump 230V 40W		



1

Part No.	501541	Ref. No.	139321-1110
description	drain pump 40W 220-240V inlet \varnothing 30mm outlet \varnothing 22mm 50Hz ASKOLL type M231 XP		
For models:	CHH-50, CHH-60D, CHH-70D, EH-60, EH-70		



1

Part No.	500346	Ref. No.	130105
description	drain pump inlet \varnothing 30mm outlet \varnothing 22mm 230V 40W 50Hz ASKOLL type M231 XP with holder		

GRE



1

Part No.	500212	Ref. No.	371450-1
description	drain pump inlet \varnothing mm outlet \varnothing mm 100W 230V 50Hz GRE without lid		
For models:	GF-60, GF-60S		

HANNING



1

Part No.	502290	Ref. No.	00-775854-003 775854-3
description	drain pump 140-160W 220-240V inlet \varnothing 28mm outlet \varnothing 26mm 50-60Hz HANNING type UP30-420 p max 0.65bar Qmax. 115l/min connection coded plug		
For models:	AMXR, AMXXR, AUXXR		



1

Part No.	499148	Ref. No.	00-165653-001 00-883993-001 165653-1 883993-1
description	drain pump 80W 220-240V inlet \varnothing 24mm outlet \varnothing 24mm 50Hz HANNING type BE22B3-197 rotation direction right		
For models:	AM-600, AM-600C, AM-600CR, AM-600R, AM-700, AM900, AM900-10N, AM900-90, AMS900, AMS900-10N, AMX, AMX-10HL, AMX-90, AMXR, AMXS, AMXT, AMXTS, AMXX, AMXXR, AMXXS, AUP, AUP-90, AUPS, AUXX, AUXXL-11N, AUXXLS-11N, AUXXR, AUXXS, AUXXT, AUXXTS, ECOMAX-600, ECOMAX-602S-11, ECOMAX-612-10, ECOMAX-612S-10, ECOMAX-650, ECOMAX-700, FE, FM-30U, GC, GC11, GC12, GC31, GC32, GC41, GC42, HE, HE600-HL, HE-P, UW-105, UW-55		





1

Part No.	499146	Ref. No.	00-883993-012 00-883993-12
description	drain pump inlet \varnothing 24mm outlet \varnothing 24mm 230V 80W 50Hz HANNING type BE22B3-204		
For models:	ECOMAX-402, ECOMAX-502		

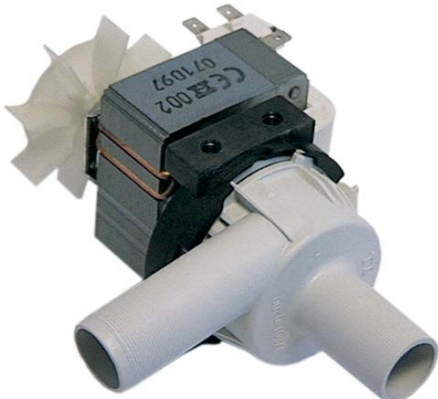

1

Part No.	499319	Ref. No.	01-240010-001 01-240010-1
description	drain pump without lid inlet \varnothing mm outlet \varnothing mm 230V 65W 50Hz HANNING type BE20B2-083		
For models:	FP, FX, FX-McDonalds, GP, GX		



1

Part No.	500042	Ref. No.	165653-1 old version
description	drain pump inlet \varnothing 24mm outlet \varnothing 24mm 230V 80W 50Hz HANNING type KD22B3-679		
spare parts for	500042		
	Part No.	Ref. No.	—
	510168		
	fan wheel shaft intake \varnothing 5mm \varnothing 62mm H 14mm		



1

Part No.	499094	Ref. No.	324913-1 324913-1V
description	pump inlet \varnothing 28mm outlet \varnothing 26mm 220-240V 50Hz HANNING type UP60-343 L 191mm rotation direction left flow rate 110l/min p max 0.48bar 0.22kW capacitor 5 μ F 1 phase		
For models:	AMX, AMX-900, AMX-E, AMX-ER, AMX-R, AMXR-900, AMXS-900, AMXX-1300, AMXXR-1300, AMXXS-1300, AMXXT, AUX, AUX., AUX-E, AUX-ER, AUX-R, AUXR-1300, AUXL, AUXLR-1300, AUXXS-1300, AUXXT, UX, UX-30, UX-30B, UX-30E, UX-30EB, UX-30EH, UX-30H, UX-30-McDonalds, UX-60, UX-60B, UX-60E, UX-60EB, UX-60EH, UX-60EHB, UX-60H, UX-60HB, UXL, UXLS, UXS, UXT, UXTH, UXTHL, UXTHLS, UXTHS, UXTL, UXTLH, UXTLHS, UXTLS, UXTS		
spare parts for	499094		
	Part No.	Ref. No.	00-226568-009 01-235398 01-235399 139321-941 226568-9
	operating capacitor capacity 5 μ F 450V tolerance 5% 50/60Hz ambient temperature max. -25 to +85°C \varnothing 28mm L 54mm M8 plastic connection male faston 6.3mm 16.10.08 protection		



1

Part No.	499127	Ref. No.	845548
description	drain pump inlet \varnothing 30mm outlet \varnothing 24mm 220-240V 30W 50Hz HANNING type DPS25-097		
For models:	CS-0612E, CS-0612E-A, CS-1012E, CS-1012E-A, CS-1022E, CS-1022E-A, CS-2012E, CS-2012E-A, CS-2022E, CS-2022E-A, CSD-0612E, CSD-0612E-A, CSD-0612ET, CSD-1012E, CSD-1012E-A, CSD-1012ET, CSD-1013G, CSD-1022E, CSD-1022E-A, CSD-2012E, CSD-2012E-A, CSD-2012ET, CSD-2013G, CSD-2022E, CSD-2022E-A		



booster pumps II

accessories



1

Part No.	365015	Ref. No.	00-226568-010 226568-10
description	operating capacitor capacity 10µF 400V tolerance 5%Hz ambient temperature max. -25 to +85°C ø 35.5mm L 59mm M8 plastic connection male faston 6.3mm protection		



1

Part No.	365017	Ref. No.	00-226568-009 01-235398 01-235399 139321-941 226568-9
description	operating capacitor capacity 5µF 450V tolerance 5% 50/60Hz ambient temperature max. -25 to +85°C ø 28mm L 54mm M8 plastic connection male faston 6.3mm 16.10.08 protection		
For models:	AMX, AMX-900, AMX-E, AMX-ER, AMX-R, AMXR-900, AMXS-900, AMXX-1300, AMXXR-1300, AMXXS-1300, AMXXT, AUX, AUX_, AUX-E, AUX-ER, AUX-R, AUXX-1300, AUXXL, AUXXR-1300, AUXXS-1300, AUXXT, CHH-70D, ECOMAX-402, ECOMAX-650, ECOMAX-700, EH-70, FE, FE-W, FX, GX, HX-30, HX-30E, HX-30ES, HX-30S, HX-40, HX-40E, HX-40ES, HX-40S, UX, UX-30, UX-30B, UX-30E, UX-30EB, UX-30EH, UX-30ES, UX-30ESB, UX-30H, UX-30-McDonalds, UX-30S, UX-30SB... (Other models you can see in the webshop)		



1

Part No.	365012	Ref. No.	206009
description	operating capacitor capacity 6.3µF 450V tolerance 5% 50Hz ambient temperature max. -25 to +85°C ø 30mm L 61mm M8 plastic connection male faston 6.3mm protection		

condensators & interference suppression filters

operating capacitors

plastic



1

Part No.	365165	Ref. No.	226568-008 226568-8
description	capacitor capacity 12.5µF 450V tolerance 5% 50Hz ambient temperature max. -25 to +85°C ø 35mm L 60mm M8 plastic connection male faston 6.3mm protection		
For models:	FE, FE-W, FX, GX, HE, HE600-HL, HE-P, HX, HX-30, HX-30E, HX-30ES, HX-30S, HX-40, HX-40E, HX-40ES, HX-40S, HX-60-EHL, HX-E, HX-ES, HX-S		



1

Part No.	365167	Ref. No.	226568-3
description	capacitor capacity 6µF 450V tolerance 5% 50Hz ambient temperature max. -25 to +85°C ø 30mm L 58mm M8 plastic connection male faston 6.3mm		
For models:	FE, G10R, G5R, HE-P, HX, HX-60-EHL, HX-E, HX-ES, HX-S, UX-30, UX-30B, UX-30E, UX-30EB, UX-30EH, UX-30ES, UX-30ESB, UX-30ESH, UX-30H, UX-30-McDonalds, UX-30S, UX-30SB, UX-30SH, UX-60, UX-60B, UX-60E, UX-60EB, UX-60EH, UX-60EHB, UX-60H, UX-60HB		



1

Part No.	365015	Ref. No.	00-226568-010 226568-10
description	operating capacitor capacity 10µF 400V tolerance 5%Hz ambient temperature max. -25 to +85°C ø 35.5mm L 59mm M8 plastic connection male faston 6.3mm protection		



1

Part No.	365021	Ref. No.	00-226568-013 139321-448 139321-884 226568-13
description	operating capacitor capacity 16µF 425V tolerance 5% 50/60Hz ambient temperature max. -25 to +85°C ø 35mm L 73mm single M8 plastic connection male faston 6.3mm 416.10.99 protection		
For models:	AM-700, AM900, AM900-10N, AM900-90, AMS900, AMS900-10N, AMX, AMX-10HL, AMX-90, AMX-900, AMXR, AMXR-900, AMXS, AMXS-900, AMXT, AMXTS, CHF45, ECOMAX-600, ECOMAX-612-10, ECOMAX-612S-10, ECOMAX-650, EF-40		



			
1			
Part No.	365031	Ref. No.	00-226568-002 226568-2
description	operating capacitor capacity 4µF 450V tolerance 5% 50/60Hz ambient temperature max. -25 to +85°C ø 31mm L 58mm M8 plastic connection male faston 6.3mm protection		

			
1			
Part No.	365017	Ref. No.	00-226568-009 01-235398 01-235399 139321-941 226568-9
description	operating capacitor capacity 5µF 450V tolerance 5% 50/60Hz ambient temperature max. -25 to +85°C ø 28mm L 54mm M8 plastic connection male faston 6.3mm 16.10.08 protection		
For models:	AMX, AMX-900, AMX-E, AMX-ER, AMX-R, AMXR-900, AMXS-900, AMXX-1300, AMXXR-1300, AMXXS-1300, AMXXT, AUX, AUX_, AUX-E, AUX-ER, AUX-R, AUXX-1300, AUXXL, AUXXR-1300, AUXXS-1300, AUXXT, CHH-70D, ECOMAX-402, ECOMAX-650, ECOMAX-700, EH-70, FE, FE-W, FX, GX, HX-30, HX-30E, HX-30ES, HX-30S, HX-40, HX-40E, HX-40ES, HX-40S, UX, UX-30, UX-30B, UX-30E, UX-30EB, UX-30EH, UX-30ES, UX-30ESB, UX-30H, UX-30-McDonalds, UX-30S, UX-30SB... (Other models you can see in the webshop)		

			
1			
Part No.	365012	Ref. No.	206009
description	operating capacitor capacity 6.3µF 450V tolerance 5% 50Hz ambient temperature max. -25 to +85°C ø 30mm L 61mm M8 plastic connection male faston 6.3mm protection		

			
1			
Part No.	365013	Ref. No.	226568-014 226568-14
description	operating capacitor capacity 8µF 400V tolerance 5%Hz ambient temperature max. -25 to +85°C ø 31.5mm L 55mm M8 plastic connection male faston 6.3mm protection		

<p>metal</p> 			
1			
Part No.	365005	Ref. No.	139321-1084
description	operating capacitor capacity 10µF 400V tolerance 5% 50/60Hz ambient temperature max. -25 to +85°C ø 35mm L 90mm M8 aluminium connection cable 300mm MKP protection IP65		

			
1			
Part No.	365139	Ref. No.	206002
description	operating capacitor capacity 10µF 450V tolerance 5% 60Hz ambient temperature max. -25 up to +70°C ø 40mm L 83mm M8 aluminium connection male faston 6.3mm C.87.8BF2 MKP protection		

<p>filters</p> <p>interference suppression filters</p>			
			
1			
Part No.	365044	Ref. No.	926144
description	interference suppression filter type FC701Y2F 250V 50-60Hz conductor 2 with E connection cable 200mm L 42mm ø 23mm Hmm Wmm plastic Qty 1 pcs		

<p>fuses</p> <p>fine fuses</p>			
			
1			
Part No.	358666	Ref. No.	926283 E926283
description	fine fuse size ø5x20mm 0.315A fast-acting rated 250V Qty 10 pcs		

			
1			
Part No.	358530	Ref. No.	139321-902
description	fine fuse size ø5x20mm 0.8A fast-acting rated 250V Qty 10 pcs		

1

Part No.	358677	Ref. No.	139321-690 E228004
description	fine fuse size ø5x20mm 4A fast-acting rated 250V Qty 10 pcs		



1

Part No.	358594	Ref. No.	228012
description	fine fuse size ø5x20mm 0.16A slow-acting rated 250V Qty 10 pcs		



1

Part No.	358606	Ref. No.	228010 E228010
description	fine fuse size ø5x20mm 4A slow-acting rated 250V Qty 10 pcs		



1

Part No.	358792	Ref. No.	H3090506
description	fine fuse size ø6.3x32mm 10A slow-acting rated 250V Qty 10 pcs		



1

Part No.	358644	Ref. No.	228011
description	fine fuse size ø6.3x32mm 2A slow-acting rated 250V Qty 10 pcs		



1

Part No.	358742	Ref. No.	775570-2
description	fine fuse size ø6.3x32mm 0.8A fast-acting rated 500V Qty 10 pcs		



1

Part No.	358752	Ref. No.	3090506
description	fine fuse size ø6.3x32mm 10A fast-acting rated 500V Qty 10 pcs		



1

Part No.	358751	Ref. No.	00-775570-001 775570-1
description	fine fuse size ø6.3x32mm 6.3A fast-acting rated 500V Qty 10 pcs		
For models:	AMX-900, AMXS-900, AMXX-1300, AMXXT, AUXX-1300, AUXXT, ECOMAX-650, UX, UXL, UXLS, UXS, UXT, UXTH, UXTHL, UXTHLS, UXTHS, UXTL, UXTLS, UXTS		

fine fuse holders



1

Part No.	550499	Ref. No.	139321-600
description	fuse holder suitable fuse ø5x20mm 6.3A rated 500V		



1

Part No.	358026	Ref. No.	00-775548-001 775548-1
description	fuse holder suitable fuse ø6.3x32mm 10A rated 800V L 61mm W 10mm H 65mm cross section 4mm ²		
For models:	AMX-900, AMXS-900, AMXX-1300, AMXXT, AUXX-1300, AUXXT, ECOMAX-402, ECOMAX-502, ECOMAX-650, UX, UXL, UXLS, UXS, UXT, UXTH, UXTHL, UXTHLS, UXTHS, UXTL, UXTLS, UXTS		



1

Part No.	550519	Ref. No.	139321-601
description	cover plate suitable fuseA ratedV connection for fuse holder		

line circuit breakers

miscellaneous



1

Part No.	358019	Ref. No.	301777-3
description	line circuit breaker 1-pole 6A rated 230V connection screw clamp nominal 6A		



electric accessories

cables

accessories

cable glands

cable glands

			
1			
Part No.	551102	Ref. No.	00-227748-001 227748-1
description	cable gland ID ø 10mm mounting ø 12mm Neoprene -30 up to +120°C Qty 1 pcs		
For models:	AM-10, AM-11, AM-141, AM-600, AM-600C, AM-600CR, AM-600R, AM900-10N, AM900-90, AMS900-10N, AMX, AMX-10HL, AMX-90, AMX-E, AMX-ER, AMXR, AMX-R, AMXS, AMXT, AMXTS, AMXX, AMXXR, AMXXS, AUP, AUP-90, AUPS, AUX, AUX_, AUX-E, AUX-ER, AUX-R, AUXR, AUXXL-11N, AUXXLS-11N, AUXXR, AUXXS, AUXXT, AUXXTS, CN-Protronic, CN-Smartronic, CP-Protronic, CS-Easytronic, CX, ECOMAX-602-10, ECOMAX-602-11, ECOMAX-602S-11, ECOMAX-612-10, ECOMAX-612S-10, FM-30, FM-30U...(Other models you can see in the webshop)		

threaded cable glands



screw connections

			
1			
Part No.	524662	Ref. No.	00-695661-004 695661-4
description	cable gland thread M25 cable ø 16mm mounting ø 25mm Qty 1 pcs plastic WS 33		
For models:	ECOMAX-402, ECOMAX-502		

			
1			
Part No.	524663	Ref. No.	00-695661-005 695661-5
description	cable gland thread M32 cable ø 21mm mounting ø 32mm Qty 1 pcs plastic WS 42		
For models:	AM-10, AM-11, AM-141, AM-700, AM900-10N, AM900-90, AMS900-10N, AMX, AMX-10HL, AMX-90, AMX-900, AMXR, AMXR-900, AMXS, AMXS-900, AMXT, AMXTS, AMXX, AMXX-1300, AMXXR, AMXXR-1300, AMXXS, AMXXS-1300, AMXXT, AUP, AUP-90, AUPS, AUX, AUX-1300, AUXL, AUXL-11N, AUXXLS-11N, AUXXR, AUXXR-1300, AUXXS, AUXXS-1300, AUXXT, AUXXTS, ECOMAX-600, ECOMAX-602-10, ECOMAX-602-11, ECOMAX-602S-11, ECOMAX-612-10, ECOMAX-612S-10, ECOMAX-650, ECOMAX-700, UX, UXL, UXLS, UXS...(Other models you can see in the webshop)		

ribbon cables

group 1

			
1			
Part No.	402970	Ref. No.	139321-1011
description	ribbon cable 10-pole L 1200mm plug type 2 row coded Qty 1m		
			
1			
Part No.	400903	Ref. No.	139321-576
description	ribbon cable 10-pole L 2290mm plug type FC-10P raster size 2.54mm		
			
1			
Part No.	403250	Ref. No.	139321-684
description	ribbon cable 10-pole L 3000mm plug type coded 2 row plug: number of poles 10		

terminals

connection terminals with screw/faston connections

			
1			
Part No.	550411	Ref. No.	139321-582 774055-1
description	power terminal block 6-pole max. 40A max 450V connection ø6mm ² / F6.3 temp.-resist. 150°C cross section 6mm ²		
For models:	AMX-900, AMXS-900, AMXX-1300, AMXXT, AUXX-1300, AUXXT, CHF45, CHH-50, CHH-60D, CHH-70D, ECOMAX-650, EF-40, EH-60, EH-70, FE, FE-W, FX, GC, GC11, GC12, GC31, GC32, GC41, GC42, GX, HE, HE600-HL, HE-P, UX, UXL, UXLS, UXS, UXT, UXTL, UXTHL, UXTHLS, UXTHS, UXTL, UXTLS, UXTS		

switch boxes

			
1			
Part No.	524664	Ref. No.	00-229169-007 229169-7
description	gasket for switch box L 415mm W 12mm foam rubber		
For models:	AM-10, AM-11, AM-141, AM900-10N, AM900-90, AMS900-10N, AMX, AMX-10HL, AMX-90, AMXR, AMXS, AMXT, AMXTS, AMXX, AMXXR, AMXXS, AUP, AUP-90, AUPS, AUX, AUXL-11N, AUXXLS-11N, AUXXR, AUXXS, AUXXT, AUXXTS, ECOMAX-602-10, ECOMAX-602-11, ECOMAX-602S-11, ECOMAX-612-10, ECOMAX-612S-10, RRB		



electronic components

inverter



1

Part No.	402902	Ref. No.	916894
description	inverter 200-240V suitable for HOBART		

gas thermostats

PEL

25ST series



1

Part No.	101172	Ref. No.	310137 T310137
description	gas thermostat PEL type 25ST 100-300°C gas inlet M16x1.5 (tube ø 10mm) bypass nozzle ø 0.35mm gas outlet M16x1.5 (tube ø 10/8mm) thermocouple connection M9x1 pilot connection M10x1 capillary pipe 1200mm probe ø 6mm probe L 100mm shaft ø 8x6.5mm shaft L 21/15mm shaft flat upper		

spare parts for 101172

	Part No.	100259	Ref. No.	—
	description	bypass nozzle type PEL22 bore ø 0.35mm thread M6x0.5		

	Part No.	101060	Ref. No.	—
	description	magnet unit standard L 39mm D1 ø 15.4mm D2 ø 11mm suitable for PEL20-21/JUNKERS/EGA		

	Part No.	106200	Ref. No.	—
	description	nut thread M9x1 suitable for PEL 24/25S		

accessories for 101172

	Part No.	100908	Ref. No.	—
	description	union screw thread M10x1 for pipe ø 4mm Qty 1 pcs		

	Part No.	100909	Ref. No.	—
	description	union screw thread M10x1 for pipe ø 6mm Qty 1 pcs		

	Part No.	101246	Ref. No.	—
	description	olive for pipe ø 4mm Qty 1 pcs		



	Part No.	101278	Ref. No.	—
	description	olive for pipe ø 10mm Qty 1 pcs		

	Part No.	101286	Ref. No.	—
	description	olive ID ø 6mm Qty 1 pcs		

	Part No.	101300	Ref. No.	—
	description	union nut thread M16x1.5 tube ø 10mm		

	Part No.	101450	Ref. No.	—
	description	olive for pipe ø 8mm L 12.7mm Qty 1 pcs ED ø 10mm		

	Part No.	101451	Ref. No.	—
	description	union nut thread M16x1.5 tube ø 8mm		

accessories for 101172				
	Part No.	110079	Ref. No.	—
	description	knob dial plate gas thermostat 1-8 silver		
	Part No.	110081	Ref. No.	—
	description	knob ø 70mm shaft ø 8x6.5mm shaft flat universal		

gas valves and ignition boxes

ignition boxes

SIT



1

Part No.	102387	Ref. No.	310197 T310197
description	ignition box SIT type 503EFD electrodes 1 waiting time 1.5s safety time 60s 220/240V 12VA 50-60Hz protection IP20		

ignition parts

ignition units



1

Part No.	102388	Ref. No.	308488 T308488
description	ignition unit outputs 4 230VAC dimensions 111x23x34mm mounting distance 100mm inlet F6.3x0.8 outlet F2.8x0.8 type WAC-T4 0.6VA 50/60Hz		

gas burners

bar burners

bar burners



1

Part No.	104732	Ref. No.	141610 T141610
description	bar burner ø 50mm Wmm Hmm L 350mm		



auxiliary gas parts

screw connections

olives



1

Part No.	100898	Ref. No.	MRTCU800183
description	olive for pipe ø 6mm Qty 1 pcs for pilot burner		
accessories for	100898		
Part No.	100909	Ref. No.	—
description	union screw thread M10x1 for pipe ø 6mm Qty 1 pcs		



1

Part No.	101857	Ref. No.	310275 T310275
description	olive for pipe ø 6mm Qty 1 pcs suitable for 160 series for pilot burner		

equipment-specific units

for slicers

blades

special

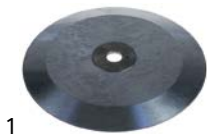

1

Part No.	697810	Ref. No.	N/A
description	slicing machine blade ED ø 298mm seat ø 25mm 1 hole ID ø 25.4mm H 11.8mm 100Cr6 Spezial suitable for HOBART		

for bandsaws

saw blades

width 16mm



1

Part No.	699035	Ref. No.	173101-4
description	saw blade L 1750mm W 16mm thickness 0.5mm tooth spacing 6mm		



1

Part No.	699043	Ref. No.	173101-1
description	saw blade L 2940mm W 16mm thickness 0.5mm tooth spacing 6mm Qty 1 pcs		



1

Part No.	699064	Ref. No.	477016-126
description	saw blade L 3200mm W 16mm thickness 0.5mm tooth spacing 6mm		



1

Part No.	699065	Ref. No.	290868-1
description	saw blade L 3600mm W 16mm thickness 0.5mm tooth spacing 6mm		

for dough mixers

gear wheels



1

Part No.	698362	Ref. No.	55614-1
description	gear wheel ø 60mm shaft intake ø 25mm W 16mm teeth 29 fibre		

miscellaneous



1

Part No.	512413	Ref. No.	012726-02 040991-01 141041
description	bushing L 53mm W 53mm HSM30/HSM40/NCM300/NCM400 mounting distance 41mm		
For models:	A-200N, HSM20, HSM30, HSM40, NCM20, NCM300, NCM400		

for planetary mixers

dough hooks



1

Part No.	698323	Ref. No.	00-295174
description	dough hook model 60 liters shaft intake ø 35/38mm H 495mm flange ø 185mm		
For models:	H600, H600C, H600D, L800, L800C, L800D, M802, ML-104674, ML-104683, ML-104686, ML-104687, ML-104694, ML-104696, V1401		



			
1			
Part No.	698324	Ref. No.	00-437701 295171
description	dough hook model 80 liters shaft intake ø 35/38mm H 570mm flange ø 260mm		
For models:	H600, H600C, H600D, L800, L800C, L800D, M802, ML-104674, ML-104683, ML-104686, ML-104687, ML-104694, ML-104696, V1401		

beaters

			
1			
Part No.	698327	Ref. No.	00-275885
description	beater model 60 liters shaft intake ø 35/38mm W 300mm H 495mm		
For models:	H600, H600C, H600D, L800, L800C, L800D, M802, ML-104674, ML-104683, ML-104686, ML-104687, ML-104694, ML-104696, V1401		

			
1			
Part No.	698328	Ref. No.	00-275448
description	beater model 80 liters shaft intake ø 35/38mm W 350mm H 525mm		
For models:	H600, H600C, H600D, L800, L800C, L800D, M802, ML-104674, ML-104683, ML-104686, ML-104687, ML-104694, ML-104696, V1401		

mixer bowls

			
1			
Part No.	698329	Ref. No.	00-66462
description	mixer bowl model 60 liters ø 460mm H 430mm		
For models:	H600		

			
1			
Part No.	698330	Ref. No.	275690 84920 VML80
description	mixer bowl model 80 liters ø 500mm H 450mm		
For models:	M802, ML-104674, ML-104683, ML-104686, ML-104687, ML-104694, ML-104696, V1401		

beaters

			
1			
Part No.	698325	Ref. No.	00-295154
description	whisk model 60 liters shaft intake ø 35/38mm ø 270mm H 500mm flange ø 160mm		
For models:	H600, H600C, H600D, L800, L800C, L800D, M802, ML-104674, ML-104683, ML-104686, ML-104687, ML-104694, ML-104696, V1401		

			
1			
Part No.	698326	Ref. No.	00-295149
description	whisk model 80 liters shaft intake ø 35/38mm ø 320mm H 530mm flange ø 160mm		
For models:	H600, H600C, H600D, L800, L800C, L800D, M802, ML-104674, ML-104683, ML-104686, ML-104687, ML-104694, ML-104696, V1401		

miscellaneous

			
1			
Part No.	698372	Ref. No.	12749-E
description	guide for spindle suitable for HOBART		



for espresso machines

brewing units

filter holder gaskets

O-rings



1

Part No.	510409	Ref. No.	00-276903-053 00-67500-016 00-67500-118 276903-53 670500-118 67500-16
description	O-ring EPDM thickness 5.34mm ID ø 56.52mm Qty 1 pcs		
For models:	CR-F, CX, ECW, EWB-S, FTN, FTT, FTX, FUX, ML-104674, ML-104683, ML-104686, UW-135, UW-135H, UWX, UX-60, UX-60B, UX-60E, UX-60EB, UX-60EH, UX-60EHB, UX-60H, UX-60HB, UXT, UXTH, UXTHL, UXTHLS, UXTHS, UXTL, UXTLH, UXTLHS, UXTLS, UXTS, V1401		

for coffee grinders

grinding burrs

screws



1

Part No.	560067	Ref. No.	140506-27
description	flat-headed bolt thread M5 thread L 10mm SS DIN 7985/ISO 7045 Qty 20 pcs intake Phillips head ø 8mm head thickness 2mm		
For models:	VPU-100, VPU-6		

for convection ovens/combi-steamers

glass panels



1

Part No.	696425	Ref. No.	844790-2
description	glass panel L 693mm W 613mm for combi-steamer with gasket		

miscellaneous



1

Part No.	698316	Ref. No.	491760
description	duct for glass plate D1 ø 10mm D2 ø 8mm rubber		
For models:	CO-0612E, CO-1012E, CS-0612E, CS-0612E-A, CS-1012E, CS-1012E-A, CS-1012G, CS-1022E, CS-1022E-A, CS-2012E, CS-2012E-A, CS-2012G, CS-2022E, CS-2022E-A, CSD-0612E, CSD-0612E-A, CSD-0612ET, CSD-0612-UC, CSD-1012E, CSD-1012E-A, CSD-1012ET, CSD-1012-UC, CSD-1013G, CSD-1022E, CSD-1022E-A, CSD-1022-UC, CSD-2012E, CSD-2012E-A, CSD-2012ET, CSD-2012-UC, CSD-2013G, CSD-2022E, CSD-2022E-A, CSD-2022-UC, CSL-0423E, CSL-0423EK, CSL-0523E, CSL-0523EK, CSL-06E, CSL-10E, CSL-423E, CSL-423K, CSM-0611IE, CSM-0611N, CSM-1011IE, CSM-1011N, CSM-1021IE, CSM-1021N, CSM-2011IE, CSM-2011N...(Other models you can see in the webshop)		

for dishwashers

drain and intake components

HOBART

drain /intake bodies



1

Part No.	524907	Ref. No.	297986-1
description	drain fitting thread 1 1/4" ED ø 64.5mm ID ø 41mm		
For models:	AM-600, AM-600C, AM-600CR, AM-600R, FM-400H, FM-400U, FM-500, FM-500H, UW-105, UW-135, UW-135H, UW-55		



1

Part No.	518187	Ref. No.	139321-652
description	drain fitting thread 3/4" ID ø 22mm		
For models:	CHF45, CHH-70D, CLG-25, EF-40, EH-70		



1

Part No.	518065	Ref. No.	139321-914
description	filter support H 140mm ø 140mm		
For models:	CHH-50, CHH-60D, CHH-70D, EH-60, EH-70		



1

Part No.	511677	Ref. No.	00-324053-000 00-886639-000
description	flange with gasket ED ø 107mm ID ø 70mm for pump		
For models:	CN-Protronic, CN-Smartronic, CP-Protronic, CR-F, CS-Easytronic, ECOMAX-402, ECOMAX-502, FE-W, FX, GC, GC11, GC12, GC31, GC32, GC41, GC42, GX, HX, HX-30, HX-30E, HX-30ES, HX-30S, HX-40, HX-40E, HX-40ES, HX-40S, HX-60-EHL, HX-E, HX-ES, HX-S		



1

Part No.	511962	Ref. No.	172986-15
description	flat gasket rubber ED ø 62mm ID ø 44mm thickness 0.9mm Qty 1 pcs		
For models:	AM-600, AM-600C, AM-600CR, AM-600R, FM-400H, FM-400U, FM-500, FM-500H, FTX, FUX, UW-105, UW-120, UW-135, UW-135H, UW-200, UW-55, UWX		



1

Part No.	507496	Ref. No.	00-324056-000
description	gasket ED ø 100mm ID ø 80mm		
For models:	CN, CNA, CNB, CN-Protronic, CNR, CN-Smartronic, CP-Protronic, CR, CR-F, CS-Easytronic, ECOMAX-402, ECOMAX-502, FE, FE-W, FTN, FX, GC, GC11, GC12, GC31, GC32, GC41, GC42, GX, HE, HE600-HL, HE-P, HX, HX-30, HX-30E, HX-30ES, HX-30S, HX-40, HX-40E, HX-40ES, HX-40S, HX-60-EHL, HX-E, HX-ES, HX-S, UX-60, UX-60B, UX-60E, UX-60EB		



1

Part No.	524906	Ref. No.	323785-101
description	gasket for drain assembly ø 14mm		
For models:	FX, GX		



1

Part No.	518060	Ref. No.	139321-913
description	gasket rubber ED ø 132mm ID ø 122mm thickness 5mm		
For models:	CHH-50, CHH-60D, CHH-70D, EH-60, EH-70		



1

Part No.	518199	Ref. No.	139321-158
description	intake body		
For models:	GE-400, GW-600, GW-600S, GW-601, GW-601S		



1

Part No.	517404	Ref. No.	00-323802-001 323802-1
description	intake body ED ø 105mm H 110mm ID ø 75mm hose ø 31mm		
For models:	CR, CR-F, ECOMAX-402, ECOMAX-502, FE, GC, GC11, GC12, GC31, GC32, GC41, GC42, HE, HE600-HL, HE-P		



1

Part No.	518064	Ref. No.	139321-912
description	intake body ED ø 140mm ID ø 102mm hose ø 50/60mm		
For models:	CHH-50, CHH-60D, CHH-70D, EH-60, EH-70		

filters



1

Part No.	517584	Ref. No.	00-324768-000
description	filter ø 138mm H 86mm		
For models:	AMX, AMX-900, AMX-E, AMX-ER, AMX-R, AMXR-900, AMXS-900, AMXX-1300, AMXXR-1300, AMXXS-1300, AMXXT, AUX, AUX_, AUX-E, AUX-ER, AUX-R, AUXX-1300, AUXXL, AUXXR-1300, AUXXS-1300, AUXXT, UX, UX-30, UX-30B, UX-30E, UX-30EB, UX-30EH, UX-30ES, UX-30ESB, UX-30ESH, UX-30H, UX-30-McDonalds, UX-30S, UX-30SB, UX-30SH, UX-60, UX-60B, UX-60E, UX-60EB, UX-60EH, UX-60EHB, UX-60H, UX-60HB, UXD-30, UXL, UXLS, UXS, UXT, UXTH, UXTHL...(Other models you can see in the webshop)		



1

Part No.	517586	Ref. No.	01-240051-004 01-240051-4
description	flat filter H 43mm L 525mm W 220mm		
For models:	FX, FX-McDonalds, GX		



			
1			
Part No.	507499	Ref. No.	00-898189-001 898189-1
description	flat filter L 523mm W 253mm H 15mm		
For models:	AM-10, AM-11, AM-141, AM-700, AM900, AM900-10N, AM900-90, AMS900, AMS900-10N, ECOMAX-600, ECOMAX-602-10, ECOMAX-602-11, ECOMAX-602S-11, ECOMAX-612-10, ECOMAX-612S-10, ECOMAX-650		

			
2			
Part No.	510647	Ref. No.	323893-1
description	intake filter ø 163mm H 112mm hole ø 33mm		
For models:	FE, HE, HE-P		

			
1			
Part No.	517581	Ref. No.	229400
description	rectangular filter for dishwasher H 312mm SS L 435mm W 85mm		
For models:	ACW, CX, FTT, FTX, UW-135, UW-135H		

			
1			
Part No.	510040	Ref. No.	139321-50
description	round filters mounting pos. outer		
For models:	GE-400, GW-600, GW-600S, GW-601, GW-601S		

			
1			
Part No.	524830	Ref. No.	01-240630-003 01-240630-3
description	round filters ø 136mm H 47mm		

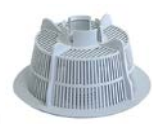
			
1			
Part No.	510041	Ref. No.	139321-51
description	round filters ø 136mm H 75mm		
For models:	GE-400, GW-600, GW-600S, GW-601, GW-601S		

			
1			
Part No.	530788	Ref. No.	00-883582-001 01-297817-1 8123 883582-1
description	round filters ø 154mm H 116mm for model AMX/AUX with ring		
For models:	AMX, AMX-10HL, AMX-90, AMXR, AMXS, AMXT, AMXTS, AMXX, AMXXR, AMXXS, AUP, AUP-90, AUPS, AUXX, AUXXL-11N, AUXXLS-11N, AUXXR, AUXXS, AUXXT, AUXXTS		

			
1			
Part No.	524897	Ref. No.	883733-1
description	round filters ø 160mm H 35mm		

			
1			
Part No.	524681	Ref. No.	324179
description	round filters ø 161mm H 155mm		
For models:	FE-W, FX, GX, HX, HX-30, HX-30E, HX-30ES, HX-30S, HX-40, HX-40E, HX-40ES, HX-40S, HX-60-EHL, HX-E, HX-ES, HX-S		

			
1			
Part No.	502217	Ref. No.	01-240630-001 01-240630-002 01-240630-1 01-240630-2
description	round filters ø 32.5mm H 49mm		
For models:	ECOMAX-402, ECOMAX-502		



overflow pipes



Part No.	698632	Ref. No.	324231
-----------------	--------	-----------------	--------

description	flap for overflow pipe ø 55mm H 13mm		
--------------------	--------------------------------------	--	--

For models:	AMX, AMX-900, AMX-E, AMX-ER, AMX-R, AMXR-900, AMXS-900, AMXX-1300, AMXXR-1300, AMXXS-1300, AMXXT, AUX, AUX_, AUX-E, AUX-ER, AUX-R, AUXX-1300, AUXXL, AUXXR-1300, AUXXS-1300, AUXXT, CR, CR-F, FE-W, FX, GX, HX, HX-30, HX-30E, HX-30ES, HX-30S, HX-40, HX-40E, HX-40ES, HX-40S, HX-60-EHL, HX-E, HX-ES, HX-S, UX, UX-30, UX-30B, UX-30E, UX-30EB, UX-30EH, UX-30ES, UX-30ESB, UX-30ESH, UX-30H, UX-30-McDonalds...(Other models you can see in the webshop)		
--------------------	---	--	--



Part No.	528919	Ref. No.	139321-49
-----------------	--------	-----------------	-----------

description	O-ring EPDM thickness 2.62mm ID ø 20.24mm Qty 1 pcs		
--------------------	---	--	--

For models:	GE-400, GW-600, GW-600S, GW-601, GW-601S		
--------------------	--	--	--



Part No.	510072	Ref. No.	139321-192
-----------------	--------	-----------------	------------

description	O-ring EPDM thickness 3.53mm ID ø 32.93mm Qty 1 pcs		
--------------------	---	--	--



Part No.	510409	Ref. No.	00-276903-053 00-67500-016 00-67500-118 276903-53 670500-118 67500-16
-----------------	--------	-----------------	--

description	O-ring EPDM thickness 5.34mm ID ø 56.52mm Qty 1 pcs		
--------------------	---	--	--

For models:	CR-F, CX, ECW, EWB-S, FTN, FTT, FTX, FUX, ML-104674, ML-104683, ML-104686, UW-135, UW-135H, UWX, UX-60, UX-60B, UX-60E, UX-60EB, UX-60EH, UX-60EHB, UX-60H, UX-60HB, UXT, UXTH, UXTHL, UXTHLS, UXTHS, UXTL, UXTLH, UXTLHS, UXTLS, UXTS, V1401		
--------------------	---	--	--



Part No.	517580	Ref. No.	01-240629-001 01-240629-1 01-240744-001 01-240744-002 01-240744-1 01-240744-2
-----------------	--------	-----------------	--

description	overflow pipe L 160mm ø 90mm		
--------------------	------------------------------	--	--

For models:	ECOMAX-402, ECOMAX-502		
--------------------	------------------------	--	--



1

Part No.	510038	Ref. No.	139321-157
-----------------	--------	-----------------	------------

description	overflow pipe L 190mm ø 25mm		
--------------------	------------------------------	--	--

For models:	GE-400, GW-600, GW-600S, GW-601, GW-601S		
--------------------	--	--	--

accessories for	510038		
------------------------	--------	--	--



Part No.	528919	Ref. No.	139321-49
-----------------	--------	-----------------	-----------

description	O-ring EPDM thickness 2.62mm ID ø 20.24mm Qty 1 pcs		
--------------------	---	--	--



1

Part No.	524480	Ref. No.	323999-1
-----------------	--------	-----------------	----------

description	overflow pipe L 250mm ø 32mm		
--------------------	------------------------------	--	--

For models:	CR, CR-F, FE, HE, HE600-HL, HE-P		
--------------------	----------------------------------	--	--



1

Part No.	524660	Ref. No.	00-883737-001 883737-1
-----------------	--------	-----------------	---------------------------

description	overflow pipe L 270mm ø 32mm		
--------------------	------------------------------	--	--

For models:	AM-10, AM-11, AM-141, ECOMAX-602-10, ECOMAX-602-11, ECOMAX-602S-11, ECOMAX-612-10, ECOMAX-612S-10		
--------------------	---	--	--



1

Part No.	517574	Ref. No.	323534-4
-----------------	--------	-----------------	----------

description	overflow pipe L 305mm with filter ø 155mm tube ø 56mm plastic ID ø 28mm		
--------------------	---	--	--

For models:	AMX-900, AMXR-900, AMXS-900		
--------------------	-----------------------------	--	--





1

Part No.	517579	Ref. No.	898185-1
-----------------	--------	-----------------	----------

description	overflow pipe L 323mm ø 86mm tube ø 35mm plastic ID ø 24mm		
--------------------	--	--	--

For models:	AM-700, ECOMAX-600, ECOMAX-650		
--------------------	--------------------------------	--	--





			
1			
Part No.	524682	Ref. No.	230346 230346-1 230346-1V
description	overflow pipe L 370mm ø 109mm		
For models:	CX, UW-135, UW-135H		
accessories for	524682		
		Part No.	521120 Ref. No. —
	O-ring EPDM thickness 5.34mm ID ø 37.47mm Qty 1 pcs		

			
1			
Part No.	517576	Ref. No.	323534-3
description	overflow pipe L 405mm with filter ø 155mm tube ø 36mm ID ø 28mm		
For models:	AMXX-1300, AMXXR-1300, AMXXS-1300, AMXXT, AUXX-1300, AUXXL, AUXXR-1300, AUXXS-1300, AUXXT		

			
1			
Part No.	517582	Ref. No.	229426-3 229426-3V
description	overflow pipe L 410mm ø 109mm		
For models:	AM-12E, AM-12EC, AM-12EF, AM-12ER, AM-600, AM-600C, AM-600CR, AM-600R, UW-100, UW-105, UWX		

			
1			
Part No.	517578	Ref. No.	323534-1 774412-1
description	overflow pipe L 458mm with filter ø 155mm tube ø 36mm ID ø 28mm		
For models:	AMX, AMX-E, AMX-ER, AMX-R, AUX, AUX_, AUX-E, AUX-ER, AUX-R, UXD-30		

			
1			
Part No.	524921	Ref. No.	323534-2 324666-2
description	overflow pipe L 460mm with filter ø 150mm tube ø 36mm plastic ID ø 28mm		
For models:	CR, CR-F, UX-30, UX-30B, UX-30E, UX-30EB, UX-30EH, UX-30ES, UX-30ESB, UX-30ESH, UX-30H, UX-30-McDonalds, UX-30S, UX-30SB, UX-30SH, UX-60, UX-60B, UX-60E, UX-60EB, UX-60EH, UX-60EHB, UX-60H, UX-60HB, UXT, UXTH, UXTHL, UXTHLS, UXTHS, UXTL, UXTLS, UXTS		

			
1			
Part No.	517577	Ref. No.	323534-6
description	overflow pipe L 467mm with filter ø 155mm tube ø 36mm plastic ID ø 28mm		
For models:	UXT, UXTH, UXTHS, UXTL, UXTLH, UXTLHS, UXTLS, UXTS		

containers

container lids

			
1			
Part No.	524685	Ref. No.	227883
description	lid ø 29mm for dosing container suitable for HOBART		
For models:	CM1E, FX, GX, WM2E		

			
1			
Part No.	542091	Ref. No.	00-775530-050 775530-50
description	lid ø 85mm for salt tank suitable for HOBART H 18mm ID ø 58mm		
For models:	AM900, AM900-10N, AM900-90, AMS900, AMS900-10N, AMX, AMX-10HL, AMX-90, AMX-900, AMXR, AMXR-900, AMXS, AMXS-900, AMXT, AMXTS, AMXX, AMXX-1300, AMXXR, AMXXR-1300, AMXXS, AMXXS-1300, AMXXT, AUP, AUP-90, AUPS, AUXX, AUXX-1300, AUXXL, AUXXL-11N, AUXXLS-11N, AUXXR, AUXXR-1300, AUXXS, AUXXS-1300, AUXXT, AUXXTS, FP, FX, FX-McDonalds, GP, GX, UX, UXL, UXLS, UXS, UXT, UXTH, UXTHL, UXTHLS, UXTHS...(Other models you can see in the webshop)		



dosing containers



1

Part No.	361881	Ref. No.	231969-1 231969-2
description	container kit L 335mm W 105mm H 25mm for rinse aid		
For models:	FX, GX		



1

Part No.	361893	Ref. No.	231969
description	container L 335mm W 105mm H 25mm for rinse aid		
For models:	FX, GX		

salt tanks



1

Part No.	524177	Ref. No.	139321-737
description	lid ø 69mm H 20mm for salt tank ID ø 50mm		
accessories for	524177		
	Part No.	524148	Ref. No. —
	O-ring EPDM thickness 3.53mm ID ø 40.86mm Qty 1 pcs		







1

Part No.	510018	Ref. No.	139321-739
description	nut ø 92mm H 10.5mm for salt tank ID ø 64mm		



1

Part No.	510032	Ref. No.	139321-740
description	salt tank without gasket new model		
spare parts for	510032		
	Part No.	506015	Ref. No. 139321-738 371450-64 456052
	O-ring EPDM thickness 3.53mm ID ø 39.69mm Qty 1 pcs		
	Part No.	510018	Ref. No. 139321-739
	nut ø 92mm H 10.5mm for salt tank ID ø 64mm		
	Part No.	510071	Ref. No. 139321-597
	flat gasket rubber ED ø 81mm ID ø 68mm thickness 3mm for salt tank Qty 1 pcs		
	Part No.	524177	Ref. No. 139321-737
	lid ø 69mm H 20mm for salt tank ID ø 50mm		

accessories



1

Part No.	510071	Ref. No.	139321-597
description	flat gasket rubber ED ø 81mm ID ø 68mm thickness 3mm for salt tank Qty 1 pcs		



boilers

boilers for dishwashers

			
1			
Part No.	518576	Ref. No.	139321-844
description	boiler		

			
1			
Part No.	504375	Ref. No.	01-240791-001 01-240791-1
description	boiler ø 133mm L 420mm flange 3 hole flange flange ø 47.5mm		
For models:	AM-10, AM-11, AM-141, ECOMAX-502, ECOMAX-602-10		
accessories for	504375		
			
	Part No.	504379	Ref. No. 00-774512-001 774512-1
	plug for draining ø 10mm L 18mm		
			
	Part No.	530821	Ref. No. 00-774080-001 774080-1
	silicone hose ID ø 10mm ED ø 15mm L 1m thickness 2.5mm operating pressure without pressure burst pressure non defined t.max. 200°C transparent Shore 60°		

			
1			
Part No.	519432	Ref. No.	774250-1
description	boiler ø 150mm L 500mm		
For models:	HE, HE600-HL		

accessories

			
1			
Part No.	524908	Ref. No.	00-774808-001 774808-1
description	blind plug for boiler L 69mm W 17mm		
For models:	AM-700, AMX-900, AMXR-900, AMXS-900, AMXX-1300, AMXXR-1300, AMXXS-1300, AMXXT, AUXX-1300, AUXXL, AUXXR-1300, AUXXS-1300, AUXXT, CN, CNA, CNB, CN-Protronic, CNR, CN-Smartronic, CP-Protronic, CR, CR-F, CSA, CS-Easytronic, ECOMAX-600, ECOMAX-650, ECOMAX-700, ECOMAX-800, ECW, FTN, FTX, UX, UXL, UXLS, UXS, UXT, UXTH, UXTHL, UXTHLS, UXTHS, UXTL, UXTLH, UXTLHS, UXTLS, UXTS		

			
1			
Part No.	511654	Ref. No.	230994
description	boiler gasket D1 ø 260mm D2 ø 215mm thickness 2mm 10 holes rubber suitable for HOBART		
For models:	ACW, CR-F, CX, FTN, FTT, FTX, FUX, UWX		

			
1			
Part No.	518121	Ref. No.	226894-1
description	boiler gasket ø 249mm ID ø 235mm thickness 7mm		
For models:	AM-12E, AM-12EC, AM-12EF, AM-12ER, AM-600, AM-600C, AM-600CR, AM-600R, UW-100, UW-105, UW-135, UW-135H		

			
1			
Part No.	524905	Ref. No.	228602
description	gasket for boiler ø 145mm L 187mm W 174mm thickness 7mm hole ø 7mm		
For models:	FM-30, FM-30U, FM-400H, FM-400U, FM-500, FM-500H, UW-55		

			
1			
Part No.	504378	Ref. No.	01-240452-001 01-240452-1
description	hose connector thread 1/8" thread L 44mm hose ø 5mm		
For models:	AM-10, AM-11, AM-141, AM900-10N, AM900-90, AMS900-10N, AMX, AMX-10HL, AMX-90, AMXR, AMXR-90, AMXS, AMXS-90, AMXT, AMXTS, AMXX, AMXXR, AMXXS, AUP, AUP-90, AUPS, AUXX, AUXXL-11N, AUXXLS-11N, AUXXR, AUXXS, AUXXT, AUXXTS, ECOMAX-602-10, ECOMAX-602-11, ECOMAX-602S-11, ECOMAX-612-10, ECOMAX-612S-10		

			
1			
Part No.	504379	Ref. No.	00-774512-001 774512-1
description	plug for draining ø 10mm L 18mm		
For models:	AM-10, AM-11, AM-141, AM-700, AM900, AM900-10N, AM900-90, AMS900, AMS900-10N, AMX, AMX-10HL, AMX-90, AMXR-900, AMXS, AMXS-900, AMXT, AMXTS, AMXX, AMXX-1300, AMXXR, AMXXR-1300, AMXXS, AMXXS-1300, AMXXT, AUP, AUP-90, AUPS, AUXX, AUXX-1300, AUXXL, AUXXL-11N, AUXXLS-11N, AUXXR, AUXXR-1300, AUXXS, AUXXS-1300, AUXXT, AUXXTS, ECOMAX-402, ECOMAX-502, ECOMAX-600, ECOMAX-602-10, ECOMAX-602-11, ECOMAX-602S-11, ECOMAX-612-10, ECOMAX-612S-10, FP, FX... (Other models you can see in the webshop)		



			
1			
Part No.	530821	Ref. No.	00-774080-001 774080-1
description	silicone hose ID ø 10mm ED ø 15mm L 1m thickness 2.5mm operating pressure without pressure burst pressure non defined t.max. 200°C transparent Shore 60°		
For models:	AM-10, AM-11, AM-141, AM-700, AM900, AM900-10N, AM900-90, AMS900, AMS900-10N, AMX, AMX-10HL, AMX-90, AMX-900, AMXR, AMXR-900, AMXS, AMXS-900, AMXT, AMXTS, AMXX, AMXX-1300, AMXXR, AMXXR-1300, AMXXS, AMXXS-1300, AMXXT, AUP, AUP-90, AUPS, AUXX, AUXX-1300, AUXXL, AUXXL-11N, AUXXLS-11N, AUXXR, AUXXR-1300, AUXXS, AUXXS-1300, AUXXT, AUXXTS, ECOMAX-402, ECOMAX-502, ECOMAX-600, ECOMAX-602-10, ECOMAX-602-11, ECOMAX-602S-11, ECOMAX-612-10, ECOMAX-612S-10, FP, FX... (Other models you can see in the webshop)		

softener cartridges

complete

			
1			
Part No.	530327	Ref. No.	00-775918-001 00-775918-010 775918-1
description	softener		
For models:	ECOMAX-402, ECOMAX-502, ECOMAX-602S-11, ECOMAX-612S-10		
accessories for	530327		
	Part No.	530174	Ref. No.
			00-775918-050 775918-150 775918-50
	lid kit for softener		

housing and bezels

miscellaneous

			
1			
Part No.	513070	Ref. No.	00-886756-004 886756-4
description	duct ID ø 14mm ED ø 19mm		
For models:	AM-10, AM-11, AM-141, AM-700, AM900, AM900-10N, AM900-90, AMS900, AMS900-10N, AMX, AMX-10HL, AMX-90, AMX-900, AMXR, AMXR-900, AMXS, AMXS-900, AMXT, AMXTS, AMXX, AMXX-1300, AMXXR, AMXXR-1300, AMXXS, AMXXS-1300, AMXXT, AUP, AUP-90, AUPS, AUXX, AUXX-1300, AUXXL, AUXXL-11N, AUXXLS-11N, AUXXR, AUXXR-1300, AUXXS, AUXXS-1300, AUXXT, AUXXTS, ECOMAX-402, ECOMAX-502, ECOMAX-602-10, ECOMAX-602-11, ECOMAX-602S-11, ECOMAX-612-10, ECOMAX-612S-10, ECOMAX-650, ECOMAX-700, FP... (Other models you can see in the webshop)		

			
1			
Part No.	513049	Ref. No.	00-886756-003 886756-3
description	duct ID ø 29mm ED ø 38mm		
For models:	AM-10, AM-11, AM-141, AM-700, AM900-10N, AM900-90, AMS900-10N, AMX, AMX-10HL, AMX-90, AMXR, AMXS, AMXT, AMXTS, AMXX, AMXXR, AMXXS, AUP, AUP-90, AUPS, AUXX, AUXXL-11N, AUXXLS-11N, AUXXR, AUXXS, AUXXT, AUXXTS, ECOMAX-402, ECOMAX-502, ECOMAX-600, ECOMAX-602-10, ECOMAX-602-11, ECOMAX-602S-11, ECOMAX-612-10, ECOMAX-612S-10, ECOMAX-700, GC, GC11, GC12, GC31, GC32, GC41, GC42, UX, UXL, UXLS, UXS, UXT, UXTH, UXTHL... (Other models you can see in the webshop)		

			
1			
Part No.	513048	Ref. No.	00-886756-001 886756-1
description	duct ID ø 41mm ED ø 50mm		
For models:	AM-10, AM-11, AM-141, AM-700, AM900, AM900-10N, AM900-90, AMS900, AMS900-10N, AMX, AMX-10HL, AMX-90, AMX-900, AMX-E, AMX-R, AMXR, AMX-R, AMXR-900, AMXS, AMXS-900, AMXT, AMXTS, AMXX, AMXX-1300, AMXXR, AMXXR-1300, AMXXS, AMXXS-1300, AMXXT, AUP, AUP-90, AUPS, AUX, AUX-E, AUX-ER, AUX-R, AUXX, AUXX-1300, AUXXL, AUXXL-11N, AUXXLS-11N, AUXXR, AUXXR-1300, AUXXS, AUXXS-1300, AUXXT, AUXXTS, CN-Protronic, CN-Smartronic, CS-Easytronic... (Other models you can see in the webshop)		

			
1			
Part No.	513708	Ref. No.	139321-815
description	lid rubber ø 17mm mounting ø 17mm		

hood mechanics for dishwashers

bolts

			
1			
Part No.	502220	Ref. No.	00-883965-001 883965-1
description	screw bolt ED ø 10mm L 22mm thread M5 kit for roller		
For models:	AM-10, AM-11, AM-141, AM900-10N, AM900-90, AMS900-10N, AMX, AMX-10HL, AMX-90, AMXR, AMXS, AMXT, AMXTS, AMXX, AMXXR, AMXXS, AUP, AUP-90, AUPS, AUXX, AUXXL-11N, AUXXLS-11N, AUXXR, AUXXS, AUXXT, AUXXTS, ECOMAX-602-10, ECOMAX-602-11, ECOMAX-602S-11, ECOMAX-612-10, ECOMAX-612S-10		



spring holders

			
1			
Part No.	517405	Ref. No.	00-883683-002 883683-2
description	spring holder for hood spring		
For models:	AM-10, AM-11, AM-141, AM900-10N, AM900-90, AMS900-10N, AMX, AMX-10HL, AMX-90, AMXR, AMXS, AMXX, AMXXR, AMXXS, AUP, AUP-90, AUPS, AUX, AUXR, AUXS, ECOMAX-602-10, ECOMAX-602-11, ECOMAX-602S-11, ECOMAX-612-10, ECOMAX-612S-10		

springs

			
1			
Part No.	511965	Ref. No.	119079-2
description	spring for hood mechanics wire gauge \varnothing 5.5mm \varnothing 50mm total length 385mm		
For models:	AM-12EC, AM-600C, AM-600CR, AMX, AMX-E, AMX-ER, AMX-R, AUX, AUX-, AUX-E, AUX-ER, AUX-R, FM-30, FM-400H, FM-500H, HE, HE600-HL, HE-P, HX, HX-30, HX-30E, HX-30ES, HX-30S, HX-40, HX-40E, HX-40ES, HX-40S, HX-60-EHL, HX-E, HX-ES, HX-S, UX-30EH, UX-30ESH, UX-30H, UX-30-McDonalds, UX-30SH		

			
1			
Part No.	517448	Ref. No.	139321-666
description	tension spring \varnothing 30mm total length 505mm wire gauge \varnothing 5.5mm for hood mechanics Qty 1 pcs		

guide bars

			
1			
Part No.	511681	Ref. No.	00-883477-001 01-297717-1 883477-1
description	guide L 480mm mounting pos. lower for hood		
For models:	AM-10, AM-11, AM-141, AM900-10N, AM900-90, AMS900-10N, AMX, AMX-10HL, AMX-90, AMXR, AMXS, AMXX, AMXXR, AMXXS, AUP, AUP-90, AUPS, AUX, AUXL-11N, AUXLS-11N, AUXXR, AUXXS, ECOMAX-602-10, ECOMAX-602-11, ECOMAX-602S-11, ECOMAX-612-10, ECOMAX-612S-10		

			
1			
Part No.	502223	Ref. No.	01-246900-001 01-246900-1
description	spacer for hood L 79mm W 24mm H 10mm		
For models:	AM-10, AM-11, AM-141, AM900-10N, AM900-90, AMS900-10N, AMX, AMX-10HL, AMX-90, AMXR, AMXS, AMXT, AMXTS, AMXX, AMXXR, AMXXS, AUP, AUP-90, AUPS, AUX, AUXL-11N, AUXLS-11N, AUXXR, AUXXS, AUP, AUP-90, AUPS, AUX, AUXL-1300, AUXL-11N, AUXLS-11N, AUXXR, AUXXR-1300, AUXXS, AUXXS-1300, AUXXT, AUXXTS, ECOMAX-602-10, ECOMAX-602-11, ECOMAX-602S-11, ECOMAX-612-10, ECOMAX-612S-10		

			
1			
Part No.	502224	Ref. No.	00-886987-001 886987-1
description	spacer kit for hood L 79mm W 24mm H 10mm		
For models:	AM-10, AM-11, AM-141, AM900-10N, AM900-90, AMS900-10N, AMX, AMX-10HL, AMX-90, AMXR, AMXS, AMXT, AMXTS, AMXX, AMXXR, AMXXS, AUP, AUP-90, AUPS, AUX, AUXL-1300, AUXL-11N, AUXLS-11N, AUXXR, AUXXR-1300, AUXXS, AUXXS-1300, AUXXT, AUXXTS, ECOMAX-602-10, ECOMAX-602-11, ECOMAX-602S-11, ECOMAX-612-10, ECOMAX-612S-10		

hood handles

			
1			
Part No.	513719	Ref. No.	139321-675
description	hood handle		

hood handle supports

			
1			
Part No.	502222	Ref. No.	00-898024-001 898024-1
description	bearing for hood handle plastic L 47mm W 38mm H 20mm		
For models:	AM-10, AM-11, AM-141, AM900-10N, AM900-90, AMS900-10N, AMX, AMX-10HL, AMX-90, AMXR, AMXS, AMXT, AMXTS, AMXX, AMXXR, AMXXS, AUP, AUP-90, AUPS, AUX, AUXL-11N, AUXLS-11N, AUXXR, AUXXS, AUXXT, AUXXTS, ECOMAX-602-10, ECOMAX-602-11, ECOMAX-602S-11, ECOMAX-612-10, ECOMAX-612S-10		

mechanical components,
equipment accessories

1



rollers



Part No.	502221	Ref. No.	00-898080-001 898080-1
description	roller ø 29mm for hood mechanics kit hole ø 10mm		
For models:	AM-10, AM-11, AM-141, AM-700, AM900, AM900-10N, AM900-90, AMS900, AMS900-10N, AMX, AMX-10HL, AMX-90, AMX-900, AMX-E, AMX-ER, AMXR, AMX-R, AMXR-900, AMXS, AMXS-900, AMXT, AMXTS, AMXX, AMXX-1300, AMXXR, AMXXR-1300, AMXXS, AMXXS-1300, AMXXT, AUP, AUP-90, AUPS, AUX, AUX-E, AUX-ER, AUX-R, AUX, AUX-1300, AUXXL, AUXXL-11N, AUXXLS-11N, AUXXR, AUXXR-1300, AUXXS, AUXXS-1300, AUXXT, AUXXTS, ECOMAX-600, ECOMAX-602-10, ECOMAX-602-11...(Other models you can see in the webshop)		
accessories for	502221		
	Part No.	502220	Ref. No. 00-883965-001 883965-1
screw bolt ED ø 10mm L 22mm thread M5 kit for roller			

miscellaneous



Part No.	508375	Ref. No.	139321-674
description	fixing support		





Part No.	502226	Ref. No.	00-228828-000
description	rubber pad ED ø 9mm black		
For models:	AM-10, AM-11, AM-141, AM-700, AM900, AM900-10N, AM900-90, AMS900, AMS900-10N, AMX, AMX-10HL, AMX-90, AMX-900, AMX-E, AMX-ER, AMXR, AMX-R, AMXR-900, AMXS, AMXS-900, AMXT, AMXTS, AMXX, AMXX-1300, AMXXR, AMXXR-1300, AMXXS, AMXXS-1300, AMXXT, AUP, AUP-90, AUPS, AUX, AUX_, AUX-E, AUX-ER, AUX-R, AUX, AUX-1300, AUXXL, AUXXL-11N, AUXXLS-11N, AUXXR, AUXXR-1300, AUXXS, AUXXS-1300, AUXXT, AUXXTS, ECOMAX-600, ECOMAX-602-10...(Other models you can see in the webshop)		



air traps

air traps



Part No.	518488	Ref. No.	139321-724
description	air trap		
accessories for	518488		
	Part No.	504618	Ref. No. —
O-ring EPDM thickness 2.62mm ID ø 15.54mm Qty 1 pcs			

accessories for	518488		
	Part No.	510075	Ref. No. 139321-725
flat gasket rubber ED ø 22mm ID ø 13mm thickness 1.5mm Qty 1 pcs			
	Part No.	510106	Ref. No. 139321-722
hose connector for air trap			

	Part No.	503162	Ref. No. 01-240372-001 01-240372-1
description	air trap complete L 77mm W 83mm connection ø 24mm hose ø 6mm		
For models:	AM-10, AM-11, AM-141, AM900-10N, AM900-90, AMS900-10N, AMX, AMX-10HL, AMX-90, AMXR, AMXS, AMXT, AMXTS, AMXX, AMXXR, AMXXS, AUP, AUP-90, AUPS, AUX, AUXXL-11N, AUXXLS-11N, AUXXR, AUXXS, AUXXT, AUXXTS, ECOMAX-402, ECOMAX-502, ECOMAX-602-10, ECOMAX-602-11, ECOMAX-602S-11, ECOMAX-612-10, ECOMAX-612S-10, FP, FX, FX-McDonalds, GP, GX		
accessories for	503162		
	Part No.	520027	Ref. No. 00-324402-005 00-324402-014 139321-126 324402-14 324402-5
PVC hose ID ø 4mm ED ø 7mm L 10m thickness 1.5mm t.max. 60°C transparent			

	Part No.	517575	Ref. No. 324858
description	air trap L 78mm W 40mm H 66mm hose ø 5mm plastic		
For models:	AM3, AMX, AMX-E, AMX-ER, AMX-R, AUX, AUX_, AUX-E, AUX-ER, AUX-R, FE, HE, HE600-HL, HE-P, UXD-30		





	Part No.	510103	Ref. No. 139321-47
description	air trap L 85mm W 20mm H 80mm hose ø 6mm plastic		
For models:	AM-700, AM900, AMS900, AMX-900, AMXR-900, AMXS-900, AMXX-1300, AMXXR-1300, AMXXS-1300, AMXXT, AUX-1300, AUXXL, AUXXR-1300, AUXXS-1300, AUXXT, ECOMAX-600, ECOMAX-650, ECOMAX-700, FE-W, FX, GC, GC11, GC12, GC31, GC32, GC41, GC42, GE-400, GW-600, GW-600S, GW-601, GW-601S, GX, HX, HX-30, HX-30E, HX-30ES, HX-30S, HX-40, HX-40E, HX-40ES, HX-40S, HX-60-EHL, HX-E, HX-ES, HX-S, UX, UX-30, UX-30B, UX-30E...(Other models you can see in the webshop)		
spare parts for	510103		
	Part No.	505045	Ref. No. —
O-ring EPDM thickness 1.78mm ID ø 5.28mm Qty 1 pcs			
	Part No.	505094	Ref. No. —
air trap			
	Part No.	510016	Ref. No. 139321-180 897923
eye bolt for rinse aid container connection			

Table continues overleaf



spare parts for 510103			
	Part No.	510105	Ref. No. 139321-202 897923
hose connector for air trap			



Part No.	510111	Ref. No.	139321-550
description	air trap ø 34mm H 130mm hose ø 6mm plastic		
For models:	CHH-50, CHH-60D, CHH-70D, CLG-25, EH-60, EH-70		

spare parts for 510111			
	Part No.	504618	Ref. No. —
O-ring EPDM thickness 2.62mm ID ø 15.54mm Qty 1 pcs			

	Part No.	510075	Ref. No. 139321-725
flat gasket rubber ED ø 22mm ID ø 13mm thickness 1.5mm Qty 1 pcs			

	Part No.	510106	Ref. No. 139321-722
hose connector for air trap			



Part No.	511993	Ref. No.	107013
description	air trap ø 43mm H 33mm hose ø 6mm plastic		
For models:	H-60		

air trap accessories

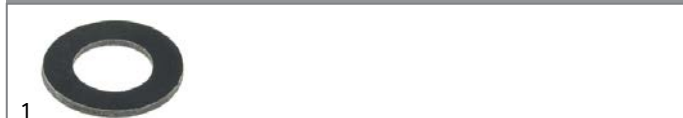

Part No.	510075	Ref. No.	139321-725
description	flat gasket rubber ED ø 22mm ID ø 13mm thickness 1.5mm Qty 1 pcs		



Part No.	510105	Ref. No.	139321-202 897923
description	hose connector for air trap		

For models: AM-700, AM900, AMS900, AMX, AMX-900, AMX-E, AMX-ER, AMX-R, AMXR-900, AMXS-900, AMXX-1300, AMXXR-1300, AMXXS-1300, AMXXT, AUX, AUX_, AUX-E, AUX-ER, AUX-R, AUX-1300, AUXXL, AUXXR-1300, AUXXS-1300, AUXXT, ECOMAX-600, ECOMAX-650, FE, FE-W, FX, GE-400, GW-600, GW-600S, GW-601, GW-601S, GX, HE, HE600-HL, HE-P, HX, HX-30, HX-30E, HX-30ES, HX-30S, HX-40, HX-40E, HX-40ES, HX-40S, HX-60-EHL, HX-E, HX-ES...(Other models you can see in the webshop)

spare parts for 510105			
	Part No.	510017	Ref. No. —
union screw			



Part No.	510106	Ref. No.	139321-722
description	hose connector for air trap		

mechanics for flight type dishwashers



Part No.	524525	Ref. No.	229326-1
description	bar for transport system L 600mm ø 7mm suitable for HOBART		
For models:	FTX		



Part No.	524884	Ref. No.	00-154791-000
description	gasket H 35mm ø 66mm ID ø 16mm		
For models:	CN, CNA, CNB, CN-Protronic, CNR, CN-Smartronic, CP-Protronic, CR, CR-F, CSA, CS-Easytronic, ECOMAX-800		



Part No.	524526	Ref. No.	229319
description	roller for transport system L 24.4mm ID ø 7.4mm ED ø 20/25mm suitable for HOBART		
For models:	FTX		



Part No.	524527	Ref. No.	774643-1
description	roller for transport system L 26.2mm ID ø 7.2mm ED ø 20/26mm suitable for HOBART		



Part No.	524879	Ref. No.	302 207-22
description	sliding rail for door L 380mm		
For models:	UX, UXS, UXT, UXTS		



Part No.	524683	Ref. No.	112378-21 302207-4
description	sliding rail for door L 870mm W 8mm H 11.5mm suitable for HOBART		
For models:	CX, FTX, FUX		





			
1			
Part No.	524878	Ref. No.	229 102
description	tappet W 70mm H 87mm hole distance 58.5mm		
For models:	FTX		

pipes



			
1			
Part No.	513047	Ref. No.	00-883512-001 883512-1
description	pipe 14x2.0mm tube ø 14mm L 933mm PE-Xb		
For models:	AM-10, AM-11, AM-141, AM900-10N, AM900-90, AMS900-10N, AMX, AMX-10HL, AMX-90, AMXR, AMXS, AMXT, AMXTS, AMXX, AMXXR, AMXXS, AUP, AUP-90, AUPS, AUXX, AUXXR, AUXXS, AUXXT, AUXXTS, ECOMAX-602-10, ECOMAX-602-11, ECOMAX-602S-11, ECOMAX-612-10, ECOMAX-612S-10		

backflow preventers

backflow preventers

				
1				
Part No.	511672	Ref. No.	00-775759-001 775759-1	
description	backflow preventer			
For models:	AM-10, AM-11, AM-141, AM-700, AM900-90, AMX-90, AUP-90, CNA, CNB, CNR, CSA, ECOMAX-402, ECOMAX-502, ECOMAX-600, ECOMAX-602-10, ECOMAX-650, ECOMAX-700, ECOMAX-800, FP, FX, FX-McDonalds, GC, GC11, GC12			
accessories for	511672			
	Part No.	502228	Ref. No.	00-324384-000 324384
	nut for back flow restrictor ø 35mm WS 30			
	Part No.	507495	Ref. No.	00-775305-001 172513 775305-1
	gasket ED ø 34mm ID ø 25.5mm thickness 2.5mm Qty 1 pcs			

				
1				
Part No.	511673	Ref. No.	00-883817-001 883817-1	
description	backflow preventer			
For models:	AM900-10N, AM900-90, AMS900-10N, AMX, AMX-10HL, AMX-90, AMXR, AMXS, AMXT, AMXTS, AMXX, AMXXR, AMXXS, AUP, AUP-90, AUPS, AUXX, AUXXL-11N, AUXXLS-11N, AUXXR, AUXXS, AUXXT, AUXXTS, ECOMAX-602-11, ECOMAX-602S-11, ECOMAX-612-10, ECOMAX-612S-10			
spare parts for	511673			
	Part No.	511680	Ref. No.	00-324313-002 324313-2
	ball for back flow restrictor ø 8mm			
accessories for	511673			
	Part No.	511675	Ref. No.	00-775531-001 775531-1
	blind plug for back flow restrictor ø 10mm L 26mm rubber			

				
1				
Part No.	511674	Ref. No.	01-240142-001 01-240142-1	
description	backflow preventer			
For models:	ECOMAX-402, ECOMAX-502, FP, FX, FX-McDonalds, GP, GX			
spare parts for	511674			
	Part No.	511680	Ref. No.	00-324313-002 324313-2
	ball for back flow restrictor ø 8mm			
accessories for	511674			
	Part No.	511675	Ref. No.	00-775531-001 775531-1
	blind plug for back flow restrictor ø 10mm L 26mm rubber			

			
1			
Part No.	524882	Ref. No.	324091
description	backflow preventer hose ø 12mm		
For models:	ACW, CR-F, FE, FTN, FTT, FTX, FUX, FX, GX, HE, HE600-HL, HX-30ES, HX-30S, HX-40ES, HX-40S, HX-ES, HX-S, UW-135, UW-135H, UX-30ES, UX-30ESB, UX-30ESH, UX-30-McDonalds, UX-30S, UX-30SB, UX-30SH		

1

Part No.	524513	Ref. No.	324158 886641
description	backflow preventer hose ø 13/18mm		
For models:	AM3, AMX, AMX-E, AMX-ER, AMX-R, AUX, AUX_, AUX-E, AUX-ER, AUX-R, FX, UX-30, UX-30B, UX-30E, UX-30EB, UX-30EH, UX-30H, UX-30-McDonalds, UX-60, UX-60B, UX-60E, UX-60EB, UX-60EH, UX-60EHB, UX-60H, UX-60HB, UXD-30		



1

Part No.	524457	Ref. No.	00-775540-001 00-775540-011 01-297510-001 01-297510-002 01-297510-2 01-297695-001 01-297695-1 775540-1 775540-11
description	backflow preventer kit		
For models:	AM900, AM900-10N, AM900-90, AMS900, AMS900-10N, AMX, AMX-10HL, AMX-90, AMX-900, AMX-E, AMX-ER, AMXR, AMX-R, AMXR-900, AMXS, AMXS-900, AMXT, AMXTS, AMXX, AMXX-1300, AMXXR, AMXXR-1300, AMXXS, AMXXS-1300, AMXXT, AUP, AUP-90, AUPS, AUX, AUX-E, AUX-ER, AUX-R, AUXX, AUXX-1300, AUXXL, AUXXL-11N, AUXXLS-11N, AUXXR, AUXXR-1300, AUXXS, AUXXS-1300, AUXXT, AUXXTS, ECOMAX-402, ECOMAX-502, ECOMAX-602-11, ECOMAX-602S-11, ECOMAX-612-10, ECOMAX-612S-10, ECOMAX-650... (Other models you can see in the webshop)		
spare parts for	524457		



Part No.	502228	Ref. No.	00-324384-000 324384
description	nut for back flow restrictor ø 35mm WS 30		



Part No.	520015	Ref. No.	00-775559-007 00-775559-008 00-775559-013 00-775559-016 139321-125 139321-611 775559-13 775559-16 775559-7 775559-8
description	supply hose ID ø 10mm ED ø 17mm L 5m operating p. 20bar burst p. 60bar t.max. 95°C grey Qty 5m		



Part No.	511675	Ref. No.	00-775531-001 775531-1
description	blind plug for back flow restrictor ø 10mm L 26mm rubber		



Part No.	511680	Ref. No.	00-324313-002 324313-2
description	ball for back flow restrictor ø 8mm		
For models:	AMX, AMX-E, AMX-ER, AMX-R, AUX, AUX_, AUX-E, AUX-ER, AUX-R, CR, ECOMAX-402, ECOMAX-502, UX-30, UX-30B, UX-30E, UX-30EB, UX-60, UX-60B, UX-60E, UX-60EB		



1

Part No.	523077	Ref. No.	01-297695-2
description	backflow preventer kit with cover cap		

non-return valves



1

Part No.	517573	Ref. No.	146669-1 292909
description	non-return valve thread 1/2" IT		
For models:	AM-600, AM-600C, AM-600CR, AM-600R, CX, FM-400H, FM-500H, UW-105, UWX		

accessories



1

Part No.	511680	Ref. No.	00-324313-002 324313-2
description	ball for back flow restrictor ø 8mm		
For models:	AMX, AMX-E, AMX-ER, AMX-R, AUX, AUX_, AUX-E, AUX-ER, AUX-R, CR, ECOMAX-402, ECOMAX-502, UX-30, UX-30B, UX-30E, UX-30EB, UX-60, UX-60B, UX-60E, UX-60EB		



1

Part No.	511675	Ref. No.	00-775531-001 775531-1
description	blind plug for back flow restrictor ø 10mm L 26mm rubber		
For models:	AM900, AM900-10N, AM900-90, AMS900, AMS900-10N, AMX, AMX-10HL, AMX-90, AMX-900, AMX-E, AMX-ER, AMXR, AMX-R, AMXR-900, AMXS, AMXS-900, AMXT, AMXTS, AMXX, AMXX-1300, AMXXR, AMXXR-1300, AMXXS, AMXXS-1300, AMXXT, AUP, AUP-90, AUPS, AUX, AUX-E, AUX-ER, AUX-R, AUXX, AUXX-1300, AUXXL, AUXXL-11N, AUXXLS-11N, AUXXR, AUXXR-1300, AUXXS, AUXXS-1300, AUXXT, AUXXTS, ECOMAX-402, ECOMAX-502, ECOMAX-602-11, ECOMAX-612-10, ECOMAX-650, FP, FX...(Other models you can see in the webshop)		

1 mechanical components, equipment accessories



1

Part No.	502228	Ref. No.	00-324384-000
description	nut for back flow restrictor ø 35mm WS 30		
For models:	AM-10, AM-11, AM-141, AM-600, AM-600C, AM-600CR, AM-600R, AM-700, AM900, AM900-10N, AM900-90, AMS900, AMS900-10N, AMX, AMX-10HL, AMX-90, AMX-900, AMX-E, AMX-ER, AMXR, AMX-R, AMXR-900, AMXS, AMXS-900, AMXT, AMXTS, AMXX, AMXX-1300, AMXXR, AMXXR-1300, AMXXS, AMXXS-1300, AMXXT, AUP, AUP-90, AUPS, AUX, AUX_, AUX-E, AUX-ER, AUX-R, AUXX, AUXX-1300, AUXXL, AUXXL-11N, AUXXLS-11N, AUXXR, AUXXR-1300, AUXXS, AUXXS-1300...(Other models you can see in the webshop)		

miscellaneous



1

Part No.	530469	Ref. No.	325308-1
description	plug for washing arms rubber L 24mm D1 ø 34mm mounting ø 20mm ID ø 15mm		
For models:	CNR, CR, ECW		



1

Part No.	518129	Ref. No.	136763
description	shaft bearing brass H 32mm D1 ø 38mm D2 ø 32mm ID ø 25.4mm		



1

Part No.	511676	Ref. No.	00-324097-000 00-883281-001 883281-1
description	water inlet for tank plastic D1 ø 18mm for HOBART		
For models:	AM-600, AM-600C, AM-600CR, AM-600R, AM900, AM900-10N, AM900-90, AMS900, AMS900-10N, AMX, AMX-10HL, AMX-90, AMX-900, AMX-E, AMX-ER, AMXR, AMX-R, AMXR-900, AMXS, AMXS-900, AMXT, AMXTS, AMXX, AMXX-1300, AMXXR, AMXXR-1300, AMXXS, AMXXS-1300, AMXXT, AUP, AUP-90, AUPS, AUX, AUX-E, AUX-ER, AUX-R, AUXX, AUXX-1300, AUXXL, AUXXL-11N, AUXXLS-11N, AUXXR, AUXXR-1300, AUXXS, AUXXS-1300, AUXXT, AUXXTS, ECOMAX-602-11, ECOMAX-602S-11, ECOMAX-612-10...(Other models you can see in the webshop)		

door mechanics

bolts



1

Part No.	502219	Ref. No.	01-240151-001 01-240151-1
description	door bolt ø 8mm L 15mm thread M5 stainless steel		
For models:	ECOMAX-402, ECOMAX-502, FP, FX, FX-McDonalds, GP, GX		

springs

roller springs



1

Part No.	519514	Ref. No.	774749-5
description	roller spring complete W 40mm ID ø 10.5mm lug length 49mm		
For models:	CN, CNA, CNB, CNR, CR, FTN		



1

Part No.	519492	Ref. No.	774749-2
description	roller spring complete W 40mm ID ø 10.5mm lug length 54mm		
For models:	CN, CNA, CNB, CNR, CR, CR-F, FTN		



1

Part No.	519496	Ref. No.	774749-6
description	roller spring W 40mm ID ø 10.5mm lug length 52mm		
For models:	CN, CNA, CNB, CNR, CR, FTN		



1

Part No.	517409	Ref. No.	774749-3
description	roller spring W 40mm ID ø 10.5mm lug length 54mm		
For models:	CSA, FTN		



1

Part No.	519515	Ref. No.	229277
description	roller spring W 40mm ID ø 35mm lug length 23mm		
For models:	CX, FTT, FTX, FUX		



1

Part No.	520590	Ref. No.	01-245278-7
description	roller spring W 55mm ID ø 11mm lug length 30mm		



1

Part No.	694272	Ref. No.	299110 378591
description	roller spring W 65mm ID ø 48mm lug length 24mm		
For models:	UW-100, UW-105, UW-120, UW-125, UW-200, UW-205		

tension springs



1

Part No.	504424	Ref. No.	00-324773-000
description	tension spring ø 20mm total length 245mm wire gauge ø 2.5mm for door Qty 1 pcs		
For models:	UX-30, UX-30E, UX-30ES, UX-30-McDonalds, UX-30S, UX-60, UX-60E, UXD-30, UXL, UXLS		

linkage



1

Part No.	518362	Ref. No.	139321-568
description	door pin door pin		
For models:	CHF45, EF-40		



1

Part No.	518355	Ref. No.	139321-824
description	door pin stop rod		

sliding plates



1

Part No.	518356	Ref. No.	139321-823
description	sliding plate sliding plate		



1

Part No.	518353	Ref. No.	E307005
description	stop plastic for door L 60mm W 12.5mm H 10mm		



hinges



1

Part No.	503501	Ref. No.	324002-2
description	door hinge hinge left mounting pos. left		
For models:	FX, GX		



1

Part No.	518547	Ref. No.	139321-267
description	door hinge hinge mounting pos. left		
For models:	GE-400, GW-600, GW-600S, GW-601, GW-601S		



1

Part No.	503500	Ref. No.	324002-1
description	door hinge hinge right mounting pos. right		
For models:	FX, GX		



1

Part No.	518301	Ref. No.	139321-825
description	door hinge mounting pos. left/right		



1

Part No.	518122	Ref. No.	139321-560
description	hinge complete for dishwasher L 588mm		

hinge camps



1

Part No.	502225	Ref. No.	01-294108-001 01-294108-1
-----------------	--------	-----------------	------------------------------

description hinge block plastic T1: M5**For models:** ECOMAX-402, ECOMAX-502**accessories for** 502225

Part No.	502219	Ref. No.	01-240151-001 01-240151-1
-----------------	--------	-----------------	------------------------------

door bolt ø 8mm L 15mm thread M5 stainless steel

hinge pins



1

Part No.	518267	Ref. No.	139321-826
-----------------	--------	-----------------	------------

description hinge pin hinge pin

door guides



1

Part No.	698702	Ref. No.	325064-4
-----------------	--------	-----------------	----------

description sliding rail L 812mm W 31mm**For models:** CN, CNA, CNB, CNR, CR

door bumpers

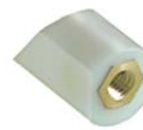

1

Part No.	518066	Ref. No.	139321-822
-----------------	--------	-----------------	------------

description door bumper end stop

1

Part No.	505295	Ref. No.	01-240741-001 01-240741-1
-----------------	--------	-----------------	------------------------------

description door bumper H 7.5mm L 17mm W 10mm**For models:** ECOMAX-402, ECOMAX-502



door shafts



1

Part No.	524883	Ref. No.	774495-1
description	shaft ø 10mm L 76mm for dishwasher door		
For models:	CN, CNA, CNB, CNR, CR, CR-F, CSA, ECOMAX-800, FTN		

locks



1

Part No.	512287	Ref. No.	01-240763-001 01-510284-1
description	door catch L 51mm W 35mm H 13mm		
For models:	ECOMAX-402, ECOMAX-502		



1

Part No.	513138	Ref. No.	139321-817
description	door catch with nut door locking catch		



1

Part No.	701126	Ref. No.	324221
description	snap lock L 33mm with roller thread M12x1.75 for dishwasher		
For models:	ECOMAX-700, FE, FX, GX, UX-30, UX-30E, UX-30ES, UX-30-McDonalds, UX-30S, UX-60, UX-60E		



1

Part No.	518245	Ref. No.	139321-821
description	spigot door catch		



1

Part No.	518298	Ref. No.	139321-1116
description	spigot door catch		

miscellaneous



1

Part No.	503502	Ref. No.	228693-1
description	bush		
For models:	FE-W, FM-30U, FM-400U, FM-500, FX, GX, HX, HX-30, HX-30E, HX-30ES, HX-30S, HX-40, HX-40E, HX-40ES, HX-40S, HX-60-EHL, HX-E, HX-ES, HX-S, UW-55		



1

Part No.	698634	Ref. No.	324322
description	deflector H 30mm L 125mm W 30mm		
For models:	AMX, AMX-E, AMX-ER, AMX-R, AUX, AUX_, AUX-E, AUX-ER, AUX-R, HE, HE-P, HX, HX-30, HX-30E, HX-30ES, HX-30S, HX-40, HX-40E, HX-40ES, HX-40S, HX-E, HX-ES, HX-S		



1

Part No.	524458	Ref. No.	324194 886253-1
description	foam rubber gasket for door L 560mm W 19mm thickness 4mm		
For models:	FX, GX		



1

Part No.	524926	Ref. No.	323930-1
description	gasket for bearing ID ø 12mm H 23mm L 30mm W 12mm mounting pos. left		
For models:	FE, FE-W		



1

Part No.	524925	Ref. No.	323930-2
description	gasket for bearing ID ø 12mm H 23mm L 30mm W 12mm mounting pos. right		
For models:	FE, FE-W		



1



Part No.	519524	Ref. No.	00-226640-000
description	handle for door mechanism PVC ϕ 23mm L 122mm		
For models:	AM-10, AM-11, AM-12E, AM-12EC, AM-12ER, AM-141, AM-600, AM-600C, AM-600CR, AM-600R, AMX, AMX-E, AMX-ER, AMX-R, AUX, AUX-E, AUX-ER, AUX-R, ECOMAX-602-10, ECOMAX-602-11, ECOMAX-602S-11, ECOMAX-612-10, ECOMAX-612S-10, FM-400H, FM-500H, HE, HE600-HL, HE-P, HX, HX-60-EHL, HX-E, HX-ES, HX-S, UX-30EH, UX-30ESH, UX-30H, UX-30-McDonalds, UX-30SH		

1



Part No.	504376	Ref. No.	01-240176-001 01-240176-1
description	slide bearing plastic ED ϕ 15mm ID ϕ 8mm D2 ϕ 10mm		
For models:	ECOMAX-402, ECOMAX-502, FP, FX, FX-McDonalds, GP, GX		

1



Part No.	502227	Ref. No.	00-883931-001 883931-1
description	spanner for tension spring ϕ 10mm L 285mm thread M10x1.5		
For models:	AM-10, AM-11, AM-141, AM900-10N, AM900-90, AMS900-10N, AMX, AMX-10HL, AMX-90, AMXR, AMXS, AMXT, AMXTS, AMXX, AMXXR, AMXXS, AUP, AUP-90, AUPS, AUXX, AUXXL-11N, AUXXLS-11N, AUXXR, AUXXS, AUXXT, AUXXTS, ECOMAX-602-10, ECOMAX-602-11, ECOMAX-602S-11, ECOMAX-612-10, ECOMAX-612S-10		

1



Part No.	502218	Ref. No.	00-883947-001 883947-1
description	spare parts kit for door mechanism door link with door lift handle		
For models:	AM-10, AM-11, AM-141, AM900-10N, AM900-90, AMS900-10N, AMX, AMX-10HL, AMX-90, AMXR, AMXS, AMXT, AMXTS, AMXX, AMXXR, AMXXS, AUP, AUP-90, AUPS, AUXX, AUXXR, AUXXS, AUXXT, AUXXTS, ECOMAX-602-10, ECOMAX-602-11, ECOMAX-602S-11, ECOMAX-612-10, ECOMAX-612S-10		

1



Part No.	519523	Ref. No.	01-240764-001 01-240764-1
description	spring for door latch L 45mm W 25mm		
For models:	ECOMAX-402, ECOMAX-502		

screw connections

1



Part No.	505288	Ref. No.	00-695664-004 695664-4
description	nut thread M25x1.5 H 6mm WS 30 Qty 1 pcs for cable gland		
For models:	CN-Protronic, CN-Smartronic, CP-Protronic, ECOMAX-402, ECOMAX-502		

curtains

curtains

1

Part No.	533133	Ref. No.	229436-5
description	curtain W 1095mm H 210mm warewashing		
For models:	FTX, FUX		

1



Part No.	533134	Ref. No.	229436-4
description	curtain W 1095mm H 400mm warewashing		
For models:	FTX, FUX		

1



Part No.	533135	Ref. No.	229436-6
description	curtain W 1095mm H 643mm warewashing		
For models:	FTX, FUX		

1



Part No.	533139	Ref. No.	230781
description	curtain W 625mm H 420mm warewashing		
For models:	CR-F, CX		



1

Part No.	533137	Ref. No.	231602-2
description	curtain W 640mm H 210mm warewashing		
For models:	CX		

1

Part No.	533130	Ref. No.	229436-2
description	curtain W 740mm H 210mm warewashing		
For models:	FTX		

1



1

Part No.	533138	Ref. No.	231602-1
description	curtain W 640mm H 380mm warewashing		
For models:	CX		

1



1

Part No.	533131	Ref. No.	229436-1
description	curtain W 740mm H 400mm warewashing		
For models:	FTX, FUX		

1

Part No.	533148	Ref. No.	781284-1
description	curtain W 645mm H 290mm warewashing		
For models:	CN, CNA, CNB, CNR, CR, CSA		

1

Part No.	533132	Ref. No.	229436-3
description	curtain W 740mm H 643mm warewashing		
For models:	FTX, FUX		

1

Part No.	533149	Ref. No.	781033-1
description	curtain W 645mm H 420mm warewashing		
For models:	CN, CNA, CNB, CNR, CR, CSA, ECOMAX-800		

1



1

Part No.	533140	Ref. No.	325346-4
description	curtain W 750mm H 365mm warewashing		
For models:	FTN		

1



1

Part No.	533150	Ref. No.	781067-1
description	curtain W 645mm H 430mm warewashing		
For models:	CN, CNA, CNB, CNR, CR, CSA, ECOMAX-800		

1



1

Part No.	533141	Ref. No.	325346-8
description	curtain W 750mm H 385mm warewashing		
For models:	FTN		



1

Part No.	533142	Ref. No.	325346-5
description	curtain W 750mm H 480mm warewashing		
For models:	FTN		

2

Part No.	533143	Ref. No.	325346-1
description	curtain W 750mm H 485mm warewashing		
For models:	FTN		

1

Part No.	533144	Ref. No.	325346-3
description	curtain W 942mm H 365mm warewashing		
For models:	FTN		

1

Part No.	533145	Ref. No.	00-325346-007 325346-7
description	curtain W 942mm H 385mm warewashing		
For models:	FTN		

1

Part No.	533146	Ref. No.	325346-6
description	curtain W 942mm H 480mm warewashing		
For models:	FTN		

1

Part No.	533147	Ref. No.	325346-2
description	curtain W 942mm H 485mm warewashing		
For models:	FTN		

curtain rods

1

Part No.	533152	Ref. No.	229924 229924-1
description	curtain rod L 1090mm ø 8mm		
For models:	FTX, FUX		

1

Part No.	533153	Ref. No.	231540-3
description	curtain rod L 606mm ø 8mm		
For models:	CX		

1

Part No.	533154	Ref. No.	231540-1
description	curtain rod L 612mm ø 8mm		
For models:	CX		

1

Part No.	533155	Ref. No.	137143
description	curtain rod L 620mm ø 8mm		



1

Part No.	533160	Ref. No.	325360-8
description	curtain rod L 645mm ø 8mm		
For models:	ECW		

1

Part No.	533158	Ref. No.	325360-3
description	curtain rod L 942mm ø 8mm		
For models:	FTN		

2



Part No.	533159	Ref. No.	231540-5 325360-7
description	curtain rod L 655mm ø 8mm		
For models:	CN, CNA, CNB, CNR, CR, CR-F, CSA, ECOMAX-800		

washing and rinsing systems

1



Part No.	518114	Ref. No.	228643 B228643
description	bush for rinse arm ø 14mm H 21mm		
For models:	AM-12E, AM-12EC, AM-12EF, AM-12ER, AM-600, AM-600C, AM-600CR, AM-600R, FM-30, FM-300U, FM-30U, FM-400H, FM-400U, FM-500, FM-500H, UW-100, UW-105, UW-120, UW-125, UW-135, UW-135H, UW-200, UW-205, UW-55		

1

Part No.	533156	Ref. No.	231540-2
description	curtain rod L 680mm ø 8mm		
For models:	CX		

1



Part No.	530468	Ref. No.	493414
description	bushing for rinse arm mounting pos. upper/lower ø 15mm ID ø 12mm H 16mm		
For models:	CNR, CR, CR-F		

1

Part No.	533151	Ref. No.	229214
description	curtain rod L 740mm ø 8mm		
For models:	FTX, FUX		

1



Part No.	510638	Ref. No.	324068
description	clamping ring ID ø 41mm ED ø 45mm thickness 3mm		
For models:	AM-700, AM900, AMS900, AMX-900, AMXR-900, AMXS-900, ECOMAX-600, ECOMAX-650, FE, FE-W, FX, GX, HE, HE600-HL, HE-P, HX, HX-30, HX-30E, HX-30ES, HX-30S, HX-40, HX-40E, HX-40ES, HX-40S, HX-60-EHL, HX-E, HX-ES, HX-S		

1

Part No.	533157	Ref. No.	325360-2
description	curtain rod L 750mm ø 8mm		
For models:	FTN		





			
1			
Part No.	694621	Ref. No.	324751
description	clamping ring ID \varnothing 58.5mm ED \varnothing 64mm thickness 3mm		
For models:	AMX, AMX-E, AMX-ER, AMX-R, AMXX-1300, AMXXR-1300, AMXXS-1300, AMXXT, AUX, AUX_, AUX-E, AUX-ER, AUX-R, AUXX-1300, AUXXL, AUXXR-1300, AUXXS-1300, AUXXT, ECOMAX-700, UX, UX-30, UX-30B, UX-30E, UX-30EB, UX-30EH, UX-30ES, UX-30ESB, UX-30ESH, UX-30H, UX-30-McDonalds, UX-30S, UX-30SB, UX-30SH, UX-60, UX-60B, UX-60E, UX-60EB, UX-60EH, UX-60EHB, UX-60H, UX-60HB, UXD-30, UXL, UXLS, UXS, UXT, UXTH, UXTHL, UXTHLS, UXTHS...(Other models you can see in the webshop)		

			
2			
Part No.	511966	Ref. No.	119229
description	compression spring \varnothing 23mm L 22mm wire gauge \varnothing 1.5mm		
For models:	AM-12E, AM-12EC, AM-12EF, AM-12ER, AM-600, AM-600C, AM-600CR, AM-600R, UW-100, UW-105, UW-120, UW-125, UW-135, UW-135H, UW-200, UW-205		

			
1			
Part No.	507497	Ref. No.	00-883481-001 883481-1
description	connection wash pipe \varnothing 47mm connection 66x36mm		
For models:	AM-10, AM-11, AM-141, AM900-10N, AM900-90, AMS900-10N, AMX, AMX-10HL, AMX-90, AMXR, AMXS, AMXT, AMXTS, AMXX, AMXXR, AMXXS, AUP, AUP-90, AUPS, AUXX, AUXXL-11N, AUXXLS-11N, AUXXR, AUXXS, AUXXT, AUXXTS, ECOMAX-602-10, ECOMAX-602-11, ECOMAX-602S-11, ECOMAX-612-10, ECOMAX-612S-10		

			
1			
Part No.	510016	Ref. No.	139321-180 897923
description	eye bolt for rinse aid container connection		
For models:	AM-700, AM900, AMS900, AMX, AMX-900, AMX-E, AMX-ER, AMX-R, AMXR-900, AMXS-900, AMXX-1300, AMXXR-1300, AMXXS-1300, AMXXT, AUX, AUX_, AUX-E, AUX-ER, AUX-R, AUXX-1300, AUXXL, AUXXR-1300, AUXXS-1300, AUXXT, ECOMAX-600, ECOMAX-650, FE, FE-W, FX, GE-400, GW-600, GW-600S, GW-601, GW-601S, GX, HE, HE600-HL, HE-P, HX, HX-30, HX-30E, HX-30ES, HX-30S, HX-40, HX-40E, HX-40ES, HX-40S, HX-60-EHL, HX-E, HX-ES...(Other models you can see in the webshop)		

			
1			
Part No.	518461	Ref. No.	139321-865
description	flange for wash arm support		

			
1			
Part No.	517403	Ref. No.	00-172986-035 172986-35
description	flat gasket EPDM ED \varnothing 71mm ID \varnothing 61mm thickness 1.5mm Qty 1 pcs		
For models:	AM-10, AM-11, AM-141, AM900-10N, AM900-90, AMS900-10N, AMX, AMX-10HL, AMX-90, AMXR, AMXS, AMXT, AMXTS, AMXX, AMXXR, AMXXS, AUP, AUP-90, AUPS, AUXX, AUXXL-11N, AUXXLS-11N, AUXXR, AUXXS, AUXXT, AUXXTS, ECOMAX-602-10, ECOMAX-602-11, ECOMAX-602S-11, ECOMAX-612-10, ECOMAX-612S-10		

			
1			
Part No.	518240	Ref. No.	139321-780
description	flat gasket rubber ED \varnothing 33mm ID \varnothing 17mm thickness 1.5mm Qty 1 pcs		

			
1			
Part No.	511651	Ref. No.	00-172986-022 172986-22
description	flat gasket rubber ED \varnothing 71mm ID \varnothing 59mm thickness 2mm for wash arm support Qty 1 pcs		
For models:	AMX, AMX-E, AMX-ER, AMX-R, AMXX-1300, AMXXR-1300, AMXXS-1300, AMXXT, AUX, AUX_, AUX-E, AUX-ER, AUX-R, AUXX-1300, AUXXL, AUXXR-1300, AUXXS-1300, AUXXT, CR, ECOMAX-700, UX, UX-30, UX-30B, UX-30E, UX-30EB, UX-30EH, UX-30ES, UX-30ESB, UX-30ESH, UX-30H, UX-30-McDonalds, UX-30S, UX-30SB, UX-30SH, UX-60, UX-60B, UX-60E, UX-60EB, UX-60EH, UX-60EHB, UX-60H, UX-60HB, UXD-30, UXL, UXLS, UXS, UXT, UXTH, UXTHL, UXTHLS...(Other models you can see in the webshop)		

			
1			
Part No.	524901	Ref. No.	371450-190
description	gasket for pump casing L 45mm W 13mm thickness 1mm rubber Qty 1m		
For models:	GF-60, GF-60S		

			
1			
Part No.	518071	Ref. No.	139321-915
description	gasket for wash arm support L 109mm W 68mm		





			
1			
Part No.	518116	Ref. No.	00-172986-019 172986-19
description	gasket for wash arm support rubber ø 60mm ID ø 47mm thickness 1mm		
For models:	AMX-900, AMXS-900, ECOMAX-402, ECOMAX-502, ECOMAX-650, FE, FE-W, FP, FX, FX-McDonalds, GC, GC11, GC12, GC31, GC32, GC41, GC42, GP, GX, HE, HE600-HL, HE-P, HX, HX-30, HX-30E, HX-30ES, HX-30S, HX-40, HX-40E, HX-40ES, HX-40S, HX-60-EHL, HX-E, HX-ES, HX-S		

			
1			
Part No.	524924	Ref. No.	226643
description	gasket for wash arm support Tesnit BA-50 ID ø 22mm L 71mm W 45mm thickness 2mm		
For models:	AM-12E, AM-12EC, AM-12EF, AM-12ER, FM-30, FM-30U, FM-400H, FM-400U, FM-500, FM-500H, UW-105, UW-120, UW-125, UW-200, UW-205, UW-55		

			
1			
Part No.	518238	Ref. No.	139321-742
description	manifold ø 12mm L 98mm		

			
1			
Part No.	517454	Ref. No.	308031
description	nut for wash arm ED ø 35mm thickness 11mm plastic		
For models:	ECOMAX-601, H-60		

			
1			
Part No.	518144	Ref. No.	00-883496-001 883496-1
description	nut for wash arm support ED ø 74mm WS 65 hole ø 36mm		
For models:	AM-10, AM-11, AM-141, AM900-10N, AM900-90, AMS900-10N, AMX, AMX-10HL, AMX-90, AMXR, AMXS, AMXT, AMXTS, ECOMAX-602-10, ECOMAX-602-11, ECOMAX-602S-11, ECOMAX-612-10, ECOMAX-612S-10		

			
1			
Part No.	518139	Ref. No.	01-240021-001 01-240021-1
description	nut for wash arm support ø 60mm		
For models:	ECOMAX-402, ECOMAX-502, FP, FX, FX-McDonalds, GP, GX		

			
1			
Part No.	524512	Ref. No.	324698-1
description	nut for wash arm support ø 74mm		
For models:	AMX, AMX-E, AMX-ER, AMX-R, AMXX-1300, AMXXR-1300, AMXXS-1300, AMXXT, AUX, AUX., AUX-E, AUX-ER, AUX-R, AUXX-1300, AUXXL, AUXXR-1300, AUXXS-1300, AUXXT, ECOMAX-700, UX, UX-30, UX-30B, UX-30E, UX-30EB, UX-30EH, UX-30ES, UX-30ESB, UX-30ESH, UX-30H, UX-30-McDonalds, UX-30S, UX-30SB, UX-30SH, UX-60, UX-60B, UX-60E, UX-60EB, UX-60EH, UX-60EHB, UX-60H, UX-60HB, UXD-30, UXL, UXLs, UXS, UXT, UXTH, UXTHL, UXTHLS, UXTHS...(Other models you can see in the webshop)		

			
1			
Part No.	524684	Ref. No.	885500-1
description	plug for wash arm ø 43mm ID ø 27mm		
For models:	CN, CNA, CNB, CNR, CSA, ECOMAX-800, FTN		

			
1			
Part No.	518443	Ref. No.	139321-766
description	rinse arm support mounting pos. upper		

			
1			
Part No.	511634	Ref. No.	296092
description	rinse arm support mounting pos. upper ø 15mm H 42.5mm		
For models:	AM-12E, AM-12EC, AM-12EF, AM-12ER, AM-600, AM-600C, AM-600CR, AM-600R, UW-100, UW-105, UW-120, UW-125, UW-135, UW-135H, UW-200, UW-205		



Part No.	518125	Ref. No.	139321-926
description	rinse hose ø 17.5mm		



Part No.	518148	Ref. No.	01-240097-001 01-240097-1
description	rinse pipe ø 17mm L 60mm		
For models:	ECOMAX-402, ECOMAX-502, FP, FX, FX-McDonalds, GP, GX		



Part No.	518149	Ref. No.	00-883479-002 883479-2
description	rinse pipe ø 17mm L 69mm		
For models:	AM-10, AM-11, AM-141, ECOMAX-602-10, ECOMAX-602-11, ECOMAX-602S-11, ECOMAX-612-10, ECOMAX-612S-10		



Part No.	518003	Ref. No.	139321-28 139321-872
description	screw cap		
For models:	GE-400, GW-600, GW-600S, GW-601, GW-601S		



Part No.	518288	Ref. No.	139321-921
description	screw connection		



Part No.	524922	Ref. No.	898263-1
description	shim for wash arm support ID ø 49mm ED ø 70mm H 3mm		
For models:	AM-700, AM900, AMS900, AMX-900, AMXR-900, AMXS-900, ECOMAX-600, ECOMAX-650		



Part No.	518127	Ref. No.	119227 B119227
description	slide ring for wash arm mounting pos. upper/lower ED ø 40mm ID ø 19.4mm thickness 6.2mm		
For models:	AM-12E, AM-12EC, AM-12EF, AM-12ER, LM-12E, UW-100, UW-105, UW-120, UW-125, UW-135, UW-135H, UW-200, UW-205		



Part No.	518119	Ref. No.	00-774072-001 774072-1
description	slide ring PTFE ED ø 19mm ID ø 14.5mm thickness 0.5mm for rinse arm Qty 1 pcs suitable for HOBART		
For models:	AM-10, AM-11, AM-141, AM-700, AM900, AM900-10N, AM900-90, AMS900, AMS900-10N, AMX, AMX-10HL, AMX-90, AMX-900, AMX-E, AMX-ER, AMXR, AMX-R, AMXR-900, AMXS, AMXS-900, AMXT, AMXTS, AMXX, AMXX-1300, AMXXR, AMXXR-1300, AMXXS, AMXXS-1300, AMXXT, AUP, AUP-90, AUPS, AUX, AUX_, AUX-E, AUX-ER, AUX-R, AUXX, AUXX-1300, AUXXL, AUXXL-11N, AUXXLS-11N, AUXXR, AUXXR-1300, AUXXS, AUXXS-1300, AUXXT, AUXXTS, ECOMAX-402, ECOMAX-502... (Other models you can see in the webshop)		





Part No.	518120	Ref. No.	00-774072-002 774072-2
description	slide ring PTFE ED ø 21mm ID ø 16mm thickness 0.5mm for rinse arm Qty 1 pcs		
For models:	AM-10, AM-11, AM-141, AM-700, AM900, AM900-10N, AM900-90, AMS900, AMS900-10N, AMX, AMX-10HL, AMX-90, AMX-900, AMX-E, AMX-ER, AMXR, AMX-R, AMXR-900, AMXS, AMXS-900, AMXT, AMXTS, AMXX, AMXX-1300, AMXXR, AMXXR-1300, AMXXS, AMXXS-1300, AMXXT, AUP, AUP-90, AUPS, AUX, AUX_, AUX-E, AUX-ER, AUX-R, AUXX, AUXX-1300, AUXXL, AUXXL-11N, AUXXLS-11N, AUXXR, AUXXR-1300, AUXXS, AUXXS-1300, AUXXT, AUXXTS, ECOMAX-402, ECOMAX-502... (Other models you can see in the webshop)		





Part No.	511678	Ref. No.	00-774072-007 774072-7
description	slide ring PTFE ED ø 24mm ID ø 13mm thickness 1mm for rinse arm Qty 1 pcs		
For models:	AM-10, AM-11, AM-141, AMX, AMX-10HL, AMX-90, AMXR, AMXS, AMXX, AMXXR, AMXXS, AUP, AUP-90, AUPS, AUXX, AUXXR, AUXXS, ECOMAX-402, ECOMAX-502, ECOMAX-602-10, ECOMAX-602-11, ECOMAX-602S-11, ECOMAX-612-10, ECOMAX-612S-10, FP, FX, FX-McDonalds, GP, GX		







			
1			
Part No.	513270	Ref. No.	139321-920
description	throttle disc		



			
1			
Part No.	510112	Ref. No.	139321-107 139321-873
description	Thumb screw thread M10 thread L 10mm ø 22mm H 4.5mm SS		
For models:	GE-400, GW-600, GW-600S, GW-601, GW-601S		

			
1			
Part No.	511679	Ref. No.	00-324071-000
description	T-piece connection 17.5mm plastic L 80mm W 40mm connection 1: 13.5mm connection 2: 13.5mm suitable for HOBART		
For models:	AM-10, AM-11, AM-141, AM900-10N, AM900-90, AMS900-10N, AMX, AMX-10HL, AMX-90, AMXR, AMXS, AMXT, AMXTS, AMXX, AMXXR, AMXXS, AUP, AUP-90, AUPS, AUXX, AUXXL-11N, AUXXLS-11N, AUXXR, AUXXS, AUXXT, AUXXTS, ECOMAX-402, ECOMAX-602-10, ECOMAX-602-11, ECOMAX-602S-11, ECOMAX-612-10, ECOMAX-612S-10, ECOMAX-700, FE, FP, FX, FX-McDonalds, GC, GC11, GC12, GC31, GC32, GP, GX, UX, UXL, UXLS, UXS, UXT, UXTH... (Other models you can see in the webshop)		
accessories for	511679		
			
Part No.	520573	Ref. No.	00-324510-202 324510-202
description	hose clamp ø 20mm wire gauge ø 2mm Qty 1 pcs		

			
1			
Part No.	524880	Ref. No.	883974-001 883974-1
description	wash arm bearing mounting pos. upper/lower ø 22mm H 37mm thread 3/4"		



			
1			
Part No.	524831	Ref. No.	01-510702-1 883974-002 883974-2
description	wash arm bearing mounting pos. upper/lower ø 22mm H 53mm with nut thread 3/4"		

			
1			
Part No.	518079	Ref. No.	734803-1
description	wash arm bearing with nut		
For models:	AM-700, AM900, AMS900, AMX-900, AMXR-900, AMXS-900, ECOMAX-600, ECOMAX-650, FE, FE-W, FX, GX, HE, HE600-HL, HE-P, HX, HX-60-EHL, HX-E, HX-ES, HX-S		
spare parts for	518079		
			
Part No.	510634	Ref. No.	324042
description	wash arm bearing ø 22mm H 39mm		
			
Part No.	510637	Ref. No.	324043
description	nut for wash arm support		

			
1			
Part No.	513714	Ref. No.	139321-906
description	wash pipe		
spare parts for	513714		
			
Part No.	518141	Ref. No.	—
description	wash arm support thread M46x2 ø 44mm ID ø 39mm L 112.5mm W 86mm hole ø 12mm		

			
1			
Part No.	518633	Ref. No.	139321-643
description	wash pipe		
For models:	CHF45, EF-40		







			
1			
Part No.	511670	Ref. No.	00-883529-001 883529-1
description	wash pipe ø 28x56mm stainless steel L-shape L1 685mm L2 275mm		
For models:	AM-10, AM-11, AM-141, AM900-10N, AM900-90, AMS900-10N, AMX, AMX-10HL, AMX-90, AMXR, AMXS, AMXT, AMXTS, AMXX, AMXXR, AMXXS, AUP, AUP-90, AUPS, AUXX, AUXXR, AUXXS, AUXXT, AUXXTS, ECOMAX-602-10, ECOMAX-602-11, ECOMAX-602S-11, ECOMAX-612-10, ECOMAX-612S-10		
accessories for	511670		
	Part No.	507497	Ref. No. 00-883481-001 883481-1
	connection wash pipe ø 47mm connection 66x36mm		



washing and rinsing systems (sorted by producer)

HOBART

			
1			
Part No.	513145	Ref. No.	139321-943
description	wash arm L 510mm nozzles 10 mounting ø 16mm mounting pos. upper and bottom		
For models:	CHH-50, CHH-60D, CHH-70D, EH-60, EH-70		

			
1			
Part No.	503507	Ref. No.	227049 227051 D-227049
description	wash arm L 546mm nozzles 8 mounting ø 19/81mm mounting pos. lower		
For models:	AM-12E, AM-12EC, AM-12EF, AM-12ER, AM-600, AM-600C, AM-600CR, AM-600R, LM-12E, UW-100, UW-105, UW-120, UW-125, UW-135, UW-135H, UW-200, UW-205		
spare parts for	503507		
	Part No.	518127	Ref. No. 119227 B119227
	slide ring for wash arm mounting pos. upper/lower ED ø 40mm ID ø 19.4mm thickness 6.2mm		

			
1			
Part No.	524657	Ref. No.	01-294032-001 01-294032-1
description	wash arm L 390mm nozzles 7 mounting ø 17/45mm		
For models:	ECOMAX-402		
spare parts for	524657		
	Part No.	524665	Ref. No. 01-240028-001 01-240028-1
	blank nozzle for cleaning M20		
accessories for	524657		
	Part No.	518153	Ref. No. 01-294038-001 01-294038-1
	wash arm support mounting pos. upper		

			
1			
Part No.	524645	Ref. No.	01-240050-001 01-240050-1
description	wash arm L 515mm nozzles 8 mounting ø 17/45mm mounting pos. upper/lower		
For models:	AM-10, AM-11, AM-141, ECOMAX-502, ECOMAX-602-10, ECOMAX-602-11, ECOMAX-602S-11, ECOMAX-612-10, ECOMAX-612S-10, FP, FX, FX-McDonalds, GP, GX		
spare parts for	524645		
	Part No.	524665	Ref. No. 01-240028-001 01-240028-1
	blank nozzle for cleaning M20		



			
1			
Part No.	524665	Ref. No.	01-240028-001 01-240028-1
description	blank nozzle for cleaning M20		
For models:	AM-10, AM-11, AM-141, ECOMAX-402, ECOMAX-502, ECOMAX-602-10, ECOMAX-602-11, ECOMAX-602S-11, ECOMAX-612-10, ECOMAX-612S-10, FP, FX, FX-McDonalds, GP, GX		







			
1			
Part No.	518629	Ref. No.	324039 324444 883472-1
description	wash arm L 512mm nozzles 8 mounting ø 16/45.5mm mounting pos. upper and bottom		
For models:	AM-700, AM900, AMS900, AMX-900, AMXR-900, AMXS-900, ECOMAX-600, ECOMAX-650, FE, FE-W, FX, HE, HE600-HL, HE-P, HX, HX-30, HX-30E, HX-30ES, HX-30S, HX-40, HX-40E, HX-40ES, HX-40S, HX-60-EHL, HX-E, HX-ES, HX-S		

			
1			
Part No.	517587	Ref. No.	00-886898-001 324738 324831 886898-1
description	rinse arm mounting pos. lower L 680mm nozzles 11 thread 1/4"		
For models:	ECOMAX-700, UX, UX-30, UX-30B, UX-30E, UX-30EB, UX-30EH, UX-30ES, UX-30ESB, UX-30ESH, UX-30H, UX-30-McDonalds, UX-30S, UX-30SB, UX-30SH, UX-60, UX-60B, UX-60E, UX-60EB, UX-60EH, UX-60EHB, UX-60H, UX-60HB, UXL, UXLS, UXS, UXT, UXTH, UXTHL, UXTHLS, UXTHS, UXTL, UXTLH, UXTLHS, UXTLS, UXTS		

			
1			
Part No.	517589	Ref. No.	00-324614-000 324798-1 883453-1
description	wash arm L 535mm nozzles 16		
For models:	AMX, AMX-E, AMX-ER, AMX-R, AMXX-1300, AMXXR-1300, AMXXS-1300, AMXXT, AUX, AUX_, AUX-E, AUX-ER, AUX-R, AUXX-1300, AUXXL, AUXXR-1300, AUXXS-1300, AUXXT, UXD-30		

			
1			
Part No.	517588	Ref. No.	01-240096-001 01-240096-1 323805 883126
description	rinse arm mounting pos. upper/lower L 520mm nozzles 9 thread 1/4"		
For models:	AM-700, ECOMAX-600, ECOMAX-650, FE, HE, HE600-HL, HE-P		
spare parts for	517588		
	Part No.	510636	Ref. No. 324172 867429-1 886609
end cap for rinse arm set 4-piece			

			
1			
Part No.	517590	Ref. No.	00-324691-000 00-324798-002 324798-2
description	wash arm mounting pos. upper/lower L 690mm nozzles 20		
For models:	ECOMAX-700, UX, UX-30, UX-30B, UX-30E, UX-30EB, UX-30EH, UX-30ES, UX-30ESB, UX-30ESH, UX-30H, UX-30-McDonalds, UX-30S, UX-30SB, UX-30SH, UX-60, UX-60B, UX-60E, UX-60EB, UX-60EH, UX-60EHB, UX-60H, UX-60HB, UXL, UXLS, UXS, UXT, UXTH, UXTHL, UXTHLS, UXTHS, UXTL, UXTLH, UXTLHS, UXTLS, UXTS		



			
1			
Part No.	518112	Ref. No.	324039 324444 883472-1 old
description	wash arm L 512mm nozzles 8 mounting ø 16/45.5mm mounting pos. upper and bottom		
spare parts for	518112		
	Part No.	510636	Ref. No. 324172 867429-1 886609
end cap for rinse arm set 4-piece			
	Part No.	518079	Ref. No. 734803-1
wash arm bearing with nut			
accessories for	518112		
	Part No.	518598	Ref. No. 324067
rinse arm shaft			



			
1			
Part No.	517585	Ref. No.	00-324785-000 886610
description	end cap for wash arm ø 28mm H 10mm Qty 4 pcs		
For models:	AMX, AMX-E, AMX-ER, AMX-R, AMXX-1300, AMXXR-1300, AMXXS-1300, AMXXT, AUX, AUX_, AUX-E, AUX-ER, AUX-R, AUXX-1300, AUXXL, AUXXR-1300, AUXXS-1300, AUXXT, ECOMAX-700, UX, UX-30, UX-30B, UX-30E, UX-30EB, UX-30EH, UX-30ES, UX-30ESB, UX-30ESH, UX-30H, UX-30-McDonalds, UX-30S, UX-30SB, UX-30SH, UX-60, UX-60B, UX-60E, UX-60EB, UX-60EH, UX-60EHB, UX-60H, UX-60HB, UXL, UXLS, UXS, UXT, UXTH, UXTHL, UXTHLS, UXTHS...(Other models you can see in the webshop)		







			
1			
Part No.	510636	Ref. No.	324172 867429-1 886609
description	end cap for rinse arm set 4-piece		
For models:	AM-700, AM900, AMS900, AMX, AMX-900, AMX-E, AMX-ER, AMX-R, AMXR-900, AMXS-900, AMXX-1300, AMXXR-1300, AMXXS-1300, AMXXT, AUX, AUX_, AUX-E, AUX-ER, AUX-R, AUXX-1300, AUXXL, AUXXR-1300, AUXXS-1300, AUXXT, ECOMAX-600, ECOMAX-650, ECOMAX-700, FE, FE-W, FX, GX, HE, HE600-HL, HE-P, HX, HX-30, HX-30E, HX-30ES, HX-30S, HX-40, HX-40E, HX-40ES, HX-40S, HX-60-EHL, HX-E, HX-ES, HX-S, UX, UX-30, UX-30B...(Other models you can see in the webshop)		

			
1			
Part No.	524658	Ref. No.	01-294029-001 01-294029-1
description	rinse arm L 395mm nozzles 7 mounting \varnothing 14mm with rinse arm shaft		
For models:	ECOMAX-402		

spare parts for 524658			
	Part No.	511678	Ref. No. 00-774072-007 774072-7
	slide ring PTFE ED \varnothing 24mm ID \varnothing 13mm thickness 1mm for rinse arm Qty 1 pcs		
	Part No.	518119	Ref. No. 00-774072-001 774072-1
	slide ring PTFE ED \varnothing 19mm ID \varnothing 14.5mm thickness 0.5mm for rinse arm Qty 1 pcs suitable for HOBART		
	Part No.	518120	Ref. No. 00-774072-002 774072-2
	slide ring PTFE ED \varnothing 21mm ID \varnothing 16mm thickness 0.5mm for rinse arm Qty 1 pcs		

			
1			
Part No.	524659	Ref. No.	01-240096-003 01-240096-3
description	rinse arm L 515mm nozzles 8 mounting \varnothing 16mm with rinse arm shaft edition FX		
For models:	AM-10, AM-11, AM-141, ECOMAX-502, ECOMAX-602-10, ECOMAX-602-11, ECOMAX-602S-11, ECOMAX-612-10, ECOMAX-612S-10, FP, FX, FX-McDonalds, GP, GX		
spare parts for 524659			
	Part No.	511678	Ref. No. 00-774072-007 774072-7
	slide ring PTFE ED \varnothing 24mm ID \varnothing 13mm thickness 1mm for rinse arm Qty 1 pcs		
	Part No.	518119	Ref. No. 00-774072-001 774072-1
	slide ring PTFE ED \varnothing 19mm ID \varnothing 14.5mm thickness 0.5mm for rinse arm Qty 1 pcs suitable for HOBART		

spare parts for 524659			
	Part No.	518120	Ref. No. 00-774072-002 774072-2
	slide ring PTFE ED \varnothing 21mm ID \varnothing 16mm thickness 0.5mm for rinse arm Qty 1 pcs		
	Part No.	518147	Ref. No. 01-240095-001 01-240095-1
	rinse arm shaft		
	Part No.	518152	Ref. No. 01-240205-001 01-240205-1 324036
	knurled nut thread M12x1 \varnothing 32mm H 3mm mounting pos. upper/lower SS for wash arm ID \varnothing 11.5mm ED \varnothing 32mm thickness 3mm		

			
1			
Part No.	503183	Ref. No.	01-240096-004 01-240096-4
description	rinse arm L 520mm mounting pos. upper/lower nozzles 8		
For models:	AM900-10N, AM900-90, AMS900-10N, AMX, AMX-10HL, AMX-90, AMXR, AMXS, AMXT, AMXTS, AMXX, AMXXR, AMXXS, AUP, AUP-90, AUPS, AUX, AUXXL-11N, AUXXLS-11N, AUXXR, AUXXS, AUXXT, AUXXTS		

			
1			
Part No.	503161	Ref. No.	00-324052-000 00-324445-000 01-240096-002 01-240096-2
description	rinse arm L 520mm nozzles 9 mounting \varnothing 16mm		
For models:	AM900, AMS900, AMX, AMX-900, AMX-E, AMX-ER, AMX-R, AMXR-900, AMXS-900, AMXX-1300, AMXXR-1300, AMXXS-1300, AMXXT, AUX, AUX_, AUX-E, AUX-ER, AUX-R, AUXX-1300, AUXXL, AUXXR-1300, AUXXS-1300, AUXXT, ECOMAX-650, FE, FX, GX, HE-P, HX, HX-30, HX-30E, HX-30ES, HX-30S, HX-40, HX-40E, HX-40ES, HX-40S, HX-60-EHL, HX-E, HX-ES, HX-S, UXD-30		





			
1			
Part No.	503508	Ref. No.	296093-2
description	rinse arm L 515mm nozzles 10 mounting ø 8/19mm mounting pos. upper		
For models:	UW-120, UW-125, UW-135, UW-135H, UW-200, UW-205		
spare parts for	503508		
	Part No.	504574	Ref. No. 67500-30
	O-ring EPDM thickness 1.78mm ID ø 9.25mm Qty 1 pcs		
	Part No.	510648	Ref. No. 226800-3
	rinse jet		
	Part No.	511656	Ref. No. 00-172986-018 172986-18
	flat gasket rubber ED ø 13mm ID ø 7.5mm thickness 0.5mm Qty 1 pcs		
	Part No.	518114	Ref. No. 228643 B228643
	bush for rinse arm ø 14mm H 21mm		
	Part No.	520498	Ref. No. 226816
	end cap for rinse arm ø 16mm H 11mm		
	Part No.	697871	Ref. No. 602309 RR-E-2-38
	retaining ring A D1 ø 14mm D2 ø 12.8mm spring steel DIN 7993 thickness 1mm		



			
1			
Part No.	520498	Ref. No.	226816
description	end cap for rinse arm ø 16mm H 11mm		
For models:	AM-12E, AM-12EC, AM-12EF, AM-12ER, AM-600, AM-600C, AM-600CR, AM-600R, FM-30, FM-30U, FM-400H, FM-400U, FM-500, FM-500H, UW-100, UW-105, UW-120, UW-125, UW-135, UW-135H, UW-200, UW-205, UW-55		



			
1			
Part No.	511656	Ref. No.	00-172986-018 172986-18
description	flat gasket rubber ED ø 13mm ID ø 7.5mm thickness 0.5mm Qty 1 pcs		
For models:	CX, FM-400H, FM-400U, FM-500, FM-500H, FTT, UW-105, UW-120, UW-125, UW-135, UW-135H, UW-200, UW-205, UW-55, UWX		



			
1			
Part No.	510648	Ref. No.	226800-3
description	rinse jet		
For models:	CX, FM-500, FM-500H, UW-100, UW-105, UW-120, UW-125, UW-135, UW-135H, UW-200, UW-205, UW-55, UWX		



			
1			
Part No.	524829	Ref. No.	775762-1
description	wash and rinse arm mounting pos. upper/lower wash arm L 395mm rinse arm L 395mm w. jets 6 r. jets 6 mounting ø 45/17mm		
For models:	GC, GC11, GC12, GC31, GC32, GC41, GC42		



			
1			
Part No.	517559	Ref. No.	139321-870 E990109
description	wash arm wash arm L 500mm rinse arm L 495mm w. jets 9 r. jets 5		

			
1			
Part No.	518419	Ref. No.	139321-784 139321-944
description	end cap for rinse arm		
For models:	CHH-70D, CLG-25, EH-70		
accessories for	518419		
	Part No.	528485	Ref. No. —
	O-ring EPDM thickness 1.78mm ID ø 6.07mm Qty 1 pcs		

			
1			
Part No.	518416	Ref. No.	139321-786
description	opposite support for rinse jet		
accessories for	518416		
	Part No.	560062	Ref. No. 603455
	flat-headed bolt thread M4 thread L 10mm SS DIN 7985/ISO 7045 Qty 20 pcs intake Phillips head ø 8mm head thickness 2mm		
	Part No.	560131	Ref. No. —
	hexagonal nut thread M4 H 3.2mm WS 7 SS DIN/ISO DIN 934 / ISO 4032/8673 Qty 20 pcs		

			
1			
Part No.	513055	Ref. No.	139321-785
description	rinse jet		
accessories for	513055		
	Part No.	560062	Ref. No. 603455
	flat-headed bolt thread M4 thread L 10mm SS DIN 7985/ISO 7045 Qty 20 pcs intake Phillips head ø 8mm head thickness 2mm		
	Part No.	560131	Ref. No. —
	hexagonal nut thread M4 H 3.2mm WS 7 SS DIN/ISO DIN 934 / ISO 4032/8673 Qty 20 pcs		

			
1			
Part No.	518333	Ref. No.	139321-871
description	wash arm mounting pos. left L 220mm mounting ø 24mm nozzles 4		
accessories for	518333		
	Part No.	518004	Ref. No. 139321-32
	wash jet		
	Part No.	518272	Ref. No. —
	union nut for wash jet		

			
1			
Part No.	518332	Ref. No.	139321-875
description	wash arm mounting pos. right L 220mm mounting ø 24mm nozzles 5		
accessories for	518332		
	Part No.	518004	Ref. No. 139321-32
	wash jet		
	Part No.	518272	Ref. No. —
	union nut for wash jet		



			
1			
Part No.	510010	Ref. No.	139321-35
description	wash arm boss L1 64mm L2 60mm mounting ø 16.5mm		
For models:	GE-400, GW-600, GW-600S, GW-601, GW-601S		



			
1			
Part No.	518004	Ref. No.	139321-32
description	wash jet		

			
1			
Part No.	518117	Ref. No.	226800-1
description	rinse jet ø 7.5mm H 21.5mm		
For models:	AM-12E, AM-12EC, AM-12EF, AM-12ER, FM-30, FM-30U, UW-100		

			
1			
Part No.	512474	Ref. No.	01-240631-002
description	nut for wash arm support mounting pos. lower ED ø 60mm ID ø 36mm H 72mm connection ø 42mm		



			
1			
Part No.	518171	Ref. No.	139321-842
description	opposite support mounting pos. lower for wash arm support		

			
1			
Part No.	518069	Ref. No.	139321-916
description	wash arm support		
accessories for	518069		
	Part No.	518071	Ref. No. 139321-915
	gasket for wash arm support L 109mm W 68mm		

			
1			
Part No.	530467	Ref. No.	ML102842
description	wash arm support kit H 56mm D1 ø 50mm ID ø 36mm		
accessories for	530467		
	Part No.	530468	Ref. No. 493414
	bushing for rinse arm mounting pos. upper/lower ø 15mm ID ø 12mm H 16mm		



			
1			
Part No.	524680	Ref. No.	324670 886607
description	wash arm support kit mounting pos. upper ø 62mm H 112mm ID ø 51mm		
For models:	AMX, AMX-E, AMX-ER, AMX-R, AMXX-1300, AMXXR-1300, AMXXS-1300, AMXXT, AUX, AUX_, AUX-E, AUX-ER, AUX-R, AUXX-1300, AUXXL, AUXXR-1300, AUXXS-1300, AUXXT, UX-30, UX-30B, UX-30E, UX-30EB, UX-30EH, UX-30ES, UX-30ESB, UX-30ESH, UX-30H, UX-30-McDonalds, UX-30S, UX-30SB, UX-30SH, UX-60, UX-60B, UX-60E, UX-60EB, UX-60EH, UX-60EHB, UX-60H, UX-60HB, UXD-30, UXTH, UXTHL, UXTHLS, UXTHS, UXTLH, UXTLHS		





 <p>1</p>			
Part No.	518145	Ref. No.	00-883488-001 883488-1
description	wash arm support mounting pos. lower		
For models:	AM-10, AM-11, AM-141, AM900-10N, AM900-90, AMS900-10N, AMX, AMX-10HL, AMX-90, AMXR, AMXS, AMXT, AMXTS, AMXX, AMXXR, AMXXS, AUP, AUP-90, AUPS, AUXX, AUXXL-11N, AUXXLS-11N, AUXXR, AUXXS, AUXXT, AUXXTS, ECOMAX-602-10, ECOMAX-602-11, ECOMAX-602S-11, ECOMAX-612-10, ECOMAX-612S-10		
accessories for	518145		
	Part No.	517403	Ref. No. 00-172986-035 172986-35
	flat gasket EPDM ED ø 71mm ID ø 61mm thickness 1.5mm Qty 1 pcs		
	Part No.	518143	Ref. No. 00-775933-003 01-515356-001 775933-3
	slide ring for wash arm ED ø 46mm ID ø 41mm thickness 3mm		
	Part No.	518144	Ref. No. 00-883496-001 883496-1
	nut for wash arm support ED ø 74mm WS 65 hole ø 36mm		



 <p>1</p>			
Part No.	524669	Ref. No.	898194-1
description	wash arm support mounting pos. lower		
For models:	AM-700, AM900, AMS900, AMX-900, AMXR-900, AMXS-900, ECOMAX-600, ECOMAX-650		

 <p>1</p>			
Part No.	518146	Ref. No.	00-883467-001 883467-1
description	wash arm support mounting pos. upper		
For models:	AM-10, AM-11, AM-141, AM900-10N, AM900-90, AMS900-10N, AMX, AMX-10HL, AMX-90, AMXR, AMXS, AMXT, AMXTS, ECOMAX-602-10, ECOMAX-602-11, ECOMAX-602S-11, ECOMAX-612-10, ECOMAX-612S-10		

 <p>1</p>			
Part No.	518153	Ref. No.	01-294038-001 01-294038-1
description	wash arm support mounting pos. upper		
For models:	ECOMAX-402, ECOMAX-502		
accessories for	518153		
	Part No.	518116	Ref. No. 00-172986-019 172986-19
	gasket for wash arm support rubber ø 60mm ID ø 47mm thickness 1mm		
	Part No.	518139	Ref. No. 01-240021-001 01-240021-1
	nut for wash arm support ø 60mm		

accessories for	518153		
	Part No.	518143	Ref. No. 00-775933-003 01-515356-001 775933-3
	slide ring for wash arm ED ø 46mm ID ø 41mm thickness 3mm		
	Part No.	518148	Ref. No. 01-240097-001 01-240097-1
	rinse pipe ø 17mm L 60mm		

 <p>1</p>			
Part No.	518115	Ref. No.	324268 324480
description	wash arm support mounting pos. upper kit HE, HX suitable for HOBART		
For models:	AM-700, AM900, AMS900, AMX-900, AMXR-900, AMXS-900, ECOMAX-600, ECOMAX-650, HE, HE600-HL, HE-P, HX, HX-30, HX-30E, HX-30ES, HX-30S, HX-40, HX-40E, HX-40ES, HX-40S, HX-60-EHL, HX-E, HX-ES, HX-S		

 <p>1</p>			
Part No.	510634	Ref. No.	324042
description	wash arm bearing ø 22mm H 39mm		
For models:	FE, FE-W, FX, GX, HE, HX-30, HX-30E, HX-30ES, HX-30S, HX-40, HX-40E, HX-40ES, HX-40S		
accessories for	510634		
	Part No.	510637	Ref. No. 324043
	nut for wash arm support		

 <p>1</p>			
Part No.	505253	Ref. No.	324727 324729+324728+324730 734804.1
description	wash arm bearing ø 24mm H 58mm		
For models:	AMX, AMX-E, AMX-ER, AMX-R, AMXX-1300, AMXXR-1300, AMXXS-1300, AMXXT, AUX, AUX_, AUX-E, AUX-ER, AUX-R, AUXX-1300, AUXXL, AUXXR-1300, AUXXS-1300, AUXXT, ECOMAX-700, UX, UX-30, UX-30B, UX-30E, UX-30EB, UX-30EH, UX-30ES, UX-30ESB, UX-30ESH, UX-30H, UX-30-McDonalds, UX-30S, UX-30SB, UX-30SH, UX-60, UX-60B, UX-60E, UX-60EB, UX-60EH, UX-60EHB, UX-60H, UX-60HB, UXD-30, UXL, UXLS, UXS, UXT, UXTH, UXTHL, UXTHLS, UXTHS...(Other models you can see in the webshop)		

1 mechanical components, equipment accessories



1

Part No.	510635	Ref. No.	231893-1
description	nut for wash arm support		
For models:	AM-700, AM900, AMS900, AMX-900, AMXR-900, AMXS-900, ECOMAX-600, ECOMAX-650, FE, FE-W, FX, GX, HE, HE600-HL, HE-P, HX, HX-30, HX-30E, HX-30ES, HX-30S, HX-40, HX-40E, HX-40ES, HX-40S, HX-60-EHL, HX-E, HX-ES, HX-S		



1

Part No.	510637	Ref. No.	324043
description	nut for wash arm support		
For models:	FE, FE-W, FX, GX, HE, HX-30, HX-30E, HX-30ES, HX-30S, HX-40, HX-40E, HX-40ES, HX-40S		

rinse arm shafts



1

Part No.	518170	Ref. No.	139321-883
description	extension for rinse arm shaft		



1

Part No.	510108	Ref. No.	139321-113 139321-868
description	rinse arm shaft		
For models:	GE-400, GW-600, GW-600S, GW-601, GW-601S		



1

Part No.	513159	Ref. No.	139321-947
description	rinse arm shaft		
For models:	CHH-70D, EH-70		



1

Part No.	513160	Ref. No.	139321-918 E80282
description	rinse arm shaft		



1

Part No.	518147	Ref. No.	01-240095-001 01-240095-1
description	rinse arm shaft		
For models:	AM-10, AM-11, AM-141, AM900-10N, AM900-90, AMS900-10N, AMX, AMX-10HL, AMX-90, AMXR, AMXS, AMXT, AMXTS, AMXX, AMXXR, AMXXS, AUP, AUP-90, AUPS, AUXX, AUXXL-11N, AUXXLS-11N, AUXXR, AUXXS, AUXXT, AUXXTS, ECOMAX-402, ECOMAX-502, ECOMAX-602-10, ECOMAX-602-11, ECOMAX-602S-11, ECOMAX-612-10, ECOMAX-612S-10, FP, FX, FX-McDonalds, GP, GX		



1

Part No.	518598	Ref. No.	324067
description	rinse arm shaft		
For models:	AM-700, AM900, AMS900, AMX, AMX-900, AMX-E, AMX-ER, AMX-R, AMXR-900, AMXS-900, AMXX-1300, AMXXT, AUX, AUX_, AUX-E, AUXER, AUX-R, AUXX-1300, AUXXL, AUXXT, ECOMAX-600, ECOMAX-650, FE, FE-W, FX, GX, HE, HE600-HL, HE-P, HX, HX-30, HX-30E, HX-30ES, HX-30S, HX-40, HX-40E, HX-40ES, HX-40S, HX-60-EHL, HX-E, HX-ES, HX-S, UXD-30		



1

Part No.	524686	Ref. No.	324040
description	rinse arm shaft \varnothing 16mm H 59.5mm thread M16x2 thread L 14mm		
For models:	AM-700, AM900, AMS900, AMX-900, AMXR-900, AMXS-900, ECOMAX-600, ECOMAX-650, FE, FE-W, FX, GX, HE, HE600-HL, HE-P, HX, HX-30, HX-30E, HX-30ES, HX-30S, HX-40, HX-40E, HX-40ES, HX-40S, HX-60-EHL, HX-E, HX-ES, HX-S		

wash pipes

wash pipes



1

Part No.	513715	Ref. No.	115113 139321-866
description	wash pipe		
For models:	ECOMAX-500		

accessories for	513715		
------------------------	--------	--	--

Part No.	518339	Ref. No.	139321-864
-----------------	--------	-----------------	------------

	description	gasket D2 \varnothing 50mm thickness 2mm with 3 screw holes wash arm support equiv. no. 437064 suitable for COLGED hole \varnothing 50mm hole distance 67mm	
--	--------------------	---	--

Part No.	518461	Ref. No.	139321-865
	description	flange for wash arm support	



locks

snap locks

producer-specific

HOBART



1

Part No.	701126	Ref. No.	324221
description	snap lock L 33mm with roller thread M12x1.75 for dishwasher		
For models:	ECOMAX-700, FE, FX, GX, UX-30, UX-30E, UX-30ES, UX-30-McDonalds, UX-30S, UX-60, UX-60E		

miscellaneous



1

Part No.	696420	Ref. No.	03811C
description	door catch with microswitch L 80mm W 46mm mounting distance 60mm		
spare parts for	696420		
	Part No.	347567	Ref. No.
			—
	momentary push switch mounting ø 12mm white 1NO 250V 4A connection male faston 6.3mm ambient temperature max. 85°C protection IP40		

hinges

door bearing



1

Part No.	701300	Ref. No.	01-240709-001 01-240709-1
description	door hinge L 90mm W 19mm H 29mm mounting pos. left bottom thickness 3mm		
For models:	ECOMAX-502		



1

Part No.	701301	Ref. No.	01-240709-002 01-240709-2
description	door hinge L 90mm W 19mm H 29mm mounting pos. right bottom thickness 3mm		
For models:	ECOMAX-502		

accessories

miscellaneous



1

Part No.	692307	Ref. No.	01-240789-001 01-240789-1
description	plain washer for hinge ID ø 8mm ED ø 18mm plastic thickness 1mm Qty 1 pcs		
For models:	ECOMAX-502		

fittings for catering equipment

drain taps

brass

drain taps



1

Part No.	541941	Ref. No.	313048
description	drain tap 1 1/2" IT L 124mm conical seal thread 1 1/2"		
accessories for	541941		
	Part No.	510404	Ref. No.
			—
	flat gasket fibre ED ø 44mm ID ø 34mm thickness 2mm Qty 1 pcs		

equipment feet and end caps

equipment feet

with screw mounting



1

Part No.	513287	Ref. No.	139321-683
description	equipment foot tube ø 60mm thread M12 thread L 33mm H 155-235mm SS size 2" Qty 1 pcs		



screw-in feet



Part No.	701101	Ref. No.	01-294066-001 01-294066-1
description	equipment foot thread M10 thread L 60mm ø 30mm H 10mm Qty 1 pcs suitable for HOBART		
For models:	ECOMAX-402, ECOMAX-502		



Part No.	513284	Ref. No.	371450-23
description	equipment foot thread M8 thread L 20mm ø 30mm H 12mm Qty 1 pcs		
For models:	GF-60, GF-60S		

baskets

crumb screens



Part No.	970521	Ref. No.	M160036
description	crumb screen L 382mm W 272mm H 130mm suitable for fryer		

warewashing baskets

steel wire baskets square

glass basket



Part No.	971017	Ref. No.	139321-58
description	glass basket L 382mm W 382mm H 170mm number of rows 3 rows spacing 120mm		
For models:	GW-600, GW-600S, GW-601, GW-601S		
spare parts for	971017		
	Part No.	970001	Ref. No. —
	sliding corner wire gauge ø 5mm L 120mm W 120mm H 12mm L-shape		



Part No.	971018	Ref. No.	139321-57
description	glass basket L 382mm W 382mm H 170mm number of rows 4 rows spacing 85mm inclined bottom		
For models:	GW-600, GW-600S, GW-601, GW-601S		

mix baskets



Part No.	971013 ¹	Ref. No.	139321-54
description	mix basket L 382mm W 382mm H 90mm mesh type wide-meshed		
For models:	GW-600, GW-600S, GW-601, GW-601S		

¹wide-meshed

gaskets

refrigeration gaskets

plug-in gaskets

profile 9793

We offer custom-made gaskets for this profile

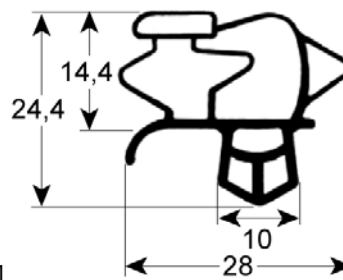

Part No.	900936	Ref. No.	74306
description	refrigeration gasket profile 9793 W 637mm L 1512mm plug size		

gaskets for heated units

door seals

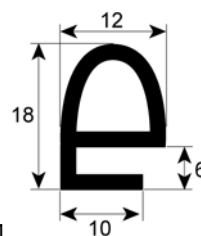

Part No.	901417	Ref. No.	492439 845052
description	door seal profile 2215 L 2010mm suitable for HOBART Qty 1		
For models:	CO-0612E, CS-0612E, CS-0612E-A, CSD-0612E, CSD-0612E-A, CSD-0612-UC, CSL-06E, CSM-0611IE, CSM-0611N		



Part No.	901366	Ref. No.	492466
description	door seal profile 2215 L 2530mm Qty 1 suitable for HOBART		
For models:	CO-1012E, CS-1012E, CS-1012E-A, CS-1012G, CS-1022E, CS-1022E-A, CSD-1012E, CSD-1012E-A, CSD-1012-UC, CSD-1013G, CSD-1022E, CSD-1022E-A, CSD-1022-UC, CSL-10E, CSM-1011E, CSM-1011N, CSM-1021E, CSM-1021N		

Part No.	902444	Ref. No.	01-235313 1235313 162007
description	door seal profile 2510 W 670mm L 775mm external size		

Part No.	518126	Ref. No.	492455
description	door seal profile 2980 L 2820mm		
For models:	CO-1012E, CS-1012E, CS-1012E-A, CS-1022E, CS-1022E-A, CSD-1012E, CSD-1012E-A, CSD-1013G, CSD-1022E, CSD-1022E-A, CSL-10E, CSM-1011E, CSM-1011N, CSM-1021E, CSM-1021N		

O-rings

EPDM

Part No.	512500	Ref. No.	01-245340-001 01-245340-1
description	O-ring EPDM thickness 0.2mm ID \varnothing 20mm Qty 1 pcs		
For models:	CN-Protronic, CN-Smartronic, CP-Protronic, CS-Easytronic		

Part No.	504574	Ref. No.	67500-30
description	O-ring EPDM thickness 1.78mm ID \varnothing 9.25mm Qty 1 pcs		
For models:	AM-12E, AM-12EC, AM-12EF, AM-12ER, AM-600, AM-600C, AM-600CR, AM-600R, CM1E, FM-30, FM-30U, FM-400H, FM-400U, FM-500, FM-500H, FX, GX, UW-100, UW-105, UW-120, UW-125, UW-135, UW-135H, UW-200, UW-205, UW-55, WM2E		

Part No.	529412	Ref. No.	139321-178
description	O-ring EPDM thickness 2.62mm ID \varnothing 10.78mm Qty 1 pcs		
For models:	AM-700, AM900, AMS900, AMX, AMX-900, AMX-E, AMX-ER, AMX-R, AMXR-900, AMXS-900, AMXX-1300, AMXXR-1300, AMXXS-1300, AMXXT, AUX, AUX_, AUX-E, AUX-ER, AUX-R, AUXX-1300, AUXXL, AUXXR-1300, AUXXS-1300, AUXXT, ECOMAX-600, ECOMAX-650, FE, FE-W, FX, GE-400, GW-600, GW-600S, GW-601, GW-601S, GX, HE, HE600-HL, HE-P, HX, HX-30, HX-30E, HX-30ES, HX-30S, HX-40, HX-40E, HX-40ES, HX-40S, HX-60-EHL, HX-E, HX-ES...(Other models you can see in the webshop)		

Part No.	518227	Ref. No.	139321-726
description	O-ring EPDM thickness 2.62mm ID \varnothing 12.37mm Qty 1 pcs		

Part No.	507313	Ref. No.	67500-7
description	O-ring EPDM thickness 2.62mm ID \varnothing 13.95mm Qty 1 pcs		
For models:	AMX, AMX-E, AMX-ER, AMX-R, AUX, AUX_, AUX-E, AUX-ER, AUX-R, M802, ML-104674, ML-104683, ML-104686, ML-104687, ML-104694, ML-104696, UX-30, UX-30B, UX-30E, UX-30EB, UX-30ES, UX-30ESB, UX-30S, UX-30SB, UX-60, UX-60B, UX-60E, UX-60EB, V1401		

Part No.	528919	Ref. No.	139321-49
description	O-ring EPDM thickness 2.62mm ID \varnothing 20.24mm Qty 1 pcs		
For models:	GE-400, GW-600, GW-600S, GW-601, GW-601S		

Part No.	518275	Ref. No.	139321-949
description	O-ring EPDM thickness 2.62mm ID \varnothing 6.02mm Qty 1 pcs		

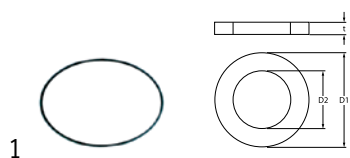

	Part No. 510554	Ref. No. 139321-888
	description O-ring EPDM thickness 2mm ID ø 120mm Qty 1 pcs	

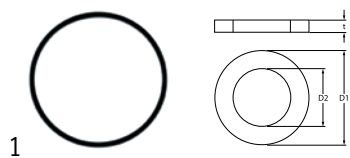
	Part No. 510009	Ref. No. 139321-52
	description O-ring EPDM thickness 3.53mm ID ø 101.2mm Qty 1 pcs	
For models: GE-400, GW-600, GW-600S, GW-601, GW-601S		

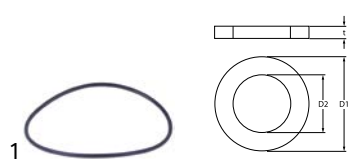
	Part No. 532537	Ref. No. 139321-469
	description O-ring EPDM thickness 3.53mm ID ø 113.9mm Qty 1 pcs	
For models: CHF45, EF-40		

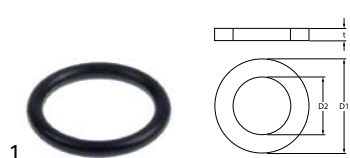
	Part No. 511322	Ref. No. 67500-72
	description O-ring EPDM thickness 3.53mm ID ø 20.22mm Qty 1 pcs	
For models: 103G, 203G, 2226, 303G, ACW, AM-12E, AM-12EC, AM-12EF, AM-12ER, AM-600, AM-600C, AM-600CR, AM-600R, CN, CNA, CNB, CNR, CR, CR-F, CSA, CX, ECOMAX-800, EWB-S, FTN, FTT, UW-100, UW-105, UW-135, UW-135H, UWX		

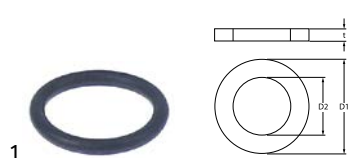
	Part No. 517087	Ref. No. 67500-11
	description O-ring EPDM thickness 3.53mm ID ø 23.4mm Qty 1 pcs	
For models: AMX, AMX-E, AMX-ER, AMX-R, AUX, AUX_, AUX-E, AUX-ER, AUX-R, CN, CNA, CNB, CNR, CR, CR-F, CSA, ECOMAX-800, FTN, UX-30, UX-30B, UX-30E, UX-30EB, UX-30ES, UX-30ESB, UX-30S, UX-30SB, UX-60, UX-60B, UX-60E, UX-60EB		

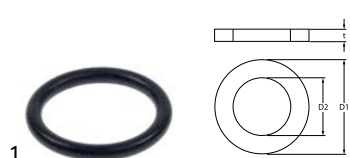
	Part No. 512501	Ref. No. 00-884505-002 884505-2
	description O-ring EPDM thickness 3.53mm ID ø 24.99mm Qty 1 pcs	
For models: CN, CNA, CNB, CN-Protronic, CNR, CN-Smartronic, CP-Protronic, CSA, CS-Easytronic, ECOMAX-800, FTN		

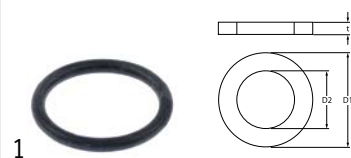
	Part No. 511937	Ref. No. 67500-12
	description O-ring EPDM thickness 3.53mm ID ø 28.17mm Qty 1 pcs	
For models: AM-700, AM900, AMS900, AMX-900, AMXR-900, AMXS-900, ECOMAX-600, ECOMAX-650, ECW, HE, HE600-HL, HE-P, HX, HX-30, HX-30E, HX-30ES, HX-30S, HX-40, HX-40E, HX-40ES, HX-40S, HX-60-EHL, HX-E, HX-ES, HX-S		

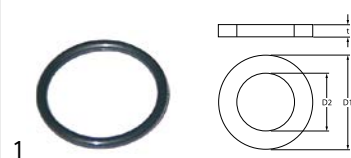
	Part No. 510072	Ref. No. 139321-192
	description O-ring EPDM thickness 3.53mm ID ø 32.93mm Qty 1 pcs	

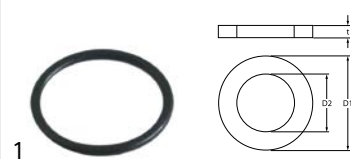
	Part No. 506015	Ref. No. 139321-738 371450-64 456052
	description O-ring EPDM thickness 3.53mm ID ø 39.69mm Qty 1 pcs	
For models: CLG-25-NA, ECOMAX-400S-12, GF-60, GF-60S		

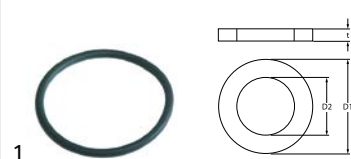
	Part No. 505180	Ref. No. 00-233982-001 00-276903-021 233982-1 276903-21
	description O-ring EPDM thickness 3.53mm ID ø 47.22mm Qty 1 pcs	
For models: CO-0611E, CO-1011E, CO-2011E, CS-0611E, CS-0612E-A, CS-1011E, CS-1012E-A, CS-1022E-A, CS-2011E, CS-2012E-A, CS-2022E-A, CSD-0611E, CSD-0612E-A, CSD-1011E, CSD-1012E-A, CSD-1022E-A, CSD-2011E, CSD-2012E-A, CSD-2022E-A, FX, GX, HX, HX-30, HX-30E, HX-30ES, HX-30S, HX-40, HX-40E, HX-40ES, HX-40S, HX-E, HX-ES, HX-S		

	Part No. 532118	Ref. No. RTCU700565
	description O-ring EPDM thickness 3.53mm ID ø 55.56mm Qty 10 pcs	



Part No.	532603	Ref. No.	139321-1041
description	O-ring EPDM thickness 3.53mm ID ø 69.85mm Qty 1 pcs		

Part No.	518113	Ref. No.	00-276903-017 276903-17
description	O-ring EPDM thickness 3mm ID ø 46mm Qty 1 pcs		
For models:	FE-W, FX, GX, HX, HX-30, HX-30E, HX-30ES, HX-30S, HX-40, HX-40E, HX-40ES, HX-40S, HX-60-EHL, HX-E, HX-ES, HX-S		

Part No.	532664	Ref. No.	276903-18
description	O-ring EPDM thickness 3.5mm ID ø 103mm Qty 1 pcs		
For models:	FE-W, FX, GX, HX, HX-30, HX-30E, HX-30ES, HX-30S, HX-40, HX-40E, HX-40ES, HX-40S, HX-60-EHL, HX-E, HX-ES, HX-S		

Part No.	510427	Ref. No.	775465-11
description	O-ring EPDM thickness 3mm ID ø 83mm Qty 1 pcs		
For models:	AM900, AMS900, FX, GC, GC31, GC32, GC41, GC42, GX		

Part No.	532667	Ref. No.	276903-26
description	O-ring EPDM thickness 3.5mm ID ø 14mm Qty 1 pcs		
For models:	AM-700, AM900, AMS900, AMX, AMX-900, AMX-E, AMX-ER, AMX-R, AMXR-900, AMXS-900, AMXX-1300, AMXXR-1300, AMXXS-1300, AMXXT, AUX, AUX_, AUX-E, AUX-ER, AUX-R, AUXX-1300, AUXXL, AUXXR-1300, AUXXS-1300, AUXXT, ECOMAX-600, ECOMAX-650, HE, HE600-HL, HE-P, HX, HX-30, HX-30E, HX-30ES, HX-30S, HX-40, HX-40E, HX-40ES, HX-40S, HX-60-EHL, HX-E, HX-ES, HX-S, UX-30, UX-30B, UX-30E, UX-30EB, UX-30EH, UX-30ES, UX-30ESB, UX-30ESH...(Other models you can see in the webshop)		

Part No.	502076	Ref. No.	00-276903-002 276903-2
description	O-ring EPDM thickness 4mm ID ø 12mm Qty 1 pcs		
For models:	AM-600, AM-600C, AM-600CR, AM-600R, UW-105, UW-135, UW-135H		

Part No.	510419	Ref. No.	00-276903-019 276903-19
description	O-ring EPDM thickness 3mm ID ø 150mm Qty 1 pcs		
For models:	FE-W, FX, GX, HX, HX-30, HX-30E, HX-30ES, HX-30S, HX-40, HX-40E, HX-40ES, HX-40S, HX-60-EHL, HX-E, HX-ES, HX-S		

Part No.	521035	Ref. No.	00-276903-028 276903-28
description	O-ring EPDM thickness 4mm ID ø 137mm Qty 1 pcs		
For models:	AM-10, AM-11, AM-141, AM-700, AM900, AM900-10N, AM900-90, AMS900, AMS900-10N, AMX, AMX-10HL, AMX-90, AMX-900, AMX-E, AMX-ER, AMXR, AMX-R, AMXR-900, AMXS, AMXS-900, AMXT, AMXTS, AMXX, AMXX-1300, AMXXR, AMXXR-1300, AMXXS, AMXXS-1300, AMXXT, AUP, AUP-90, AUPS, AUX, AUX_, AUX-E, AUX-ER, AUX-R, AUXX, AUXX-1300, AUXXL, AUXXL-11N, AUXXLS-11N, AUXXR, AUXXR-1300, AUXXS, AUXXS-1300, AUXXT, AUXXTS, CN, CNA...(Other models you can see in the webshop)		

Part No.	510563	Ref. No.	276903-9
description	O-ring EPDM thickness 3mm ID ø 28mm Qty 1 pcs		
For models:	AM-12E, AM-12EC, AM-12EF, AM-12ER, FUX, UW-100, UW-105, UW-120, UW-125, UW-135, UW-135H, UW-200, UW-205		

Part No.	532663	Ref. No.	276903-27
description	O-ring EPDM thickness 4mm ID ø 305mm Qty 1 pcs		
For models:	AMX, AMX-E, AMX-ER, AMX-R, AUX, AUX_, AUX-E, AUX-ER, AUX-R, CN, CNA, CNB, CNR, CR, CR-F, CSA, ECOMAX-800, FTN, UX-30, UX-30B, UX-30E, UX-30EB, UX-30ESB, UX-30ES, UX-30S, UX-30SB, UX-60, UX-60B, UX-60E, UX-60EB		

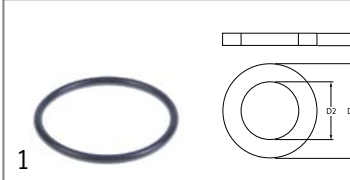
Part No.	521033	Ref. No.	00-276903-029 276903-29
description	O-ring EPDM thickness 4mm ID \varnothing 50mm Qty 1 pcs		
For models:	AM-10, AM-11, AM-141, AM900-10N, AM900-90, AMS900-10N, AMX, AMX-10HL, AMX-90, AMX-E, AMX-ER, AMXR, AMX-R, AMXS, AMXT, AMXTS, AMXX, AMXX-1300, AMXXR, AMXXR-1300, AMXXS, AMXXS-1300, AMXXT, AUP, AUP-90, AUPS, AUX, AUX_, AUX-E, AUX-ER, AUX-R, AUXX, AUXX-1300, AUXXL, AUXXL-11N, AUXXLS-11N, AUXXR, AUXXR-1300, AUXXS, AUXXS-1300, AUXXT, AUXXTS, ECOMAX-602-10, ECOMAX-602-11, ECOMAX-602S-11, ECOMAX-612-10, ECOMAX-612S-10, UX-30, UX-30B, UX-30E...(Other models you can see in the webshop)		

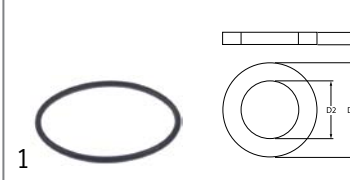

Part No.	502250	Ref. No.	00-276903-031 276903-31
description	O-ring EPDM thickness 4mm ID \varnothing 74mm Qty 1 pcs		
For models:	AMX, AMX-E, AMX-ER, AMX-R, AUX, AUX_, AUX-E, AUX-ER, AUX-R, CN, CNA, CNB, CNR, CR, CR-F, CSA, ECOMAX-800, ECW, FTN, UX-30, UX-30B, UX-30E, UX-30EB, UX-30EH, UX-30ES, UX-30ESB, UX-30ESH, UX-30H, UX-30-McDonalds, UX-30S, UX-30SB, UX-30SH, UX-60, UX-60B, UX-60E, UX-60EB, UX-60EH, UX-60EHB, UX-60H, UX-60HB, UXD-30		

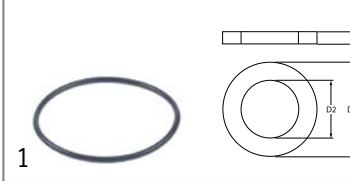

Part No.	532666	Ref. No.	276903-10
description	O-ring EPDM thickness 4mm ID \varnothing 75mm Qty 1 pcs		
For models:	AM-12E, AM-12EC, AM-12EF, AM-12ER, AM-600, AM-600C, AM-600CR, AM-600R, UW-100, UW-105		

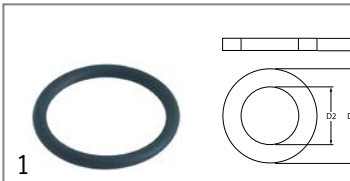

Part No.	505092	Ref. No.	233982-6
description	O-ring EPDM thickness 5.34mm ID \varnothing 43.82mm Qty 1 pcs		
For models:	CS-0612E-A, CS-1012E-A, CS-2012E-A, CSD-0612E-A, CSD-1012E-A, CSD-2012E-A		

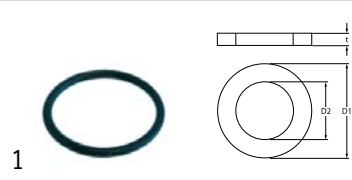

Part No.	510409	Ref. No.	00-276903-053 00-67500-016 00-67500-118 276903-53 670500-118 67500-16
description	O-ring EPDM thickness 5.34mm ID \varnothing 56.52mm Qty 1 pcs		
For models:	CR-F, CX, ECW, EWB-S, FTN, FTT, FTX, FUX, ML-104674, ML-104683, ML-104686, UW-135, UW-135H, UWX, UX-60, UX-60B, UX-60E, UX-60EB, UX-60EH, UX-60EHB, UX-60H, UX-60HB, UXT, UXTH, UXTHL, UXTHLS, UXTHS, UXTL, UXTLH, UXTLHS, UXTLS, UXTS, V1401		

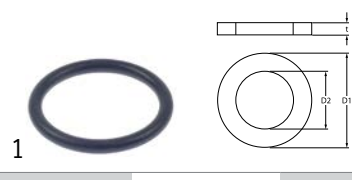

Part No.	532665	Ref. No.	139321-37 456002
description	O-ring EPDM thickness 6mm ID \varnothing 48mm Qty 1 pcs		
For models:	CHH-70D, ECOMAX-500, ECOMAX-601, EH-70, GE-400, GF-60, GF-60S, GW-600, GW-600S, GW-601, GW-601S, H-60, H66		

Viton

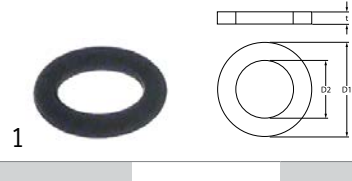

Part No.	521034	Ref. No.	00-276903-055 276903-55
description	O-ring Viton thickness 1.5mm ID \varnothing 6mm Qty 1 pcs		
For models:	AM-10, AM-11, AM-141, AM900-10N, AM900-90, AMS900-10N, AMX, AMX-10HL, AMX-90, AMXR, AMXS, AMXT, AMXTS, AMXX, AMXXR, AMXXS, AUP, AUP-90, AUPS, AUX, AUXXL-11N, AUXXLS-11N, AUXXR, AUXXS, AUXXT, AUXXTS, ECOMAX-602-10, ECOMAX-602-11, ECOMAX-602S-11, ECOMAX-612-10, ECOMAX-612S-10		

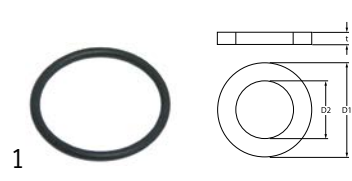

Part No.	521031	Ref. No.	00-276903-050 276903-50
description	O-ring Viton thickness 2mm ID \varnothing 24mm Qty 1 pcs		
For models:	AMX, AMX-10HL, AMX-90, AMXR, AMXS, AMXT, AMXTS, AMXX, AMXXR, AMXXS, AUP, AUP-90, AUPS, AUX, AUXXL-11N, AUXXLS-11N, AUXXR, AUXXS, AUXXT, AUXXTS, ECOMAX-402, ECOMAX-502, ECOMAX-602-11, ECOMAX-602S-11, ECOMAX-612-10, ECOMAX-612S-10, FP, FX, FX-McDonalds, GP, GX		





Part No.	521032	Ref. No.	00-276903-056 276903-56
description	O-ring Viton thickness 3mm ID \varnothing 25mm Qty 1 pcs		
For models:	AM-10, AM-11, AM-141, AM900-10N, AM900-90, AMS900-10N, AMX, AMX-10HL, AMX-90, AMXR, AMXS, AMXT, AMXTS, AMXX, AMXXR, AMXXS, AUP, AUP-90, AUPS, AUXX, AUXXL-11N, AUXXLS-11N, AUXXR, AUXXS, AUXXT, AUXXTS, CP-Protronic, ECOMAX-602-10, ECOMAX-602-11, ECOMAX-602S-11, ECOMAX-612-10, ECOMAX-612S-10		



Part No.	521030	Ref. No.	01-240135-011 01-240135-11
description	O-ring Viton thickness 5.34mm ID \varnothing 47mm Qty 1 pcs		
For models:	AM-10, AM-11, AM-141, AM900-10N, AM900-90, AMS900-10N, AMX, AMX-10HL, AMX-90, AMXR, AMXS, AMXT, AMXTS, AMXX, AMXXR, AMXXS, AUP, AUP-90, AUPS, AUXX, AUXXL-11N, AUXXLS-11N, AUXXR, AUXXS, AUXXT, AUXXTS, ECOMAX-402, ECOMAX-502, ECOMAX-602-10, ECOMAX-602-11, ECOMAX-602S-11, ECOMAX-612-10, ECOMAX-612S-10, FP, FX, FX-McDonalds, GP, GX		

miscellaneous



Part No.	510149	Ref. No.	226988
description	O-ring rubber thickness 6.3mm ID \varnothing 45mm Qty 1 pcs		
For models:	AM-12E, AM-12EC, AM-12EF, AM-12ER, AM-600, AM-600C, AM-600CR, AM-600R, UW-100, UW-105, UW-135, UW-135H		

sealing washers

fibre gaskets



Part No.	529349	Ref. No.	139321-21
description	flat gasket FIBER ED \varnothing 22mm ID \varnothing 16.5mm thickness 2mm for thread 3/8" Qty 1 pcs		
For models:	GE-400, GW-600, GW-600S, GW-601, GW-601S		



Part No.	518393	Ref. No.	139321-173
description	flat gasket FIBER ED \varnothing 24mm ID \varnothing 17mm thickness 2mm Qty 1 pcs		
For models:	GF-60S, GW-600, GW-600S, GW-601, GW-601S		



Part No.	524900	Ref. No.	168611-3 300084-1
description	flat gasket FIBER ED \varnothing 30mm ID \varnothing 21mm thickness 1.6mm Qty 1 pcs		
For models:	201G, 301G, AM-12E, AM-12EC, AM-12EF, AM-12ER, AM-600, AM-600C, AM-600CR, AM-600R, CM1E, CN, CNA, CNB, CNR, CO-2011E, CR, CR-F, CS-2011E, CSA, CSD-2011E, ECOMAX-800, FE-W, FTN, FTT, FTX, FX, GX, HX, HX-30, HX-30E, HX-30ES, HX-30S, HX-40, HX-40E, HX-40ES, HX-40S, HX-60-EHL, HX-E, HX-ES, HX-S, UW-105, UW-120, UW-125, UW-135, UW-135H, UW-200, UW-205, UW-X, UX-60...(Other models you can see in the webshop)		



Part No.	524898	Ref. No.	168611-11
description	flat gasket FIBER ED \varnothing 35mm ID \varnothing 22mm thickness 2mm Qty 1 pcs		
For models:	AMX-ER, AMX-R, AUX-ER, AUX-R, CN, CNB, CX, ECW, UW-120, UW-125, UW-200, UW-205, UW-X		



Part No.	510074	Ref. No.	139321-653
description	flat gasket FIBER ED \varnothing 35mm ID \varnothing 27mm thickness 1.5mm Qty 1 pcs		

rubber gaskets

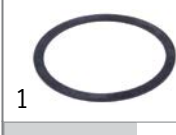



Part No.	517403	Ref. No.	00-172986-035 172986-35
description	flat gasket EPDM ED \varnothing 71mm ID \varnothing 61mm thickness 1.5mm Qty 1 pcs		
For models:	AM-10, AM-11, AM-141, AM900-10N, AM900-90, AMS900-10N, AMX, AMX-10HL, AMX-90, AMXR, AMXS, AMXT, AMXTS, AMXX, AMXXR, AMXXS, AUP, AUP-90, AUPS, AUXX, AUXXL-11N, AUXXLS-11N, AUXXR, AUXXS, AUXXT, AUXXTS, ECOMAX-602-10, ECOMAX-602-11, ECOMAX-602S-11, ECOMAX-612-10, ECOMAX-612S-10		





			
1			
Part No.	511657	Ref. No.	324594
description	flat gasket rubber ED ø 12mm ID ø 6.3mm thickness 2.5mm for wash pipe Qty 1 pcs suitable for HOBART		
For models:	AM-700, AM900, AMS900, AMX, AMX-900, AMX-E, AMX-ER, AMX-R, AMXR-900, AMXS-900, AMXX-1300, AMXXR-1300, AMXXS-1300, AMXXT, AUX, AUX_, AUX-E, AUX-ER, AUX-R, AUXX-1300, AUXXL, AUXXR-1300, AUXXS-1300, AUXXT, ECOMAX-600, ECOMAX-650, HX, HX-30, HX-30E, HX-30ES, HX-30S, HX-40, HX-40E, HX-40ES, HX-40S, HX-60-EHL, HX-E, HX-ES, HX-S, UX-30, UX-30B, UX-30E, UX-30EB, UX-30EH, UX-30ES, UX-30ESB, UX-30ESH, UX-30H, UX-30-McDonalds, UX-30S...(Other models you can see in the webshop)		

			
2			
Part No.	511656	Ref. No.	00-172986-018 172986-18
description	flat gasket rubber ED ø 13mm ID ø 7.5mm thickness 0.5mm Qty 1 pcs		
For models:	CX, FM-400H, FM-400U, FM-500, FM-500H, FTT, UW-105, UW-120, UW-125, UW-135, UW-135H, UW-200, UW-205, UW-55, UWX		

			
1			
Part No.	519547	Ref. No.	139321-657
description	flat gasket rubber ED ø 14.4mm ID ø 15.5mm thickness 2mm Qty 1 pcs size 3/4"		

			
1			
Part No.	524055	Ref. No.	229323
description	flat gasket rubber ED ø 18mm ID ø 12mm thickness 2mm Qty 1 pcs		
For models:	CX, UWX		

			
1			
Part No.	510075	Ref. No.	139321-725
description	flat gasket rubber ED ø 22mm ID ø 13mm thickness 1.5mm Qty 1 pcs		

			
1			
Part No.	505397	Ref. No.	437083
description	flat gasket rubber ED ø 32mm ID ø 19.5mm thickness 1.5mm Qty 1 pcs		
For models:	H-60		

			
1			
Part No.	518240	Ref. No.	139321-780
description	flat gasket rubber ED ø 33mm ID ø 17mm thickness 1.5mm Qty 1 pcs		

			
1			
Part No.	519119	Ref. No.	00-172986-026 172986-26
description	flat gasket rubber ED ø 58mm ID ø 42mm thickness 3mm Qty 1 pcs		
For models:	CN, CNA, CNB, CNR, CR, CR-F, CSA, ECOMAX-800, ECW, FTN		

			
1			
Part No.	524881	Ref. No.	172 986-33
description	flat gasket rubber ED ø 60mm ID ø 48mm thickness 3mm Qty 1 pcs		
For models:	AM-700, AM900, AMS900, AMX-900, AMXR-900, AMXS-900, ECOMAX-600		

			
1			
Part No.	518205	Ref. No.	139321-907
description	flat gasket rubber ED ø 61mm ID ø 47mm thickness 2mm Qty 1 pcs		

			
1			
Part No.	511962	Ref. No.	172986-15
description	flat gasket rubber ED ø 62mm ID ø 44mm thickness 0.9mm Qty 1 pcs		
For models:	AM-600, AM-600C, AM-600CR, AM-600R, FM-400H, FM-400U, FM-500, FM-500H, FTX, FUX, UW-105, UW-120, UW-135, UW-135H, UW-200, UW-55, UWX		

			
1			
Part No.	511651	Ref. No.	00-172986-022 172986-22
description	flat gasket rubber ED ø 71mm ID ø 59mm thickness 2mm for wash arm support Qty 1 pcs		
For models:	AMX, AMX-E, AMX-ER, AMX-R, AMXX-1300, AMXXR-1300, AMXXS-1300, AMXXT, AUX, AUX_, AUX-E, AUX-ER, AUX-R, AUXX-1300, AUXXL, AUXXR-1300, AUXXS-1300, AUXXT, CR, ECOMAX-700, UX, UX-30, UX-30B, UX-30E, UX-30EB, UX-30EH, UX-30ES, UX-30ESB, UX-30ESH, UX-30H, UX-30-McDonalds, UX-30S, UX-30SB, UX-30SH, UX-60, UX-60B, UX-60E, UX-60EB, UX-60EH, UX-60EHB, UX-60H, UX-60HB, UXD-30, UXL, UXLS, UXS, UXT, UXTH, UXTHL, UXTHLS...(Other models you can see in the webshop)		





			
1			
Part No.	510071	Ref. No.	139321-597
description	flat gasket rubber ED ø 81mm ID ø 68mm thickness 3mm for salt tank Qty 1 pcs		

			
1			
Part No.	507495	Ref. No.	00-775305-001 172513 775305-1
description	gasket ED ø 34mm ID ø 25.5mm thickness 2.5mm Qty 1 pcs		
For models:	AM-10, AM-11, AM-141, AM-700, AM900, AM900-10N, AM900-90, AMS900, AMS900-10N, AMX, AMX-10HL, AMX-90, AMX-900, AMX-E, AMX-ER, AMXR, AMX-R, AMXR-900, AMXS, AMXS-900, AMXT, AMXTS, AMXX, AMXX-1300, AMXXR, AMXXR-1300, AMXXS, AMXXS-1300, AMXXT, AUP, AUP-90, AUPS, AUX, AUX_, AUX-E, AUX-ER, AUX-R, AUXX, AUXX-1300, AUXXL, AUXXL-11N, AUXXLS-11N, AUXXR, AUXXR-1300, AUXXS, AUXXS-1300, AUXXT, AUXXTS, CM1E, CNA... (Other models you can see in the webshop)		

			
1			
Part No.	518060	Ref. No.	139321-913
description	gasket rubber ED ø 132mm ID ø 122mm thickness 5mm		
For models:	CHH-50, CHH-60D, CHH-70D, EH-60, EH-70		

<h3>plastic gaskets</h3> 			
1			
Part No.	511963	Ref. No.	119038-1
description	flat gasket plastic ED ø 175mm ID ø 136mm thickness 0.125mm for flange Qty 1 pcs		
For models:	AM-12E, AM-12EC, AM-12EF, AM-12ER, AM-600, AM-600C, AM-600CR, AM-600R, UW-100, UW-105		

			
1			
Part No.	510633	Ref. No.	324521
description	gasket foamed ED ø 93mm ID ø 85mm thickness 3mm Qty 1 pcs		
For models:	FX, GX, HX-30ES, HX-30S, HX-40ES, HX-40S, HX-ES, HX-S, UX-30ES, UX-30ESB, UX-30ESH, UX-30-McDonalds, UX-30S, UX-30SB, UX-30SH		

<h3>copper gaskets</h3>			
<h4>DIN-7603-A</h4>			
			
1			
Part No.	560508	Ref. No.	WA-E-5-29
description	flat gasket copper ED ø 16mm ID ø 8.3mm thickness 1mm Qty 1 pcs		
For models:	104G, 201G, 204G, 301G, 304G, GF-120, UW-100, UW-120, UW-125, UW-200, UW-205		

<h3>PTFE gaskets</h3>			
			
1			
Part No.	518346	Ref. No.	437090
description	flat gasket PTFE ED ø 22mm ID ø 9.2mm thickness 1mm Qty 1 pcs equiv. no. 437090 suitable for COLGED		
For models:	H-60		

			
1			
Part No.	518180	Ref. No.	303018
description	flat gasket PTFE ED ø 40mm ID ø 35mm thickness 3mm Qty 1 pcs equiv. no. 303018/371450-166 suitable for COLGED, HOBART		
For models:	CLG-25, CLG-25-NA, ECOMAX-400-12, ECOMAX-400S-12		

			
1			
Part No.	518119	Ref. No.	00-774072-001 774072-1
description	slide ring PTFE ED ø 19mm ID ø 14.5mm thickness 0.5mm for rinse arm Qty 1 pcs suitable for HOBART		
For models:	AM-10, AM-11, AM-141, AM-700, AM900, AM900-10N, AM900-90, AMS900, AMS900-10N, AMX, AMX-10HL, AMX-90, AMX-900, AMX-E, AMX-ER, AMXR, AMX-R, AMXR-900, AMXS, AMXS-900, AMXT, AMXTS, AMXX, AMXX-1300, AMXXR, AMXXR-1300, AMXXS, AMXXS-1300, AMXXT, AUP, AUP-90, AUPS, AUX, AUX_, AUX-E, AUX-ER, AUX-R, AUXX, AUXX-1300, AUXXL, AUXXL-11N, AUXXLS-11N, AUXXR, AUXXR-1300, AUXXS, AUXXS-1300, AUXXT, AUXXTS, ECOMAX-402, ECOMAX-502... (Other models you can see in the webshop)		

			
1			
Part No.	518120	Ref. No.	00-774072-002 774072-2
description	slide ring PTFE ED ø 21mm ID ø 16mm thickness 0.5mm for rinse arm Qty 1 pcs		
For models:	AM-10, AM-11, AM-141, AM-700, AM900, AM900-10N, AM900-90, AMS900, AMS900-10N, AMX, AMX-10HL, AMX-90, AMX-900, AMX-E, AMX-ER, AMXR, AMX-R, AMXR-900, AMXS, AMXS-900, AMXT, AMXTS, AMXX, AMXX-1300, AMXXR, AMXXR-1300, AMXXS, AMXXS-1300, AMXXT, AUP, AUP-90, AUPS, AUX, AUX_, AUX-E, AUX-ER, AUX-R, AUXX, AUXX-1300, AUXXL, AUXXL-11N, AUXXLS-11N, AUXXR, AUXXR-1300, AUXXS, AUXXS-1300, AUXXT, AUXXTS, ECOMAX-402, ECOMAX-502... (Other models you can see in the webshop)		



			
1			
Part No.	511678	Ref. No.	00-774072-007 774072-7
description	slide ring PTFE ED ø 24mm ID ø 13mm thickness 1mm for rinse arm Qty 1 pcs		
For models:	AM-10, AM-11, AM-141, AMX, AMX-10HL, AMX-90, AMXR, AMXS, AMXX, AMXXR, AMXXS, AUP, AUP-90, AUPS, AUXX, AUXXR, AUXXS, ECOMAX-402, ECOMAX-502, ECOMAX-602-10, ECOMAX-602-11, ECOMAX-602S-11, ECOMAX-612-10, ECOMAX-612S-10, FP, FX, FX- Mc-Donalds, GP, GX		

shaft gaskets

shaft gaskets

			
1			
Part No.	698317	Ref. No.	OS-E-2-50
description	shaft seal ID ø 25mm ED ø 32mm thickness 4mm		

miscellaneous

			
1			
Part No.	511605	Ref. No.	322190-1
description	shaft seal		
For models:	CO-0611E, CO-1011E, CO-2011E, CS-0611E, CS-0612E-A, CS-1011E, CS-1012E-A, CS-1022E-A, CS-2011E, CS-2012E-A, CS-2022E-A, CSD-0611E, CSD-0612E-A, CSD-0612ET, CSD-1011E, CSD-1012E-A, CSD-1012ET, CSD-1022E-A, CSD-2011E, CSD-2012E-A, CSD-2012ET, CSD-2022E-A		

special gaskets

door seals for dishwashers

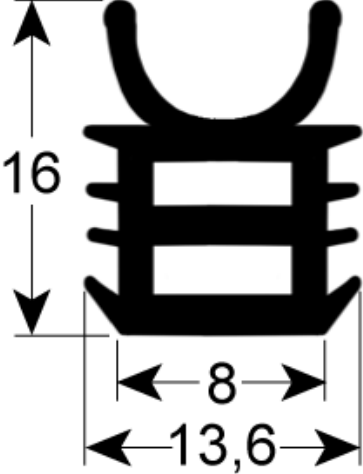
			
1			
Part No.	518182	Ref. No.	01-240077-001 01-240077-1
description	door seal L 564mm W 493mm Qty 1 for dishwasher 3-sided suitable for HOBART		
For models:	FP, FX, FX-McDonalds, GP, GX		

			
1			
Part No.	518614	Ref. No.	774063-1
description	door seal L 565mm W 427mm mounting pos. upper for dishwasher 3-sided		
For models:	FE, FE-W		

miscellaneous

			
1			
Part No.	511600	Ref. No.	844617
description	gasket ED ø 80mm		
For models:	CS-0612E, CS-0612E-A, CS-1012E, CS-1012E-A, CS-1012G, CS-1022E, CS-1022E-A, CS-2012E, CS-2012E-A, CS-2012G, CS-2022E, CS-2022E-A, CSD-0612E, CSD-0612E-A, CSD-1012E, CSD-1012E-A, CSD-1013G, CSD-1022E, CSD-1022E-A, CSD-2012E, CSD-2012E-A, CSD-2013G, CSD-2022E, CSD-2022E-A, CSL-06E, CSL-10E, CSM-0611IE, CSM-0611N, CSM-1011IE, CSM-1011N, CSM-1021IE, CSM-1021N, CSM-2011IE, CSM-2011N, CSM-2021IE, CSM-2021N		



			
1			
Part No.	524926	Ref. No.	323930-1
description	gasket for bearing ID ø 12mm H 23mm L 30mm W 12mm mounting pos. left		
For models:	FE, FE-W		

			
1			
Part No.	524925	Ref. No.	323930-2
description	gasket for bearing ID ø 12mm H 23mm L 30mm W 12mm mounting pos. right		
For models:	FE, FE-W		

			
1			
Part No.	524906	Ref. No.	323785-101
description	gasket for drain assembly ø 14mm		
For models:	FX, GX		

			
1			
Part No.	524899	Ref. No.	371450-47
description	gasket for in-line particle filter L 71mm W 38mm thickness 1mm rubber hole distance 59mm		
For models:	GF-60, GF-60S		

			
1			
Part No.	524903	Ref. No.	119054
description	gasket L 147mm W 89mm for pump casing rubber ø 70mm H 2mm		
For models:	AM-12E, AM-12EC, AM-12EF, AM-12ER		

			
1			
Part No.	524902	Ref. No.	119051
description	gasket L 58mm W 26mm for pump casing FIBER H 2mm		
For models:	AM-12E, AM-12EC, AM-12EF, AM-12ER, AM-600, AM-600C, AM-600CR, AM-600R, UW-100, UW-105		

			
1			
Part No.	524904	Ref. No.	296709
description	gasket L 99mm W 78mm for pump casing rubber H 6mm		
For models:	ACW, CX, FTT, FTX, FUX, UW-135, UW-135H, UWX		

			
1			
Part No.	511938	Ref. No.	226556
description	gasket suitable for HOBART external height 10mm ED ø 70mm ID ø 45mm for outflow		
For models:	ACW, AM-12E, AM-12EC, AM-12EF, AM-12ER, CX, ECW, FM-30, FM-30U, FTT, FTX, FUX, UW-100, UWX		

			
1			
Part No.	524687	Ref. No.	140300 227752
description	gasket suitable for HOBART for dosing pump L 60mm W 48mm thickness 1.55mm hole distance 48mm		
For models:	CM1E, FX, GX, WM2E		

gaskets for wash arm support

			
1			
Part No.	518025	Ref. No.	139321-840
description	gasket D1 ø 50mm D2 ø 82mm thickness 2mm with 6 holes wash arm support equiv. no. 437014 suitable for COLGED		

			
1			
Part No.	518339	Ref. No.	139321-864
description	gasket D2 ø 50mm thickness 2mm with 3 screw holes wash arm support equiv. no. 437064 suitable for COLGED hole ø 50mm hole distance 67mm		



evaporators

for fridges

producer-specific



1

Part No.	750504	Ref. No.	15463031 F15463031
description	evaporator L 700mm W 250mm H 190mm suitable for FOSTER		

transmission technology and ball bearings

drive belts

poly-v belts

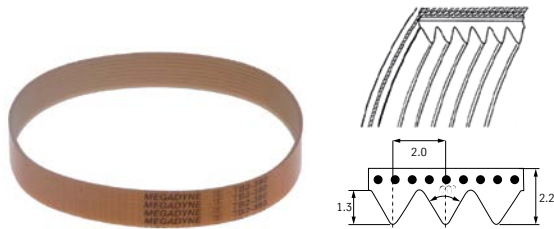

1

Part No.	697617	Ref. No.	00-479391
description	poly-v belt grooves 10 W 20mm L 360mm profile TB2		

springs

compression springs



1

Part No.	511966	Ref. No.	119229
description	compression spring \varnothing 23mm L 22mm wire gauge \varnothing 1.5mm		
For models:	AM-12E, AM-12EC, AM-12EF, AM-12ER, AM-600, AM-600C, AM-600CR, AM-600R, UW-100, UW-105, UW-120, UW-125, UW-135, UW-135H, UW-200, UW-205		



1

Part No.	519539	Ref. No.	12757-E
description	compression spring \varnothing 36mm wire gauge \varnothing 3.5mm windings 3 for mixer		

spring compressors



1

Part No.	513119	Ref. No.	139321-678
description	spring compressor		

gas tension springs

gas tension springs



1

Part No.	701241	Ref. No.	01-240229-001 01-240229-1
description	gas tension spring 50N hub 205mm D1 \varnothing 15mm D2 \varnothing 6mm hole distance 425mm hole \varnothing 5/6mm L 433mm		
For models:	FP, FX, FX-McDonalds, GP, GX		

roller springs

roller springs



1

Part No.	519618	Ref. No.	01-245278-6
description	roller spring 0.53kg W 55mm ID \varnothing 10.5mm lug length 28mm		



1

Part No.	519514	Ref. No.	774749-5
description	roller spring complete W 40mm ID \varnothing 10.5mm lug length 49mm		
For models:	CN, CNA, CNB, CNR, CR, FTN		



1

Part No.	519492	Ref. No.	774749-2
description	roller spring complete W 40mm ID \varnothing 10.5mm lug length 54mm		
For models:	CN, CNA, CNB, CNR, CR, CR-F, FTN		



1

Part No.	519496	Ref. No.	774749-6
description	roller spring W 40mm ID ø 10.5mm lug length 52mm		
For models:	CN, CNA, CNB, CNR, CR, FTN		



1

Part No.	517409	Ref. No.	774749-3
description	roller spring W 40mm ID ø 10.5mm lug length 54mm		
For models:	CSA, FTN		



1

Part No.	519515	Ref. No.	229277
description	roller spring W 40mm ID ø 35mm lug length 23mm		
For models:	CX, FTT, FTX, FUX		



1

Part No.	520590	Ref. No.	01-245278-7
description	roller spring W 55mm ID ø 11mm lug length 30mm		



1

Part No.	694272	Ref. No.	299110 378591
description	roller spring W 65mm ID ø 48mm lug length 24mm		
For models:	UW-100, UW-105, UW-120, UW-125, UW-200, UW-205		

accessories

bolts



1

Part No.	694271	Ref. No.	602812
description	bolt ø 10mm L 95mm		
For models:	UW-105, UW-120, UW-125, UW-200, UW-205		

rollers



1

Part No.	694270	Ref. No.	299109
description	roller ø 43mm W 75mm		
For models:	UW-105, UW-120, UW-125, UW-200, UW-205		

tension springs



1

Part No.	511965	Ref. No.	119079-2
description	spring for hood mechanics wire gauge ø 5.5mm ø 50mm total length 385mm		
For models:	AM-12EC, AM-600C, AM-600CR, AMX, AMX-E, AMX-ER, AMX-R, AUX, AUX_, AUX-E, AUX-ER, AUX-R, FM-30, FM-400H, FM-500H, HE, HE600-HL, HE-P, HX, HX-30, HX-30E, HX-30ES, HX-30S, HX-40, HX-40E, HX-40ES, HX-40S, HX-60-EHL, HX-E, HX-ES, HX-S, UX-30EH, UX-30ESH, UX-30H, UX-30-McDonalds, UX-30SH		



1

Part No.	503504	Ref. No.	00-378622-001 378622-1
description	tension spring		
For models:	FX		



1

Part No.	518260	Ref. No.	371450-28
description	tension spring ø 10mm total length 145mm wire gauge ø 1mm		
For models:	GF-60, GF-60S		



1



Part No.	503503	Ref. No.	227855
description	tension spring ø 13mm total length 147mm wire gauge ø 1.5mm		
For models:	CM1E, FE, FE-W, FM-30U, FM-400U, FM-500, FX, GX, UW-55, WM2E		



Part No.	504424	Ref. No.	00-324773-000
description	tension spring ø 20mm total length 245mm wire gauge ø 2.5mm for door Qty 1 pcs		
For models:	UX-30, UX-30E, UX-30ES, UX-30-McDonalds, UX-30S, UX-60, UX-60E, UXD-30, UXL, UXLS		



Part No.	517448	Ref. No.	139321-666
description	tension spring ø 30mm total length 505mm wire gauge ø 5.5mm for hood mechanics Qty 1 pcs		

manometers



Part No.	542445	Ref. No.	229583-2
description	manometer ø 62mm pressure range 0-1.6bar connection 1/4"		



Part No.	541788	Ref. No.	229583-1
description	manometer ø 62mm pressure range 0-1bar connection 1/4"		
For models:	ACW, CNA, CNB, CNR, CR-F, CX, ECW, FTN, FTT, FTX, FUX, UWX		

dosing pumps

peristaltic dosing pumps

ASF/THOMAS

built-in version

without control



Part No.	361373	Ref. No.	228022-1
description	dosing pump detergent 230V		
For models:	AM-600, AM-600C, AM-600CR, AM-600R, CM1E, FM-400H, FM-400U, FM-500, FM-500H, UW-105, UW-135, UW-135H, UW-55, WM2E		

SAIER

built-in version

without control









Part No.	361835	Ref. No.	01-240195-002 01-240195-2 028999 AH98299-H0017-2
description	dosing pump without control 3l/h 230VAC detergent hose ø 6x4mm hose type Santoprene 4.9(5.4)W cable length 750mm built-in version counter pressure 0.1bar 50/60Hz		
For models:	FP, FX-McDonalds, GP		
spare parts for	361835		
	Part No.	361946	Ref. No. 01-240195-012 01-240195-12 01-515268-12 883860-12
service kit SAIER detergent hose type Santoprene hose ø 6x4mm incl. bracket			





spare parts			
			
1			
Part No.	361946	Ref. No.	01-240195-012 01-240195-12 01-515268-12 883860-12
description	service kit SAIER detergent hose type Santoprene hose ø 6x4mm incl. bracket		
For models:	FP, FX-McDonalds, GP		



			
2			
Part No.	361947	Ref. No.	01-240195-011 01-240195-11
description	service kit SAIER rinse aid hose type silicone hose ø 6x4mm incl. bracket		
For models:	FP, FX-McDonalds, GP		

SEKO			
built-in version			
without control			
			
1			
Part No.	361150 ¹	Ref. No.	00-775556-011 775556-11
description	dosing pump SEKO without control 0.4l/h 230VAC rinse aid hose ø 4x6mm hose type D hose Sekobril suction level 1.5m horizontal/vertical type PG dimensions 67x95x52mm		
For models:	ECOMAX-402, ECOMAX-502, FX, FX-McDonalds, GX		
spare parts for	361150		
			
Part No.	361135	Ref. No.	00-775608-001 775608-1
description	pump hose SEKO rinse aid hose ø 3x8mm hose ø 4x6mm hose type D hose Sekobril		
			
Part No.	361136	Ref. No.	—
description	roller assembly for dosing pump hole ø 4.8x4mm		
			
Part No.	361562	Ref. No.	—
description	pump cover for dosing pump yellow		
			
Part No.	361866	Ref. No.	00-775507-001 775507-1
description	union nut for hose connector ø 17mm		
accessories for	361150		
			
Part No.	361144	Ref. No.	—
description	mounting set rinse aid hose type 4x6mm hose length 2m PVC/nylon hose container filter/non-return valve transparent		

¹with accessories

accessories for 361150			
			
Part No.	570123	Ref. No.	01-246301-001 01-246301-1
description	PVC hose ID ø 4mm ED ø 6mm L 3.5m thickness 1mm t.max. 60°C transparent		

			
1			
Part No.	361867	Ref. No.	00-883828-001 883828-1
description	dosing pump SEKO without control 0.4l/h 230VAC rinse aid hose ø 4x6mm hose type D hose Sekobril suction level 1.5m type NPG 0.4 8W cable length 45mm built-in version counter pressure 1bar		
For models:	AM-10, AM-11, AM-141, AM900-10N, AM900-90, AMS900-10N, AMX, AMX-10HL, AMX-90, AMXR, AMXS, AMXT, AMXTS, AMXX, AMXXR, AMXXS, AUXX, AUXXL-11N, AUXXLS-11N, AUXXR, AUXXS, AUXXT, AUXXTS, ECOMAX-602-10, ECOMAX-602-11, ECOMAX-602S-11, ECOMAX-612-10, ECOMAX-612S-10		
spare parts for	361867		
			
Part No.	361135	Ref. No.	00-775608-001 775608-1
description	pump hose SEKO rinse aid hose ø 3x8mm hose ø 4x6mm hose type D hose Sekobril		

			
1			
Part No.	361869	Ref. No.	00-883828-002 883828-2
description	dosing pump SEKO without control 3l/h 230VAC detergent hose ø 4x6mm hose type K hose Santoprene suction level 1.5m type NPG 3		
For models:	AM-11, AM900-10N, AM900-90, AMS900-10N, AMX, AMX-10HL, AMX-90, AMXR, AMXS, AMXT, AMXTS, AMXX, AMXXR, AMXXS, AUXX, AUXXL-11N, AUXXLS-11N, AUXXR, AUXXS, AUXXT, AUXXTS, ECOMAX-602-11, ECOMAX-602S-11, ECOMAX-612-10, ECOMAX-612S-10		
spare parts for	361869		
			
Part No.	361815	Ref. No.	00-775608-002 775608-2
description	pump hose detergent hose ø 6x10mm hose ø 4x6mm hose type K hose Santoprene type SEKO		

1

Part No.	361868	Ref. No.	00-775556-012 775556-12
description	dosing pump SEKO without control 3l/h 230VAC detergent hose ø 4x6mm hose type K hose Santoprene suction level 1.5m type PG 8W		
For models:	ECOMAX-402, ECOMAX-502, FX, FX-McDonalds, GX		
spare parts for	361868		
	Part No.	361815	Ref. No. 00-775608-002 775608-2
	pump hose detergent hose ø 6x10mm hose ø 4x6mm hose type K hose Santoprene type SEKO		



1

Part No.	361896	Ref. No.	775556-2 897931
description	dosing pump SEKO without control 3l/h 230VAC detergent hose ø 4x6mm hose type K hose Santoprene suction level 1.5m type PG 8W cable length 430mm built-in version kit CODE PPG0003A1024		
For models:	AM-700, AM900, AMS900, AMX-900, AMXR-900, AMXS-900, AMXX-1300, AMXXR-1300, AMXXS-1300, AMXXT, AUXX-1300, AUXXL, AUXXR-1300, AUXXS-1300, AUXXT, ECOMAX-600, ECOMAX-650, ECOMAX-700, FX, GC, GC11, GC12, GC31, GC32, GC41, GC42, GX, UX, UXL, UXLS, UXS, UXT, UXTH, UXTHL, UXTHLS, UXTHS, UXTL, UXTLH, UXTLHS, UXTLS, UXTS		

spare parts



1

Part No.	698712	Ref. No.	143258
description	dosing hose SEKO detergent hose ø 4x8.6mm hose ø 4x6mm hose type H hose Santoprene		



1

Part No.	362005	Ref. No.	00-775608-003 775608-3
description	dosing hose SEKO rinse aid hose ø 6.25x10.55mm hose length 135mm hose ø 4x6mm hose type M hose Sekobril		



1

Part No.	361815	Ref. No.	00-775608-002 775608-2
description	pump hose detergent hose ø 6x10mm hose ø 4x6mm hose type K hose Santoprene type SEKO		
For models:	AM-11, AM900-10N, AM900-90, AMS900-10N, AMX, AMX-10HL, AMX-90, AMXR, AMXS, AMXT, AMXTS, AMXX, AMXXR, AMXXS, AUXX, AUXXL-11N, AUXXLS-11N, AUXXR, AUXXS, AUXXT, AUXXTS, ECOMAX-402, ECOMAX-502, ECOMAX-602-11, ECOMAX-602S-11, ECOMAX-612-10, ECOMAX-612S-10, FX, FX-McDonalds, GX		



1

Part No.	361135	Ref. No.	00-775608-001 775608-1
description	pump hose SEKO rinse aid hose ø 3x8mm hose ø 4x6mm hose type D hose Sekobril		
For models:	AM-10, AM-11, AM-141, AM900-10N, AM900-90, AMS900-10N, AMX, AMX-10HL, AMX-90, AMXR, AMXS, AMXT, AMXTS, AMXX, AMXXR, AMXXS, AUXX, AUXXL-11N, AUXXLS-11N, AUXXR, AUXXS, AUXXT, AUXXTS, ECOMAX-402, ECOMAX-502, ECOMAX-602-10, ECOMAX-602-11, ECOMAX-602S-11, ECOMAX-612-10, ECOMAX-612S-10, FX, FX-McDonalds, GX		
spare parts for	361135		
	Part No.	361866	Ref. No. 00-775507-001 775507-1
	union nut for hose connector ø 17mm		

various
built-in version



1

Part No.	361828	Ref. No.	00-323772-002 00-324232-002 323772-2 324232-2
description	dosing pump HOBART 230VAC hose ø 6mm CODE C-323 772-2		
For models:	AMX, AMX-E, AMX-ER, AMX-R, AUX, AUX_, AUX-E, AUX-ER, AUX-R, FE-W, FX, GX, HX, HX-30, HX-30E, HX-30ES, HX-30S, HX-40, HX-40E, HX-40ES, HX-40S, HX-60-EHL, HX-E, HX-ES, HX-S, UX-30, UX-30B, UX-30E, UX-30EB, UX-30EH, UX-30ES, UX-30ESB, UX-30ESH, UX-30H, UX-30-McDonalds, UX-30S, UX-30SB, UX-30SH, UX-60, UX-60B, UX-60E, UX-60EB, UX-60EH, UX-60EHB, UX-60H, UX-60HB		
spare parts for	361828		
	Part No.	361832	Ref. No. 324356-2
	silicone hose rinse aid silicone beige		



piston pumps

dosing pumps



1			
Part No.	361838	Ref. No.	378625-1 378625-1P
description	dosing pump type TTE 200-240V detergent inlet 5.5mm outlet 5.5mm HOBART		
For models:	AMX, AMX-E, AMX-ER, AMX-R, AUX, AUX_, AUX-E, AUX-ER, AUX-R, FE-W, FX, GE-400, GF-60, GF-60S, GX, HX, HX-60-EHL, HX-E, HX-ES, HX-S, UX-30, UX-30B, UX-30E, UX-30EB, UX-30EH, UX-30ES, UX-30ESB, UX-30ESH, UX-30H, UX-30-McDonalds, UX-30S, UX-30SB, UX-30SH		





1			
Part No.	361895	Ref. No.	378625-1P + Zubeh+r 378630
description	dosing pump type TTE service kit 200-240V detergent inlet 5.5mm outlet 5.5mm		
For models:	FX, GX		
spare parts for	361895		
	Part No.	361838	Ref. No. 378625-1 378625-1P
	dosing pump type TTE 200-240V detergent inlet 5.5mm outlet 5.5mm HOBART		

membrane dosing pumps



electric dosing pumps

Delta



1			
Part No.	361023 ¹	Ref. No.	172927-1
description	dosing pump ASF/THOMAS 230V rinse aid/detergent duty cycle 100% type DELTA valve lips/SS valve		
For models:	AM-600, AM-600C, AM-600CR, AM-600R, UW-105, UW-135, UW-135H		
spare parts for	361023		
	Part No.	361122	Ref. No. —
	lip valve type DELTA		
	Part No.	361123	Ref. No. —
	membrane type DELTA		
	Part No.	361168	Ref. No. —
	valve type DELTA		











¹lip valve SS

spare parts for	361023		
	Part No.	361169	Ref. No. —
	hose connector type DELTA		
	Part No.	361188	Ref. No. —
	disc type DELTA		
	Part No.	361319	Ref. No. —
	flat gasket rubber ID ø 9mm ED ø 14.5mm thickness 1mm type DELTA		

self-priming

SEKO



1			
Part No.	361364 ¹	Ref. No.	139321-1120 139321-499
description	dosing pump type DIB5E self-sucking rinse aid pump rate 0-5cm ³ per stroke pressure connection ø 4x6mm suction connection ø 4x6mm SEKO supporting pressure closed		
For models:	CHF45, CLG-25, EF-40		
spare parts for	361364		
	Part No.	361301	Ref. No. —
	hose connector for type DIB3E/DIB5E		
	Part No.	361302	Ref. No. —
	valve bush for type DIB3E/DIB5E		
	Part No.	361304	Ref. No. —
	O-ring EPDM ID ø 11.11mm thickness 1.78mm Qty 1 pcs for type DIB3E/DIB5E		
	Part No.	361305	Ref. No. —
	valve disc for type DIB3E/DIB5E DIB3P/DIB5P		
	Part No.	361306	Ref. No. —
	membrane for type DIB3E/DIB5E ø 49mm hole ø 5mm		
	Part No.	361307	Ref. No. —
	membrane dosing pump ø 68mm hole ø 6mm for type DIB3P/DIB5P		
	Part No.	361459	Ref. No. —
	hose connector ø 6mm for dosing pump		
	Part No.	361481	Ref. No. —
	lip valve for type DIB3P/DIB5P DIB3E/DIB5E		
accessories for	361364		
	Part No.	361240	Ref. No. —
	hose connector 1-way hose ø 6mm plastic connection M10x1		
	Part No.	361241	Ref. No. —
	hose connector 1-way hose ø 9mm plastic connection M10x1		

¹auxiliary pressure connection closed



self-priming with supporting pressure

ELETTROBAR



1

Part No.	361362	Ref. No.	987023 E999266
description	dosing pump rinse aid pressure connection ø 6mm pressure connection 6		
For models:	CLG-25, CLG-25-NA, ECOMAX-400-12, ECOMAX-400S-12, ECOMAX-500, ECOMAX-601		
spare parts for	361362		
	Part No.	361363	Ref. No. —
	membrane		
	Part No.	510298	Ref. No. —
	lip valve dosing pump suitable for DB2/DS5		

SEKO



1

Part No.	361039	Ref. No.	139321-521 139321-931
description	dosing pump type DIB5P with auxiliary pressure connection rinse aid 0-5cm³ per stroke/h pressure connection ø 4x6mm suction connection ø 4x6mm auxiliary pressure connection 10mm SEKO		
For models:	CHH-70D, EH-70		
spare parts for	361039		
	Part No.	361301	Ref. No. —
	hose connector for type DIB3E/DIB5E		
	Part No.	361302	Ref. No. —
	valve bush for type DIB3E/DIB5E		
	Part No.	361304	Ref. No. —
	O-ring EPDM ID ø 11.11mm thickness 1.78mm Qty 1 pcs for type DIB3E/DIB5E		
	Part No.	361305	Ref. No. —
	valve disc for type DIB3E/DIB5E DIB3P/DIB5P		
	Part No.	361307	Ref. No. —
	membrane dosing pump ø 68mm hole ø 6mm for type DIB3P/DIB5P		
	Part No.	361481	Ref. No. —
	lip valve for type DIB3P/DIB5P DIB3E/DIB5E		

accessories



1

Part No.	361141	Ref. No.	139321-594
description	container filter with weight ceramic hose ø 4mm		



1

Part No.	518372	Ref. No.	00-775239-001 775239-1
description	container filter with weight ceramic hose ø 4mm		
For models:	AM-10, AM-11, AM-141, AM-700, AM900, AM900-10N, AM900-90, AMS900, AMS900-10N, AMX, AMX-10HL, AMX-90, AMX-900, AMXR, AMXR-900, AMXS, AMXS-900, AMXT, AMXTS, AMXX, AMXX-1300, AMXXR, AMXXR-1300, AMXXS, AMXXS-1300, AMXXT, AUP, AUP-90, AUPS, AUX, AUX-1300, AUXXL, AUXXL-11N, AUXXLS-11N, AUXXR, AUXXR-1300, AUXXS, AUXXS-1300, AUXXT, AUXXTS, ECOMAX-402, ECOMAX-502, ECOMAX-600, ECOMAX-602-10, ECOMAX-602-11, ECOMAX-602S-11, ECOMAX-612-10, ECOMAX-612S-10, ECOMAX-650, ECOMAX-700...(Other models you can see in the webshop)		

container filters with non-return valve



1

Part No.	361839	Ref. No.	227441-1
description	container filter with non-return valve SS hose ø 6mm ø 20mm L 55mm for dosing pump		
For models:	AM-12E, AM-12EC, AM-12EF, AM-12ER, AMX, AMX-E, AMX-ER, AMX-R, AUX, AUX-E, AUX-ER, AUX-R, ECOMAX-600, ECOMAX-700, ECW, FE, FEW, FX, GE-400, GX, HE, HE600-HL, HX, HX-60-EHL, HX-E, HX-ES, HX-S, UX-30, UX-30B, UX-30E, UX-30EB, UX-30EH, UX-30ES, UX-30ESB, UX-30ESH, UX-30H, UX-30-McDonalds, UX-30S, UX-30SB, UX-30SH, UX-60, UX-60B, UX-60E, UX-60EB, UX-60EH, UX-60EHB, UX-60H, UX-60HB		

hoses

PVC hoses





1

Part No.	570126	Ref. No.	01-246301-010 01-246301-10
description	PVC hose ID ø 4mm ED ø 6mm L 0.28m thickness 1mm t.max. 60°C transparent		
For models:	AMX, AMX-10HL, AMX-90, AMXR, AMXS, AMXX, AMXXR, AMXXS, AUP, AUP-90, AUPS, AUX, AUXXR, AUXXS, ECOMAX-402, ECOMAX-502		



			
Part No.	570124	Ref. No.	01-246301-008 01-246301-8
description	PVC hose ID ø 4mm ED ø 6mm L 0.5m thickness 1mm t.max. 60°C transparent		
For models:	AM-11, AM900-10N, AM900-90, AMS900-10N, AMX, AMX-10HL, AMX-90, AMXR, AMXS, AMXT, AMXTS, AMXX, AMXXR, AMXXS, AUP, AUP-90, AUPS, AUXX, AUXXL-11N, AUXXLS-11N, AUXXR, AUXXS, AUXXT, AUXXTS, ECOMAX-602-11, ECOMAX-602S-11, ECOMAX-612-10, ECOMAX-612S-10		

			
Part No.	570123	Ref. No.	01-246301-001 01-246301-1
description	PVC hose ID ø 4mm ED ø 6mm L 3.5m thickness 1mm t.max. 60°C transparent		
For models:	ECOMAX-402, ECOMAX-502, FP, FX, FX-McDonalds, GP, GX, UX, UXL, UXLS, UXS, UXT, UXTL, UXTLS, UXTS		

			
Part No.	520090	Ref. No.	00-898252-002 00-898252-005 898252-2 898252-5
description	PVC hose ID ø 4mm ED ø 6mm L 2m thickness 1mm t.max. 60°C transparent		
For models:	AM-10, AM-11, AM-141, AM-700, AM900, AM900-10N, AM900-90, AMS900, AMS900-10N, AMX, AMX-10HL, AMX-90, AMX-900, AMXR, AMXR-900, AMXS, AMXS-900, AMXT, AMXTS, AMXX, AMXX-1300, AMXXR, AMXXR-1300, AMXXS, AMXXS-1300, AMXXT, AUP, AUP-90, AUPS, AUXX, AUXX-1300, AUXXL, AUXXL-11N, AUXXLS-11N, AUXXR, AUXXR-1300, AUXXS, AUXXS-1300, AUXXT, AUXXTS, ECOMAX-600, ECOMAX-602-10, ECOMAX-602-11, ECOMAX-602S-11, ECOMAX-612-10, ECOMAX-612S-10, ECOMAX-650, ECOMAX-700, GC, GC11...(Other models you can see in the webshop)		

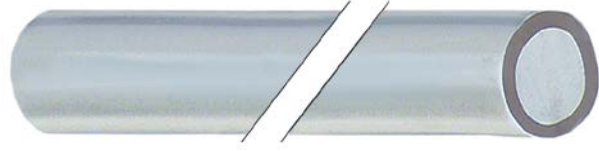
			
Part No.	570127	Ref. No.	01-246301-011 01-246301-11 01-515410-011
description	PVC hose ID ø 4mm ED ø 6mm L 4m thickness 1mm t.max. 60°C transparent		
For models:	AM-10, AM-11, AM-141, AM900-10N, AM900-90, AMS900-10N, AMX, AMX-10HL, AMX-90, AMXR, AMXS, AMXT, AMXTS, AMXX, AMXXR, AMXXS, AUP, AUP-90, AUPS, AUXX, AUXXL-11N, AUXXLS-11N, AUXXR, AUXXS, AUXXT, AUXXTS, ECOMAX-602-10, ECOMAX-602-11, ECOMAX-602S-11, ECOMAX-612-10, ECOMAX-612S-10		

accessories for	520090		
	Part No.	361058	Ref. No. —
	container filter with non-return valve SS hose ø 4x6mm L 56mm		
	Part No.	361066	Ref. No. —
	container filter straight SS hose ø 4x6mm L 37mm non return valve ball valve		
	Part No.	361106	Ref. No. —
	container filter with weight and non-return valve SS hose ø 4x6mm ø 21mm L 51mm non return valve lip valve		
	Part No.	361141	Ref. No. 139321-594
	container filter with weight ceramic hose ø 4mm		
	Part No.	361230	Ref. No. —
	container filter with weight stainless steel hose ø 4x6mm		
	Part No.	361462	Ref. No. —
	container filter with weight SS hose ø 4x6mm		
	Part No.	361728	Ref. No. —
	container filter with 4m 4x6 hose SS hose ø 4x6mm hose length 4000mm		

tank inlets			
			
Part No.	361865	Ref. No.	00-883676-001 883676-1
description	tank inlet stainless steel M10x1 hose ø 5mm		
For models:	AM-11, AM900-10N, AM900-90, AMS900-10N, AMX, AMX-10HL, AMX-90, AMXR, AMXS, AMXT, AMXTS, AMXX, AMXXR, AMXXS, AUP, AUP-90, AUPS, AUXX, AUXXL-11N, AUXXLS-11N, AUXXR, AUXXS, AUXXT, AUXXTS, ECOMAX-402, ECOMAX-502, ECOMAX-602-11, ECOMAX-602S-11, ECOMAX-612-10, ECOMAX-612S-10, FP, FX, FX-McDonalds, GP, GX		

			
Part No.	361856	Ref. No.	139321-587
description	tank inlet stainless steel M12 hose ø 4/5/6mm		



hoses

supply hoses

stainless steel flexi hoses

universal hoses

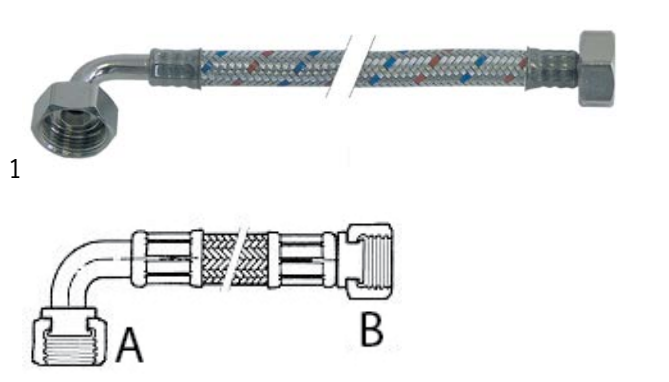

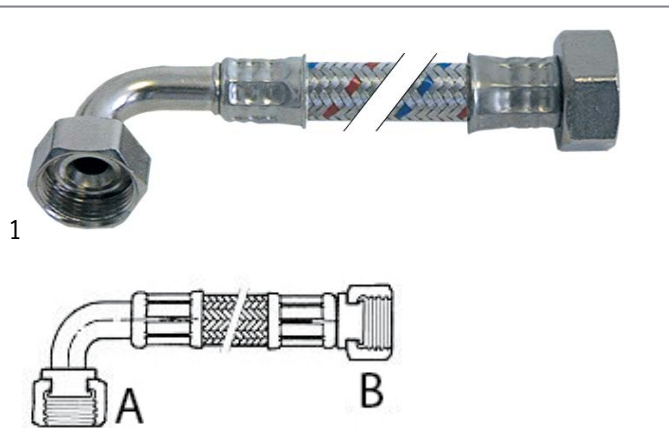

Part No.	520578	Ref. No.	01-240316-001 01-240316-1
description	flex hose SS braid straight-curved DN10 connection 1: 3/4" connection 2: 3/4" L 2000mm with integrated gasket approval DVGW operating p. 10bar test pressure 32bar burst p. 95bar		
For models:	AM900-10N, AM900-90, AMS900-10N, AMX, AMX-10HL, AMX-90, AMX-900, AMXR, AMXR-900, AMXS, AMXS-900, AMXT, AMXTS, AMXX, AMXX-1300, AMXXR, AMXXR-1300, AMXXS, AMXXS-1300, AMXXT, AUP, AUP-90, AUPS, AUXX, AUXX-1300, AUXXL-11N, AUXXLS-11N, AUXXR, AUXXR-1300, AUXXS, AUXXS-1300, AUXXT, AUXXTS, ECOMAX-402, ECOMAX-502, ECOMAX-602-11, ECOMAX-602S-11, ECOMAX-612-10, ECOMAX-612S-10, FP, FX, FX-McDonalds, GP, GX, UX, UXL, UXLS, UXS, UXT, UXTH...(Other models you can see in the webshop)		

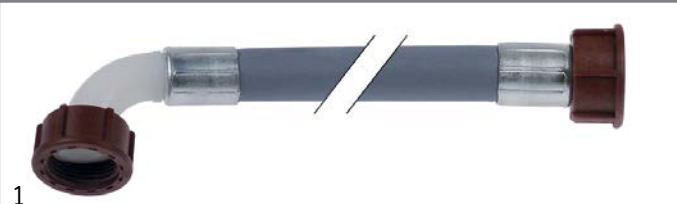

Part No.	520008	Ref. No.	139321-656
description	flex hose SS braid straight-curved DN12 connection 1: 3/4" connection 2: 3/4" L 1500mm approval DVGW operating p. 10bar test pressure 32bar burst p. 95bar		
accessories for	520008		
	Part No.	520054	Ref. No. —
	flat gasket rubber ED ø 23.5mm ID ø 14mm thickness 2.3mm Qty 10 pcs		

PVC supply hoses



Part No.	520010	Ref. No.	E143170
description	supply hose PVC straight-curved DN13 connections 3/4" L 1500mm operating p. 10bar burst p. 32bar t.max. 90°C blue approval VDE flat seal		
accessories for	520010		
	Part No.	520053	Ref. No. —
	screen connection 3/4" D1 ø 26mm D2 ø 15mm Qty 10 pcs rubber thickness 8mm		
	Part No.	520054	Ref. No. —
	flat gasket rubber ED ø 23.5mm ID ø 14mm thickness 2.3mm Qty 10 pcs		



Part No.	520011	Ref. No.	139321-1030 139321-1034
description	supply hose PVC straight-curved DN13 connections 3/4" L 2000mm operating p. 10bar burst p. 32bar t.max. 90°C approval VDE flat seal		

pre-rinse hoses

stainless steel spiral tubes with bend relief

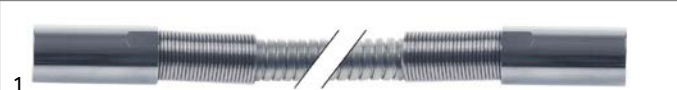

Part No.	540066 ¹	Ref. No.	170858
description	shower hose connections 1/2" L 1000mm SS operating p. 10bar burst p. 40bar t.max. 90°C approval KTW with integrated gasket DN 8mm		
spare parts for	540066		
	Part No.	504209	Ref. No. —
	flat gasket FIBER ED ø 18.5mm ID ø 11mm thickness 2mm Qty 1 pcs		

¹brass bush

drain hoses

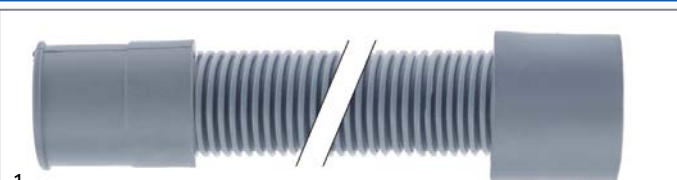

Part No.	518518	Ref. No.	139321-647
description	drain hose DN19 L 1500mm A int. ø 21mm A ext. ø 27mm B int. ø 29mm B ext. ø 35mm outer hose ø 25mm		

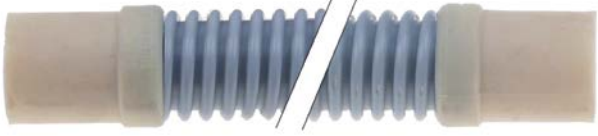
1

Part No.	530298	Ref. No.	00-324045-000
description	drain hose DN19 L 2100mm A int. ø 19mm A ext. ø 25mm B int. ø 19mm B ext. ø 25mm outer hose ø 24mm		
For models:	AM900, AMS900, AMX-900, AMX-ER, AMX-R, AMXR-900, AMXS-900, AMXX-1300, AMXXR-1300, AMXXS-1300, AMXXT, AUX-ER, AUX-R, AUXX-1300, AUXXL, AUXXR-1300, AUXXS-1300, AUXXT, ECOMAX-402, ECOMAX-502, ECOMAX-650, FE-W, FX, GC, GC11, GC12, GC31, GC32, GC41, GC42, GX, HX, HX-30, HX-30E, HX-30ES, HX-30S, HX-40, HX-40E, HX-40ES, HX-40S, HX-60-EHL, HX-E, HX-ES, HX-S, UX, UXL, UXLS, UXS, UXT, UXTH...(Other models you can see in the webshop)		



1

Part No.	513258	Ref. No.	139321-850
description	drain hose DN19 L 270mm A int. ø 22mm A ext. ø 28mm B int. ø 24mm B ext. ø 28mm outer hose ø 22mm		

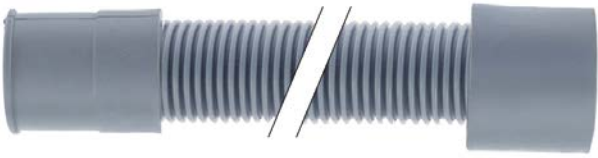

1

Part No.	518219	Ref. No.	139321-645
description	drain hose DN19 L 630mm A int. ø 20mm A ext. ø 27mm B int. ø 21mm B ext. ø 28mm outer hose ø 24mm		



1

Part No.	530570	Ref. No.	00-323801-001 323801-1
description	drain hose DN21 L 2000mm A int. ø 21mm A ext. ø 25mm B int. ø 20/29mm B ext. ø 27/35mm outer hose ø 25mm		
For models:	AM-10, AM-11, AM-141, AM-700, ECOMAX-402, ECOMAX-502, ECOMAX-600, ECOMAX-602-10, ECOMAX-602-11, ECOMAX-650, ECOMAX-700, FE, HE, HE600-HL, HE-P		



1

Part No.	530299	Ref. No.	00-883961-001 00-883961-002 01-243347-001 01-243347-1 883961-1 883961-2
description	drain hose DN19 L 2000mm straight ø inside 19mm straight ext. ø 25mm elbow ø inside 21mm elbow ext. ø 27mm outer hose ø 25mm		
For models:	AM-700, AM900-10N, AM900-90, AMS900-10N, AMX, AMX-10HL, AMX-90, AMX-900, AMXR, AMXR-900, AMXS, AMXS-900, AMXT, AMXTS, AMXX, AMXX-1300, AMXXR, AMXXR-1300, AMXXS, AMXXS-1300, AMXXT, AUP, AUP-90, AUPS, AUXX, AUXX-1300, AUXXL-11N, AUXXL-11N, AUXXR, AUXXR-1300, AUXXS, AUXXS-1300, AUXXT, AUXXTS, ECOMAX-600, ECOMAX-602S-11, ECOMAX-612-10, ECOMAX-612S-10, ECOMAX-700, FP, FX, FX-McDonalds, GP, GX, UX, UXL, UXLS, UXS, UXT, UXTH...(Other models you can see in the webshop)		



1

Part No.	518103	Ref. No.	139321-911
description	drain hose DN32 L 2000mm straight ø inside 31mm straight ext. ø 35mm elbow ø inside 51mm elbow ext. ø 58mm outer hose ø 38mm polypropylene		
For models:	CHH-50, CHH-60D, CHH-70D, EH-60, EH-70		

industrial hoses

Niplaflex hoses



1

Part No.	530562	Ref. No.	139321-940
description	pressure hose ID ø 13mm ED ø 21mm L 5m operating p. 10bar burst p. 30bar t.max. 110°C		

pressure control hoses



1

Part No.	530560	Ref. No.	139321-615
description	pressure control hose ID ø 5mm ED ø 9mm L 5m operating p. 30bar burst p. 90bar temp.-resist. 60°C		

PVC hoses

PVC hoses without fabric



1









Part No.	570000	Ref. No.	00-775611-004 775611-4
description	PVC hose ID ø 10mm ED ø 14mm L 1.1m thickness 2mm t.max. 60°C transparent		
For models:	ECOMAX-502, UXTH, UXTHS, UXTLH, UXTLHS		



			
Part No.	570126	Ref. No.	01-246301-010 01-246301-10
description	PVC hose ID ø 4mm ED ø 6mm L 0.28m thickness 1mm t.max. 60°C transparent		
For models:	AMX, AMX-10HL, AMX-90, AMXR, AMXS, AMXX, AMXXR, AMXXS, AUP, AUP-90, AUPS, AUXX, AUXXR, AUXXS, ECOMAX-402, ECOMAX-502		

			
Part No.	570124	Ref. No.	01-246301-008 01-246301-8
description	PVC hose ID ø 4mm ED ø 6mm L 0.5m thickness 1mm t.max. 60°C transparent		
For models:	AM-11, AM900-10N, AM900-90, AMS900-10N, AMX, AMX-10HL, AMX-90, AMXR, AMXS, AMXT, AMXTS, AMXX, AMXXR, AMXXS, AUP, AUP-90, AUPS, AUXX, AUXXL-11N, AUXXLS-11N, AUXXR, AUXXS, AUXXT, AUXXTS, ECOMAX-602-11, ECOMAX-602S-11, ECOMAX-612-10, ECOMAX-612S-10		

			
Part No.	520383	Ref. No.	H.775601
description	PVC hose ID ø 4mm ED ø 6mm L 2m thickness 1mm t.max. 60°C blue		
For models:	H-60		
accessories for	520383		
	Part No.	361058	Ref. No. —
		container filter with non-return valve SS hose ø 4x6mm ø 20mm L 56mm	
	Part No.	361066	Ref. No. —
		container filter straight SS hose ø 4x6mm L 37mm non return valve ball valve	
	Part No.	361106	Ref. No. —
		container filter with weight and non-return valve SS hose ø 4x6mm ø 21mm L 51mm non return valve lip valve	
	Part No.	361141	Ref. No. 139321-594
		container filter with weight ceramic hose ø 4mm	
	Part No.	361230	Ref. No. —
		container filter with weight stainless steel hose ø 4x6mm	
	Part No.	361462	Ref. No. —
		container filter with weight SS hose ø 4x6mm	
	Part No.	361728	Ref. No. —
		container filter with 4m 4x6 hose SS hose ø 4x6mm hose length 4000mm	

			
Part No.	520090	Ref. No.	00-898252-002 00-898252-005 898252-2 898252-5
description	PVC hose ID ø 4mm ED ø 6mm L 2m thickness 1mm t.max. 60°C transparent		
For models:	AM-10, AM-11, AM-141, AM-700, AM900, AM900-10N, AM900-90, AMS900, AMS900-10N, AMX, AMX-10HL, AMX-90, AMX-900, AMXR, AMXR-900, AMXS, AMXS-900, AMXT, AMXTS, AMXX, AMXX-1300, AMXXR, AMXXR-1300, AMXXS, AMXXS-1300, AMXXT, AUP, AUP-90, AUPS, AUXX, AUXX-1300, AUXXL, AUXXL-11N, AUXXLS-11N, AUXXR, AUXXR-1300, AUXXS, AUXXS-1300, AUXXT, AUXXTS, ECOMAX-600, ECOMAX-602-10, ECOMAX-602-11, ECOMAX-602S-11, ECOMAX-612-10, ECOMAX-612S-10, ECOMAX-650, ECOMAX-700, GC, GC11...(Other models you can see in the webshop)		
accessories for	520090		
	Part No.	361058	Ref. No. —
		container filter with non-return valve SS hose ø 4x6mm ø 20mm L 56mm	
	Part No.	361066	Ref. No. —
		container filter straight SS hose ø 4x6mm L 37mm non return valve ball valve	
	Part No.	361106	Ref. No. —
		container filter with weight and non-return valve SS hose ø 4x6mm ø 21mm L 51mm non return valve lip valve	
	Part No.	361141	Ref. No. 139321-594
		container filter with weight ceramic hose ø 4mm	
	Part No.	361230	Ref. No. —
		container filter with weight stainless steel hose ø 4x6mm	
	Part No.	361462	Ref. No. —
		container filter with weight SS hose ø 4x6mm	
	Part No.	361728	Ref. No. —
		container filter with 4m 4x6 hose SS hose ø 4x6mm hose length 4000mm	

			
Part No.	570123	Ref. No.	01-246301-001 01-246301-1
description	PVC hose ID ø 4mm ED ø 6mm L 3.5m thickness 1mm t.max. 60°C transparent		
For models:	ECOMAX-402, ECOMAX-502, FP, FX, FX-McDonalds, GP, GX, UX, UXL, UXLS, UXS, UXT, UXTL, UXTLS, UXTS		



			
1			
Part No.	570127	Ref. No.	01-246301-011 01-246301-11 01-515410-011
description	PVC hose ID \varnothing 4mm ED \varnothing 6mm L 4m thickness 1mm t.max. 60°C transparent		
For models:	AM-10, AM-11, AM-141, AM900-10N, AM900-90, AMS900-10N, AMX, AMX-10HL, AMX-90, AMXR, AMXS, AMXT, AMXTS, AMXX, AMXXR, AMXXS, AUP, AUP-90, AUPS, AUXX, AUXXL-11N, AUXXLS-11N, AUXXR, AUXXS, AUXXT, AUXXTS, ECOMAX-602-10, ECOMAX-602-11, ECOMAX-602S-11, ECOMAX-612-10, ECOMAX-612S-10		

			
2			
Part No.	520027	Ref. No.	00-324402-005 00-324402-014 139321-126 324402-14 324402-5
description	PVC hose ID \varnothing 4mm ED \varnothing 7mm L 10m thickness 1.5mm t.max. 60°C transparent		
For models:	CN, CNB, CR, ECOMAX-402, ECOMAX-502, ECW, FTN, GE-400, GF-60, GF-60S, GW-600, GW-600S, GW-601, GW-601S		

			
1			
Part No.	520029	Ref. No.	00-165168-001
description	PVC hose ID \varnothing 6mm ED \varnothing 9mm L 10m thickness 1.5mm t.max. 60°C transparent		

extraction and pressure hoses

			
1			
Part No.	530442	Ref. No.	492144-7
description	universal hose ID \varnothing 32mm ED \varnothing 40mm L 1m operating p. 10bar burst p. 30bar temp.-resist. -30 up to +80°C		

silicone hoses

without fabric

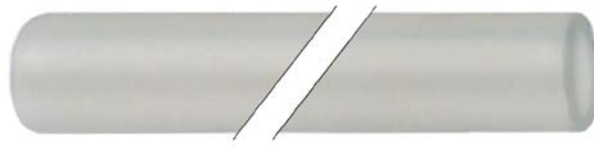
			
1			
Part No.	530821	Ref. No.	00-774080-001 774080-1
description	silicone hose ID \varnothing 10mm ED \varnothing 15mm L 1m thickness 2.5mm operating pressure without pressure burst pressure non defined t.max. 200°C transparent Shore 60°		
For models:	AM-10, AM-11, AM-141, AM-700, AM900, AM900-10N, AM900-90, AMS900, AMS900-10N, AMX, AMX-10HL, AMX-90, AMX-900, AMXR, AMXR-900, AMXS, AMXS-900, AMXT, AMXTS, AMXX, AMXX-1300, AMXXR, AMXXR-1300, AMXXS, AMXXS-1300, AMXXT, AUP, AUP-90, AUPS, AUXX, AUXX-1300, AUXXL, AUXXL-11N, AUXXLS-11N, AUXXR, AUXXR-1300, AUXXS, AUXXS-1300, AUXXT, AUXXTS, ECOMAX-402, ECOMAX-502, ECOMAX-600, ECOMAX-602-10, ECOMAX-602-11, ECOMAX-602S-11, ECOMAX-612-10, ECOMAX-612S-10, FP, FX... (Other models you can see in the webshop)		

formed hoses

straight

			
1			
Part No.	530278	Ref. No.	00-883776-001 883776-1
description	formed hose D1 \varnothing 24mm L 765mm for boiler ID \varnothing 17.5mm		
For models:	AM900-10N, AM900-90, AMS900-10N, AMX, AMX-10HL, AMX-90, AMXR, AMXS, AMXT, AMXTS, AMXX, AMXXR, AMXXS, AUP, AUP-90, AUPS, AUXX, AUXXL-11N, AUXXLS-11N, AUXXR, AUXXS, AUXXT, AUXXTS, ECOMAX-602-11, ECOMAX-602S-11, ECOMAX-612-10, ECOMAX-612S-10		

			
1			
Part No.	530276	Ref. No.	00-883721-001 883721-1
description	formed hose D1 \varnothing 25mm D2 \varnothing 17mm L 700mm for wash pump		
For models:	AM900-10N, AM900-90, AMS900-10N, AMX, AMX-10HL, AMX-90, AMXR, AMXS, AMXX, AMXXR, AMXXS, AUP, AUP-90, AUPS, AUXX, AUXXL-11N, AUXXLS-11N, AUXXR, AUXXS, ECOMAX-602-11, ECOMAX-602S-11, ECOMAX-612-10, ECOMAX-612S-10		

			
1			
Part No.	524228	Ref. No.	774060-1
description	formed hose dishwasher straight equiv. no. 12127		
For models:	EWB-S, FE, HE, HE600-HL, HE-P		

1

Part No.	518070	Ref. No.	139321-843
description	formed hose dishwasher straight mounting pos. upper equiv. no. 127026		



1

Part No.	518380	Ref. No.	139321-867
description	formed hose ext. ø 53 ID ø 43mm L 65mm dishwasher straight mounting pos. upper equiv. no. 127036		



1

Part No.	530290	Ref. No.	00-883775-001 883775-1
description	formed hose hose ext. ø 26mm hose int. ø 19mm L 655mm connection ø 23.5mm		
For models:	AM900-10N, AM900-90, AMS900-10N, AMX, AMX-10HL, AMX-90, AMXR, AMXS, AMXT, AMXTS, AMXX, AMXXR, AMXXS, AUP, AUP-90, AUPS, AUXX, AUXXL-11N, AUXXLS-11N, AUXXR, AUXXS, AUXXT, AUXXTS, ECOMAX-602-11, ECOMAX-602S-11, ECOMAX-612-10, ECOMAX-612S-10		



1

Part No.	508402	Ref. No.	00-883680-001 883680-1
description	formed hose hose ext. ø 32mm hose int. ø 26mm L 85mm		
For models:	AM900-10N, AM900-90, AMS900-10N, AMX, AMX-10HL, AMX-90, AMXR, AMXS, AMXT, AMXTS, AMXX, AMXXR, AMXXS, AUP, AUP-90, AUPS, AUXX, AUXXL-11N, AUXXLS-11N, AUXXR, AUXXS, AUXXT, AUXXTS, ECOMAX-602-11, ECOMAX-602S-11, ECOMAX-612-10, ECOMAX-612S-10		

form L



1

Part No.	507494	Ref. No.	00-898247-002 898247-2
description	formed hose end piece A ext. ø 19mm end piece A int. ø 13mm AD2 ø 19mm end piece B 13mm L 485mm for wash pipe		
For models:	AM-10, AM-11, AM-141, AM900-10N, AM900-90, AMS900-10N, AMX, AMX-10HL, AMX-90, AMXR, AMXS, AMXT, AMXTS, AMXX, AMXXR, AMXXS, AUP, AUP-90, AUPS, AUXX, AUXXL-11N, AUXXLS-11N, AUXXR, AUXXS, AUXXT, AUXXTS, ECOMAX-602-10, ECOMAX-602-11, ECOMAX-602S-11, ECOMAX-612-10, ECOMAX-612S-10, UXTH, UXTHL, UXTHLS, UXTHS, UXTLH, UXTLHS		



1

Part No.	507492	Ref. No.	00-898247-009 898247-9
description	formed hose end piece A ext. ø 20mm end piece A int. ø 13mm AD2 ø 19mm end piece B 12mm L 755mm		
For models:	AM-10, AM-11, AM-141, AM900-10N, AM900-90, AMS900-10N, AMX, AMX-10HL, AMX-90, AMXR, AMXS, AMXT, AMXTS, AMXX, AMXXR, AMXXS, AUP, AUP-90, AUPS, AUXX, AUXXL-11N, AUXXLS-11N, AUXXR, AUXXS, AUXXT, AUXXTS, ECOMAX-502, ECOMAX-602-10, ECOMAX-602-11, ECOMAX-602S-11, ECOMAX-612-10, ECOMAX-612S-10		



1

Part No.	507493	Ref. No.	00-883524-001 883524-1
description	formed hose end piece A ext. ø 36.5mm end piece A int. ø 29mm AD2 ø 30mm end piece B 22mm L 520mm drain tank - drain pump L-shape		
For models:	AM900-10N, AM900-90, AMS900-10N, AMX, AMX-10HL, AMX-90, AMXR, AMXS, ECOMAX-602-11, ECOMAX-612-10, ECOMAX-612S-10		



1

Part No.	513254	Ref. No.	139321-910
description	formed hose L 340mm warewashing L-shape equiv. no. 80186 ID ø 60mm		



1

Part No.	518225	Ref. No.	127041 139321-862
description	formed hose warewashing L-shape equiv. no. 127041		
For models:	ECOMAX-500		



form S



1

Part No.	510386	Ref. No.	324199
description	formed hose hose ext. \varnothing 21mm hose int. \varnothing 16mm L 195mm Qty 1 S-shape		
For models:	FX, GX, HX, HX-30, HX-30E, HX-30ES, HX-30S, HX-40, HX-40E, HX-40ES, HX-40S, HX-60-EHL, HX-E, HX-ES, HX-S		

form U



1

Part No.	518517	Ref. No.	139321-851
description	formed hose for drain pump D1 \varnothing 28mm D2 \varnothing 21mm warewashing U-shape		

for dishwashers

miscellaneous



1

Part No.	570126	Ref. No.	01-246301-010 01-246301-10
description	PVC hose ID \varnothing 4mm ED \varnothing 6mm L 0.28m thickness 1mm t.max. 60°C transparent		
For models:	AMX, AMX-10HL, AMX-90, AMXR, AMXS, AMXX, AMXXR, AMXXS, AUP, AUP-90, AUPS, AUXX, AUXXL-11N, AUXXLS-11N, AUXXR, AUXXS, ECOMAX-402, ECOMAX-502		



1

Part No.	570124	Ref. No.	01-246301-008 01-246301-8
description	PVC hose ID \varnothing 4mm ED \varnothing 6mm L 0.5m thickness 1mm t.max. 60°C transparent		
For models:	AM-11, AM900-10N, AM900-90, AMS900-10N, AMX, AMX-10HL, AMX-90, AMXR, AMXS, AMXT, AMXTS, AMXX, AMXXR, AMXXS, AUP, AUP-90, AUPS, AUXX, AUXXL-11N, AUXXLS-11N, AUXXR, AUXXS, AUXXT, AUXXTS, ECOMAX-602-11, ECOMAX-602S-11, ECOMAX-612-10, ECOMAX-612S-10		



1

Part No.	520592	Ref. No.	775552-1 895495 898045-1
description	supply hose service kit connections 3/4" L 2000mm SS straight-curved		
For models:	AMX, AMX-900, AMX-E, AMXR-900, AMXS-900, AMXX-1300, AMXXR-1300, AMXXS-1300, AMXXT, AUX, AUX-E, AUXX-1300, AUXXL, AUXXR-1300, AUXXS-1300, AUXXT, ECOMAX-650, FX, GX, UX, UXL, UXLS, UXS, UXT, UXTH, UXTHS, UXTL, UXTLH, UXTLHS, UXTLS, UXTS		

fittings, hose and pipe connectors

hose connectors

without screw connection



1

Part No.	541109	Ref. No.	139321-578
description	Y-piece plastic hose \varnothing 8-6-8mm for pressure switch		

hose connectors

brass



1

Part No.	513253	Ref. No.	139321-751
description	hose connector brass angled thread 1/4" hose \varnothing 12mm Qty 1 pcs		

producer-specific



1

Part No.	504377	Ref. No.	01-240159-001 01-240159-1
description	hose connector grommet \varnothing 23mm grommet length 25mm total length 55mm for water filling		
For models:	AM-10, AM-11, AM-141, AM900-10N, AM900-90, AMS900-10N, AMX, AMX-10HL, AMX-90, AMXR, AMXS, AMXT, AMXTS, AMXX, AMXXR, AMXXS, AUP, AUP-90, AUPS, AUXX, AUXXL-11N, AUXXLS-11N, AUXXR, AUXXS, AUXXT, AUXXTS, ECOMAX-602-10, ECOMAX-602-11, ECOMAX-602S-11, ECOMAX-612-10, ECOMAX-612S-10, FP, FX, FX-McDonalds, GP, GX		



			
1			
Part No.	520591	Ref. No.	139321-379
description	hose connector thread 1/4" angled grommet ø 12mm grommet length 17mm total length 38mm thread L 12mm brass		
For models:	GE-400, GF-60, GF-60S, GW-600, GW-600S, GW-601, GW-601S		

			
1			
Part No.	511679	Ref. No.	00-324071-000
description	T-piece connection 17.5mm plastic L 80mm W 40mm connection 1: 13.5mm connection 2: 13.5mm suitable for HOBART		
For models:	AM-10, AM-11, AM-141, AM900-10N, AM900-90, AMS900-10N, AMX, AMX-10HL, AMX-90, AMXR, AMXS, AMXT, AMXTS, AMXX, AMXXR, AMXXS, AUP, AUP-90, AUPS, AUXX, AUXXL-11N, AUXXLS-11N, AUXXR, AUXXS, AUXXT, AUXXTS, ECOMAX-402, ECOMAX-602-10, ECOMAX-602-11, ECOMAX-602S-11, ECOMAX-612-10, ECOMAX-612S-10, ECOMAX-700, FE, FP, FX, FX-McDonalds, GC, GC11, GC12, GC31, GC32, GP, GX, UX, UXL, UXLS, UXS, UXT, UXTH... (Other models you can see in the webshop)		
accessories for	511679		

			
Part No.	520573	Ref. No.	00-324510-202 324510-202
hose clamp ø 20mm wire gauge ø 2mm Qty 1 pcs			

valves and tank inlets

float valves

float valves

			
1			
Part No.	518118	Ref. No.	897665-1
description	float valve inlet 3/4" outlet 13.5mm input 3.5l/min output/min pressure range 0.3-10bar MÜLLER type 21.010.115 for water container flow regulating valve inlet dark blue flow regulating valve outlet		
For models:	CNA, CNB, CNR, CSA, FTN		

water softeners

accessories

			
1			
Part No.	530174	Ref. No.	00-775918-050 775918-150 775918-50
description	lid kit for softener		
For models:	ECOMAX-402, ECOMAX-502, ECOMAX-602S-11, ECOMAX-612S-10		



water filters

BRITA

water filters

PURITY Clean Extra

full desalination specifically for glasswashers

			
1			
Part No.	530849	Ref. No.	1008586
description	water filter BRITA type Purity 1200 Clean Extra capacity 5000l flow rate 300l/h operation p max 6bar water temperature +4 up to +60°C ø 288mm H 550mm full desalination for dishwashers		
accessories for	530849		
			
Part No.	520584	Ref. No.	—
flex hose SS straight-curved DN12 connection 1: 3/4" connection 2: 3/4" L 2000mm approval DVGW operating p. 10bar test pressure 32bar burst p. 95bar			

water cycle components

supply filters

			
1			
Part No.	520261	Ref. No.	E927078
description	supply filter thread 1/2" IT - 1/2" IT total length 58mm red brass mesh opening 0.4mm		



ancillary products

clamps

hose clamps

DIN 3017 - W2

			
1			
Part No.	520114	Ref. No.	423008
description	hose clamp ø 20-32mm width 9mm Qty 10 pcs DIN 3017		

double wire clamps

			
1			
Part No.	520573	Ref. No.	00-324510-202
description	hose clamp ø 20mm wire gauge ø 2mm Qty 1 pcs		
For models:	AMX, AMX-E, AMX-ER, AMX-R, AUX, AUX_, AUX-E, AUX-ER, AUX-R, ECOMAX-402, ECOMAX-502, ECOMAX-700, FE, FE-W, FP, FX, FX-McDonalds, GC41, GC42, GP, GX, HE, HE600-HL, HE-P, HX, HX-30, HX-30E, HX-30ES, HX-30S, HX-40, HX-40E, HX-40ES, HX-40S, HX-60-EHL, HX-E, HX-ES, HX-S, UX, UX-30, UX-30B, UX-30E, UX-30EB, UX-30EH, UX-30ES, UX-30ESB, UX-30ESH, UX-30H, UX-30-McDonalds, UX-30S, UX-30SB... (Other models you can see in the webshop)		

			
1			
Part No.	520577	Ref. No.	00-324510-242
description	hose clamp ø 24mm wire gauge ø 2mm Qty 1 pcs		
For models:	AMX, AMX-E, AMX-ER, AMX-R, AMXX-1300, AMXXR-1300, AMXXS-1300, AUX, AUX_, AUX-E, AUX-ER, AUX-R, AUXX-1300, AUXXR-1300, AUXXS-1300, CN, CNA, CNB, CNR, CR, ECOMAX-402, ECOMAX-502, ECOMAX-700, FE, FE-W, FP, FX, FX-McDonalds, GC, GC11, GC12, GC31, GC32, GC41, GC42, GP, GX, HE-P, HX, HX-30, HX-30E, HX-30ES, HX-30S, HX-40, HX-40E, HX-40ES, HX-40S, HX-60-EHL, HX-E, HX-ES... (Other models you can see in the webshop)		

			
1			
Part No.	520574	Ref. No.	00-324510-327
description	hose clamp ø 32mm wire gauge ø 3mm Qty 1 pcs		
For models:	AMX, AMX-900, AMX-E, AMX-ER, AMX-R, AMXR-900, AMXS-900, AMXX-1300, AMXXR-1300, AMXXS-1300, AMXXT, AUX, AUX-E, AUXER, AUX-R, AUXX-1300, AUXXL, AUXXR-1300, AUXXS-1300, AUXXT, ECOMAX-502, ECOMAX-650, ECOMAX-700, FE, FP, FX, FX-McDonalds, GP, GX, UX, UXD-30, UXL, UXLS, UXS, UXT, UXTH, UXTHL, UXTHLS, UXTHS, UXTL, UXTLH, UXTLHS, UXTLS, UXTS		

			
1			
Part No.	513268	Ref. No.	00-303340-008 00-324510-068 139321-580 303340-8 324510-68
description	hose clamp ø 8-10mm wire gauge ø 1mm Qty 1 pcs		
For models:	AM-10, AM-11, AM-141, AM-700, AM900, AM900-10N, AM900-90, AMS900, AMS900-10N, AMX, AMX-10HL, AMX-90, AMX-900, AMXR, AMXR-900, AMXS, AMXS-900, AMXT, AMXTS, AMXX, AMXX-1300, AMXXR, AMXXR-1300, AMXXS, AMXXS-1300, AMXXT, AUP, AUP-90, AUPS, AUXX, AUXX-1300, AUXXL, AUXXL-11N, AUXXLS-11N, AUXXR, AUXXR-1300, AUXXS, AUXXS-1300, AUXXT, AUXXTS, CHF45, ECOMAX-600, ECOMAX-602-10, ECOMAX-602-11, ECOMAX-602S-11, ECOMAX-612-10, ECOMAX-612S-10, ECOMAX-650, ECOMAX-700, EF-40... (Other models you can see in the webshop)		

<p>double wire clamps with screw</p> 			
1			
Part No.	505281	Ref. No.	00-323945-015 323945-15
description	hose clamp ø 15mm zinc-coated steel Qty 20 pcs		
For models:	AM-10, AM-11, AM-141, AM-700, AM900, AM900-10N, AM900-90, AMS900, AMS900-10N, AMX, AMX-10HL, AMX-90, AMX-900, AMXR, AMXR-900, AMXS, AMXS-900, AMXT, AMXTS, AMXX, AMXX-1300, AMXXR, AMXXR-1300, AMXXS, AMXXS-1300, AMXXT, AUP, AUP-90, AUPS, AUXX, AUXX-1300, AUXXL, AUXXL-11N, AUXXLS-11N, AUXXR, AUXXR-1300, AUXXS, AUXXS-1300, AUXXT, AUXXTS, ECOMAX-402, ECOMAX-502, ECOMAX-600, ECOMAX-602-10, ECOMAX-602-11, ECOMAX-602S-11, ECOMAX-612-10, ECOMAX-612S-10, FP, FX... (Other models you can see in the webshop)		

			
1			
Part No.	505282	Ref. No.	00-323945-016 323945-16
description	hose clamp ø 16mm zinc-coated steel Qty 20 pcs		
For models:	AM-700, AM900, AMS900, AMX, AMX-900, AMX-E, AMX-ER, AMX-R, AMXR-900, AMXS-900, AMXX-1300, AMXXR-1300, AMXXS-1300, AMXXT, AUX, AUX-E, AUX-ER, AUX-R, AUXX-1300, AUXXL, AUXXR-1300, AUXXS, AUXXS-1300, AUXXT, ECOMAX-402, ECOMAX-502, ECOMAX-600, ECOMAX-650, GC, UX, UXL, UXLS, UXS, UXT, UXTH, UXTHL, UXTHLS, UXTHS, UXTL, UXTLH, UXTLHS, UXTLS, UXTS		

1

Part No.	505283	Ref. No.	00-323945-018 323945-18
description	hose clamp ø 18mm zinc-coated steel Qty 20 pcs		
For models:	AM-10, AM-11, AM-141, AM-700, AM900, AM900-10N, AM900-90, AMS900, AMS900-10N, AMX, AMX-10HL, AMX-90, AMX-900, AMX-E, AMX-ER, AMXR, AMX-R, AMXR-900, AMXS, AMXS-900, AMXT, AMXTS, AMXX, AMXX-1300, AMXXR, AMXXR-1300, AMXXS, AMXXS-1300, AMXXT, AUP, AUP-90, AUPS, AUX, AUX-E, AUX-ER, AUX-R, AUXX, AUXX-1300, AUXXL-11N, AUXXLS-11N, AUXXR, AUXXR-1300, AUXXS, AUXXS-1300, AUXXT, AUXXTS, ECOMAX-402, ECOMAX-502, ECOMAX-600, ECOMAX-602-10...(Other models you can see in the webshop)		



1

Part No.	505286	Ref. No.	00-323945-029 323945-29
description	hose clamp ø 29mm zinc-coated steel Qty 20 pcs		
For models:	AM900-10N, AM900-90, AMS900-10N, AMX, AMX-10HL, AMX-90, AMX-E, AMX-ER, AMXR, AMX-R, AMXS, AMXT, AMXTS, AMXX, AMXX-1300, AMXXR, AMXXR-1300, AMXXS, AMXXS-1300, AMXXT, AUP, AUP-90, AUPS, AUX, AUX-E, AUX-ER, AUX-R, AUXX, AUXX-1300, AUXXL, AUXXL-11N, AUXXLS-11N, AUXXR, AUXXR-1300, AUXXS, AUXXS-1300, AUXXT, AUXXTS, CR, CR-F, ECOMAX-602-11, ECOMAX-602S-11, ECOMAX-612-10, ECOMAX-612S-10, ECOMAX-700, FE, GC, GC11, GC12, GC31...(Other models you can see in the webshop)		



1

Part No.	505284	Ref. No.	00-323945-019 00-323945-021 323945-19 -alt 323945-21
description	hose clamp ø 21mm zinc-coated steel Qty 20 pcs		
For models:	AM-10, AM-11, AM-141, AM-700, AM900-10N, AM900-90, AMS900-10N, AMX, AMX-10HL, AMX-90, AMX-E, AMX-ER, AMXR, AMX-R, AMXS, AMXT, AMXTS, AMXX, AMXX-1300, AMXXR, AMXXR-1300, AMXXS, AMXXS-1300, AMXXT, AUP, AUP-90, AUPS, AUX, AUX-E, AUX-ER, AUX-R, AUXX, AUXX-1300, AUXXL, AUXXL-11N, AUXXLS-11N, AUXXR, AUXXR-1300, AUXXS, AUXXS-1300, AUXXT, AUXXTS, ECOMAX-402, ECOMAX-502, ECOMAX-600, ECOMAX-602-10, ECOMAX-602-11, ECOMAX-602S-11, ECOMAX-612-10, ECOMAX-612S-10...(Other models you can see in the webshop)		



1

Part No.	505287	Ref. No.	00-323945-033 323945-33
description	hose clamp ø 33mm zinc-coated steel Qty 20 pcs		
For models:	AM-700, AM900, AM900-10N, AM900-90, AMS900, AMS900-10N, AMX, AMX-10HL, AMX-90, AMX-900, AMXR, AMXR-900, AMXS, AMXS-900, AMXX, AMXXR, AMXXS, AUP, AUP-90, AUPS, AUXX, AUXXL-11N, AUXXLS-11N, AUXXR, AUXXS, CN-Protronic, CN-Smartronic, CP-Protronic, CR-F, ECOMAX-402, ECOMAX-502, ECOMAX-600, ECOMAX-602-11, ECOMAX-612-10, ECOMAX-612S-10, ECOMAX-650, ECOMAX-700, FX, GC31, GC32, GC41, GC42, GX		



1

Part No.	505285	Ref. No.	00-323945-025 323945-25
description	hose clamp ø 25mm zinc-coated steel Qty 20 pcs		
For models:	AM-10, AM-11, AM-141, AM-700, AM900, AM900-10N, AM900-90, AMS900, AMS900-10N, AMX, AMX-10HL, AMX-90, AMX-900, AMX-E, AMX-ER, AMXR, AMX-R, AMXR-900, AMXS, AMXS-900, AMXT, AMXTS, AMXX, AMXX-1300, AMXXR, AMXXR-1300, AMXXS, AMXXS-1300, AMXXT, AUP, AUP-90, AUPS, AUX, AUX-E, AUX-ER, AUX-R, AUXX, AUXX-1300, AUXXL, AUXXL-11N, AUXXLS-11N, AUXXR, AUXXR-1300, AUXXS, AUXXS-1300, AUXXT, AUXXTS, ECOMAX-402, ECOMAX-502, ECOMAX-600...(Other models you can see in the webshop)		





1

Part No.	505293	Ref. No.	00-323945-035 323945-35
description	hose clamp ø 34-38mm zinc-coated steel Qty 20 pcs		
For models:	AM900-10N, AM900-90, AMS900-10N, AMX, AMX-10HL, AMX-90, AMXR, AMXS, AMXT, AMXTS, AMXX, AMXXR, AMXXS, AUP, AUP-90, AUPS, AUXX, AUXXL-11N, AUXXLS-11N, AUXXR, AUXXS, AUXXT, AUXXTS, CR, CR-F, ECOMAX-402, ECOMAX-502, ECOMAX-602-11, ECOMAX-602S-11, ECOMAX-612-10, ECOMAX-612S-10, ECOMAX-650		



 <p>1</p>			
Part No.	505290	Ref. No.	00-323945-037 323945-37
description	hose clamp ø 37mm zinc-coated steel Qty 10 pcs		
For models:	AM-700, AM900, AMS900, AMX-900, AMXR-900, AMXS-900, AMXT, AMXTS, AMXX-1300, AMXXR-1300, AMXXS-1300, AMXXT, AUXX-1300, AUXXL, AUXXR-1300, AUXXS-1300, AUXXT, AUXXTS, CR, ECOMAX-402, ECOMAX-502, ECOMAX-600, ECOMAX-700, FP, FX, FX-McDonalds, GC41, GC42, GP, GX, UX, UXL, UXLS, UXS, UXT, UXTH, UXTHL, UXTHLS, UXTHS, UXTL, UXTLH, UXTLHS, UXTLS, UXTS		

 <p>1</p>			
Part No.	505292	Ref. No.	00-323945-064 323945-64
description	hose clamp ø 64-68mm zinc-coated steel Qty 10 pcs		
For models:	AM-10, AM-11, AM-141, AM900-10N, AM900-90, AMS900-10N, AMX, AMX-10HL, AMX-90, AMXR, AMXS, AMXT, AMXTS, AUXXT, AUXXTS, CN-Protronic, CN-Smartronic, CP-Protronic, CS-Easytronic, ECOMAX-602-10, ECOMAX-602-11, ECOMAX-602S-11, ECOMAX-612-10, ECOMAX-612S-10, ECOMAX-700, UX, UXL, UXLS, UXS, UXT, UXTL, UXTLS, UXTS		

 <p>1</p>			
Part No.	505294	Ref. No.	00-323945-053 323945-53
description	hose clamp ø 53mm zinc-coated steel Qty 10 pcs		
For models:	CN-Protronic, CN-Smartronic, CP-Protronic, CSA, CS-Easytronic, ECOMAX-402, ECOMAX-502, FE, GC, GC11, GC12, GC31, GC32, GC41, GC42, HE, HE600-HL, HE-P, UX-30, UX-30B, UX-30E, UX-30EB, UX-30EH, UX-30ES, UX-30ESB, UX-30ESH, UX-30H, UX-30-McDonalds, UX-30S, UX-30SB, UX-30SH, UX-60, UX-60B, UX-60E, UX-60EB, UX-60EH, UX-60EHB, UX-60H, UX-60HB		

 <p>1</p>			
Part No.	505291	Ref. No.	00-323945-056 323945-56
description	hose clamp ø 56mm zinc-coated steel Qty 10 pcs		
For models:	AM-700, AM900, AMS900, AMX-900, AMXR-900, AMXS-900, CR, ECOMAX-402, ECOMAX-502, ECOMAX-600, ECOMAX-650, FE, HE, HE600-HL, HE-P		

 <p>1</p>			
Part No.	505289	Ref. No.	00-323945-060 323945-60
description	hose clamp ø 60mm zinc-coated steel Qty 10 pcs		
For models:	AM-10, AM-11, AM-141, AM900-10N, AM900-90, AMS900-10N, AMX, AMX-10HL, AMX-90, AMXR, AMXS, AMXT, AMXTS, AMXX, AMXXR, AMXXS, AUP, AUP-90, AUPS, AUXX, AUXXL-11N, AUXXLS-11N, AUXXR, AUXXS, AUXXT, AUXXTS, CSA, ECOMAX-602-10, ECOMAX-602-11, ECOMAX-602S-11, ECOMAX-612-10, ECOMAX-612S-10		

measuring equipment

thermometers

built-in thermometers

 <p>1</p>			
Part No.	541969	Ref. No.	228720-2 228720-3
description	thermometer mounting measurements 58x25.5mm +30 up to +120°C capillary pipe 3000mm probe ø 8.5mm probe L 35mm		
For models:	AMX, AMX-R, AUX, AUX-R, CR-F, CSA, ECOMAX-600, ECOMAX-700, ECOMAX-800, ECW, FX, GX, HX-30, HX-30S, HX-40, HX-40S, UW-120, UW-200, UX-30, UX-30B, UX-30S, UX-30SB, UX-60, UX-60B		

fastening material

screws

countersunk screws

 <p>1</p>			
Part No.	560215	Ref. No.	603182
description	countersunk screw thread M5 L 14mm SS DIN 963/ISO 2009 Qty 20 pcs intake slotted head ø 9.2mm		
For models:	CR, FE, FE-W, FX, GC, GC11, GC12, GC31, GC32, GC41, GC42, GX, HE, HE600-HL, HE-P, HX, HX-30, HX-30E, HX-30ES, HX-30S, HX-40, HX-40E, HX-40ES, HX-40S, HX-60-EHL, HX-E, HX-ES, HX-S, UXD-30		



flat-headed bolts



1

Part No.	560062	Ref. No.	603455
description	flat-headed bolt thread M4 thread L 10mm SS DIN 7985/ISO 7045 Qty 20 pcs intake Phillips head ø 8mm head thickness 2mm		
For models:	CO-0611E, CO-1011E, CO-2011E, CS-0611E, CS-1011E, CS-2011E, CSD-0611E, CSD-1011E, CSD-2011E, UW-105		



1

Part No.	560061	Ref. No.	602687
description	flat-headed bolt thread M4 thread L 6mm SS DIN 7985/ISO 7045 Qty 20 pcs intake Phillips head ø 8mm head thickness 2mm		
For models:	AMX, AMX-E, AMX-ER, AMX-R, AUX, AUX_, AUX-E, AUX-ER, AUX-R, ECOMAX-600, ECOMAX-700, FE, FUX, FX, GX, HE, HE600-HL, HE-P, HX, HX-30, HX-30E, HX-30ES, HX-30S, HX-40, HX-40E, HX-40ES, HX-40S, HX-E, HX-ES, HX-S, UX-30, UX-30B, UX-30E, UX-30EB, UX-30EH, UX-30ES, UX-30ESB, UX-30ESH, UX-30H, UX-30-McDonalds, UX-30S, UX-30SB, UX-30SH, UX-60, UX-60B, UX-60E, UX-60EB, UX-60EH, UX-60EHB, UX-60H...(Other models you can see in the webshop)		



1

Part No.	560067	Ref. No.	140506-27
description	flat-headed bolt thread M5 thread L 10mm SS DIN 7985/ISO 7045 Qty 20 pcs intake Phillips head ø 8mm head thickness 2mm		
For models:	VPU-100, VPU-6		

hexagonal screws



1

Part No.	550528	Ref. No.	00-609782-000
description	safety screw thread M5 WS 8 Qty 10 pcs L 8mm head ø 11mm		
For models:	AM-10, AM-11, AM-141, AM900-10N, AM900-90, AMS900-10N, AMX, AMX-10HL, AMX-90, AMXR, AMXS, AMXT, AMXTS, AMXX, AMXXR, AMXXS, AUP, AUP-90, AUPS, AUX, AUXL-11N, AUXLS-11N, AUXXR, AUXXS, AUXXT, AUXXTS, ECOMAX-602-10, ECOMAX-602-11, ECOMAX-602S-11, ECOMAX-612-10, ECOMAX-612S-10		

grub screws

DIN 913/ISO 4026



1

Part No.	504733	Ref. No.	VA-261-1
description	grub screw thread M4 L 5mm stainless steel DIN 913 intake internal hexagon WS 2 Qty 1 pcs		

knurled screws



1

Part No.	510112	Ref. No.	139321-107 139321-873
description	Thumb screw thread M10 thread L 10mm ø 22mm H 4.5mm SS		
For models:	GE-400, GW-600, GW-600S, GW-601, GW-601S		

nuts

knurled nuts



1

Part No.	518152	Ref. No.	01-240205-001 01-240205-1 324036
description	knurled nut thread M12x1 ø 32mm H 3mm mounting pos. upper/lower SS for wash arm ID ø 11.5mm ED ø 32mm thickness 3mm		
For models:	AM-10, AM-11, AM-141, AM-700, AM900, AM900-10N, AM900-90, AMS900, AMS900-10N, AMX, AMX-10HL, AMX-90, AMX-900, AMX-E, AMX-ER, AMXR, AMX-R, AMXR-900, AMXS, AMXS-900, AMXT, AMXTS, AMXX, AMXX-1300, AMXXR, AMXXR-1300, AMXXS, AMXXS-1300, AMXXT, AUP, AUP-90, AUPS, AUX, AUX_, AUX-E, AUX-ER, AUX-R, AUX, AUX-1300, AUXL, AUXL-11N, AUXLS-11N, AUXXR, AUXXR-1300, AUXXS, AUXXS-1300, AUXXT, AUXXTS, ECOMAX-402, ECOMAX-502...(Other models you can see in the webshop)		

hexagonal nuts

DIN 934 / ISO 4032/8673





1

Part No.	511212	Ref. No.	602491
description	hexagonal nut thread M6 H 5mm WS 10 SS DIN/ISO DIN 934 / ISO 4032/8673 Qty 1 pcs		
For models:	ACW, AM-600, AM-600C, AM-600R, AMX, AMX-E, AMX-ER, AMX-R, AMXX-1300, AMXXR-1300, AMXXS-1300, AMXXT, AUX, AUX_, AUX-E, AUX-ER, AUX-R, AUX-1300, AUXL, AUXLR-1300, AUXXS-1300, AUXXT, CDC, CNA, CNR, CO-0611E, CO-0612E, CO-1011E, CO-1012E, CO-2011E, CS-0611E, CS-0612E, CS-0612E-A, CS-1011E, CS-1012E, CS-1012E-A, CS-1012G, CS-1022E, CS-1022E-A, CS-2011E, CS-2012E, CS-2022E, CSD-0611E, CSD-0612E, CSD-0612E-A, CSD-1011E, CSD-1012E, CSD-1012E-A, CSD-1013G...(Other models you can see in the webshop)		





DIN 985			
			
1			
Part No.	560460	Ref. No.	602504
description	hexagonal nut thread M10 H 15mm SS WS 17 self-locking Qty 1 pcs DIN/ISO 985		
For models:	AM-600, AM-600C, AM-600CR, AM-600R, AM900, AMS900, AMX-900, AMXR-900, AMXS-900, AMXX-1300, AMXXR-1300, AMXXS-1300, AMXXT, AUXX-1300, AUXXR-1300, AUXXS-1300, AUXXT, CDC, CN, CNA, CNB, CNR, CTC, ECOMAX-700, ECW, FTX, FUX, MS-34R, MS-41R, UW-105, UW-120, UW-125, UW-135, UW-135H, UW-200, UW-205, UX, UXL, UXLS, UXS, UXT, UXTH, UXTHL, UXTHLS, UXTHS, UXTL, UXTLH, UXTLHS, UXTLS, UXTS		

miscellaneous			
			
1			
Part No.	696438	Ref. No.	00-775460-001 775460-1
description	expanding nut plastic Qty 1 pcs for sheet-metal screw		
For models:	AM-10, AM-11, AM-141, AM-700, AM900, AM900-10N, AM900-90, AMS900, AMS900-10N, AMX, AMX-10HL, AMX-90, AMX-900, AMXR, AMXR-900, AMXS, AMXS-900, AMXT, AMXTS, AMXX, AMXX-1300, AMXXR, AMXXR-1300, AMXXS, AMXXS-1300, AMXXT, AUP, AUP-90, AUPS, AUXX, AUXX-1300, AUXXL, AUXXL-11N, AUXXLS-11N, AUXXR, AUXXR-1300, AUXXS, AUXXS-1300, AUXXT, AUXXTS, ECOMAX-600, ECOMAX-602-10, ECOMAX-602-11, ECOMAX-602S-11, ECOMAX-612-10, ECOMAX-612S-10, ECOMAX-650, ECOMAX-700, FP, FX... (Other models you can see in the webshop)		

washers			
spring rings			
			
1			
Part No.	560121	Ref. No.	371020-562 602308 VC032-09
description	lock washer ID ø 4.2mm ED ø 8mm SS DIN127 Qty 20 pcs for thread M4		
For models:	AM-600, AM-600C, AM-600CR, AM-600R, AMX, AMX-E, AMX-ER, AMX-R, AUX, AUX_, AUX-E, AUX-ER, AUX-R, CO-0611E, CO-0612E, CO-1011E, CO-1012E, CO-2011E, CS-0423E, CS-0423EK, CS-0523E, CS-0523EK, CS-0611E, CS-0612E, CS-1011E, CS-1012E, CS-1012E-A, CS-1022E, CS-1022E-A, CS-2011E, CS-2012E, CS-2022E, CS-423E, CS-423K, CSD-0611E, CSD-0612E, CSD-0612ET, CSD-1011E, CSD-1012E, CSD-1012E-A, CSD-1012ET, CSD-1013G, CSD-1022E, CSD-1022E-A, CSD-2011E, CSD-2012E, CSD-2012ET, CSD-2013G, CSD-2022E, CSL-0423E... (Other models you can see in the webshop)		

			
1			
Part No.	560122	Ref. No.	140506-28 602306
description	lock washer ID ø 5.2mm ED ø 9mm SS DIN127 Qty 20 pcs for thread M5		
For models:	AM-600, AM-600C, AM-600CR, AM-600R, CO-0611E, CO-0612E, CO-1011E, CO-1012E, CO-2011E, CS-0611E, CS-0612E, CS-0612E-A, CS-1011E, CS-1012E, CS-1012E-A, CS-1012G, CS-1022E, CS-1022E-A, CS-2011E, CS-2012E, CS-2012G, CS-2022E, CSD-0611E, CSD-0612E, CSD-0612E-A, CSD-1011E, CSD-1012E, CSD-1012E-A, CSD-1013G, CSD-1022E, CSD-1022E-A, CSD-2011E, CSD-2012E, CSD-2013G, CSD-2022E, FE, FE-W, FM-400H, FM-400U, FM-500, FM-500H, FTX, FUX, FX, G10R, G5R, GX, HE-P, HX, HX-30... (Other models you can see in the webshop)		

washers			
DIN 125A			
			
1			
Part No.	560356	Ref. No.	602288
description	plain washer ID ø 10.5mm ED ø 20mm thickness 2mm SS Qty 1 pcs DIN 125A for thread M10		
For models:	ACW, AM-600, AM-600C, AM-600CR, AM-600R, AM-700, AM900, AMS900, AMX, AMX-900, AMX-E, AMX-ER, AMX-R, AMXR-900, AMXS-900, AMXX-1300, AMXXR-1300, AMXXS-1300, AMXXT, AUX, AUX_, AUX-E, AUX-ER, AUX-R, AUXX-1300, AUXXL, AUXXR-1300, AUXXS-1300, AUXXT, CDC, CN, CNA, CNB, CNR, CO-2011E, CS-2011E, CSD-2011E, CTC, ECOMAX-600, ECOMAX-650, ECOMAX-700, ECW, FE-W, FTN, FTT, FTX, FUX, FX, GC, GC11... (Other models you can see in the webshop)		

miscellaneous			
			
1			
Part No.	692307	Ref. No.	01-240789-001 01-240789-1
description	plain washer for hinge ID ø 8mm ED ø 18mm plastic thickness 1mm Qty 1 pcs		
For models:	ECOMAX-502		

			
1			
Part No.	524117	Ref. No.	602286
description	plain washer ID ø 6.4mm ED ø 12mm thickness 1.6mm SS Qty 1 pcs		



tooth lock washers

DIN 6798A

1

Part No.	560509	Ref. No.	602316
description	tooth lock washer ID ø 15mm ED ø 24mm SS Qty 1 pcs for thread 1/4"		
For models:	AM-12E, AM-12EC, AM-12EF, AM-12ER, AM-600, AM-600C, AM-600CR, AM-600R, CN, CNA, CNB, CNR, CR, CR-F, CSA, CX, ECOMAX-800, EWB-S, FTN, FTT, FTX, FUX, UW-105, UW-135, UW-135H, UWX		

fasteners

slot nuts



1

Part No.	560283	Ref. No.	12430-59 D-12430-59
description	slot nut W 5mm H 5mm L 25mm		
For models:	A-200, A-200DT, A-200FM, A-200FT, A-200N, A-200T, HSM20, NCM20		

clamps

hose clamps

DIN 3017 - W2



1

Part No.	520114	Ref. No.	423008
description	hose clamp ø 20-32mm width 9mm Qty 10 pcs DIN 3017		

double wire clamps



1

Part No.	520573	Ref. No.	00-324510-202
description	hose clamp ø 20mm wire gauge ø 2mm Qty 1 pcs		
For models:	AMX, AMX-E, AMX-ER, AMX-R, AUX, AUX_, AUX-E, AUX-ER, AUX-R, ECOMAX-402, ECOMAX-502, ECOMAX-700, FE, FE-W, FP, FX, FX-McDonalds, GC41, GC42, GP, GX, HE, HE600-HL, HE-P, HX, HX-30, HX-30E, HX-30ES, HX-30S, HX-40, HX-40E, HX-40ES, HX-40S, HX-60-EHL, HX-E, HX-ES, HX-S, UX, UX-30, UX-30B, UX-30E, UX-30EB, UX-30EH, UX-30ES, UX-30ESB, UX-30ESH, UX-30H, UX-30-McDonalds, UX-30S, UX-30SB... (Other models you can see in the webshop)		



1

Part No.	520577	Ref. No.	00-324510-242
description	hose clamp ø 24mm wire gauge ø 2mm Qty 1 pcs		
For models:	AMX, AMX-E, AMX-ER, AMX-R, AMXX-1300, AMXXR-1300, AMXXS-1300, AUX, AUX_, AUX-E, AUX-ER, AUX-R, AUXX-1300, AUXXR-1300, AUXXS-1300, CN, CNA, CNB, CNR, CR, ECOMAX-402, ECOMAX-502, ECOMAX-700, FE, FE-W, FP, FX, FX-McDonalds, GC, GC11, GC12, GC31, GC32, GC41, GC42, GP, GX, HE-P, HX, HX-30, HX-30E, HX-30ES, HX-30S, HX-40, HX-40E, HX-40ES, HX-40S, HX-60-EHL, HX-E, HX-ES... (Other models you can see in the webshop)		



1

Part No.	520574	Ref. No.	00-324510-327
description	hose clamp ø 32mm wire gauge ø 3mm Qty 1 pcs		
For models:	AMX, AMX-900, AMX-E, AMX-ER, AMX-R, AMXR-900, AMXS-900, AMXX-1300, AMXXR-1300, AMXXS-1300, AMXXT, AUX, AUX-E, AUXER, AUX-R, AUXX-1300, AUXXL, AUXXR-1300, AUXXS-1300, AUXXT, ECOMAX-502, ECOMAX-650, ECOMAX-700, FE, FP, FX, FX-McDonalds, GP, GX, UX, UXD-30, UXL, UXLS, UXS, UXT, UXTH, UXTHL, UXTHLS, UXTHS, UXTL, UXTLH, UXTLHS, UXTLS, UXTS		



1

Part No.	513268	Ref. No.	00-303340-008 00-324510-068 139321-580 303340-8 324510-68
description	hose clamp ø 8-10mm wire gauge ø 1mm Qty 1 pcs		
For models:	AM-10, AM-11, AM-141, AM-700, AM900, AM900-10N, AM900-90, AMS900, AMS900-10N, AMX, AMX-10HL, AMX-90, AMX-900, AMXR, AMXR-900, AMXS, AMXS-900, AMXT, AMXTS, AMXX, AMXX-1300, AMXXR, AMXXR-1300, AMXXS, AMXXS-1300, AMXXT, AUP, AUP-90, AUPS, AUX, AUX-1300, AUXXL, AUXXL-11N, AUXXLS-11N, AUXXR, AUXXR-1300, AUXXS, AUXXS-1300, AUXXT, AUXXTS, CHF45, ECOMAX-600, ECOMAX-602-10, ECOMAX-602-11, ECOMAX-602S-11, ECOMAX-612-10, ECOMAX-612S-10, ECOMAX-650, ECOMAX-700, EF-40... (Other models you can see in the webshop)		



double wire clamps with screw

1



Part No.	505281	Ref. No.	00-323945-015 323945-15
description	hose clamp ø 15mm zinc-coated steel Qty 20 pcs		
For models:	AM-10, AM-11, AM-141, AM-700, AM900, AM900-10N, AM900-90, AMS900, AMS900-10N, AMX, AMX-10HL, AMX-90, AMX-900, AMXR, AMXR-900, AMXS, AMXS-900, AMXT, AMXTS, AMXX, AMXX-1300, AMXXR, AMXXR-1300, AMXXS, AMXXS-1300, AMXXT, AUP, AUP-90, AUPS, AUX, AUX-1300, AUXXL, AUXXL-11N, AUXXLS-11N, AUXXR, AUXXR-1300, AUXXS, AUXXS-1300, AUXXT, AUXXTS, ECOMAX-402, ECOMAX-502, ECOMAX-600, ECOMAX-602-10, ECOMAX-602-11, ECOMAX-602S-11, ECOMAX-612-10, ECOMAX-612S-10, FP, FX... (Other models you can see in the webshop)		

1



Part No.	505284	Ref. No.	00-323945-019 00-323945-021 323945-19 -alt 323945-21
description	hose clamp ø 21mm zinc-coated steel Qty 20 pcs		
For models:	AM-10, AM-11, AM-141, AM-700, AM900-10N, AM900-90, AMS900-10N, AMX, AMX-10HL, AMX-90, AMX-E, AMX-ER, AMXR, AMX-R, AMXS, AMXT, AMXTS, AMXX, AMXX-1300, AMXXR, AMXXR-1300, AMXXS, AMXXS-1300, AMXXT, AUP, AUP-90, AUPS, AUX, AUX-E, AUX-ER, AUX-R, AUXX, AUXX-1300, AUXXL, AUXXL-11N, AUXXLS-11N, AUXXR, AUXXR-1300, AUXXS, AUXXS-1300, AUXXT, AUXXTS, ECOMAX-402, ECOMAX-502, ECOMAX-600, ECOMAX-602-10, ECOMAX-602-11, ECOMAX-602S-11, ECOMAX-612-10, ECOMAX-612S-10... (Other models you can see in the webshop)		

2



Part No.	505282	Ref. No.	00-323945-016 323945-16
description	hose clamp ø 16mm zinc-coated steel Qty 20 pcs		
For models:	AM-700, AM900, AMS900, AMX, AMX-900, AMX-E, AMX-ER, AMX-R, AMXR-900, AMXS-900, AMXX-1300, AMXXR-1300, AMXXS-1300, AMXXT, AUX, AUX-E, AUX-ER, AUX-R, AUXX-1300, AUXXL, AUXXR-1300, AUXXS-1300, AUXXT, ECOMAX-402, ECOMAX-502, ECOMAX-600, ECOMAX-650, GC, UX, UXL, UXLS, UXS, UXT, UXTH, UXTHL, UXTHLS, UXTHS, UXTL, UXTLH, UXTLHS, UXTLS, UXTS		

1



Part No.	505285	Ref. No.	00-323945-025 323945-25
description	hose clamp ø 25mm zinc-coated steel Qty 20 pcs		
For models:	AM-10, AM-11, AM-141, AM-700, AM900, AM900-10N, AM900-90, AMS900, AMS900-10N, AMX, AMX-10HL, AMX-90, AMX-900, AMX-E, AMX-ER, AMXR, AMX-R, AMXS, AMXS-900, AMXT, AMXTS, AMXX, AMXX-1300, AMXXR, AMXXR-1300, AMXXS, AMXXS-1300, AMXXT, AUP, AUP-90, AUPS, AUX, AUX-E, AUX-ER, AUX-R, AUXX, AUXX-1300, AUXXL, AUXXL-11N, AUXXLS-11N, AUXXR, AUXXR-1300, AUXXS, AUXXS-1300, AUXXT, AUXXTS, ECOMAX-402, ECOMAX-502, ECOMAX-600... (Other models you can see in the webshop)		

1



Part No.	505283	Ref. No.	00-323945-018 323945-18
description	hose clamp ø 18mm zinc-coated steel Qty 20 pcs		
For models:	AM-10, AM-11, AM-141, AM-700, AM900, AM900-10N, AM900-90, AMS900, AMS900-10N, AMX, AMX-10HL, AMX-90, AMX-900, AMX-E, AMX-ER, AMXR, AMX-R, AMXR-900, AMXS, AMXS-900, AMXT, AMXTS, AMXX, AMXX-1300, AMXXR, AMXXR-1300, AMXXS, AMXXS-1300, AMXXT, AUP, AUP-90, AUPS, AUX, AUX-E, AUX-ER, AUX-R, AUXX, AUXX-1300, AUXXL-11N, AUXXLS-11N, AUXXR, AUXXR-1300, AUXXS, AUXXS-1300, AUXXT, AUXXTS, ECOMAX-402, ECOMAX-502, ECOMAX-600, ECOMAX-602-10... (Other models you can see in the webshop)		

1





Part No.	505286	Ref. No.	00-323945-029 323945-29
description	hose clamp ø 29mm zinc-coated steel Qty 20 pcs		
For models:	AM900-10N, AM900-90, AMS900-10N, AMX, AMX-10HL, AMX-90, AMX-E, AMX-ER, AMXR, AMX-R, AMXS, AMXT, AMXTS, AMXX, AMXX-1300, AMXXR, AMXXR-1300, AMXXS, AMXXS-1300, AMXXT, AUP, AUP-90, AUPS, AUX, AUX-E, AUX-ER, AUX-R, AUXX, AUXX-1300, AUXXL, AUXXL-11N, AUXXLS-11N, AUXXR, AUXXR-1300, AUXXS, AUXXS-1300, AUXXT, AUXXTS, CR, CR-F, ECOMAX-602-11, ECOMAX-602S-11, ECOMAX-612-10, ECOMAX-612S-10, ECOMAX-700, FE, GC, GC11, GC12, GC31... (Other models you can see in the webshop)		





			
1			
Part No.	505287	Ref. No.	00-323945-033 323945-33
description	hose clamp ø 33mm zinc-coated steel Qty 20 pcs		
For models:	AM-700, AM900, AM900-10N, AM900-90, AMS900, AMS900-10N, AMX, AMX-10HL, AMX-90, AMX-900, AMXR, AMXR-900, AMXS, AMXS-900, AMXX, AMXXR, AMXXS, AUP, AUP-90, AUPS, AUXX, AUXXL-11N, AUXXLS-11N, AUXXR, AUXXS, CN-Protronic, CN-Smartronic, CP-Protronic, CR-F, ECOMAX-402, ECOMAX-502, ECOMAX-600, ECOMAX-602-11, ECOMAX-612-10, ECOMAX-612S-10, ECOMAX-650, ECOMAX-700, FX, GC31, GC32, GC41, GC42, GX		

			
1			
Part No.	505293	Ref. No.	00-323945-035 323945-35
description	hose clamp ø 34-38mm zinc-coated steel Qty 20 pcs		
For models:	AM900-10N, AM900-90, AMS900-10N, AMX, AMX-10HL, AMX-90, AMXR, AMXS, AMXT, AMXTS, AMXX, AMXXR, AMXXS, AUP, AUP-90, AUPS, AUXX, AUXXL-11N, AUXXLS-11N, AUXXR, AUXXS, AUXXT, AUXXTS, CR, CR-F, ECOMAX-402, ECOMAX-502, ECOMAX-602-11, ECOMAX-602S-11, ECOMAX-612-10, ECOMAX-612S-10, ECOMAX-650		

			
1			
Part No.	505290	Ref. No.	00-323945-037 323945-37
description	hose clamp ø 37mm zinc-coated steel Qty 10 pcs		
For models:	AM-700, AM900, AMS900, AMX-900, AMXR-900, AMXS-900, AMXT, AMXTS, AMXX-1300, AMXXR-1300, AMXXS-1300, AMXXT, AUXX-1300, AUXXL, AUXXR-1300, AUXXS-1300, AUXXT, AUXXTS, CR, ECOMAX-402, ECOMAX-502, ECOMAX-600, ECOMAX-700, FP, FX, FX-McDonalds, GC41, GC42, GP, GX, UX, UXL, UXLS, UXS, UXT, UXTH, UXTHL, UXTHLS, UXTHS, UXTL, UXTLH, UXTLHS, UXTLS, UXTS		

			
1			
Part No.	505294	Ref. No.	00-323945-053 323945-53
description	hose clamp ø 53mm zinc-coated steel Qty 10 pcs		
For models:	CN-Protronic, CN-Smartronic, CP-Protronic, CSA, CS-Easytronic, ECOMAX-402, ECOMAX-502, FE, GC, GC11, GC12, GC31, GC32, GC41, GC42, HE, HE600-HL, HE-P, UX-30, UX-30B, UX-30E, UX-30EB, UX-30EH, UX-30ES, UX-30ESB, UX-30ESH, UX-30H, UX-30-McDonalds, UX-30S, UX-30SB, UX-30SH, UX-60, UX-60B, UX-60E, UX-60EB, UX-60EH, UX-60EHB, UX-60H, UX-60HB		

			
1			
Part No.	505291	Ref. No.	00-323945-056 323945-56
description	hose clamp ø 56mm zinc-coated steel Qty 10 pcs		
For models:	AM-700, AM900, AMS900, AMX-900, AMXR-900, AMXS-900, CR, ECOMAX-402, ECOMAX-502, ECOMAX-600, ECOMAX-650, FE, HE, HE600-HL, HE-P		

			
1			
Part No.	505289	Ref. No.	00-323945-060 323945-60
description	hose clamp ø 60mm zinc-coated steel Qty 10 pcs		
For models:	AM-10, AM-11, AM-141, AM900-10N, AM900-90, AMS900-10N, AMX, AMX-10HL, AMX-90, AMXR, AMXS, AMXT, AMXTS, AMXX, AMXXR, AMXXS, AUP, AUP-90, AUPS, AUXX, AUXXL-11N, AUXXLS-11N, AUXXR, AUXXS, AUXXT, AUXXTS, CSA, ECOMAX-602-10, ECOMAX-602-11, ECOMAX-602S-11, ECOMAX-612-10, ECOMAX-612S-10		

1

Part No.	505292	Ref. No.	00-323945-064 323945-64
description	hose clamp ø 64-68mm zinc-coated steel Qty 10 pcs		
For models:	AM-10, AM-11, AM-141, AM900-10N, AM900-90, AMS900-10N, AMX, AMX-10HL, AMX-90, AMXR, AMXS, AMXT, AMXTS, AUXXT, AUXXTS, CN-Protronic, CN-Smartronic, CP-Protronic, CS-Easytronic, ECOMAX-602-10, ECOMAX-602-11, ECOMAX-602S-11, ECOMAX-612-10, ECOMAX-612S-10, ECOMAX-700, UX, UXL, UXLS, UXS, UXT, UXTL, UXTLS, UXTS		



retaining rings
DIN 471



1

Part No.	507509	Ref. No.	602302 RR-010-13 RR-10-13 RR-E-2-34
description	retaining ring shaft ø 18mm thickness 1.2mm stainless steel DIN 471		
For models:	103G, 203G, 2226, 303G, AM-12E, AM-12EC, AM-12EF, AM-12ER, AM15, AM15F, AM15T, AM-600, AM-600C, AM-600CR, AM-600R, C44A, C44AW, C54A, C64A, CS-2012E, CS-2022E, CSD-2012E, CSD-2022E, CX, FTT, FTX, FUX, ML-110025, ML-110976, ML-110977, ML-32614, ML-32615, UW-105, UW-135, UW-135H, UWX		

DIN 6799

1

Part No.	518557	Ref. No.	602980
description	retaining ring E D1 ø 5mm D2 ø 11mm SS DIN 6799 thickness 0.7mm		

DIN 7993



1

Part No.	697871	Ref. No.	602309 RR-E-2-38
description	retaining ring A D1 ø 14mm D2 ø 12.8mm spring steel DIN 7993 thickness 1mm		
For models:	AM-12E, AM-12EC, AM-12EF, AM-12ER, AM-600, AM-600C, AM-600CR, AM-600R, FM-400H, FM-400U, FM-500, FM-500H, UW-105, UW-120, UW-125, UW-135, UW-135H, UW-200, UW-205, UW-55		



1

Part No.	518308	Ref. No.	139321-856
description	retaining ring DIN 7993 for drain assembly thickness 3mm ED ø 57mm		

cotter pins



1

Part No.	694269	Ref. No.	602886
description	cotter pin ø 2.7mm L 18mm		
For models:	FTX, FUX, UW-105, UW-125, UW-205		

consumables
fuses
fine fuses



1

Part No.	358666	Ref. No.	926283 E926283
description	fine fuse size ø5x20mm 0.315A fast-acting rated 250V Qty 10 pcs		



1

Part No.	358530	Ref. No.	139321-902
description	fine fuse size ø5x20mm 0.8A fast-acting rated 250V Qty 10 pcs		



1

Part No.	358677	Ref. No.	139321-690 E228004
description	fine fuse size ø5x20mm 4A fast-acting rated 250V Qty 10 pcs		



1

Part No.	358594	Ref. No.	228012
description	fine fuse size ø5x20mm 0.16A slow-acting rated 250V Qty 10 pcs		



			
1			
Part No.	358606	Ref. No.	228010 E228010
description	fine fuse size ø5x20mm 4A slow-acting rated 250V Qty 10 pcs		

ø6.3x32mm 250V

			
1			
Part No.	358792	Ref. No.	H3090506
description	fine fuse size ø6.3x32mm 10A slow-acting rated 250V Qty 10 pcs		

			
1			
Part No.	358644	Ref. No.	228011
description	fine fuse size ø6.3x32mm 2A slow-acting rated 250V Qty 10 pcs		

ø6.3x32mm 500V

			
1			
Part No.	358742	Ref. No.	775570-2
description	fine fuse size ø6.3x32mm 0.8A fast-acting rated 500V Qty 10 pcs		

			
1			
Part No.	358752	Ref. No.	3090506
description	fine fuse size ø6.3x32mm 10A fast-acting rated 500V Qty 10 pcs		

			
1			
Part No.	358751	Ref. No.	00-775570-001 775570-1
description	fine fuse size ø6.3x32mm 6.3A fast-acting rated 500V Qty 10 pcs		
For models:	AMX-900, AMXS-900, AMXX-1300, AMXXT, AUXX-1300, AUXXT, ECOMAX-650, UX, UXL, UXLS, UXS, UXT, UXTH, UXTHL, UXTHLS, UXTHS, UXTL, UXTLS, UXTS		

fine fuse holders

			
1			
Part No.	550519	Ref. No.	139321-601
description	cover plate suitable fuseA ratedV connection for fuse holder		

GASTROPARTS.COM

