



GASTROPARTS

Henkelman

- [EN]** Equipment
- [DE]** Geräte
- [ES]** Aparatos
- [FR]** Équipement
- [IT]** Attrezzature
- [PL]** Urządzenia
- [RU]** Оборудование

✉ gastroparts@gastroparts.com

☎ +48 56 657 00 66

📘 fb.com/gastroparts.global

GASTROPARTS.COM





heating elements

accessories

washers



Part No.	560333	Ref. No.	0010026
description	plain washer ID ø 6.4mm ED ø 12mm thickness 1.6mm SS Qty 1 pcs DIN 125A for thread M6		
For models:	Boxer42, Boxer42XL, DT100, DT60, Falcon2-60, Falcon2-70, Falcon52, Falcon80, H220, H220-2, H220-A, H220-A-2, H300-1, H300-2, H300-A-1, H300-A-2, H300-AA, H300-RVS, H400-AA, H400-RVS, H500, H600, H700, H800, Lynx32, Lynx42, Marlin42XL, Marlin46, Marlin52, Marlin90, Polar2-40, Polar2-50, Polar2-75, Polar2-85, Polar2-95, Polar52, Polar80, Toucan42, Vortex		



Part No.	560113	Ref. No.	0010026
description	plain washer ID ø 6.4mm ED ø 12mm thickness 1.6mm SS Qty 20 pcs DIN 125A for thread M6		

switches and momentary switches

rocker/momentary rocker switches

28x13.5mm



Part No.	347039	Ref. No.	0220010
description	rocker switch mounting measurements 27.4x12.4mm black/orange 2NO 250V 16A illuminated O connection male faston 6.3mm ambient temperature max. 100/55°C protection IP40		
For models:	JumboPlus, MiniJumbo		

microswitches

lever actuated



Part No.	347033	Ref. No.	0900461
description	microswitch with lever 250V 10A 1CO connection with cable L 38mm ambient temperature max. 85°C mounting distance 16mm actuating force: 60g lever length 40mm		
For models:	Polar2-40, Polar2-50, Polar2-75, Polar2-85, Polar2-95, Polar80		

Part No.	347032	Ref. No.	0900460
description	microswitch with lever 250V 10A 1NO connection with cable L 40mm ambient temperature max. 85°C actuating force: 10g		
For models:	Falcon52, Falcon80, JumboPlus, Marlin46, Marlin90, MiniJumbo, Polar2-40, Polar2-50, Polar2-75, Polar2-85, Polar2-95, Polar52		

Part No.	347035	Ref. No.	0900466
description	microswitch with lever 30V 1A 1CO connection with cable L 25mm ambient temperature max. 85°C type D2FW-G 271M actuating force: 80g lever length 21mm		
For models:	Falcon2-60, Falcon2-70, Polar2-40, Polar2-50, Polar2-75, Polar2-85, Polar2-95		

Part No.	347034	Ref. No.	0900465
description	microswitch with lever 30V 1A 1NO connection with cable L 18mm ambient temperature max. 85°C type D2FW-G 271M actuating force: 100g lever length 25mm		
For models:	Boxer35, Boxer42, Boxer42XL, Boxer52, Boxer62, Falcon2-60, Falcon2-70, Falcon52, Falcon80, Jumbo30, Jumbo35, Jumbo42, Jumbo50, JumboPlus, Lynx32, Lynx42, Marlin42, Marlin42XL, Marlin46, Marlin52, Marlin90, MiniJumbo, Polar2-40, Polar2-50, Polar2-75, Polar2-85, Polar2-95, Polar52, Polar80, Toucan42		

float switches

Part No.	348087	Ref. No.	0220114
description	float switch length external size 110mm thread 1/8" 1NC/Temp ø 30mm L 110mm mounting ø 10mm 300V 0.5A cable, 4-wire cable length 1600mm with temperature probe		
For models:	DT100, DT60		



rotary switches

producer-specific rotary switches

DIHR / KROMO

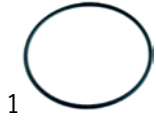

Part No.	345896	Ref. No.	0065736 0065788
description	O-ring EPDM thickness 1.5mm ID ø 37mm Qty 1 pcs		
For models:	Falcon2-60, Falcon2-70, Polar2-40, Polar2-50		

miscellaneous



Part No.	347040	Ref. No.	0220060
description	rotary switch sets of contacts 3 2 0-1 momentary type 400V 32A shaft ø 5x5mm shaft Lmm connection screw		
For models:	Falcon2-60, Falcon52, Falcon80, Marlin46, Marlin52, Marlin90, Polar2-40, Polar2-50, Polar2-75, Polar2-85, Polar2-95, Polar52, Polar80		

accessories

levers



Part No.	347041	Ref. No.	0220065
description	knob 2 0-1 typeVA shaft ømm shaft Lmm connection for rotary switch		
For models:	DT100, DT60, Falcon2-60, Falcon2-70, Falcon52, Falcon80, Marlin46, Marlin52, Marlin90, Polar2-40, Polar2-50, Polar2-75, Polar2-85, Polar2-95, Polar52, Polar80, Vortex		

control equipment

ABB

ø22mm

switches (complete)



Part No.	347153	Ref. No.	0220006
description	push switch mounting measurements ø22mm black 2NO 300V 5A connection screw ambient temperature max. 85°C protection IP40		
For models:	Boxer35, Boxer42, Boxer42XL, Boxer52, Boxer62, Falcon2-60, Falcon2-70, Falcon52, Falcon80, Jumbo30, Jumbo35, Jumbo42, Jumbo42XL, Jumbo50, JumboPlus, Marlin42XL, Marlin46, Marlin52, Marlin90, MiniJumbo, Polar2-40, Polar2-50, Polar2-75, Polar2-85, Polar2-95, Polar52, Polar80, Toucan42, Vortex		

GEV special

ø22mm

switches (complete)



Part No.	347036	Ref. No.	0220017
description	push switch mounting measurements ø22mm 2NO 230V main switch clear connection screw 6A protection IP40 ambient temperature max. 55°C		
For models:	DT100, DT60, H100, H150, H200, H200-2, H200-A, H200-A-2, H200-XL, H200-XL-2, H220, H220-2, H220-A, H220-A-2, H300-1, H300-2, H300-A-1, H300-A-2, H300-AA, H300-RVS, H400-AA, H400-RVS, H500, H600, H700, H800		
accessories for	347036		
	Part No.	347038	Ref. No. 0220042
	protection cap for pressure switch		

button plates



Part No.	347038	Ref. No.	0220042
description	protection cap for pressure switch		
For models:	H100, H150, H200, H200-2, H200-A, H200-A-2, H200-XL, H200-XL-2, H220, H220-2, H220-A, H220-A-2, H300-1, H300-2, H300-A-1, H300-A-2, H300-AA, H300-RVS, H400-AA, H400-RVS, H500, H600, H700, H800		

miscellaneous



Part No.	347037	Ref. No.	0220005
description	push switch mounting measurements ø22mm black 2NO 10A		
For models:	Boxer35, Boxer42, Boxer42XL, Falcon2-60, Falcon2-70, Falcon52, Falcon80, Jumbo35, Jumbo42, JumboPlus, Marlin42, Marlin42XL, Marlin46, Marlin52, Marlin90, MiniJumbo, Polar2-40, Polar2-50, Polar2-75, Polar2-85, Polar2-95, Polar52, Polar80		



contactors

LOVATO

power contactors



1

Part No.	381102	Ref. No.	0221005 0221007
description	power contactor resistive load 20A 24VAC (AC3/400V) 9A/4kW main contacts 4NO auxiliary contacts connection screw connection type 11BG09T4A24		
For models:	Boxer35, Boxer42, Boxer42XL, Boxer52, Boxer62, H100, Jumbo42XL, Lynx32, Lynx42, Marlin42, Marlin42XL, Vortex		



1

Part No.	380525	Ref. No.	0221108
description	power contactor resistive load 25A 230VAC (AC3/400V) 9A/4.2kW main contacts 4NO auxiliary contacts connection screw connection type BF09T4A230		
For models:	DT60, Marlin42XL		



1

Part No.	381103	Ref. No.	0221006 0221106
description	power contactor resistive load 25A 24VAC (AC3/400V) 9A/4.2kW main contacts 4NO auxiliary contacts connection screw connection type BF09T4A024		
For models:	Falcon2-60, Falcon2-70, Falcon52, Falcon80, H100, H150, H200, H200-2, H200-A, H200-A-2, H200-XL, H200-XL-2, H220, H220-2, H220-A, H220-A-2, H300-1, H300-2, H300-A-1, H300-A-2, H300-AA, H300-RVS, H400-AA, H400-RVS, H500, H600, H700, H800, Marlin46, Marlin52, Marlin90, Polar2-40, Polar2-50, Polar2-75, Polar2-85, Polar2-95, Polar52, Polar80		

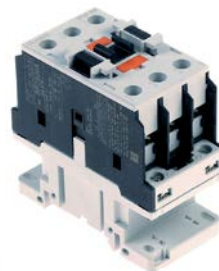

1

Part No.	380722	Ref. No.	0221013
description	power contactor resistive load 56A 230VAC (AC3/400V) 32A/16kW main contacts 3NO auxiliary contacts connection screw connection type BF3200A230		
For models:	DT100, DT60		

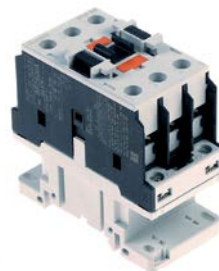

1

Part No.	381104	Ref. No.	0221112
description	power contactor resistive load 56A 24VAC (AC3/400V) 32A/16kW main contacts 3NO auxiliary contacts connection screw connection type BF3200A024		
For models:	Polar2-75, Polar2-85, Polar2-95		

overload switches



1

Part No.	381099	Ref. No.	0221133
description	overload switch setting range 13-18A for contactors BF (09-38) series connection screw		
For models:	Polar2-85, Polar2-95		





1

Part No.	381100	Ref. No.	0221134
description	overload switch setting range 17-23A for contactors BF (09-38) series connection screw		



			
1			
Part No.	380753	Ref. No.	0221123
description	overload switch setting range 2.5-4A for contactors BF (09-38) series connection screw		

			
1			
Part No.	381101	Ref. No.	0221136
description	overload switch setting range 24-32A for contactors BF (09-38) series connection screw		
For models:	Polar2-95		

			
1			
Part No.	380754	Ref. No.	0221124
description	overload switch setting range 4-6.5A for contactors BF (09-38) series connection screw		
For models:	DT60, Falcon2-60, Falcon2-70, Falcon52, Falcon80, Marlin52, Marlin90, Polar2-40, Polar2-50, Polar52		

			
1			
Part No.	381097	Ref. No.	0221129
description	overload switch setting range 6.3-10A for contactors BF (09-38) series connection screw		
For models:	Polar2-40		

			
1			
Part No.	381098	Ref. No.	0221130
description	overload switch setting range 9-14A for contactors BF (09-38) series connection screw		

transformers

open transformers

with clamp terminal

			
1			
Part No.	403683	Ref. No.	0223017
description	transformer primary 220 secondary 10 500VA Mini Jumbo/ Jumbo35 / Boxer35		
For models:	JumboPlus, Lynx32, MiniJumbo		

			
1			
Part No.	403684	Ref. No.	0223019
description	transformer primary 220 secondary 15 700VA Boxer 42		
For models:	Boxer52, Lynx32, Lynx42		

			
1			
Part No.	402080	Ref. No.	0223026
description	transformer primary 220/380VAC secondary 0-20VAC 600VA connection screw connection 50/60Hz		
For models:	Falcon2-60, Marlin46, Marlin90		





			
1			
Part No.	402081	Ref. No.	0223032
description	transformer primary 220/380VAC secondary 0-21.4VAC 900VA connection screw connection 50/60Hz		
For models:	Falcon2-70, Falcon52, Falcon80, Jumbo50, Marlin52, Marlin90, Polar2-40, Polar2-50, Polar2-75, Polar2-85, Polar2-95, Polar80		

			
1			
Part No.	402083	Ref. No.	0223042
description	transformer primary 380/400VAC secondary 0-46VAC 1150VA connection screw connection 50/60Hz		
For models:	Polar2-95		

			
1			
Part No.	402086	Ref. No.	0223011 0223011001
description	transformer primary 230/400VAC secondary 0-9/0-24VAC 64.5VA connection screw 50/60Hz		
For models:	Boxer35, Boxer42, Boxer42XL, Boxer52, Boxer62, Falcon2-60, Falcon2-70, Falcon52, Falcon80, H100, H150, H200, H200-2, H200-A, H200-A-2, H200-XL, H200-XL-2, H220, H220-2, H220-A, H220-A-2, H300-1, H300-2, H300-A-1, H300-A-2, H300-AA, H300-RVS, H400-AA, H400-RVS, H500, H600, H700, H800, Jumbo30, Jumbo35, Jumbo42, JumboPlus, Lynx32, Lynx42, Marlin42, Marlin42XL, Marlin46, Marlin52, Marlin90, MiniJumbo, Polar2-40, Polar2-50, Polar2-75, Polar2-85, Polar2-95...(Other models you can see in the webshop)		

encapsulated transformers			
multiple connections			
			
1			
Part No.	402085	Ref. No.	0223004
description	transformer primary 230VAC secondary 24VAC 30VA secondary 1.25A connection male faston 6.3mm 50/60Hz type 65.16.230.323.224.05		
For models:	Jumbo30, Jumbo35, Jumbo42, Jumbo42XL, Jumbo50, JumboPlus, MiniJumbo		

			
1			
Part No.	402084	Ref. No.	0223049
description	transformer primary 380/400VAC secondary 0-24VAC 1150VA connection screw connection 50/60Hz		
For models:	Marlin90, Polar2-40, Polar2-50, Polar2-75		

electronics			
PCBs			
			
1			
Part No.	402000	Ref. No.	0230000
description	PCB suitable for JUMBO analog		
For models:	JumboPlus, MiniJumbo		

			
1			
Part No.	402082	Ref. No.	0223035
description	transformer primary 380/400VAC secondary 0-33,1VAC 1150VA connection screw connection 50/60Hz		
For models:	Falcon80, Polar2-75, Polar2-85, Polar2-95, Polar80		

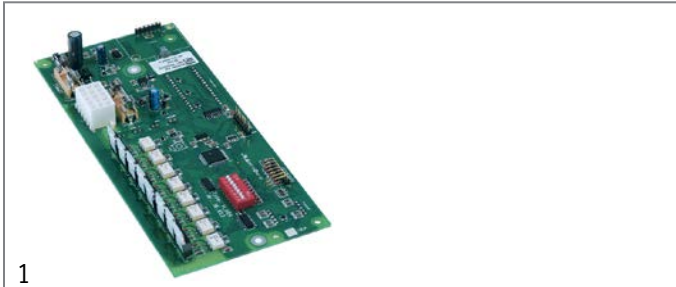

1

Part No.	402093	Ref. No.	0230020 0230040
description	PCB vacuum packing machine B35 / B-M 42/42XL H_HD4		
For models:	Boxer35, Boxer42, Boxer42XL, Boxer52, Boxer62, Falcon2-60, Falcon2-70, Falcon52, Falcon80, H100, H150, H200, H200-2, H200-A, H200-A-2, H200-XL, H200-XL-2, H220, H220-2, H220-A, H220-A-2, H300-1, H300-2, H300-A-1, H300-A-2, H300-AA, H300-RVS, H400-AA, H400-RVS, H500, H600, H700, H800, Marlin42, Marlin42XL, Marlin46, Marlin52, Marlin90, Polar2-40, Polar2-50, Polar2-75, Polar2-85, Polar2-95, Polar52, Polar80, Toucan42		

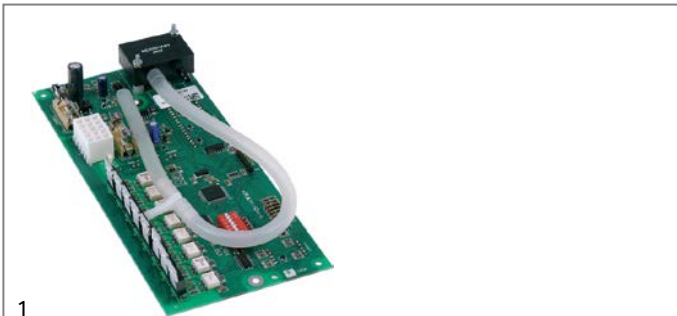

1

Part No.	402095	Ref. No.	0230042
description	PCB vacuum packing machine B35 / B-M 42/42XL H_HD4 with sensor		
For models:	Boxer35, Boxer42, Boxer42XL, Boxer52, Boxer62, Falcon2-60, Falcon2-70, Falcon52, Falcon80, Marlin42, Marlin42XL, Marlin46, Marlin52, Marlin90, Polar2-40, Polar2-50, Polar2-75, Polar2-85, Polar2-95, Polar52, Polar80, Toucan42		

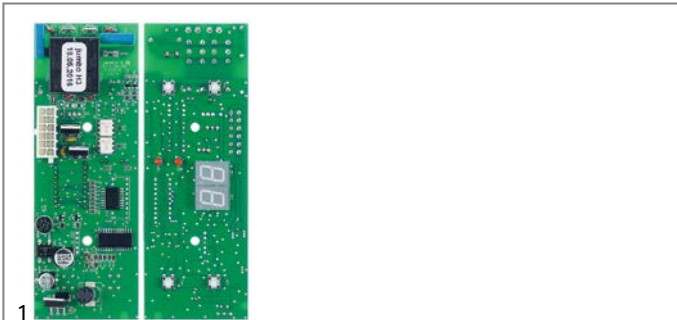

1

Part No.	402092	Ref. No.	0230036
description	PCB vacuum packing machine JUMBO		
For models:	Jumbo35, Jumbo42, Jumbo42XL, Jumbo50, JumboPlus, MiniJumbo		

keypads

membrane keypads



1

Part No.	402098	Ref. No.	0810018 0810052 + 0330110 0900102 8000400
description	membrane keypad vacuum packing machine B35-16 with frame		
For models:	H100, H150, H200, H200-2, H200-A, H200-A-2, H200-XL, H200-XL-2, H220, H220-2, H220-A, H220-A-2, H300-1, H300-2, H300-A-1, H300-A-2, H300-AA, H300-RVS, H400-AA, H400-RVS, H500, H600, H700, H800		

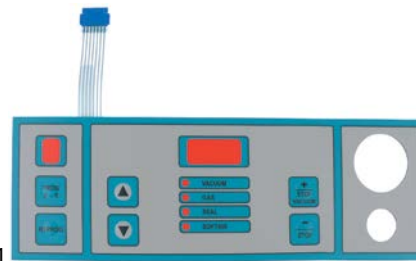



1

Part No.	402094	Ref. No.	0810050
description	membrane keypad vacuum packing machine H100		
For models:	H100, H150, H200, H200-2, H200-A, H200-A-2, H200-XL, H200-XL-2, H220, H220-2, H220-A, H220-A-2, H300-1, H300-2, H300-A-1, H300-A-2, H300-AA, H300-RVS, H400-AA, H400-RVS, H500, H600, H700, H800		





1

Part No.	402097	Ref. No.	0330105 0900101 8000102
description	membrane keypad vacuum packing machine JUMBO complete		
For models:	Jumbo35, Jumbo42, JumboPlus, MiniJumbo		
spare parts for	402097		
	Part No.	347153	Ref. No. 0220006
	push switch mounting measurements ø22mm black 2NO 300V 5A connection screw ambient temperature max. 85°C protection IP40		
	Part No.	402092	Ref. No. 0230036
	PCB vacuum packing machine JUMBO		
	Part No.	541528	Ref. No. 0810101
	manometer ø 40mm pressure range 0 up to 1bar connection angled connection ø 5mm		





			
1			
Part No.	402099	Ref. No.	0900104 8000401
description	membrane keypad vacuum packing machine with frame		

			
1			
Part No.	402100	Ref. No.	0900105
description	membrane keypad vacuum packing machine with frame		
For models:	Falcon2-60, Falcon2-70, Falcon52, Falcon80, Marlin46, Marlin52, Marlin90, Polar2-40, Polar2-50, Polar2-85, Polar2-95, Polar52		

			
1			
Part No.	402096	Ref. No.	0900100
description	membrane keypad with frame		
For models:	Jumbo30, Jumbo35, Jumbo42, Jumbo42XL, Jumbo50, JumboPlus, MiniJumbo		

control panel

			
1			
Part No.	504870	Ref. No.	8001900
description	control panel vacuum packing machine H100 L 355mm grey H 155mm D 50mm		

			
1			
Part No.	692175	Ref. No.	0330124 0600000
description	front panel vacuum packing machine JUMBO L 293mm W 91mm thickness 34mm analogue		
For models:	JumboPlus, MiniJumbo		

			
1			
Part No.	692142	Ref. No.	0065110 0330120
description	housing vacuum packing machine 200/220		
For models:	Falcon2-60, Falcon2-70, Falcon52, Falcon80, H100, H150, H200, H200-2, H200-A, H200-A-2, H200-XL, H200-XL-2, H220, H220-2, H220-A, H220-A-2, H300-1, H300-2, H300-A-1, H300-A-2, H300-AA, H300-RVS, H400-AA, H400-RVS, H500, H600, H700, H800, Lynx32, Lynx42, Polar2-40, Polar2-50, Polar2-75, Polar2-85, Polar2-95, Polar52, Polar80, Vortex		

			
1			
Part No.	692068	Ref. No.	0600020 0600020000
description	switch panel vacuum packing machine JUMBO Combivac L 258mm W 55mm thickness 2.3mm		

			
1			
Part No.	692069	Ref. No.	0600011 0600011000
description	switch panel vacuum packing machine JUMBO L 288mm W 88mm thickness 20mm digital		

			
1			
Part No.	692168	Ref. No.	8000100
description	switch panel vacuum packing machine JUMBO L 289mm W 91mm thickness 20mm		



solenoid valves

solenoid valves (water)

metal

ASCO

2-way



1

Part No.	370509	Ref. No.	0280040 0280042
description	solenoid valve 2-ways 24VAC inlet 1/2" outlet 1/2" connection 1/2" L 52mm DN 12.5mm slide-on receptacle DIN -20° up to 85°C membranes NBR (water) p max 7bar 1/2" brass		
For models:	Boxer62, Falcon2-60, Falcon2-70, Falcon52, Falcon80, H300-1, H300-2, H300-A-1, H300-A-2, H300-AA, H300-RVS, H400-AA, H400-RVS, H500, H600, H700, H800, Marlin46, Marlin52, Marlin90, Polar2-40, Polar2-50, Polar2-75, Polar2-85, Polar2-95, Polar52, Polar80, Vortex		

3-way



1

Part No.	370510	Ref. No.	0280052
description	solenoid valve brass 3-ways 24VAC connection 1/4" L 43mm DN 4.4mm -20 up to +90°C membranes NBR (water) p max 3bar p min 0bar 1/4"		
For models:	Falcon2-60, Falcon2-70, Falcon80, Polar2-40, Polar2-50, Polar2-75, Polar2-85, Polar2-95, Polar52, Polar80		

Solenoid valve - accessories



1

Part No.	370516	Ref. No.	0280072
description	nut thread M8x0.75 for solenoid coil		
For models:	Boxer35, Boxer42, Boxer42XL, Boxer42XL-BA, Jumbo35, Jumbo42, JumboPlus, MiniJumbo		



1

Part No.	370515	Ref. No.	0280071
description	solenoid coil 24V voltage AC seat ø 9mm		
For models:	Boxer35, Boxer42, Boxer42XL, Boxer42XL-BA, H300-1, H300-2, H300-A-1, H300-A-2, H300-AA, H300-RVS, H800, Jumbo35, Jumbo42, JumboPlus, Lynx32, Lynx42, Marlin52, MiniJumbo, Polar2-75, Polar2-85, Polar2-95		



1

Part No.	370508	Ref. No.	0280024
description	solenoid coil 3-way 24V 6mm		
For models:	JumboPlus, MiniJumbo		



1

Part No.	370517	Ref. No.	0280075
description	solenoid valve body nominal dimension 2.8mm		
For models:	Boxer35, Boxer42, Boxer42XL, Boxer42XL-BA, JumboPlus, MiniJumbo		



1

Part No.	370519	Ref. No.	0280080
description	solenoid valve body nominal dimension 2.8mm		
For models:	Boxer35, Boxer42, Boxer42XL, Boxer42XL-BA, Jumbo35, Jumbo42, JumboPlus, MiniJumbo		





1

Part No.	370518	Ref. No.	0280078
description	solenoid valve body nominal dimension 6mm		
For models:	Boxer35, Boxer42, Boxer42XL, Boxer42XL-BA, Jumbo35, Jumbo42, Lynx32, Lynx42		





solenoid valves for vacuum machines

 <p>1</p>			
Part No.	370520	Ref. No.	0900858
description	solenoid valve 2-way 24VACV inlet 1/4"mm outlet ø4 vacuum packing machine		

 <p>1</p>			
Part No.	370507	Ref. No.	0280021
description	solenoid valve 2-ways 24VAC inlet 1/8" outlet 1/8"mm L 31mm DN 3.3mm 1/8" brass		
For models:	Boxer35, Boxer42, Boxer42XL, Falcon2-60, Falcon2-70, Falcon52, Falcon80, H100, Lynx32, Lynx42, Marlin42, Marlin42XL, Marlin46, Marlin52, Marlin90, Polar2-40, Polar2-50, Polar2-75, Polar2-85, Polar2-95, Polar52, Polar80, Toucan42		

 <p>1</p>			
Part No.	370506	Ref. No.	0280010
description	solenoid valve 3-ways 24VAC inlet 1/8" outlet 1/8"mm L 35mm body inner cone DN 2.8mm 1/8" 24V brass		
For models:	Falcon52, H300-A-1, H300-A-2, H300-AA, H300-RVS, H500, H700, Marlin46, Marlin52, Marlin90		

 <p>1</p>			
Part No.	370514	Ref. No.	0280029
description	solenoid valve assembly 24VAC inlet 1/2" 3 coils coil type VA12 24V thread 1/2" hose ø 21mm H200+SA		
For models:	Boxer35		

 <p>1</p>			
Part No.	370513	Ref. No.	0280027
description	solenoid valve assembly 24VAC inlet 1/2" outlet 10.5mm 2 coils coil type VA12 thread 1/2" JP		
For models:	JumboPlus		

 <p>1</p>			
Part No.	370800	Ref. No.	0280035
description	solenoid valve assembly 24VAC inlet 1/2" outlet 10.5mm 2 coils coil type VA12 thread 1/2" JP		

 <p>1</p>			
Part No.	370512	Ref. No.	0280026 (old version)
description	solenoid valve assembly 24VAC inlet 1/2" outlet 21mm 2 coils coil type VA12 24V thread 1/2" hose ø 21mm J35/J42/B35		

 <p>1</p>			
Part No.	370816	Ref. No.	0280026
description	solenoid valve assembly 24VAC inlet 1/2" outlet 21mm 2 coils coil type VA12 24V thread 1/2" hose ø 21mm J35/J42/B35		
For models:	Boxer35, Boxer42, Boxer42XL, H100, Jumbo35, Jumbo42, Marlin42, Marlin42XL		

 <p>1</p>			
Part No.	370511	Ref. No.	0280025
description	solenoid valve assembly 24VAC inlet 1/2" outlet 7.5mm 2 coils coil type VA12 thread 1/2" MJ		
For models:	JumboPlus, MiniJumbo		





			
1			
Part No.	370787	Ref. No.	0280039
description	solenoid valve assembly 24VAC inlet 1/2" outlet 7.5mm 2 coils coil type VA12 thread 1/2" MJ		

			
1			
Part No.	370503	Ref. No.	0900833
description	solenoid valve assembly thread 1/2" hose ø 21mm 24V coil type VA12 J42		

			
1			
Part No.	370505	Ref. No.	0900836
description	solenoid valve assembly 3 coils 24V thread 1/2" hose ø 21mm coil type VA12 B42(XL)+SA		

			
1			
Part No.	692064	Ref. No.	0280032 0280032000
description	solenoid valve assembly thread 1/2" hose ø 6mm 24V H200		
For models:	H100, H150, H200, H200-2, H200-A, H200-A-2, H200-XL, H200-XL-2, H220, H220-2, H220-A, H220-A-2		

			
1			
Part No.	370501	Ref. No.	0900831
description	solenoid valve assembly thread 1/2" hose ø 10mm 24V coil type VA12 JP		

			
1			
Part No.	370500	Ref. No.	0900830
description	solenoid valve assembly thread 1/2" hose ø 7.5mm 24V coil type VA12 MJ		

			
1			
Part No.	370504	Ref. No.	0900835
description	solenoid valve assembly thread 1/2" hose ø 21mm 24V coil type VA12 B35+SA 3 coils		

			
1			
Part No.	370502	Ref. No.	0900832
description	solenoid valve assembly thread 1/2" hose ø 21mm 24V coil type VA12 J35		

fans

hot air motors

			
1			
Part No.	601497	Ref. No.	0939130
description	fan wheel for motor cooling ø 206mm		



pumps

vacuum pumps

vacuum pumps



1

Part No.	500990	Ref. No.	0431600 0431600001
description	vacuum pump 16m ³ /h 230V 0.55kW 50Hz type KB 0016 E 3Z0		
For models:	Boxer35, Jumbo35, Jumbo42, Jumbo42XL, Jumbo50, Lynx42		
spare parts for	500990		
	Part No.	691537	Ref. No. 0939003 0939163
	oil separator filter flow rate 16m ³ /h ø 52mm L 120mm		



1

Part No.	500987	Ref. No.	0430100 0430130 0430130000
description	vacuum pump 4m ³ /h 230V 0.1kW 50Hz type PB 0004 B 000		
For models:	MiniJumbo		
spare parts for	500987		
	Part No.	500988	Ref. No. 0438010
	level glass thread 1/2" plastic		



1

Part No.	499006	Ref. No.	0431300 old version 04313000
description	vacuum pump 8m ³ /h 220/240V 0.35kW 50/60Hz type PB0008		
For models:	Jumbo30		



1

Part No.	499346	Ref. No.	0431300
description	vacuum pump 8m ³ /h 220-240V 0.55/0.66kW 50/60Hz type J21TV513		
For models:	JumboPlus, Lynx32		

rotor vanes

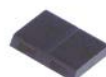

1

Part No.	691992	Ref. No.	0939056
description	rotor vane for vacuum pumps L 20mm W 14mm H 3mm		



1

Part No.	691585	Ref. No.	0939065
description	rotor vane L 100mm W 40mm H 4mm		



1

Part No.	692070	Ref. No.	0939054 0939054000
description	rotor vane L 28mm W 14mm H 3mm		



1

Part No.	691584	Ref. No.	0939060
description	rotor vane L 70mm W 18mm H 4mm		

level glasses



1

Part No.	691563	Ref. No.	0438015
description	level glass thread 1"		
For models:	H800, Polar2-75, Polar2-85, Polar2-95		



1

Part No.	691561	Ref. No.	0438000
description	level glass thread 1/2"		
For models:	H220, H220-2, H220-A, H220-A-2, MiniJumbo		



1

Part No.	500988	Ref. No.	0438010
description	level glass thread 1/2" plastic		
For models:	JumboPlus, MiniJumbo		



1

Part No.	691562	Ref. No.	0438005
description	level glass thread 3/4"		
For models:	Boxer35, Boxer42, Boxer42XL, Boxer62, Falcon2-60, Falcon2-70, Falcon52, Falcon80, H300-1, H300-2, H300-A-1, H300-A-2, H300-AA, H300-RVS, H400-AA, H400-RVS, H600, Jumbo35, Jumbo42, Jumbo50, Lynx42, Marlin42, Marlin42XL, Marlin46, Marlin52, Marlin90, Polar2-40, Polar2-50, Polar52, Polar80		

electric accessories

terminals and connectors

not insulated

male fastons



1

Part No.	699267	Ref. No.	0200090
description	male faston size 6.3mm with bore brass hole ø 4mmmm		
For models:	Boxer35, Boxer42, Boxer42XL, Boxer42XL-BA, Boxer52, Boxer62, H100, H150, H200, H200-2, H200-A, H200-A-2, H200-XL, H200-XL-2, H220, H220-2, H220-A, H220-A-2, H300-1, H300-2, H300-A-1, H300-A-2, H300-AA, H300-RVS, H400-AA, H400-RVS, H500, H600, H700, H800, Jumbo30, Jumbo35, Jumbo42, Jumbo42XL, Jumbo50, JumboPlus, Lynx32, Lynx42, Marlin42, Marlin42XL, Marlin46, Marlin52, Marlin90, MiniJumbo		

electronic components

software

service sets

1

Part No.	401862	Ref. No.	0940306
description	service kit suitable for Henkelman Max Falcon/Polar		

1

Part No.	401858	Ref. No.	0940302
description	service kit suitable for Henkelman Max Jumbo/Boxer		

1

Part No.	401860	Ref. No.	0940304
description	service kit suitable for Henkelman Max Marlin/Falcon/Polar		

1

Part No.	401861	Ref. No.	0940305
description	service kit suitable for Henkelman Min Falcon/Polar		

1

Part No.	401857	Ref. No.	0940301
description	service kit suitable for Henkelman Min Jumbo/Boxer		



1

Part No.	401859	Ref. No.	0940303
description	service kit suitable for Henkelman Min Marlin/Falcon/Polar		

equipment-specific units

for vacuum packers

connection pieces



1

Part No.	699264	Ref. No.	0262200
description	connecting fitting L 71mm 2" hose ø 50mm WS 55		
For models:	H800, Polar2-75, Polar2-85, Polar2-95		

air valves



1

Part No.	691551	Ref. No.	0281005
description	air valve connection 1" 24VAC		
For models:	Falcon2-60, Falcon2-70, Falcon80, H300-1, H300-2, H300-A-1, H300-A-2, H300-AA, H300-RVS, H500, H600, H700, Marlin46, Marlin52, Marlin90, Polar2-40, Polar2-50, Polar52, Polar80		



1

Part No.	691555	Ref. No.	0900852
description	air valve connection 1 1/4"		



1

Part No.	691553	Ref. No.	0281025
description	air valve connection 2"		
For models:	H800, Polar2-75, Polar2-85, Polar2-95		
spare parts for	691553		
	Part No.	691573	Ref. No. 0931205
	maintenance set for air valve size 2"		

lids



1

Part No.	692242	Ref. No.	0600100
description	lid L 378mm W 315mm H 20mm JUMBO		
For models:	JumboPlus, MiniJumbo		



1

Part No.	691586	Ref. No.	0900738
description	lid L 670mm W 670mm H 300 II		



1

Part No.	692062	Ref. No.	0620010 0620010000 0620011
description	lid with gasket L 475mm W 460mm H 75mm B42/J42/H-200		
For models:	Boxer42, H200, H200-2, H200-A, H200-A-2, H220, H220-2, H220-A, H220-A-2, Jumbo42, Marlin42		



air cylinders

air cylinders



1

Part No.	691547	Ref. No.	0286015
description	air cylinder ø 110mm H 47mm shaft length 29mm		
For models:	H300-1, H300-2, H300-A-1, H300-A-2, Jumbo50, Marlin46, Marlin52		



1

Part No.	691548	Ref. No.	0286017
description	air cylinder ø 110mm H 47mm shaft length 29mm		
For models:	Boxer42XLBA, Marlin52, Toucan42		



1

Part No.	691549	Ref. No.	0286020
description	air cylinder ø 110mm shaft length 47mm		
For models:	Marlin46, Marlin90		



1

Part No.	691544	Ref. No.	0286000
description	air cylinder ø 50mm H 25mm		
For models:	JumboPlus, MiniJumbo		



1

Part No.	691545	Ref. No.	0286005
description	air cylinder ø 80mm H 30mm		
For models:	JumboPlus, MiniJumbo		



1

Part No.	691546	Ref. No.	0286010
description	air cylinder ø 80mm H 48mm		
For models:	Boxer42, Boxer42XL, Boxer42XL-BA, H200, H200-2, H200-A, H200-A-2, H200-XL, H200-XL-2, H220, H220-2, H220-A, H220-A-2, Jumbo42, Jumbo42XL, Marlin42, Marlin42XL, Marlin90, Toucan42		

spare parts for 691546



Part No.	691581	Ref. No.	0931405
description	membrane ø 80mm H 24mm		

accessories



1

Part No.	699265	Ref. No.	0287050 0330162
description	nut ø 44mm H 10mm ID ø 22.5mm		
For models:	Boxer35, Boxer42, Boxer42XL, Boxer52, H100, H150, H200, H200-2, H200-A, H200-A-2, H200-XL, H200-XL-2, H220, H220-2, H220-A, H220-A-2, H300-1, H300-2, H300-A-1, H300-A-2, Jumbo30, Jumbo35, Jumbo42, Jumbo42XL, Jumbo50, JumboPlus, Marlin42, Marlin42XL, Marlin46, Marlin52, Marlin90, MiniJumbo		



1

Part No.	699266	Ref. No.	0287030
description	valve support ø 58mm H 8mm ID ø 25mm		
For models:	Boxer42, Boxer42XL, Boxer42XL-BA, Falcon2-60, Falcon2-70, Falcon80, H100, H150, H200, H200-2, H200-A, H200-A-2, H200-XL, H200-XL-2, H220, H220-2, H220-A, H220-A-2, H300-1, H300-2, H300-A-1, H300-A-2, H300-AA, H300-RVS, Jumbo42, Marlin42, Marlin42XL, Marlin46, Marlin52, Marlin90, Polar2-40, Polar2-50, Polar2-75, Polar2-85, Polar2-95, Polar52, Polar80, Toucan42		

insert plates



1

Part No.	692063	Ref. No.	0307050 0307050000
description	insert plate L 740mm W 490mm thickness 20mm F80 KL		
For models:	Falcon80, Polar80		

rubber bumper



1

Part No.	691570	Ref. No.	0940205 094020500
description	rubber pad type H200		



1

Part No.	691571	Ref. No.	0940210
description	rubber pad type H300		



1

Part No.	691569	Ref. No.	0940203
description	rubber pad type JUMBO		

oil separator filters

with thread



1

Part No.	691534	Ref. No.	0939000 0939160
description	oil separator filter flow rate 4m³/h ø 35mm L 52mm thread 3/8"		
For models:	MiniJumbo		



1

Part No.	691954	Ref. No.	0939162
description	oil separator filter flow rate 8m³/h ø 35mm L 85mm thread 3/8"		
For models:	Jumbo30, JumboPlus, Lynx32		



1

Part No.	691536	Ref. No.	0939001 0939161
description	oil separator filter flow rate 8m³/h ø 40mm L 70mm thread 1/2"		
For models:	JumboPlus		

without thread



1

Part No.	691540	Ref. No.	0939010 0939170
description	oil separator filter flow rate 100m³/h ø 72mm L 248mm		
For models:	Falcon2-60, Falcon2-70, Falcon52, Falcon80, Marlin42XL, Marlin46, Marlin52, Marlin90, Polar2-40, Polar2-50, Polar52, Polar80		



1



Part No.	691541	Ref. No.	0939015 0939175
description	oil separator filter flow rate 160m ³ /h ø 72mm L 375mm		
For models:	Polar2-75, Polar2-85, Polar2-95		

1



Part No.	691537	Ref. No.	0939003 0939163
description	oil separator filter flow rate 16m ³ /h ø 52mm L 120mm		
For models:	Boxer35, Boxer62, Jumbo35, Jumbo42, Jumbo42XL, Jumbo50, Lynx42		

1



Part No.	691538	Ref. No.	0939005 0939165
description	oil separator filter flow rate 21m ³ /h ø 72mm L 128mm		
For models:	Boxer35, Boxer42, Boxer42XL, Boxer52, H100, Marlin42, Marlin42XL, Toucan42, Vortex		

1



Part No.	691539	Ref. No.	0939011 0939171
description	oil separator filter flow rate 63m ³ /h ø 72mm L 206mm		
For models:	Falcon2-60, Falcon52, Marlin42XL, Marlin46, Marlin52, Marlin90, Polar2-40, Polar2-50, Polar52		

air cushions

1



Part No.	572001	Ref. No.	0301310
description	air cushion L 310mm W 85mm		
For models:	H500		

1



Part No.	572002	Ref. No.	0301330
description	air cushion L 330mm W 85mm		

1



Part No.	572003	Ref. No.	0301370
description	air cushion L 370mm W 85mm		
For models:	Falcon52, H300-AA, H300-RVS, Polar52		

1



Part No.	572004	Ref. No.	0301390
description	air cushion L 390mm W 85mm		
For models:	Falcon2-60		



1

Part No.	572005	Ref. No.	0301410
description	air cushion L 410mm W 85mm		
For models:	Falcon80, Polar80		



1

Part No.	572008	Ref. No.	0301550
description	air cushion L 550mm W 85mm		



1

Part No.	572006	Ref. No.	0301440
description	air cushion L 440mm W 85mm		
For models:	Falcon52, Polar52		



1

Part No.	572009	Ref. No.	0301580
description	air cushion L 580mm W 85mm		
For models:	H600, Polar2-40, Polar2-50, Polar2-75		



1

Part No.	572007	Ref. No.	0301490
description	air cushion L 490mm W 85mm		
For models:	Falcon2-60, Falcon2-70, Falcon80, Polar80		



1

Part No.	572010	Ref. No.	0301620 0301640
description	air cushion L 620mm W 85mm		
For models:	Polar2-40, Polar2-50, Polar2-75		



1

Part No.	572011	Ref. No.	0301660
description	air cushion L 660mm W 85mm		
For models:	H400-AA, H400-RVS, H700		



1

Part No.	572015	Ref. No.	0301860
description	air cushion L 860mm W 85mm		
For models:	Polar2-85		



1

Part No.	572012	Ref. No.	0301740
description	air cushion L 740mm W 85mm		
For models:	Falcon80, Polar2-75, Polar2-85, Polar80		



1

Part No.	572013	Ref. No.	0301800
description	air cushion L 800mm W 85mm		
For models:	Polar2-95		



1

Part No.	572014	Ref. No.	0301850
description	air cushion L 850mm W 85mm		
For models:	H800		

membranes



1

Part No.	691582	Ref. No.	0931410
description	membrane ø 110mm H 34mm		
For models:	H300-1, H300-2, H300-A-1, H300-A-2, H300-AA, H300-RVS, Marlin46, Marlin52, Marlin90		



1

Part No.	691579	Ref. No.	0931226
description	membrane ø 48mm H 5mm		
For models:	H300-1, H300-2, H300-A-1, H300-A-2, H300-AA, H300-RVS, Marlin52		



1

Part No.	691580	Ref. No.	0931400
description	membrane ø 50mm H 19mm		
For models:	Boxer35, H300-1, H300-2, H300-A-1, H300-A-2, H300-AA, H300-RVS, Jumbo35, Marlin52		



1

Part No.	691581	Ref. No.	0931405
description	membrane ø 80mm H 24mm		
For models:	Boxer42, Boxer42XL, Boxer42XL-BA, H200, H200-2, H200-A, H200-A-2, H200-XL, H200-XL-2, H220, H220-2, H220-A, H220-A-2, Jumbo42, Lynx32, Lynx42, Marlin42, Marlin42XL, Polar2-75, Polar2-85, Polar2-95		



1

Part No.	691578	Ref. No.	0931206
description	membrane ø 90mm H 1mm		
For models:	H800, Polar2-75, Polar2-85, Polar2-95		



oils



1

Part No.	890296	Ref. No.	0439510
description	oil type V32 1l for vacuum packing machine		
For models:	Lynx32, Lynx42		



1

Part No.	890248	Ref. No.	0439501
description	oil type VM22 1l for vacuum packing machine		



1

Part No.	890253	Ref. No.	0439520
description	oil type VM100 1l for vacuum packing machine		



1

Part No.	890200	Ref. No.	0439502
description	oil type VM32 0.25l for vacuum packing machine		
For models:	JumboPlus, Lynx32		



1

Part No.	890247	Ref. No.	0439500
description	oil type VM22 0.05l for vacuum packing machine		
For models:	MiniJumbo		



1

Part No.	890250	Ref. No.	0439503
description	oil type VM32 0.3l for vacuum packing machine		
For models:	Lynx42		



Part No.	890251	Ref. No.	0439505
description	oil type VM32 0.5l for vacuum packing machine		



Part No.	890252	Ref. No.	0439510 old version
description	oil type VM32 1l for vacuum packing machine		

oil filter



Part No.	691543	Ref. No.	0939091
description	oil filter size 160-300		
For models:	H800, Polar2-75, Polar2-85, Polar2-95		



Part No.	691542	Ref. No.	0939090
description	oil filter size 63-100 ø 78mm L 78mm		
For models:	Falcon2-60, Falcon2-70, Falcon52, Falcon80, Marlin42XL, Marlin46, Marlin52, Marlin90, Polar2-40, Polar52, Polar80		

PTFE tapes



Part No.	691526	Ref. No.	0305505
description	PTFE tape W 15mm thickness 0.25mm Qty supplied by meter		
For models:	Boxer35, Boxer42, Boxer42XL, Boxer42XL-BA, Falcon2-60, Falcon2-70, Falcon52, Falcon80, Jumbo35, Jumbo42, Marlin42, Marlin42XL, Marlin46, Marlin52, Marlin90, Polar2-40, Polar2-50, Polar2-75, Polar2-85, Polar2-95, Polar52, Polar80		



Part No.	691953	Ref. No.	0305513
description	PTFE tape W 46mm		
For models:	Lynx32, Lynx42		



1

Part No.	693842	Ref. No.	0305015 0305510 0305515 030551500
description	PTFE tape W 46mm thickness 0.1mm Qty supplied by meter		
For models:	Boxer35, Boxer42, Boxer42XL, Falcon2-60, Falcon2-70, Falcon52, Falcon80, H100, H150, H200, H200-2, H200-A, H200-A-2, H200-XL, H200-XL-2, H220, H220-2, H220-A, H220-A-2, H300-1, H300-2, H300-A-1, H300-A-2, H300-AA, H300-RVS, H400-AA, H400-RVS, H500, H600, H700, H800, Jumbo35, Jumbo42, JumboPlus, Lynx32, Lynx42, Marlin42, Marlin42XL, Marlin46, Marlin52, Marlin90, MiniJumbo, Polar2-40, Polar2-50, Polar2-75, Polar2-85, Polar2-95, Polar52, Polar80		



1

Part No.	691831	Ref. No.	0300020 0300020000
description	sealing bar L 277mm W 15mm H 31mm double weld		



1

Part No.	691997	Ref. No.	0300041 0300041000
description	sealing bar L 280mm W 16mm H 34mm double		
For models:	JumboPlus, MiniJumbo		

sealing bars



1

Part No.	691587	Ref. No.	0380590
description	bracket for sealing bar L 365mm W 25mm H 50mm aluminium		
For models:	Falcon2-60, H500		



1

Part No.	692207	Ref. No.	0300110
description	sealing bar L 323mm W 16mm H 34mm double		
For models:	H100, Marlin90		



1

Part No.	691632	Ref. No.	0300010 0300011
description	sealing bar L 277mm W 15mm H 31mm		
For models:	JumboPlus, MiniJumbo		



1

Part No.	692469	Ref. No.	0300116 0300116(DS)
description	sealing bar L 355mm W 15mm H 31mm double welding		
For models:	Boxer35, Jumbo30, Jumbo35		



1

Part No.	692103	Ref. No.	0300210
description	sealing bar L 420mm W 16mm H 34mm double		
For models:	Boxer42, Boxer42XL, Jumbo42, Jumbo42XL, Marlin42, Marlin42XL, Toucan42		



			
1			
Part No.	691998	Ref. No.	0300215 0300215000
description	sealing bar L 425mm W 16mm H 34mm cut-off seal		
For models:	Boxer42, Boxer42XL, Jumbo42, Jumbo42XL, Marlin42, Marlin42XL, Marlin52		

			
1			
Part No.	697922	Ref. No.	0300405
description	sealing bar L 466mm W 15mm H 30mm		
For models:	Falcon2-60		

			
1			
Part No.	691816	Ref. No.	0300337 0300337000
description	sealing bar L 500mm W 16mm H 34mm double		
For models:	Falcon80, Polar80		

			
1			
Part No.	692468	Ref. No.	0300320
description	sealing bar L 520mm W 15.5mm H 31mm		
For models:	Marlin52		

			
1			
Part No.	691999	Ref. No.	0300332 0300332000
description	sealing bar L 525mm W 16mm H 35mm double		
For models:	Falcon52, Polar52		

			
1			
Part No.	691801	Ref. No.	0300510
description	sealing bar L 565mm W 15mm H 33mm double weld		
For models:	Falcon2-60, Falcon2-70, Falcon80, Polar80		

			
1			
Part No.	692126	Ref. No.	0300310
description	sealing bar L 605mm W 15mm H 32mm		
For models:	Marlin52		

contacts for sealing bars

			
1			
Part No.	691559	Ref. No.	0900170
description	terminal for sealing bar mounting pos. left type DS		

			
1			
Part No.	691557	Ref. No.	0900152 0900160
description	terminal for sealing bar mounting pos. left type TS		
For models:	Lynx32, Lynx42		



 <p>1</p>			
Part No.	691556	Ref. No.	0330025 0900150 0900151
description	terminal for sealing bar mounting pos. left/right type table DS		
For models:	Boxer35, Boxer42, Boxer42XL, Falcon2-60, Falcon2-70, Falcon52, Falcon80, Jumbo35, Jumbo42, Lynx32, Lynx42, Marlin42, Marlin42XL, Marlin46, Marlin52, Marlin90, Polar2-40, Polar2-50, Polar2-75, Polar2-85, Polar2-95, Polar52, Polar80		

 <p>1</p>			
Part No.	691560	Ref. No.	0900172
description	terminal for sealing bar mounting pos. right type DS		

 <p>1</p>			
Part No.	691558	Ref. No.	0900154 0900161
description	terminal for sealing bar mounting pos. right type TS		
For models:	Lynx32, Lynx42		

miscellaneous

 <p>1</p>			
Part No.	696531	Ref. No.	0330093
description	end cap for sealing bar L 32mm W 25mm H 50mm		
For models:	Polar2-85		

heating wires

 <p>1</p>			
Part No.	572016	Ref. No.	0305003
description	heating wire W 3.5mm L 3000mm Qty 1		
For models:	Lynx32, Lynx42		

 <p>1</p>			
Part No.	572050	Ref. No.	0305000
description	heating wire W 3.5mm thickness 0.3mm Qty supplied by meter		
For models:	Boxer35, Boxer42, Boxer42XL, Boxer42XL-BA, Falcon2-60, Falcon2-70, Falcon52, Falcon80, H100, H150, H200, H200-2, H200-A, H200-A-2, H200-XL, H200-XL-2, H220, H220-2, H220-A, H220-A-2, H300-1, H300-2, H300-A-1, H300-A-2, H300-AA, H300-RVS, H400-AA, H400-RVS, H500, H600, H700, H800, Jumbo35, Jumbo42, JumboPlus, Lynx32, Lynx42, Marlin42, Marlin42XL, Marlin46, Marlin52, Marlin90, Mini-Jumbo, Polar2-40, Polar2-50, Polar2-75, Polar2-85, Polar2-95, Polar52, Polar80		

 <p>1</p>			
Part No.	572052	Ref. No.	0305019 0305020
description	heating wire W 5mm L 3000mm thickness 0.2mm Qty 1		
For models:	Boxer42XL-BA, Lynx32, Lynx42		



1

Part No.	572053	Ref. No.	0305025 0305028
description	heating wire W 8mm L 3000mm thickness 0.2mm Qty 1		
For models:	Lynx32, Lynx42		

service kits



1

Part No.	890254	Ref. No.	0940100 094010000
description	service kit container capacity 0.05l for vacuum packing machine type MJ		



1

Part No.	890255	Ref. No.	0940110
description	service kit container capacity 0.2l for vacuum packing machine type JP		
For models:	Lynx32		



1

Part No.	890262	Ref. No.	0940120 0940120000
description	service kit for vacuum packing machine type B35 / B-M 42/42XL		



1

Part No.	890261	Ref. No.	0940125 0940125000
description	service kit for vacuum packing machine type B42 XL BA/Toucan BA		



1

Part No.	890263	Ref. No.	0940140 0940140000
description	service kit for vacuum packing machine type F80/P80 LL		



1

Part No.	890256	Ref. No.	0940115
description	service kit for vacuum packing machine type J35/J42/B35		
For models:	Lynx42		



1

Part No.	890264	Ref. No.	0940130 0940130000
description	service kit for vacuum packing machine type M46-M/F/P 52		

1

Part No.	890265	Ref. No.	0940160 0940160000
description	service kit for vacuum packing machine type P2-40/50/75		

cut off wires

1

Part No.	572018	Ref. No.	0305009
description	cut off wire ø 1.1mm Qty 3m		
For models:	Lynx32, Lynx42		

1

Part No.	572051	Ref. No.	0305010
description	cut off wire ø 1.1mm Qty supplied by meter		
For models:	Boxer35, Boxer42, Boxer42XL, Falcon2-60, Falcon2-70, Falcon52, Falcon80, Lynx32, Lynx42, Marlin42, Marlin42XL, Marlin46, Marlin52, Marlin90, Polar2-40, Polar2-50, Polar2-75, Polar2-85, Polar2-95, Polar52, Polar80		

vacuum valves

1

Part No.	691550	Ref. No.	0281000
description	vacuum valve connection 1"		
For models:	Falcon2-60, Falcon2-70, Falcon52, Falcon80, H300-1, H300-2, H300-A-1, H300-A-2, H300-AA, H300-RVS, H500, H600, H700, Marlin46, Marlin52, Marlin90, Polar2-40, Polar2-50, Polar52, Polar80		

1

Part No.	691554	Ref. No.	0900850
description	vacuum valve connection 1 1/4"		

1

Part No.	691552	Ref. No.	0281020
description	vacuum valve connection 2"		
For models:	H800, Polar2-75, Polar2-85, Polar2-95		

locking screws

1

Part No.	691568	Ref. No.	0939115
description	locking screw thread 1" plastic		
For models:	Polar2-75, Polar2-85, Polar2-95		

1

Part No.	691566	Ref. No.	0939110
description	locking screw thread 1/2" plastic		
For models:	Boxer35, Boxer62, Falcon2-60, Falcon2-70, Falcon52, Falcon80, H300-1, H300-2, H300-A-1, H300-A-2, H300-AA, H300-RVS, H400-AA, H400-RVS, H500, H600, H700, H800, Jumbo35, Jumbo42, Jumbo50, Lynx32, Lynx42, Marlin42XL, Marlin46, Marlin52, Marlin90, Polar2-40, Polar2-50, Polar2-75, Polar2-85, Polar2-95, Polar52, Polar80		



1



Part No.	691565	Ref. No.	0939105
description	locking screw thread 1/4" SS		
For models:	JumboPlus, Lynx42		

1



Part No.	691564	Ref. No.	0939102
description	locking screw thread 1/8" SS		
For models:	MiniJumbo		

1



Part No.	691567	Ref. No.	0939113
description	locking screw thread 3/4" plastic		
For models:	Boxer35, Boxer42, Boxer42XL, Boxer62, Falcon2-60, Falcon2-70, Falcon52, Falcon80, H100, H300-1, H300-2, H300-A-1, H300-A-2, H300-AA, H300-RVS, H400-AA, H400-RVS, H500, H600, H700, H800, Jumbo35, Jumbo42, Jumbo50, Lynx42, Marlin42, Marlin42XL, Marlin46, Marlin52, Marlin90, Polar2-40, Polar52, Polar80		

maintenance sets

1



Part No.	691577	Ref. No.	0931225
description	maintenance set for air valve size 1"		
For models:	H300-1, H300-2, H300-A-1, H300-A-2, H300-AA, H300-RVS, Marlin52		

1



Part No.	691575	Ref. No.	0900872
description	maintenance set for air valve size 1 1/4"		

1



Part No.	691573	Ref. No.	0931205
description	maintenance set for air valve size 2"		
For models:	H800, Polar2-75, Polar2-85, Polar2-95		

1



Part No.	691576	Ref. No.	0931220
description	maintenance set for vacuum valve size 1"		
For models:	H300-1, H300-2, H300-A-1, H300-A-2, H300-AA, H300-RVS, Marlin52		

1



Part No.	691574	Ref. No.	0900870
description	maintenance set for vacuum valve size 1 1/4"		

1



Part No.	691572	Ref. No.	0931200
description	maintenance set for vacuum valve size 2"		
For models:	Polar2-75, Polar2-85, Polar2-95		



miscellaneous



1

Part No.	699619	Ref. No.	0070020
description	ball ED \varnothing 35.5mm		
For models:	DT100, DT60		



1

Part No.	692104	Ref. No.	0065225
description	connection head		
For models:	Falcon52, H300-1, H300-2, H300-A-1, H300-A-2, JumboPlus, Marlin46, Marlin52, Marlin90, MiniJumbo		



1

Part No.	692473	Ref. No.	0400730
description	flange ID \varnothing 37mm L 60mm W 60mm H 14mm for pipe		
For models:	Falcon2-60, Falcon2-70, Polar2-40, Polar2-50		



1

Part No.	691955	Ref. No.	0400732 0400735 0400735000
description	flange ID \varnothing 54mm L 80mm W 40mm H 14mm		
For models:	Polar2-75, Polar2-85, Polar2-95		



1

Part No.	692470	Ref. No.	0380710
description	guide bar L 425mm W 25mm H 25mm for vacuum packing machine		
For models:	Boxer42, Boxer42XL, H200, H200-2, H200-A, H200-A-2, H200-XL, H200-XL-2, H220, H220-2, H220-A, H220-A-2, Jumbo42XL, Marlin42, Marlin42XL, Toucan42		



1

Part No.	697923	Ref. No.	0401020
description	intake body ID \varnothing 5mm ED \varnothing 27mm L 24mm for vacuum packing machine		
For models:	Boxer35, Boxer42, Boxer42XL, Boxer52, Boxer62, H100, H150, H200, H200-2, H200-A, H200-A-2, H200-XL, H200-XL-2, H220, H220-2, H220-A, H220-A-2, Jumbo30, Jumbo35, Jumbo42, Jumbo42XL, Jumbo50, JumboPlus, Marlin42, Marlin42XL, MiniJumbo		

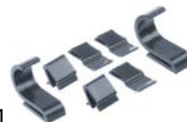

1

Part No.	697921	Ref. No.	0330115 0330116
description	mounting clip set plastic for front panel		
For models:	Boxer35, Boxer42, Boxer42XL, Boxer52, Boxer62, Falcon2-60, Falcon2-70, Falcon52, Falcon80, Jumbo30, Jumbo35, Jumbo42, Jumbo42XL, Jumbo50, JumboPlus, Lynx32, Lynx42, Marlin42, Marlin42XL, Marlin46, Marlin52, Marlin90, MiniJumbo, Polar2-40, Polar2-50, Polar2-75, Polar2-85, Polar2-95, Polar52, Polar80, Toucan42		



1

Part No.	699263	Ref. No.	0810110
description	non-return valve ID \varnothing 5mm ED \varnothing 7mm L 39.5mm W 19.2mm		
For models:	Falcon2-60, Falcon2-70, Falcon52, Falcon80, Marlin42XL, Marlin46, Marlin52, Marlin90, MiniJumbo, Polar2-40, Polar52, Polar80		

			
1			
Part No.	692471	Ref. No.	0810112
description	non-return valve ID ø 8mm ED ø 10mm L 39.5mm for vacuum packing machine		
For models:	JumboPlus, Lynx32		

			
1			
Part No.	697925	Ref. No.	0065221
description	screw ED ø 10mm W 22mm thread M4		
For models:	Boxer35, Boxer42, Boxer42XL, Falcon2-60, Falcon80, H100, H150, H200, H200-2, H200-A, H200-A-2, H200-XL, H200-XL-2, H220, H220-2, H220-A, H220-A-2, Jumbo35, Jumbo42, Marlin42XL, Polar52, Toucan42		

			
1			
Part No.	696530	Ref. No.	0390614
description	nozzle ID ø 5mm ED ø 8mm L 28mm H 50mm for vacuum packing machine thread M8x0.75		
For models:	Falcon2-60, Falcon2-70, Falcon52, Falcon80, Polar2-40, Polar2-50, Polar2-75, Polar2-85, Polar2-95, Polar52, Polar80		

			
1			
Part No.	691583	Ref. No.	0931230
description	sound damper ID ø 51.5mm ED ø 57mm H 32mm		
For models:	H800, Polar2-75, Polar2-85, Polar2-95		

			
1			
Part No.	690977	Ref. No.	0380702
description	rail for gasket L 280mm aluminium		
For models:	JumboPlus, MiniJumbo		

			
1			
Part No.	692066	Ref. No.	0390500 0390500000
description	spindle ED ø 6mm L 127mm		
For models:	JumboPlus, MiniJumbo		

			
1			
Part No.	697924	Ref. No.	0940207
description	repair kit ED ø 18mm L 33mm Food preparation equipment		

gaskets

O-rings

EPDM

			
1			
Part No.	692065	Ref. No.	0065250 0065250000
description	retaining ring for vacuum packing machine shaft ø 6mm thickness 0.7mm SS DIN 471		
For models:	Boxer35, Boxer42, Boxer42XL, Boxer52, Boxer62, H100, H150, H200, H200-2, H200-A, H200-A-2, H200-XL, H200-XL-2, H220, H220-2, H220-A, H220-A-2, Jumbo30, Jumbo35, Jumbo42, Jumbo42XL, Jumbo50, JumboPlus, Marlin42, Marlin42XL, MiniJumbo, Toucan42		

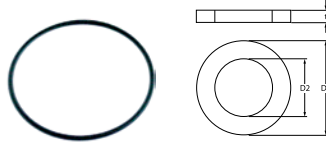
			
1			
Part No.	345896	Ref. No.	0065736 0065788
description	O-ring EPDM thickness 1.5mm ID ø 37mm Qty 1 pcs		
For models:	Falcon2-60, Falcon2-70, Polar2-40, Polar2-50		

			
1			
Part No.	517004	Ref. No.	0065730
description	O-ring EPDM thickness 2.62mm ID ø 34.6mm Qty 1 pcs		
For models:	Falcon2-60, Falcon2-70, Polar2-40, Polar2-50, Toucan42		

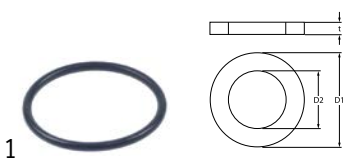
1

Part No.	532672	Ref. No.	0065741
description	O-ring EPDM thickness 2mm ID ø 25mm Qty 1 pcs		
For models:	Falcon2-60, Falcon2-70, Falcon52, Falcon80, Polar2-40, Polar2-50, Polar2-75, Polar2-85, Polar2-95, Polar52, Polar80		

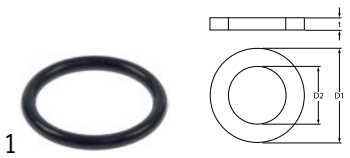

1

Part No.	527561	Ref. No.	0065740
description	O-ring EPDM thickness 3mm ID ø 22mm Qty 1 pcs		
For models:	Boxer35, Boxer42, Boxer42XL, Boxer42XL-BA, Boxer52, Boxer62, H100, Jumbo30, Jumbo35, Jumbo42, Jumbo42XL, Jumbo50, JumboPlus, Marlin42, Marlin42XL, MiniJumbo		

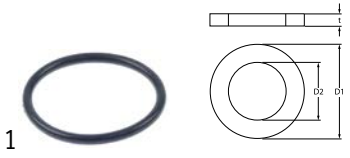

1

Part No.	532671	Ref. No.	0065732
description	O-ring EPDM thickness 3mm ID ø 34mm Qty 1 pcs		
For models:	Boxer62, Jumbo42XL, Jumbo50, Lynx32, Lynx42, Marlin46, Marlin52		

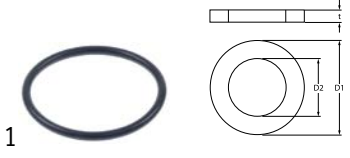

1

Part No.	532670	Ref. No.	0065729 0287000
description	O-ring EPDM thickness 3mm ID ø 40mm Qty 1 pcs		
For models:	Boxer35, Boxer42, Boxer42XL, Boxer52, Boxer62, H100, H150, H200, H200-2, H200-A, H200-A-2, H200-XL, H200-XL-2, H220, H220-2, H220-A, H220-A-2, H300-1, H300-2, Jumbo35, Jumbo42, Jumbo42XL, Jumbo50, JumboPlus, Lynx32, Lynx42, Marlin42, Marlin42XL, Marlin46, Marlin52, Marlin90		

NBR

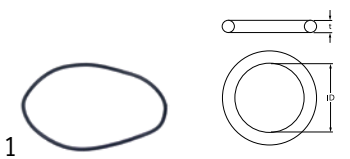

1

Part No.	532692	Ref. No.	0065734 0065786
description	O-ring NBR thickness 1.5mm ID ø 52mm		
For models:	Polar2-75, Polar2-85, Polar2-95		

sealing washers

rubber gaskets



1

Part No.	696391	Ref. No.	0065600
description	rubber gasket rubber ED ø 25mm ID ø 5.5mm thickness 2.5mm Qty 1 pcs		
For models:	Boxer35, Boxer42XL, H100, H150, H200, H200-2, H200-A, H200-A-2, H200-XL, H200-XL-2, H220, H220-2, H220-A, H220-A-2, Jumbo35, Jumbo42, JumboPlus, Marlin42XL, MiniJumbo, Toucan42		

foam rubber gaskets



1

Part No.	696390	Ref. No.	0320110
description	foam rubber gasket ø 3mm Qty supplied by meter		
For models:	Boxer35, Boxer42, Boxer42XL, Falcon2-60, Falcon2-70, Falcon52, Falcon80, Jumbo35, Jumbo42, JumboPlus, Lynx32, Lynx42, Marlin42, Marlin42XL, Marlin46, Marlin52, Marlin90, MiniJumbo, Polar2-40, Polar2-50, Polar2-75, Polar2-85, Polar2-95, Polar52, Polar80		



1

Part No.	693787	Ref. No.	0320100 0320100001
description	foam rubber gasket ø 6mm Qty supplied by meter		
For models:	JumboPlus, MiniJumbo, Vortex		

shaft gaskets

v-rings



1

Part No.	696559	Ref. No.	0065063
description	V-ring for shaft ø 32mm ID ø 31mm ED ø 39mm thickness 7mm		
For models:	Falcon2-60, Falcon2-70, Polar2-40, Polar2-50		



1

Part No.	692067	Ref. No.	0065068 0065068000
description	V-ring ID ø 45mm ED ø 55mm thickness 9mm		
For models:	Polar2-75, Polar2-85, Polar2-95		



special gaskets

for vacuum packers



Part No.	693787	Ref. No.	0320100 0320100001
description	foam rubber gasket ø 6mm Qty supplied by meter		
For models:	JumboPlus, MiniJumbo, Vortex		

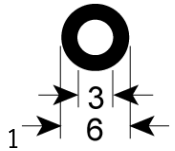

Part No.	570200	Ref. No.	0320220
description	gasket ø 6mm ID ø 3mm silicone for vacuum packing machine		
For models:	H100, H150, H200, H200-2, H200-A, H200-A-2, H200-XL, H200-XL-2, H220, H220-2, H220-A, H220-A-2, Toucan42		

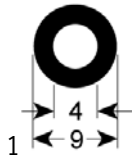

Part No.	570201	Ref. No.	0320227 0320228
description	gasket ø 9mm ID ø 4mm silicone Qty supplied by meter for vacuum packing machine		
For models:	H600, H800, Polar2-40, Polar2-50, Polar2-75, Polar2-85, Polar2-95		

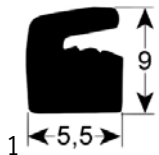

Part No.	570002	Ref. No.	0320216
description	lid gasket W 5.5mm H 9mm silicone Qty 10m		
For models:	Lynx32, Lynx42		

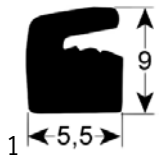

Part No.	900958	Ref. No.	0320217
description	lid gasket W 5.5mm H 9mm silicone Qty 20m for vacuum packing machine		
For models:	Lynx32, Lynx42		

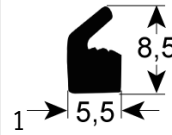

Part No.	900809	Ref. No.	0320215 0320217000 0320219
description	lid gasket W 5.5mm H 9mm silicone Qty supplied by meter for vacuum packing machine		
For models:	Boxer35, Boxer42, Boxer42XL, Boxer42XLBA, Boxer42XL-BA, Boxer52, Boxer62, H100, Jumbo35, Jumbo42, Jumbo42XL, Jumbo50, Jumbo-Plus, Lynx32, Lynx42, Marlin42, Marlin42XL, MiniJumbo, Toucan42		

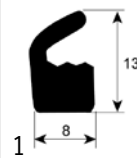

Part No.	570003	Ref. No.	0320208
description	lid gasket W 8mm H 13mm silicone Qty 12m		

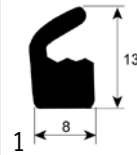

Part No.	900964	Ref. No.	0320209
description	lid gasket W 8mm H 13mm silicone Qty 20m for vacuum packing machine		

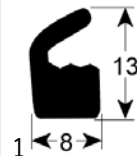

Part No.	900807	Ref. No.	0320210
description	lid gasket W 8mm H 13mm silicone Qty supplied by meter for vacuum packing machine		
For models:	Falcon2-60, Falcon2-70, Falcon52, Falcon80, H300-1, H300-2, H300-A-1, H300-A-2, H300-AA, H300-RVS, H400-AA, H400-RVS, H500, H600, H700, H800, Marlin46, Marlin52, Marlin90, Polar2-40, Polar2-50, Polar2-75, Polar2-85, Polar2-95, Polar52, Polar80		

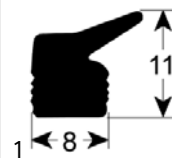

Part No.	900965	Ref. No.	0320214
description	lid gasket W 8mm H 11mm silicone Qty 20m for vacuum packing machine		



Part No.	900808	Ref. No.	0320212
description	lid gasket W 8mm H 11mm silicone supplied by meter for vacuum packing machine		
For models:	Polar2-40, Polar2-50, Polar2-75, Polar2-85		

Part No.	900806	Ref. No.	0220200 0320200 0320201 0320202
description	gasket W 16mm H 7.5mm silicone Qty supplied by meter for vacuum packing machine		
For models:	Boxer35, Boxer42, Boxer42XL, Boxer62, Falcon2-60, Falcon2-70, Falcon52, Falcon80, H100, H150, H200, H200-2, H200-A, H200-A-2, H200-XL, H200-XL-2, H220, H220-2, H220-A, H220-A-2, H300-1, H300-2, H300-A-1, H300-A-2, H300-AA, H300-RVS, H400-AA, H400-RVS, H500, H600, H700, H800, Jumbo30, Jumbo35, Jumbo42, Jumbo42XL, Jumbo50, JumboPlus, Lynx32, Lynx42, Marlin42, Marlin42XL, Marlin46, Marlin52, Marlin90, MiniJumbo, Polar2-40, Polar2-50, Polar2-75, Polar2-85...(Other models you can see in the webshop)		

springs

torsion springs

Part No.	691532	Ref. No.	0080035
description	compression spring \varnothing 46mm L2 87mm wire gauge \varnothing 10mm L1 340mm L3 87mm		
For models:	Falcon80		

Part No.	691533	Ref. No.	0080036
description	compression spring \varnothing 46mm L2 87mm wire gauge \varnothing 10mm L1 340mm L3 87mm		
For models:	Falcon80		

compression springs

Part No.	697920	Ref. No.	0080005
description	compression spring \varnothing 11.2mm L 16mm wire gauge \varnothing 1.5mm windings 3		
For models:	H600, H800, Polar2-40, Polar2-50, Polar2-75, Polar2-85, Polar2-95		

Part No.	691531	Ref. No.	0080020
description	compression spring \varnothing 15.2mm L 52mm wire gauge \varnothing 2mm for vacuum packing machine		
For models:	Falcon2-60, Falcon2-70, Falcon52, H300-AA, H300-RVS, H500, H600, H700, H800, Polar2-40, Polar2-50, Polar2-75, Polar2-85, Polar2-95, Polar52		

Part No.	691530	Ref. No.	0080030
description	compression spring \varnothing 32.7mm L 240mm wire gauge \varnothing 5.2mm for vacuum packing machine		
For models:	H400-AA		

gas tension springs

gas tension springs

Part No.	698531	Ref. No.	0810201
description	gas tension spring 385N hub 40mm D1 \varnothing 8mm D2 \varnothing 18mm hole distance 145mm hole \varnothing 6.4mm L 155mm		

Part No.	701302	Ref. No.	0955003
description	gas tension spring 450N hub 90mm D1 \varnothing 6mm D2 \varnothing 15mm hole distance 230mm hole \varnothing 6mm L 240mm		

Part No.	691528	Ref. No.	0810200
description	gas tension spring for vacuum packing machine 370N hub 40mm D1 \varnothing 18mm D2 \varnothing 8mm hole distance 145mm hole \varnothing 6.2mm L 155mm		
For models:	Boxer35, Boxer42, H100, H150, H200, H200-2, H200-A, H200-A-2, H220, H220-2, H220-A, H220-A-2, Jumbo30, Jumbo35, Jumbo42, JumboPlus, Marlin42, MiniJumbo		

Part No.	691529	Ref. No.	0810205 0810215
description	gas tension spring for vacuum packing machine 500N hub 65mm D1 \varnothing 18mm D2 \varnothing 8mm hole distance 225mm hole \varnothing 6.3mm L 235mm		
For models:	Boxer42, Boxer42XL, H200-XL, H200-XL-2, Jumbo50, Marlin42XL, Marlin46, Marlin52, Marlin90		

tension springs

Part No.	504449	Ref. No.	0080107
description	tension spring \varnothing 70mm total length 340mm wire gauge \varnothing 8mm for vacuum packing machine Qty 1 pcs		
For models:	Polar2-85		



manometers

			
1			
Part No.	541528	Ref. No.	0810101
description	manometer ø 40mm pressure range 0 up to 1bar connection angled connection ø 5mm		
For models:	Boxer35, Boxer42, Boxer42XL, Boxer52, Boxer62, Falcon52, H100, H150, H200, H200-2, H200-A, H200-A-2, H200-XL, H200-XL-2, H220, H220-2, H220-A, H220-A-2, H300-1, H300-2, H300-A-1, H300-A-2, H300-AA, H300-RVS, H400-AA, H400-RVS, H500, H600, H700, H800, Jumbo30, Jumbo35, Jumbo42, Jumbo42XL, Jumbo50, JumboPlus, Marlin42, Marlin42XL, Marlin46, Marlin52, Marlin90, MiniJumbo, Polar2-40, Polar2-50, Polar2-75, Polar2-85, Polar2-95, Polar52, Polar80, Toucan42		

hoses

industrial hoses

extraction and pressure hoses

			
1			
Part No.	570202 ¹	Ref. No.	0322052
description	pressure hose ID ø 7mm ED ø 13mm Lm operating p. 10bar burst p. 30bar temp.-resist. -30 up to +80°C		
For models:	Boxer35, Boxer42, Boxer42XL, Boxer52, Falcon2-60, Falcon2-70, Falcon52, Falcon80, H100, H150, H200, H200-2, H200-A, H200-A-2, H200-XL, H200-XL-2, H220, H220-2, H220-A, H220-A-2, H300-1, H300-2, H300-A-1, H300-A-2, H300-AA, H300-RVS, H400-AA, H400-RVS, H500, H600, H700, H800, Lynx32, Lynx42, Marlin42, Marlin42XL, Marlin46, Marlin52, Marlin90, MiniJumbo, Polar2-40, Polar2-50, Polar2-75, Polar2-85, Polar2-95, Polar52, Polar80, Toucan42		

¹by the meter

fittings, hose and pipe connectors

hose connectors

plastic

			
1			
Part No.	361696	Ref. No.	0260255
description	hose connector plastic straight thread 3/8" hose ø 8mm Qty 1 pcs		
For models:	Falcon2-60, Falcon2-70, Falcon52, Marlin52, Polar52		

			
1			
Part No.	361752	Ref. No.	0260005
description	hose connector plastic angled thread 1/8" hose ø 4mm Qty 1 pcs		
For models:	Boxer35, Boxer42, Boxer42XL, Boxer42XL-BA, Boxer52, Boxer62, Falcon2-60, Falcon2-70, Falcon52, Falcon80, H100, H150, H200, H200-2, H200-A, H200-A-2, H200-XL, H200-XL-2, H220, H220-2, H220-A, H220-A-2, H300-1, H300-2, H300-A-1, H300-A-2, H300-AA, H300-RVS, H400-AA, H400-RVS, H500, H600, H700, H800, Jumbo30, Jumbo35, Jumbo42, Jumbo42XL, Jumbo50, JumboPlus, Lynx32, Lynx42, Marlin42, Marlin42XL, Marlin46, Marlin52, Marlin90, MiniJumbo, Polar2-40, Polar2-50...(Other models you can see in the webshop)		

measuring equipment

meters

pressure measurement

digital manometers

absolute-pressure measurement

			
1			
Part No.	800002	Ref. No.	0930300
description	pressure meter 0 up to 1300mbar type GMH 3161-12 vacuum + barometric pressure probe type absolute pressure sensor measurement unit mbar,bar,kPa,MPa,PSI,mmHg,mH2O connections 1 min/max value, tare, hold resolution 1mbar hose ø 4mm accuracy (temperature) ±0.4%FS accuracy (hysteresis) ±0.2%FS overload max. 4 bar interface serial (adapter not included) sensor piezoresistant gauge pressure sensor, int. dimensions 142x71x26mm incl. battery		

fastening material

screws

countersunk screws

			
1			
Part No.	560076	Ref. No.	0042115
description	countersunk screw thread M4 L 10mm SS DIN 963/ISO 2009 Qty 20 pcs intake slotted head ø 7.5mm		
For models:	Boxer35, Boxer42, Boxer42XL, DT100, DT60, H100, H150, H200, H200-2, H200-A, H200-A-2, H200-XL, H200-XL-2, H220, H220-2, H220-A, H220-A-2, H300-1, H300-2, H300-A-1, H300-A-2, Jumbo35, Marlin42, Marlin42XL, Marlin46, Marlin90, Toucan42		



 <p>1</p>			
Part No.	560263	Ref. No.	0042118
description	countersunk screw thread M4 L 25mm SS DIN 963/ISO 2009 Qty 20 pcs intake slotted head ø 7.5mm		
For models:	Boxer52, Boxer62, Falcon52, Jumbo42, JumboPlus, Marlin46, Marlin52, MiniJumbo, Vortex		

flat-headed bolts

 <p>1</p>			
Part No.	560061	Ref. No.	0041100
description	flat-headed bolt thread M4 thread L 6mm SS DIN 7985/ISO 7045 Qty 20 pcs intake Phillips head ø 8mm head thickness 2mm		
For models:	Boxer52, Falcon2-60, Falcon2-70, Falcon52, Falcon80, H300-AA, H300-RVS, H500, H700, Jumbo50, JumboPlus, Lynx32, Lynx42, Marlin46, Marlin52, MiniJumbo, Polar80, Vortex		

hexagonal screws

 <p>1</p>			
Part No.	560090	Ref. No.	0031259
description	hexagonal screw thread M6 thread L 30mm SS WS 10 Qty 20 pcs DIN 933 / ISO 4017		
For models:	DT100, DT60, Falcon2-60, Falcon2-70, H300-1, H300-2, H300-A-1, H300-A-2, H600, H800, Marlin46, Marlin52, Marlin90, Polar2-40, Polar2-50, Polar2-75, Polar2-85, Polar2-95, Vortex		

side bolts

 <p>1</p>			
Part No.	560298	Ref. No.	0065016
description	flat-headed bolt thread M6 L 20mm SS Qty 1 pcs intake hexagonal 4mm		
For models:	Boxer35, Boxer42, Boxer42XL, Boxer42XLBA, Boxer42XL-BA, Boxer52, Boxer62, Falcon2-60, Falcon2-70, H100, H150, H200, H200-2, H200-A, H200-A-2, H200-XL, H200-XL-2, H220, H220-2, H220-A, H220-A-2, Jumbo30, Jumbo35, Jumbo42, Jumbo42XL, Jumbo50, Marlin42, Marlin42XL		

knurled screws

 <p>1</p>			
Part No.	560421	Ref. No.	0065010
description	Thumb screw thread M4 thread L 10mm ø 16mm H 13mm SS		
For models:	H100, H150, H200, H200-2, H200-A, H200-A-2, H200-XL, H200-XL-2, H220, H220-2, H220-A, H220-A-2, JumboPlus, MiniJumbo, Vortex		

nuts

cap nuts

 <p>1</p>			
Part No.	560137	Ref. No.	0020096
description	cap nuts thread M6 WS 10 SS Qty 20 pcs DIN/ISO DIN 1587		
For models:	Falcon2-60, Falcon2-70, Polar2-40, Polar2-50, Polar2-75, Polar2-85, Polar2-95		

hexagonal nuts

DIN 934 / ISO 4032/8673

 <p>1</p>			
Part No.	511212	Ref. No.	0020030
description	hexagonal nut thread M6 H 5mm WS 10 SS DIN/ISO DIN 934 / ISO 4032/8673 Qty 1 pcs		
For models:	Boxer35, Boxer42, Boxer42XL, Boxer42XL-BA, Boxer52, Boxer62, DT100, DT60, Falcon2-60, Falcon2-70, Falcon52, Falcon80, H100, H150, H200, H200-2, H200-A, H200-A-2, H200-XL, H200-XL-2, H220, H220-2, H220-A, H220-A-2, H300-1, H300-2, H300-A-1, H300-A-2, H300-AA, H400-AA, Jumbo30, Jumbo35, Jumbo42, Jumbo42XL, Jumbo50, JumboPlus, Lynx32, Lynx42, Marlin42, Marlin42XL, Marlin46, Marlin52, Marlin90, MiniJumbo, Polar2-40, Polar2-50, Polar2-75, Polar2-85, Polar2-95, Polar52...(Other models you can see in the webshop)		

DIN 985

 <p>1</p>			
Part No.	560142	Ref. No.	0020035
description	hexagonal nut thread M6 H 6mm SS WS 10 Qty 20 pcs DIN/ISO DIN 985 self-locking		
For models:	Boxer35, Boxer42, Boxer42XL, DT100, DT60, Falcon2-60, Falcon2-70, Falcon52, H100, H150, H200, H200-2, H200-A, H200-A-2, H200-XL, H200-XL-2, H220, H220-2, H220-A, H220-A-2, H300-1, H300-2, H300-A-1, H300-A-2, H300-AA, H500, H700, Jumbo30, Jumbo35, Jumbo42, Jumbo42XL, Jumbo50, JumboPlus, Lynx32, Lynx42, Marlin42, Marlin42XL, Marlin46, Marlin90, MiniJumbo, Polar2-40, Polar2-50, Polar2-75, Polar2-85, Polar2-95, Polar52, Polar80, Vortex		

1 tools, fastening materials, consumables



washers

washers

DIN 125A



1

Part No.	560333	Ref. No.	0010026
description	plain washer ID ø 6.4mm ED ø 12mm thickness 1.6mm SS Qty 1 pcs DIN 125A for thread M6		
For models:	Boxer42, Boxer42XL, DT100, DT60, Falcon2-60, Falcon2-70, Falcon52, Falcon80, H220, H220-2, H220-A, H220-A-2, H300-1, H300-2, H300-A-1, H300-A-2, H300-AA, H300-RVS, H400-AA, H400-RVS, H500, H600, H700, H800, Lynx32, Lynx42, Marlin42XL, Marlin46, Marlin52, Marlin90, Polar2-40, Polar2-50, Polar2-75, Polar2-85, Polar2-95, Polar52, Polar80, Toucan42, Vortex		



2

Part No.	560113	Ref. No.	0010026
description	plain washer ID ø 6.4mm ED ø 12mm thickness 1.6mm SS Qty 20 pcs DIN 125A for thread M6		

fasteners

retaining rings

DIN 471



1

Part No.	692065	Ref. No.	0065250 0065250000
description	retaining ring for vacuum packing machine shaft ø 6mm thickness 0.7mm SS DIN 471		
For models:	Boxer35, Boxer42, Boxer42XL, Boxer52, Boxer62, H100, H150, H200, H200-2, H200-A, H200-A-2, H200-XL, H200-XL-2, H220, H220-2, H220-A, H220-A-2, Jumbo30, Jumbo35, Jumbo42, Jumbo42XL, Jumbo50, JumboPlus, Marlin42, Marlin42XL, MiniJumbo, Toucan42		



1

Part No.	523025	Ref. No.	0065260
description	retaining ring shaft ø 24mm thickness 1mm SS DIN 471		
For models:	H500, H600, H700, H800, Polar2-40, Polar2-50, Polar2-75, Polar2-85, Polar2-95		



1

Part No.	560302	Ref. No.	0065251
description	retaining ring shaft ø 8mm thickness 0.8mm SS DIN 471		
For models:	Boxer35, Boxer42, Boxer42XL, Boxer52, Boxer62, H100, H150, H200, H200-2, H200-A, H200-A-2, H200-XL, H200-XL-2, H220, H220-2, H220-A, H220-A-2, Jumbo30, Jumbo35, Jumbo42, Jumbo42XL, Jumbo50, Lynx32, Lynx42, Marlin42, Marlin42XL, Toucan42		

consumables

lubricants

oils

for vacuum pumps



1

Part No.	890296	Ref. No.	0439510
description	oil type V32 1l for vacuum packing machine		
For models:	Lynx32, Lynx42		



1

Part No.	890253	Ref. No.	0439520
description	oil type VM100 1l for vacuum packing machine		





1

Part No.	890247	Ref. No.	0439500
description	oil type VM22 0.05l for vacuum packing machine		
For models:	MiniJumbo		



			
1			
Part No.	890248	Ref. No.	0439501
description	oil type VM22 1l for vacuum packing machine		

			
1			
Part No.	890251	Ref. No.	0439505
description	oil type VM32 0.5l for vacuum packing machine		

			
1			
Part No.	890200	Ref. No.	0439502
description	oil type VM32 0.25l for vacuum packing machine		
For models:	JumboPlus, Lynx32		

			
1			
Part No.	890252	Ref. No.	0439510 old version
description	oil type VM32 1l for vacuum packing machine		

			
1			
Part No.	890250	Ref. No.	0439503
description	oil type VM32 0.3l for vacuum packing machine		
For models:	Lynx42		

GASTROPARTS.COM

