



**GASTROPARTS**

# Heidebrenner

- [EN]** Equipment
- [DE]** Geräte
- [ES]** Aparatos
- [FR]** Équipement
- [IT]** Attrezzature
- [PL]** Urządzenia
- [RU]** Оборудование

✉ [gastroparts@gastroparts.com](mailto:gastroparts@gastroparts.com)

☎ +48 56 657 00 66

📘 [fb.com/gastroparts.global](https://fb.com/gastroparts.global)



**GASTROPARTS.COM**







## heating elements

### heating elements for ovens

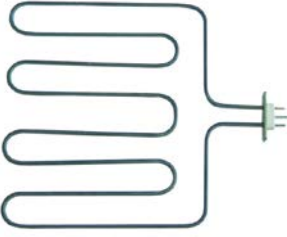
 <p>1</p>			
<b>Part No.</b>	415318	<b>Ref. No.</b>	92732
<b>description</b>	heating element 2000W 230V L 427mm W 138mm L1 50mm L2 377mm W1 54mm W2 30mm windings 2 connection plug-in connection heating circuits 1 tube ø 6.3mm rectangular flange dry heating element hole distance 56mm flange length 70mm flange width 23mm hole ø M4mm		
<b>accessories for</b>	415318		
	<b>Part No.</b>	550404	<b>Ref. No.</b> —
	power socket I-II phase 240V max. 16A countries I with screw connection for heating element		
	<b>Part No.</b>	550405	<b>Ref. No.</b> —
	power socket male faston 6.3mm for heating element 2-pole + earthing		

 <p>1</p>			
<b>Part No.</b>	415320	<b>Ref. No.</b>	92734
<b>description</b>	heating element 3000W 230V L 350mm W 313mm L1 75mm L2 275mm W1 138mm W2 31mm connection plug-in connection heating circuits 1 tube ø 6.3mm rectangular flange dry heating element hole distance 57mm flange length 70mm flange width 22mm hole ø M4mm connection length 34mm		
<b>accessories for</b>	415320		
	<b>Part No.</b>	550404	<b>Ref. No.</b> —
	power socket I-II phase 240V max. 16A countries I with screw connection for heating element		
	<b>Part No.</b>	550405	<b>Ref. No.</b> —
	power socket male faston 6.3mm for heating element 2-pole + earthing		

### radiation heaters

<h4>1-circuit</h4>  <p>1</p>			
<b>Part No.</b>	490150	<b>Ref. No.</b>	94706
<b>description</b>	radiation heater ø 250mm 2500W 230V heating circuits 1 energy regulation with temperature signalization with heating coil connections 2+2 connection type male faston 6.3mm EGO		

## hot plates

### round

with cast brim

with screw connection

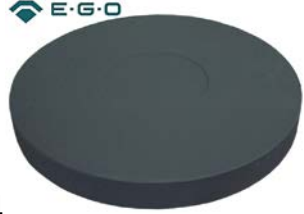
 <p>1</p>			
<b>Part No.</b>	490107	<b>Ref. No.</b>	94201
<b>description</b>	hot plate ø 400mm 5000W 400V connection 4x 2 screw clamps with cast edge screw bolt H 42mm		

## energy regulators

### EGO

#### 1-circuit

 <p>1</p>			
<b>Part No.</b>	380015	<b>Ref. No.</b>	94707
<b>description</b>	energy regulator 230V 13A single-circuit turn direction right shaft ø 6x4.6mm shaft L 23mm mounting thread M4 power release 6-100% no. 50.57021.010		

## thermostats

### control and safety thermostats

#### EGO

#### control thermostats

#### 55.10/19\_ series

 <p>1</p>			
<b>Part No.</b>	375313	<b>Ref. No.</b>	94229
<b>description</b>	thermostat t.max. 358°C temperature range 60-358°C 1-pole 1NO 16A probe ø 3.03mm probe L 178mm capillary pipe 870mm capillary pipe isolated 870mm gland nut shaft L 23mm shaft position upper rotation 270°		



## safety thermostats

55.10/19\_ series

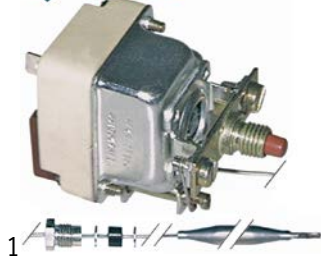

<b>Part No.</b>	390061	<b>Ref. No.</b>	94306
<b>description</b>	safety thermostat switch-off temp. 220°C 1-pole 0.5A probe ø 6mm probe L 140mm capillary pipe 900mm capillary pipe isolatedmm gland nut probe M9x1		

## accessories

## gland nut accessories

ducts



<b>Part No.</b>	550271	<b>Ref. No.</b>	26001
<b>description</b>	gland duct ET M12x0.75 IT M9x1 with gasket and nut		

## switches and momentary switches

## cam switches

5-position

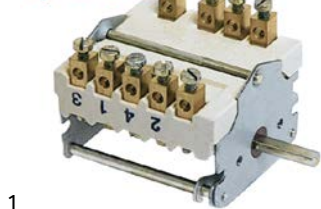

<b>Part No.</b>	300105	<b>Ref. No.</b>	94202
<b>description</b>	cam switch 5 operating positions 3NO/1CO sequence 0-1-2-3-4 32A shaft ø 6x4.6mm shaft L 23mm connection screw 5-position ceramic		

7-position



<b>Part No.</b>	300031	<b>Ref. No.</b>	94214
<b>description</b>	cam switch 7 operating positions 1NO/2CO sequence 0-1-2-3-4-5-6 16A shaft ø 6x4.6mm shaft L 23mm connection male faston 6.3mm 7-position plastic		

## operation switches



<b>Part No.</b>	300067	<b>Ref. No.</b>	94215
<b>description</b>	cam switch 3 operating positions 4NO 16A sequence 0-1-2 shaft ø 6x4.6mm shaft L 23mm connection male faston 6.3mm plastic		

## lamps

## indicator lights

## lamps

## neon light bulbs



<b>Part No.</b>	359602	<b>Ref. No.</b>	94232
<b>description</b>	neon light bulb socket E14 230V clear ø 14mm L 30mm		

## screw-on/push-on fit

## neon light bulbs



<b>Part No.</b>	359602	<b>Ref. No.</b>	94232
<b>description</b>	neon light bulb socket E14 230V clear ø 14mm L 30mm		

## electric accessories

## cables

## copper wire

up to 200°C



<b>Part No.</b>	550074	<b>Ref. No.</b>	94428
<b>description</b>	copper wire 1mm <sup>2</sup> permanent temperature -60 up to +200°C conductor nickel-plated copper wire insulation glass fibre braiding/silicone rubber Qty 10m brown t.max. 250°C rated 300/500V test voltage 2000V		



terminals and connectors

not insulated

female fastons

iron nickel-plated



1

<b>Part No.</b>	550001	<b>Ref. No.</b>	26009 93284
<b>description</b>	female faston size 6.3x0.8mm 1.0-2.5mm <sup>2</sup> straight Fe gal Ni t.max. 340°C Qty 100 pcs		

terminals

connection terminals with screw/faston connections



1

<b>Part No.</b>	550109	<b>Ref. No.</b>	94351
<b>description</b>	power terminal block 3-pole max. 40A max 250V connection M6/ male faston 6.3mm temp.-resist. 130°C		

gas taps





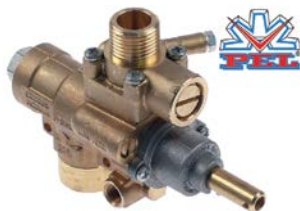



PEL

23S/V series



1

<b>Part No.</b>	101630	<b>Ref. No.</b>	94600
<b>description</b>	gas tap PEL type 23S/V gas inlet 1/2" IT bypass nozzle $\varnothing$ 0.35mm gas outlet 1/2" MT (tube $\varnothing$ 14mm) thermocouple connection M10x1 pilot connection M10x1 shaft $\varnothing$ 10mm shaft L 25mm shaft flat		
<b>spare parts for</b>	101630		
	<b>Part No.</b>	100455	<b>Ref. No.</b> —
	bypass nozzle type PEL23/24 bore $\varnothing$ 0.35mm thread M8x0.5		
	<b>Part No.</b>	101059	<b>Ref. No.</b> 94615
	magnet unit T1: M10x1 T2: M22x1 L 46mm $\varnothing$ 18mm suitable for PEL23S M10x1		
	<b>Part No.</b>	102767	<b>Ref. No.</b> —
	gas tap front part shaft $\varnothing$ 10mm shaft L 26.5mm shaft flat suitable for PEL23S		
<b>accessories for</b>	101630		
	<b>Part No.</b>	100908	<b>Ref. No.</b> —
	union screw thread M10x1 for pipe $\varnothing$ 4mm Qty 1 pcs		

<b>accessories for</b>	101630		
	<b>Part No.</b>	100909	<b>Ref. No.</b> —
	union screw thread M10x1 for pipe $\varnothing$ 6mm Qty 1 pcs		
	<b>Part No.</b>	100945	<b>Ref. No.</b> —
	roll pin $\varnothing$ 3.2mm L 10mm		
	<b>Part No.</b>	101218	<b>Ref. No.</b> —
	shaft extension JUNKERS		
	<b>Part No.</b>	101219	<b>Ref. No.</b> —
	shaft extension L 25mm JUNKERS		
	<b>Part No.</b>	101246	<b>Ref. No.</b> —
	olive for pipe $\varnothing$ 4mm Qty 1 pcs		
	<b>Part No.</b>	101286	<b>Ref. No.</b> —
	olive ID $\varnothing$ 6mm Qty 1 pcs		
	<b>Part No.</b>	110064	<b>Ref. No.</b> 93207
	knob		
	<b>Part No.</b>	110066	<b>Ref. No.</b> —
	knob screw		
	<b>Part No.</b>	550396	<b>Ref. No.</b> —
	shaft extension L 25mm JUNKERS		

alternatives to EGA

GPEL22 series

with nozzle outlet



1















<b>Part No.</b>	106676	<b>Ref. No.</b>	94444 Düse 2,0mm
<b>description</b>	gas tap alternatives to EGA type GPEL22D nozzle outlet gas inlet M18x1.5 (tube $\varnothing$ 12mm) external nozzle $\varnothing$ 2mm internal nozzle $\varnothing$ 1.3mm bypass nozzle $\varnothing$ 0.55mm mixing pipe connection M22x1 thermocouple connection M8x1 pilot connection closed shaft $\varnothing$ 9x6.5mm shaft L 26/15mm shaft flat upper and bottom		
<b>spare parts for</b>	106676		
	<b>Part No.</b>	100927	<b>Ref. No.</b> —
	torsion spring L 2.8-8.0mm for internal nozzle $\varnothing$ 3mm bore $\varnothing$ mm		
	<b>Part No.</b>	101058	<b>Ref. No.</b> 93122
	magnet unit L 39mm D1 $\varnothing$ 15.4mm D2 $\varnothing$ 13.5mm suitable for PEL22/ EGA24197 standard		
	<b>Part No.</b>	101230	<b>Ref. No.</b> —
	thermocouple nut T1: M8x1 T2: M18x1 aluminium		
	<b>Part No.</b>	101460	<b>Ref. No.</b> —
	O-ring $\varnothing$ 12.37mm D1 $\varnothing$ 2.62mm suitable for PEL22		

Table continues overleaf



<b>spare parts for</b> 106676				
	Part No.	101527	Ref. No.	—
	O-ring Viton thickness 1.78mm ID ø 6.75mm Qty 1 pcs			
	Part No.	101594	Ref. No.	—
	adjusting screw for internal nozzle thread M10x0.75			
<b>accessories for</b> 106676				
	Part No.	100944	Ref. No.	—
	union nut thread M18x1.5 for pipe ø 12mm			
	Part No.	101273	Ref. No.	93107
	olive for pipe ø 12mm L 9.5mm brass Qty 1 pcs suitable for universal			
	Part No.	112173	Ref. No.	N/A
	knob universal ø 62mm black without adaptor/dial plate			
	Part No.	112179	Ref. No.	N/A
	knob adapter shaft ø 9x6.5mm L 0mm			
	Part No.	112285	Ref. No.	—
	knob dial plate silver gas tap without ignition flame PEL20 t.max.°C ED ø 59mm ID ø 45.5mm			

				
1				
<b>Part No.</b>	106960	<b>Ref. No.</b>	94443	
<b>description</b>	gas tap alternatives to EGA type GPEL22D with nozzle outlet (with nozzle) gas inlet M18x1.5 (tube ø 12mm) external nozzle ø 3.1mm internal nozzle ø 1.8mm bypass nozzle ø 0.5mm mixing pipe connection M22x1 thermocouple connection M8x1 pilot connection M10x1 shaft ø 6.5x9mm shaft L 26/15mm shaft flat upper and bottom			
<b>spare parts for</b> 106960				
	Part No.	100390	Ref. No.	94452
	bypass nozzle type PEL22 bore ø 0.5mm thread M6x0.5			
	Part No.	100908	Ref. No.	—
	union screw thread M10x1 for pipe ø 4mm Qty 1 pcs			
	Part No.	100927	Ref. No.	—
	torsion spring L 2.8-8.0mm for internal nozzle ø 3mm bore ømm			
	Part No.	101058	Ref. No.	93122
	magnet unit L 39mm D1 ø 15.4mm D2 ø 13.5mm suitable for PEL22/ EGA24197 standard			
	Part No.	101230	Ref. No.	—
	thermocouple nut T1: M8x1 T2: M18x1 aluminium			
	Part No.	101246	Ref. No.	—
	olive for pipe ø 4mm Qty 1 pcs			
	Part No.	101460	Ref. No.	—
	O-ring ø 12.37mm D1 ø 2.62mm suitable for PEL22			
	Part No.	101527	Ref. No.	—
	O-ring Viton thickness 1.78mm ID ø 6.75mm Qty 1 pcs			















<b>spare parts for</b> 106960				
	Part No.	101594	Ref. No.	—
	adjusting screw for internal nozzle thread M10x0.75			
<b>accessories for</b> 106960				
	Part No.	100944	Ref. No.	—
	union nut thread M18x1.5 for pipe ø 12mm			
	Part No.	101273	Ref. No.	93107
	olive for pipe ø 12mm L 9.5mm brass Qty 1 pcs suitable for universal			
	Part No.	110217	Ref. No.	—
	knob gas tap with ignition flame ø 64mm shaft ø 9x7mm shaft flat horizontal black			

				
1				
<b>Part No.</b>	106040	<b>Ref. No.</b>	N/A	
<b>description</b>	gas tap alternatives to EGA type GPEL22D with nozzle outlet (without nozzle) gas inlet M18x1.5 (tube ø 12mm) external nozzle ømm internal nozzle ømm bypass nozzle ø 0.35mm mixing pipe connection M22x1 thermocouple connection M8x1 pilot connection closed shaft ø 9x6.5mm shaft L 34/15mm shaft flat upper and bottom			
<b>spare parts for</b> 106040				
	Part No.	100259	Ref. No.	—
	bypass nozzle type PEL22 bore ø 0.35mm thread M6x0.5			
	Part No.	101058	Ref. No.	93122
	magnet unit L 39mm D1 ø 15.4mm D2 ø 13.5mm suitable for PEL22/ EGA24197 standard			
	Part No.	101230	Ref. No.	—
	thermocouple nut T1: M8x1 T2: M18x1 aluminium			
	Part No.	101823	Ref. No.	—
	gas tap front part shaft ø 6x4.6mm shaft L 35/21mm shaft flat upper/ lower suitable for PEL22			
<b>accessories for</b> 106040				
	Part No.	100944	Ref. No.	—
	union nut thread M18x1.5 for pipe ø 12mm			
	Part No.	101273	Ref. No.	93107
	olive for pipe ø 12mm L 9.5mm brass Qty 1 pcs suitable for universal			





1



<b>Part No.</b>	101625	<b>Ref. No.</b>	94412
<b>description</b>	gas tap alternatives to EGA type GPEL22D with nozzle outlet (without nozzle) gas inlet M18x1.5 (tube ø 12mm) external nozzle ømm internal nozzle ømm bypass nozzle ø 0.35mm mixing pipe connection M22x1 thermocouple connection M8x1 pilot connection M10x1 shaft ø 6.5x9mm shaft L 34/15mm shaft flat right and left		
<b>spare parts for</b>	101625		
	<b>Part No.</b>	100259	<b>Ref. No.</b> —
	bypass nozzle type PEL22 bore ø 0.35mm thread M6x0.5		
	<b>Part No.</b>	100927	<b>Ref. No.</b> —
	torsion spring L 2.8-8.0mm for internal nozzle ø 3mm bore ømm		
	<b>Part No.</b>	101058	<b>Ref. No.</b> 93122
	magnet unit L 39mm D1 ø 15.4mm D2 ø 13.5mm suitable for PEL22/ EGA24197 standard		
	<b>Part No.</b>	101230	<b>Ref. No.</b> —
	thermocouple nut T1: M8x1 T2: M18x1 aluminium		
	<b>Part No.</b>	101460	<b>Ref. No.</b> —
	O-ring ø 12.37mm D1 ø 2.62mm suitable for PEL22		
	<b>Part No.</b>	101527	<b>Ref. No.</b> —
	O-ring Viton thickness 1.78mm ID ø 6.75mm Qty 1 pcs		
	<b>Part No.</b>	101594	<b>Ref. No.</b> —
	adjusting screw for internal nozzle thread M10x0.75		
	<b>Part No.</b>	101822	<b>Ref. No.</b> —
	gas tap front part shaft ø 10x6.5mm shaft L 34/15mm shaft flat right/ left suitable for PEL22		
<b>accessories for</b>	101625		
	<b>Part No.</b>	100908	<b>Ref. No.</b> —
	union screw thread M10x1 for pipe ø 4mm Qty 1 pcs		
	<b>Part No.</b>	100909	<b>Ref. No.</b> —
	union screw thread M10x1 for pipe ø 6mm Qty 1 pcs		
	<b>Part No.</b>	100944	<b>Ref. No.</b> —
	union nut thread M18x1.5 for pipe ø 12mm		
	<b>Part No.</b>	101246	<b>Ref. No.</b> —
	olive for pipe ø 4mm Qty 1 pcs		
	<b>Part No.</b>	101273	<b>Ref. No.</b> 93107
	olive for pipe ø 12mm L 9.5mm brass Qty 1 pcs suitable for universal		
	<b>Part No.</b>	101286	<b>Ref. No.</b> —
	olive ID ø 6mm Qty 1 pcs		

1

<b>Part No.</b>	106395	<b>Ref. No.</b>	94701
<b>description</b>	gas tap alternatives to EGA type GPEL22D with nozzle outlet (without nozzle) gas inlet M18x1.5 (tube ø 12mm) external nozzle ømm internal nozzle ømm bypass nozzle ø 0.35mm mixing pipe connection M22x1 thermocouple connection M8x1 pilot connection M10x1 shaft ø 6.5x9mm shaft L 34/15mm shaft flat right and left		
<b>spare parts for</b>	106395		
	<b>Part No.</b>	100259	<b>Ref. No.</b> —
	bypass nozzle type PEL22 bore ø 0.35mm thread M6x0.5		
	<b>Part No.</b>	100927	<b>Ref. No.</b> —
	torsion spring L 2.8-8.0mm for internal nozzle ø 3mm bore ømm		
	<b>Part No.</b>	101058	<b>Ref. No.</b> 93122
	magnet unit L 39mm D1 ø 15.4mm D2 ø 13.5mm suitable for PEL22/ EGA24197 standard		
	<b>Part No.</b>	101230	<b>Ref. No.</b> —
	thermocouple nut T1: M8x1 T2: M18x1 aluminium		
	<b>Part No.</b>	101460	<b>Ref. No.</b> —
	O-ring ø 12.37mm D1 ø 2.62mm suitable for PEL22		
	<b>Part No.</b>	101527	<b>Ref. No.</b> —
	O-ring Viton thickness 1.78mm ID ø 6.75mm Qty 1 pcs		
	<b>Part No.</b>	101594	<b>Ref. No.</b> —
	adjusting screw for internal nozzle thread M10x0.75		
<b>accessories for</b>	106395		
	<b>Part No.</b>	100908	<b>Ref. No.</b> —
	union screw thread M10x1 for pipe ø 4mm Qty 1 pcs		
	<b>Part No.</b>	100909	<b>Ref. No.</b> —
	union screw thread M10x1 for pipe ø 6mm Qty 1 pcs		
	<b>Part No.</b>	100944	<b>Ref. No.</b> —
	union nut thread M18x1.5 for pipe ø 12mm		
	<b>Part No.</b>	101246	<b>Ref. No.</b> —
	olive for pipe ø 4mm Qty 1 pcs		
	<b>Part No.</b>	101273	<b>Ref. No.</b> 93107
	olive for pipe ø 12mm L 9.5mm brass Qty 1 pcs suitable for universal		
	<b>Part No.</b>	101286	<b>Ref. No.</b> —
	olive ID ø 6mm Qty 1 pcs		



			
1			
<b>Part No.</b>	106678	<b>Ref. No.</b>	94701-01
<b>description</b>	gas tap alternatives to EGA type GPEL22D with nozzle outlet (without nozzle) gas inlet M18x1.5 (tube ø 12mm) external nozzle ømm internal nozzle ømm bypass nozzle ø 0.35mm mixing pipe connection M22x1 thermocouple connection M8x1 pilot connection M10x1 shaft ø 9x6.5mm shaft L 29/12mm shaft flat right and left shaft length knob 15mm		
<b>spare parts for</b>	106678		
	<b>Part No.</b>	100390	<b>Ref. No.</b> 94452
	bypass nozzle type PEL22 bore ø 0.5mm thread M6x0.5		
	<b>Part No.</b>	101058	<b>Ref. No.</b> 93122
	magnet unit L 39mm D1 ø 15.4mm D2 ø 13.5mm suitable for PEL22/ EGA24197 standard		
	<b>Part No.</b>	101230	<b>Ref. No.</b> —
	thermocouple nut T1: M8x1 T2: M18x1 aluminium		
<b>accessories for</b>	106678		
	<b>Part No.</b>	100908	<b>Ref. No.</b> —
	union screw thread M10x1 for pipe ø 4mm Qty 1 pcs		
	<b>Part No.</b>	100909	<b>Ref. No.</b> —
	union screw thread M10x1 for pipe ø 6mm Qty 1 pcs		
	<b>Part No.</b>	100944	<b>Ref. No.</b> —
	union nut thread M18x1.5 for pipe ø 12mm		
	<b>Part No.</b>	101246	<b>Ref. No.</b> —
	olive for pipe ø 4mm Qty 1 pcs		
	<b>Part No.</b>	101273	<b>Ref. No.</b> 93107
	olive for pipe ø 12mm L 9.5mm brass Qty 1 pcs suitable for universal		
	<b>Part No.</b>	101286	<b>Ref. No.</b> —
	olive ID ø 6mm Qty 1 pcs		

			
1			
<b>Part No.</b>	106679	<b>Ref. No.</b>	94700-01
<b>description</b>	gas tap alternatives to EGA type GPEL22D with nozzle outlet (without nozzle) gas inlet M18x1.5 (tube ø 12mm) external nozzle ømm internal nozzle ømm bypass nozzle ø 0.35mm mixing pipe connection M22x1 thermocouple connection M8x1 pilot connection M10x1 shaft ø 9x6.5mm shaft L 34/15mm shaft flat upper and bottom		
<b>spare parts for</b>	106679		
	<b>Part No.</b>	100390	<b>Ref. No.</b> 94452
	bypass nozzle type PEL22 bore ø 0.5mm thread M6x0.5		

<b>spare parts for</b>	106679		
	<b>Part No.</b>	101058	<b>Ref. No.</b> 93122
	magnet unit L 39mm D1 ø 15.4mm D2 ø 13.5mm suitable for PEL22/ EGA24197 standard		
	<b>Part No.</b>	101230	<b>Ref. No.</b> —
	thermocouple nut T1: M8x1 T2: M18x1 aluminium		
	<b>Part No.</b>	101823	<b>Ref. No.</b> —
	gas tap front part shaft ø 6x4.6mm shaft L 35/21mm shaft flat upper/ lower suitable for PEL22		
<b>accessories for</b>	106679		
	<b>Part No.</b>	100908	<b>Ref. No.</b> —
	union screw thread M10x1 for pipe ø 4mm Qty 1 pcs		
	<b>Part No.</b>	101246	<b>Ref. No.</b> —
	olive for pipe ø 4mm Qty 1 pcs		





















			
1			
<b>Part No.</b>	106394	<b>Ref. No.</b>	94700
<b>description</b>	gas tap alternatives to EGA type GPEL22D with nozzle outlet (without nozzle) gas inlet M18x1.5 (tube ø 12mm) external nozzle ømm internal nozzle ømm bypass nozzle ø 0.5mm mixing pipe connection M22x1 thermocouple connection M8x1 pilot connection M10x1 shaft ø 9x6.5mm shaft L 26/15mm shaft flat upper and bottom		
<b>spare parts for</b>	106394		
	<b>Part No.</b>	100259	<b>Ref. No.</b> —
	bypass nozzle type PEL22 bore ø 0.35mm thread M6x0.5		
	<b>Part No.</b>	100927	<b>Ref. No.</b> —
	torsion spring L 2.8-8.0mm for internal nozzle ø 3mm bore ømm		
	<b>Part No.</b>	101058	<b>Ref. No.</b> 93122
	magnet unit L 39mm D1 ø 15.4mm D2 ø 13.5mm suitable for PEL22/ EGA24197 standard		
	<b>Part No.</b>	101230	<b>Ref. No.</b> —
	thermocouple nut T1: M8x1 T2: M18x1 aluminium		
	<b>Part No.</b>	101460	<b>Ref. No.</b> —
	O-ring ø 12.37mm D1 ø 2.62mm suitable for PEL22		
	<b>Part No.</b>	101527	<b>Ref. No.</b> —
	O-ring Viton thickness 1.78mm ID ø 6.75mm Qty 1 pcs		
	<b>Part No.</b>	101594	<b>Ref. No.</b> —
	adjusting screw for internal nozzle thread M10x0.75		
<b>accessories for</b>	106394		
	<b>Part No.</b>	100908	<b>Ref. No.</b> —
	union screw thread M10x1 for pipe ø 4mm Qty 1 pcs		
	<b>Part No.</b>	100909	<b>Ref. No.</b> —
	union screw thread M10x1 for pipe ø 6mm Qty 1 pcs		

Table continues overleaf



accessories for		106394		
Part No.	100944	Ref. No.	—	
	union nut	thread M18x1.5 for pipe ø 12mm		
	olive	for pipe ø 4mm Qty 1 pcs		
	olive	for pipe ø 12mm L 9.5mm brass Qty 1 pcs suitable for universal	93107	
	olive	ID ø 6mm Qty 1 pcs	—	
	knob	gas tap with ignition flame ø 64mm shaft ø 9x7mm shaft flat horizontal black	—	

accessories for		101624		
Part No.	100944	Ref. No.	—	
	union nut	thread M18x1.5 for pipe ø 12mm		
	olive	for pipe ø 4mm Qty 1 pcs		
	olive	for pipe ø 12mm L 9.5mm brass Qty 1 pcs suitable for universal	93107	
	olive	ID ø 6mm Qty 1 pcs	—	
	knob	gas tap with ignition flame ø 64mm shaft ø 9x7mm shaft flat horizontal black	—	

				
1				
Part No.	101624	Ref. No.	94411	
description	gas tap alternatives to EGA type PEL22S with nozzle outlet (without nozzle) gas inlet M18x1.5 (tube ø 12mm) external nozzle ømm internal nozzle ømm bypass nozzle ø 0.35mm mixing pipe connection M22x1 thermocouple connection M8x1 pilot connection M10x1 shaft ø 9x6.5mm shaft L 34/15mm shaft flat upper and bottom			
spare parts for	101624			
	Part No.	100259	Ref. No.	—
	bypass nozzle type PEL22 bore ø 0.35mm thread M6x0.5			
	Part No.	100927	Ref. No.	—
	torsion spring L 2.8-8.0mm for internal nozzle ø 3mm bore ømm			
	Part No.	101058	Ref. No.	93122
	magnet unit L 39mm D1 ø 15.4mm D2 ø 13.5mm suitable for PEL22/ EGA24197 standard			
	Part No.	101230	Ref. No.	—
	thermocouple nut T1: M8x1 T2: M18x1 aluminium			
	Part No.	101460	Ref. No.	—
	O-ring ø 12.37mm D1 ø 2.62mm suitable for PEL22			
	Part No.	101527	Ref. No.	—
	O-ring Viton thickness 1.78mm ID ø 6.75mm Qty 1 pcs			
	Part No.	101594	Ref. No.	—
	adjusting screw for internal nozzle thread M10x0.75			
	Part No.	101821	Ref. No.	—
	gas tap front part shaft ø 9x6.5mm shaft L 34/15mm shaft flat upper/ lower suitable for PEL22			
accessories for	101624			
	Part No.	100908	Ref. No.	—
	union screw thread M10x1 for pipe ø 4mm Qty 1 pcs			
	Part No.	100909	Ref. No.	—
	union screw thread M10x1 for pipe ø 6mm Qty 1 pcs			









with pipe outlet				
				
1				
Part No.	101666	Ref. No.	94413	
description	gas tap alternatives to EGA type GPEL22R with pipe outlet gas inlet M18x1.5 (tube ø 12mm) bypass nozzle ø 0.35mm gas outlet M18x1.5 (tube ø 12mm) thermocouple connection M8x1 pilot connection M10x1 shaft ø 9x6.5mm shaft L 34/15mm shaft flat right/left			
spare parts for	101666			
	Part No.	100259	Ref. No.	—
	bypass nozzle type PEL22 bore ø 0.35mm thread M6x0.5			
	Part No.	101058	Ref. No.	93122
	magnet unit L 39mm D1 ø 15.4mm D2 ø 13.5mm suitable for PEL22/ EGA24197 standard			
	Part No.	101230	Ref. No.	—
	thermocouple nut T1: M8x1 T2: M18x1 aluminium			
	Part No.	101460	Ref. No.	—
	O-ring ø 12.37mm D1 ø 2.62mm suitable for PEL22			
	Part No.	101822	Ref. No.	—
	gas tap front part shaft ø 10x6.5mm shaft L 34/15mm shaft flat right/ left suitable for PEL22			
accessories for	101666			
	Part No.	100908	Ref. No.	—
	union screw thread M10x1 for pipe ø 4mm Qty 1 pcs			
	Part No.	100909	Ref. No.	—
	union screw thread M10x1 for pipe ø 6mm Qty 1 pcs			
	Part No.	100944	Ref. No.	—
	union nut thread M18x1.5 for pipe ø 12mm			
	Part No.	101246	Ref. No.	—
	olive for pipe ø 4mm Qty 1 pcs			



Table continues overleaf





<b>accessories for</b>	101666		
	Part No.	101273	Ref. No. 93107
	olive for pipe ø 12mm L 9.5mm brass Qty 1 pcs suitable for universal		
	Part No.	101286	Ref. No. —
	olive ID ø 6mm Qty 1 pcs		

## alternatives to JUNKERS

	1		
<b>Part No.</b>	101630	<b>Ref. No.</b>	94600
<b>description</b>	gas tap PEL type 23S/V gas inlet 1/2" IT bypass nozzle ø 0.35mm gas outlet 1/2" MT (tube ø 14mm) thermocouple connection M10x1 pilot connection M10x1 shaft ø 10mm shaft L 25mm shaft flat		
<b>spare parts for</b>	101630		
	Part No.	100455	Ref. No. —
	bypass nozzle type PEL23/24 bore ø 0.35mm thread M8x0.5		
	Part No.	101059	Ref. No. 94615
	magnet unit T1: M10x1 T2: M22x1 L 46mm ø 18mm suitable for PEL23S M10x1		
	Part No.	102767	Ref. No. —
	gas tap front part shaft ø 10mm shaft L 26.5mm shaft flat suitable for PEL23S		
<b>accessories for</b>	101630		
	Part No.	100908	Ref. No. —
	union screw thread M10x1 for pipe ø 4mm Qty 1 pcs		
	Part No.	100909	Ref. No. —
	union screw thread M10x1 for pipe ø 6mm Qty 1 pcs		
	Part No.	100945	Ref. No. —
	roll pin ø 3.2mm L 10mm		
	Part No.	101218	Ref. No. —
	shaft extension JUNKERS		
	Part No.	101219	Ref. No. —
	shaft extension L 25mm JUNKERS		
	Part No.	101246	Ref. No. —
	olive for pipe ø 4mm Qty 1 pcs		
	Part No.	101286	Ref. No. —
	olive ID ø 6mm Qty 1 pcs		
	Part No.	110064	Ref. No. 93207
	knob		
	Part No.	110066	Ref. No. —
	knob screw		
	Part No.	550396	Ref. No. —
	shaft extension L 25mm JUNKERS		

## MADEC (MP)

with nozzle outlet



<b>Part No.</b>	101073	<b>Ref. No.</b>	93618
<b>description</b>	gas tap MADEC with nozzle outlet (without nozzle) gas inlet M12x1 (tube ø 8mm) external nozzle ømm internal nozzle ømm bypass nozzle ø 0.35mm mixing pipe connection M17x1 thermocouple connection M8x1 front fixing M12x1 shaft ø 8x5mm shaft L 23/13.5mm shaft flat right gas outlet M17x1		
<b>spare parts for</b>	101073		
	Part No.	100936	Ref. No. —
	gas tap spindle shaft ø 5x8mm MADEC		
	Part No.	101051	Ref. No. —
	magnet unit L 27mm D1 ø 12.5mm D2 ø 8.5mm suitable for JUNKERS/EGA/MADEC/SABAF standard		
	Part No.	101234	Ref. No. —
	union nut T1: M8x1 T2: M15		
<b>accessories for</b>	101073		
	Part No.	100927	Ref. No. —
	torsion spring L 2.8-8.0mm for internal nozzle ø 3mm bore ømm		
	Part No.	101277	Ref. No. 93106
	olive ID ø 8mm Qty 1 pcs		
	Part No.	101296	Ref. No. —
	union nut thread M12x1 for pipe ø 8mm		
	Part No.	101299	Ref. No. —
	nut thread M12x1		
	Part No.	101400	Ref. No. —
	air mixing tube thread M17x1 suitable for L350, L700		
	Part No.	110148	Ref. No. —
	knob gas tap without ignition flame ø 50mm shaft ø 8x5mm shaft flat left black		
	Part No.	110150	Ref. No. 93118
	knob gas tap without ignition flame t.max. °C ø 50mm shaft ø 8x5.5mm shaft flat right white		







gas thermostats

SIT

710 Minisit series



<b>Part No.</b>	101385	<b>Ref. No.</b>	93201
<b>description</b>	gas thermostat SIT type MINISIT 710 t.max. 200°C 60-200°C gas inlet 3/8" gas outlet 3/8" thermocouple connection M10x1 pilot connection M10x1 probe ø 5mm probe L 95mm capillary pipe 1050mm probe type type D2 pressure controller no pressure regulator mbar gland nut M14x1.5 ignition gas 4mm		
<b>spare parts for</b>	101385		
	<b>Part No.</b>	100809	<b>Ref. No.</b> —
	O-ring EPDM thickness 2mm ID ø 21mm Qty 1 pcs		
	<b>Part No.</b>	100904	<b>Ref. No.</b> —
	locking screw M10x1 for pipe ø 4mm Qty 1 pcs		
	<b>Part No.</b>	101054	<b>Ref. No.</b> —
	magnet unit T1: M10x1 T2: M24x1 L 45mm ø 17mm suitable for Minisit		
	<b>Part No.</b>	101136	<b>Ref. No.</b> —
	piezoelectric igniter suitable for Minisit with cover cap ømm connection F6.3x0.8		
	<b>Part No.</b>	101268	<b>Ref. No.</b> —
	gas connection thread 3/8" angled with O-ring MINISIT 710		
	<b>Part No.</b>	101273	<b>Ref. No.</b> 93107
	olive for pipe ø 12mm L 9.5mm brass Qty 1 pcs suitable for universal		
	<b>Part No.</b>	101276	<b>Ref. No.</b> —
	union screw thread 3/8" tube ø 12mm Qty 1 pcs		
	<b>Part No.</b>	102844	<b>Ref. No.</b> —
	probe 60-200°C probe ø 5mm probe L 98mm capillary pipe 1050mm t.max. 200°C fryer probe type type D2 suitable for MINISIT 710 gland nut M14x1.5		
<b>accessories for</b>	101385		
	<b>Part No.</b>	100905	<b>Ref. No.</b> —
	locking screw M10x1 for pipe ø 6mm Qty 1 pcs		
	<b>Part No.</b>	101054	<b>Ref. No.</b> —
	magnet unit T1: M10x1 T2: M24x1 L 45mm ø 17mm suitable for Minisit		
	<b>Part No.</b>	101137	<b>Ref. No.</b> —
	cover cap without piezoelectric igniter		
	<b>Part No.</b>	101267	<b>Ref. No.</b> —
	reducer IT 3/8" ET 1/2" L 21mm		
	<b>Part No.</b>	101269	<b>Ref. No.</b> —
	gas connection thread 1/2" angled with O-ring MINISIT 710		

<b>accessories for</b>	101385		
	<b>Part No.</b>	101270	<b>Ref. No.</b> —
	screw connection IT 3/8" ET 3/8" L 28mm		
	<b>Part No.</b>	101272	<b>Ref. No.</b> —
	screw connection IT 1/2" ET 3/8" L 57mm		
	<b>Part No.</b>	101274	<b>Ref. No.</b> —
	olive for pipe ø 16mm Qty 1 pcs		
	<b>Part No.</b>	101275	<b>Ref. No.</b> —
	union screw thread 1/2" for pipe ø 16mm Qty 1 pcs		









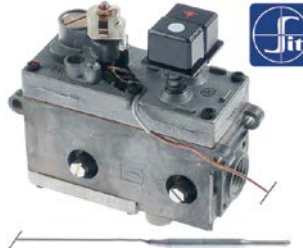

	<b>Part No.</b>	101132	<b>Ref. No.</b>	26001
<b>description</b>	gas thermostat SIT type MINISIT 710 t.max. 340°C 100-340°C gas inlet 1/2" gas outlet 3/8" thermocouple connection M9x1 pilot connection M10x1 probe ø 5mm probe L 68mm capillary pipe 1050mm probe type type B1 pressure controller no pressure regulator mbar gland nut ignition gas no			
<b>spare parts for</b>	101132			
	<b>Part No.</b>	101053	<b>Ref. No.</b>	—
	magnet unit T1: M9x1 T2: M24x1 L 45mm ø 17mm suitable for Minisit			
	<b>Part No.</b>	102102	<b>Ref. No.</b>	—
	probe 100-340°C probe ø 5mm probe L 68mm capillary pipe 1750mm t.max. 340°C oven/grill probe type type B1 suitable for MINISIT 710			
<b>accessories for</b>	101132			
	<b>Part No.</b>	100809	<b>Ref. No.</b>	—
	O-ring EPDM thickness 2mm ID ø 21mm Qty 1 pcs			
	<b>Part No.</b>	100904	<b>Ref. No.</b>	—
	locking screw M10x1 for pipe ø 4mm Qty 1 pcs			
	<b>Part No.</b>	100905	<b>Ref. No.</b>	—
	locking screw M10x1 for pipe ø 6mm Qty 1 pcs			
	<b>Part No.</b>	101054	<b>Ref. No.</b>	—
	magnet unit T1: M10x1 T2: M24x1 L 45mm ø 17mm suitable for Minisit			
	<b>Part No.</b>	101136	<b>Ref. No.</b>	—
	piezoelectric igniter suitable for Minisit with cover cap ømm connection F6.3x0.8			
	<b>Part No.</b>	101137	<b>Ref. No.</b>	—
	cover cap without piezoelectric igniter			
	<b>Part No.</b>	101267	<b>Ref. No.</b>	—
	reducer IT 3/8" ET 1/2" L 21mm			
	<b>Part No.</b>	101268	<b>Ref. No.</b>	—
	gas connection thread 3/8" angled with O-ring MINISIT 710			

Table continues overleaf







accessories for		101132	
	Part No.	101269	Ref. No. —
gas connection thread 1/2" angled with O-ring MINISIT 710			
	Part No.	101270	Ref. No. —
screw connection IT 3/8" ET 3/8" L 28mm			
	Part No.	101272	Ref. No. —
screw connection IT 1/2" ET 3/8" L 57mm			
	Part No.	101273	Ref. No. 93107
olive for pipe ø 12mm L 9.5mm brass Qty 1 pcs suitable for universal			
	Part No.	101274	Ref. No. —
olive for pipe ø 16mm Qty 1 pcs			
	Part No.	101275	Ref. No. —
union screw thread 1/2" for pipe ø 16mm Qty 1 pcs			
	Part No.	101276	Ref. No. —
union screw thread 3/8" tube ø 12mm Qty 1 pcs			
	Part No.	110068	Ref. No. 26001
knob suitable for Minisit ø 37mm			

## gas valves and ignition boxes

### safety valves

#### ORKLI/JUNKERS



1			
<b>Part No.</b>	101196	<b>Ref. No.</b>	93273
<b>description</b>	safety valve type CV101015 front fixing M12x0.75 pressure rangembar pressure range 2.1bar gas inlet M14x1.5 ET gas outlet ø 8mm thermocouple connection M8x1		
<b>spare parts for</b>	101196		
	Part No.	101046	Ref. No. —
magnet unit L 27mm D1 ø 12.5mm D2 ø 9.5mm pressure range 2.1bar suitable for JUNKERS			
<b>accessories for</b>	101196		
	Part No.	101499	Ref. No. 93822
protection cap for safety valve thread M12x0.75 ID ø 18mm L 24mm aluminium			
	Part No.	101501	Ref. No. 93282
nut thread M12x0.75 H 2mm WS 16 brass Qty 1 pcs			

## ignition parts

### pilot burners

#### JUNKERS

#### CB 503 series

#### pilot burners

















1			
<b>Part No.</b>	100101	<b>Ref. No.</b>	93269
<b>description</b>	pilot burner JUNKERS type CB503003 LPG nozzle no.2 gas connection 4mm with primary air		
<b>spare parts for</b>	100101		
	Part No.	100224	Ref. No. —
pilot burner nozzle natural gas gas pressure 25mbar code 26 Qty 1 pcs suitable for JUNKERS CB503_			
	Part No.	101281	Ref. No. 91606
olive for pipe ø 4mm L 8.7mm Qty 1 pcs suitable for CB 502/503			
	Part No.	101283	Ref. No. —
union screw thread M10x1 for pipe ø 4mm Qty 1 pcs			
<b>accessories for</b>	100101		
	Part No.	100220	Ref. No. —
pilot burner nozzle LPG gas pressure 50mbar code 2 Qty 1 pcs suitable for JUNKERS CB503_			
	Part No.	100221	Ref. No. —
pilot burner nozzle LPG gas pressure 30mbar code 29 Qty 1 pcs suitable for JUNKERS CB50203_			
	Part No.	100222	Ref. No. —
pilot burner nozzle LPG gas pressure 50mbar code 5 Qty 1 pcs suitable for JUNKERS CB50203_			
	Part No.	100223	Ref. No. —
pilot burner nozzle natural gas gas pressure 20mbar code 3 Qty 1 pcs suitable for JUNKERS CB503_			
	Part No.	100226	Ref. No. —
pilot burner nozzle LPG gas pressure 50mbar code 15 suitable for JUNKERS			
	Part No.	100227	Ref. No. —
pilot burner nozzle natural gas gas pressure 25mbar code 6 Qty 1 pcs suitable for JUNKERS CB50203_			
	Part No.	100228	Ref. No. —
pilot burner nozzle town gas gas pressure 8mbar code 4 Qty 1 pcs suitable for JUNKERS CB50203_			
	Part No.	100909	Ref. No. —
union screw thread M10x1 for pipe ø 6mm Qty 1 pcs			
	Part No.	101287	Ref. No. —
olive for pipe ø 6mm Qty 1 pcs			
	Part No.	102110	Ref. No. —
pilot tube copper pipe ø 4mm thickness 1mm L 3000mm			

Table continues overleaf



accessories for	100101		
Part No.	102111	Ref. No.	—
pilot tube copper pipe $\varnothing$ 6mm thickness 1mm L 3000mm			

## producer-specific pilot burners

### HEIDEBRENNER



Part No.	102859	Ref. No.	8620FG
description	pilot burner LPG		



Part No.	102860	Ref. No.	8620EG
description	pilot burner natural gas		



Part No.	106959	Ref. No.	8618
description	pilot burner without nozzle		

## electrodes

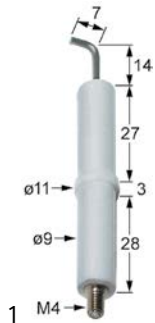

Part No.	102863	Ref. No.	93292
description	ignition electrode D1 $\varnothing$ 9mm connection M4 D2 $\varnothing$ 11mm L1 14mm L2 7mm BL1 27mm BL2 3mm BL3 28mm to clip		
For models:	AGK 13		

## piezoelectric igniters

### mounting diameter 22mm



Part No.	100008	Ref. No.	93285
description	piezoelectric igniter body plastic blowing mounting $\varnothing$ 22mm connection $\varnothing$ 2mm cable lengthmm		
For models:	AGK 13		

## thermocouples

### plug-in thermocouples

#### plug-in thermocouples standard

#### with barrel socket $\varnothing$ 6mm

#### type Junkers with aluminised tip

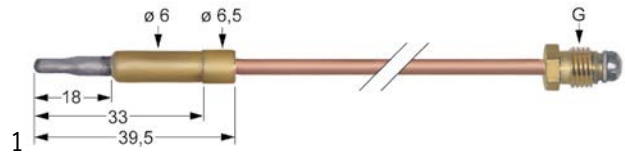

Part No.	102229	Ref. No.	93262
description	thermocouple M10x1 L 1000mm plug connection $\varnothing$ 6.0mm		

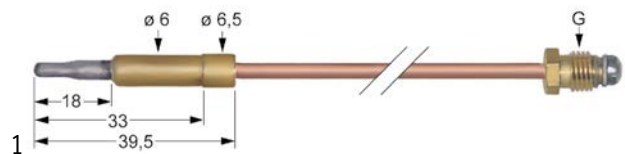

Part No.	102230	Ref. No.	93263
description	thermocouple M10x1 L 1200mm plug connection $\varnothing$ 6.0mm		

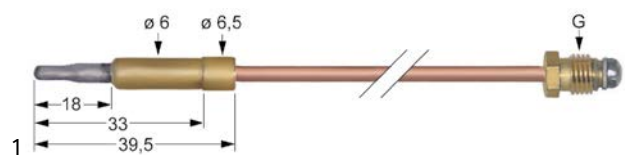

Part No.	102231	Ref. No.	93264
description	thermocouple M10x1 L 1500mm plug connection $\varnothing$ 6.0mm		

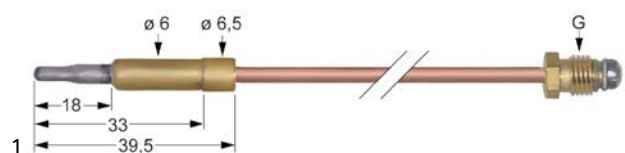

Part No.	102225	Ref. No.	93258
description	thermocouple M10x1 L 320mm plug connection $\varnothing$ 6.0mm		



<b>Part No.</b>	102226	<b>Ref. No.</b>	93259
<b>description</b>	thermocouple M10x1 L 450mm plug connection ø6.0mm		

<b>Part No.</b>	102227	<b>Ref. No.</b>	93260
<b>description</b>	thermocouple M10x1 L 600mm plug connection ø6.0mm		

<b>Part No.</b>	102228	<b>Ref. No.</b>	93261
<b>description</b>	thermocouple M10x1 L 750mm plug connection ø6.0mm		

<b>Part No.</b>	102222	<b>Ref. No.</b>	93250
<b>description</b>	thermocouple M8x1 L 1000mm plug connection ø6.0mm		

<b>Part No.</b>	102223	<b>Ref. No.</b>	93251
<b>description</b>	thermocouple M8x1 L 1200mm plug connection ø6.0mm		

<b>Part No.</b>	102217	<b>Ref. No.</b>	93243
<b>description</b>	thermocouple M8x1 L 220mm plug connection ø6.0mm		

<b>Part No.</b>	102218	<b>Ref. No.</b>	93245
<b>description</b>	thermocouple M8x1 L 320mm plug connection ø6.0mm		

<b>Part No.</b>	102219	<b>Ref. No.</b>	93246
<b>description</b>	thermocouple M8x1 L 450mm plug connection ø6.0mm		

<b>Part No.</b>	102220	<b>Ref. No.</b>	93247
<b>description</b>	thermocouple M8x1 L 600mm plug connection ø6.0mm		

<b>Part No.</b>	102221	<b>Ref. No.</b>	93248
<b>description</b>	thermocouple M8x1 L 750mm plug connection ø6.0mm		

threaded thermocouples

threaded thermocouples standard

with socket with thread M8x1

SIT

<b>Part No.</b>	107645	<b>Ref. No.</b>	93256 93257
<b>description</b>	thermocouple SIT M10x1 L 1500mm M8x1		
<b>accessories for</b>	107645		
	<b>Part No.</b>	102067	<b>Ref. No.</b> 93123
	nut thread M8x1 H 3mm brass Qty 1 pcs type SEF 1		

<b>Part No.</b>	107642	<b>Ref. No.</b>	93253
<b>description</b>	thermocouple SIT M10x1 L 450mm M8x1		
<b>accessories for</b>	107642		
	<b>Part No.</b>	102067	<b>Ref. No.</b> 93123
	nut thread M8x1 H 3mm brass Qty 1 pcs type SEF 1		





<b>Part No.</b>	107643	<b>Ref. No.</b>	93254
<b>description</b>	thermocouple SIT M10x1 L 600mm M8x1		
<b>accessories for</b>	107643		
	<b>Part No.</b>	102067	<b>Ref. No.</b> 93123
	nut thread M8x1 H 3mm brass Qty 1 pcs type SEF 1		

<b>Part No.</b>	107634	<b>Ref. No.</b>	93240
<b>description</b>	thermocouple SIT M8x1 L 1500mm M8x1		
<b>accessories for</b>	107634		
	<b>Part No.</b>	102067	<b>Ref. No.</b> 93123
	nut thread M8x1 H 3mm brass Qty 1 pcs type SEF 1		

<b>Part No.</b>	107644	<b>Ref. No.</b>	93255
<b>description</b>	thermocouple SIT M10x1 L 750mm M8x1		
<b>accessories for</b>	107644		
	<b>Part No.</b>	102067	<b>Ref. No.</b> 93123
	nut thread M8x1 H 3mm brass Qty 1 pcs type SEF 1		

<b>Part No.</b>	107627	<b>Ref. No.</b>	93255
<b>description</b>	thermocouple SIT M8x1 L 220mm M8x1		

<b>Part No.</b>	107632	<b>Ref. No.</b>	93241
<b>description</b>	thermocouple SIT M8x1 L 1000mm M8x1		
<b>accessories for</b>	107632		
	<b>Part No.</b>	102067	<b>Ref. No.</b> 93123
	nut thread M8x1 H 3mm brass Qty 1 pcs type SEF 1		

<b>Part No.</b>	107628	<b>Ref. No.</b>	93236
<b>description</b>	thermocouple SIT M8x1 L 320mm M8x1		
<b>accessories for</b>	107628		
	<b>Part No.</b>	102067	<b>Ref. No.</b> 93123
	nut thread M8x1 H 3mm brass Qty 1 pcs type SEF 1		

<b>Part No.</b>	107633	<b>Ref. No.</b>	93242
<b>description</b>	thermocouple SIT M8x1 L 1200mm M8x1		
<b>accessories for</b>	107633		
	<b>Part No.</b>	102067	<b>Ref. No.</b> 93123
	nut thread M8x1 H 3mm brass Qty 1 pcs type SEF 1		

<b>Part No.</b>	107629	<b>Ref. No.</b>	93237
<b>description</b>	thermocouple SIT M8x1 L 450mm M8x1		
<b>accessories for</b>	107629		
	<b>Part No.</b>	102067	<b>Ref. No.</b> 93123
	nut thread M8x1 H 3mm brass Qty 1 pcs type SEF 1		

<b>Part No.</b>	107640	<b>Ref. No.</b>	93206
<b>description</b>	thermocouple SIT M9x1 L 1500mm M8x1		



<b>Part No.</b>	107636	<b>Ref. No.</b>	93271
<b>description</b>	thermocouple SIT M9x1 L 600mm M8x1		
<b>accessories for</b>	107636		
	<b>Part No.</b>	<b>Ref. No.</b>	93123
	nut thread M8x1 H 3mm brass Qty 1 pcs type SEF 1		

<b>Part No.</b>	107637	<b>Ref. No.</b>	93244
<b>description</b>	thermocouple SIT M9x1 L 850mm M8x1		
<b>accessories for</b>	107637		
	<b>Part No.</b>	<b>Ref. No.</b>	93123
	nut thread M8x1 H 3mm brass Qty 1 pcs type SEF 1		

type Junkers with aluminised tip

<b>Part No.</b>	102234	<b>Ref. No.</b>	93252
<b>description</b>	thermocouple M10x1 L 320mm M8x1		

<b>Part No.</b>	102056	<b>Ref. No.</b>	93238
<b>description</b>	thermocouple M8x1 L 600mm M8x1		
<b>accessories for</b>	102056		
	<b>Part No.</b>	<b>Ref. No.</b>	93123
	nut thread M8x1 H 3mm brass Qty 1 pcs type SEF 1		

<b>Part No.</b>	102233	<b>Ref. No.</b>	93239
<b>description</b>	thermocouple M8x1 L 750mm M8x1		
<b>accessories for</b>	102233		
	<b>Part No.</b>	<b>Ref. No.</b>	93123
	nut thread M8x1 H 3mm brass Qty 1 pcs type SEF 1		

accessories

nuts

<b>Part No.</b>	102067	<b>Ref. No.</b>	93123
<b>description</b>	nut thread M8x1 H 3mm brass Qty 1 pcs type SEF 1		

screws

<b>Part No.</b>	102561	<b>Ref. No.</b>	91230
<b>description</b>	thermocouple fitting thread M9x1 Qty 10 pcs		

gas burners

hob burners

producer-specific hob burners

HEIDEBRENNER

Universal series

burner caps

<b>Part No.</b>	105945	<b>Ref. No.</b>	8643
<b>description</b>	burner cap cross-shaped		

<b>Part No.</b>	105941	<b>Ref. No.</b>	8637
<b>description</b>	burner cap ø 115mm for burner cap ø 94mm		

<b>Part No.</b>	105944	<b>Ref. No.</b>	8638
<b>description</b>	burner cap ø 115mm slotted		





 <p>1</p>			
<b>Part No.</b>	105942	<b>Ref. No.</b>	8640
<b>description</b>	burner cap ø 155mm		
<b>spare parts for</b>	105942		
	<b>Part No.</b>	100222	<b>Ref. No.</b> —
	pilot burner nozzle LPG gas pressure 50mbar code 5 Qty 1 pcs suitable for JUNKERS CB50203_		
	<b>Part No.</b>	100227	<b>Ref. No.</b> —
	pilot burner nozzle natural gas gas pressure 25mbar code 6 Qty 1 pcs suitable for JUNKERS CB50203_		
	<b>Part No.</b>	102067	<b>Ref. No.</b> 93123
	nut thread M8x1 H 3mm brass Qty 1 pcs type SEF 1		
	<b>Part No.</b>	102232	<b>Ref. No.</b> —
	thermocouple M8x1 L 220mm M8x1		
	<b>Part No.</b>	102859	<b>Ref. No.</b> 8620FG
	pilot burner LPG		
	<b>Part No.</b>	102860	<b>Ref. No.</b> 8620EG
	pilot burner natural gas		
	<b>Part No.</b>	105942	<b>Ref. No.</b> 8640
	burner cap ø 155mm		

 <p>1</p>			
<b>Part No.</b>	105946	<b>Ref. No.</b>	8641
<b>description</b>	burner cap ø 155mm slotted		

 <p>1</p>			
<b>Part No.</b>	105947	<b>Ref. No.</b>	8658
<b>description</b>	burner cap ø 155mm slotted		

 <p>1</p>			
<b>Part No.</b>	104534	<b>Ref. No.</b>	98642
<b>description</b>	burner cap ø 62mm 3.5kW		

 <p>1</p>			
<b>Part No.</b>	105943	<b>Ref. No.</b>	8634
<b>description</b>	burner cap ø 91mm for burner cap ø 77mm 5.8kW		
<b>spare parts for</b>	105943		
	<b>Part No.</b>	104612	<b>Ref. No.</b> 8607
	burner unit 5.8kW without piezoelectric igniter, with pilot burner		

 <p>1</p>			
<b>Part No.</b>	104611	<b>Ref. No.</b>	8635
<b>description</b>	burner cap ø 95mm slotted		

## burner assemblies

 <p>1</p>			
<b>Part No.</b>	104728	<b>Ref. No.</b>	8606
<b>description</b>	burner unit 12.8kW with piezoelectric igniter, with pilot burner		
<b>spare parts for</b>	104728		
	<b>Part No.</b>	100013	<b>Ref. No.</b> —
	piezoelectric igniter body plastic blowing mounting ø 22mm connection ø2.4mm cable lengthmm		
	<b>Part No.</b>	100017	<b>Ref. No.</b> —
	ignition cable cable length 300mm connection ø2.4mm / ø4mm permanent temperature 200°C		
	<b>Part No.</b>	100656	<b>Ref. No.</b> 94476
	internal nozzle bore ø 1.6mm type EGA/PEL22		
	<b>Part No.</b>	100698	<b>Ref. No.</b> 94466
	gas injector thread M15x1 bore ø 3.00mm WS 17		
	<b>Part No.</b>	102054	<b>Ref. No.</b> —
	thermocouple M8x1 L 320mm M8x1		
	<b>Part No.</b>	102067	<b>Ref. No.</b> 93123
	nut thread M8x1 H 3mm brass Qty 1 pcs type SEF 1		
	<b>Part No.</b>	102859	<b>Ref. No.</b> 8620FG
	pilot burner LPG		
	<b>Part No.</b>	102863	<b>Ref. No.</b> 93292
	ignition electrode D1 ø 9mm connection M4 D2 ø 11mm L1 14mm L2 7mm BL1 27mm BL2 3mm BL3 28mm to clip		
	<b>Part No.</b>	105942	<b>Ref. No.</b> 8640
	burner cap ø 155mm		
	<b>Part No.</b>	106042	<b>Ref. No.</b> —
	gas tap type PEL22S thermocouple connection M8x1		

Table continues overleaf





<b>spare parts for</b>	104728		
Part No.	106043	Ref. No.	—
gas tap type PEL22S thermocouple connection M8x1			



<b>Part No.</b>	104727	<b>Ref. No.</b>	8609
<b>description</b>	burner unit 12.8kW without piezoelectric igniter, with pilot burner		

<b>spare parts for</b>	104727		
------------------------	--------	--	--

	Part No.	100656	Ref. No.	94476
internal nozzle bore ø 1.6mm type EGA/PEL22				

	Part No.	100698	Ref. No.	94466
gas injector thread M15x1 bore ø 3.00mm WS 17				

Part No.	102054	Ref. No.	—
----------	--------	----------	---

	thermocouple M8x1 L 320mm M8x1			
-----------------------------------------------------------------------------------	--------------------------------	--	--	--

	Part No.	102067	Ref. No.	93123
nut thread M8x1 H 3mm brass Qty 1 pcs type SEF 1				

	Part No.	102859	Ref. No.	8620FG
pilot burner LPG				

	Part No.	105942	Ref. No.	8640
burner cap ø 155mm				

	Part No.	106042	Ref. No.	—
gas tap type PEL22S thermocouple connection M8x1				

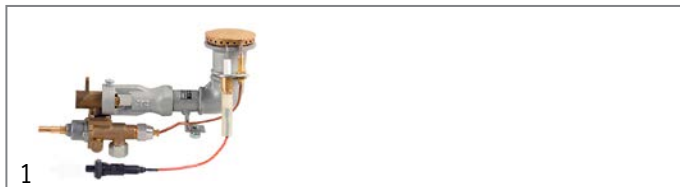



<b>Part No.</b>	104725	<b>Ref. No.</b>	8603
<b>description</b>	burner unit 3.5kW with piezoelectric igniter, no pilot burner		

<b>spare parts for</b>	104725		
------------------------	--------	--	--

	Part No.	100013	Ref. No.	—
piezoelectric igniter body plastic blowing mounting ø 22mm connection ø2.4mm cable lengthmm				

	Part No.	100017	Ref. No.	—
ignition cable cable length 300mm connection ø2.4mm / ø4mm permanent temperature 200°C				

	Part No.	100451	Ref. No.	94461
gas injector thread M15x1 bore ø 1.50mm WS 17				

	Part No.	100492	Ref. No.	94471
internal nozzle bore ø 0.8mm type EGA/PEL22				

Part No.	102054	Ref. No.	—
----------	--------	----------	---

	thermocouple M8x1 L 320mm M8x1			
-------------------------------------------------------------------------------------	--------------------------------	--	--	--

	Part No.	102067	Ref. No.	93123
nut thread M8x1 H 3mm brass Qty 1 pcs type SEF 1				

<b>spare parts for</b>	104725		
------------------------	--------	--	--

	Part No.	102863	Ref. No.	93292
ignition electrode D1 ø 9mm connection M4 D2 ø 11mm L1 14mm L2 7mm BL1 27mm BL2 3mm BL3 28mm to clip				

	Part No.	104534	Ref. No.	98642
burner cap ø 62mm 3.5kW				

Part No.	106040	Ref. No.	N/A
----------	--------	----------	-----

	gas tap alternatives to EGA type GPEL22D with nozzle outlet (without nozzle) gas inlet M18x1.5 (tube ø 12mm) external nozzle ømm internal nozzle ømm bypass nozzle ø 0.35mm mixing pipe connection M22x1 thermocouple connection M8x1 pilot connection closed shaft ø 9x6.5mm shaft L 34/15mm shaft flat upper and bottom			
-----------------------------------------------------------------------------------	---------------------------------------------------------------------------------------------------------------------------------------------------------------------------------------------------------------------------------------------------------------------------------------------------------------------------	--	--	--

Part No.	106041	Ref. No.	—
----------	--------	----------	---

	gas tap alternatives to EGA type GPEL22D with nozzle outlet (without nozzle) gas inlet M18x1.5 (tube ø 12mm) external nozzle ømm internal nozzle ømm bypass nozzle ø 0.35mm mixing pipe connection M22x1 thermocouple connection M8x1 pilot connection closed shaft ø 9x6.5mm shaft L 34/15mm shaft flat right and left			
-----------------------------------------------------------------------------------	-------------------------------------------------------------------------------------------------------------------------------------------------------------------------------------------------------------------------------------------------------------------------------------------------------------------------	--	--	--

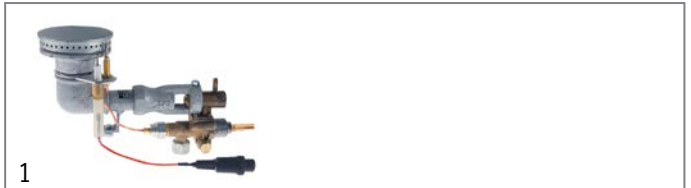

<b>Part No.</b>	104609	<b>Ref. No.</b>	8604
-----------------	--------	-----------------	------

<b>description</b>	burner unit 5.8kW with piezoelectric igniter, no pilot burner		
--------------------	---------------------------------------------------------------	--	--



<b>Part No.</b>	104612	<b>Ref. No.</b>	8607
-----------------	--------	-----------------	------

<b>description</b>	burner unit 5.8kW without piezoelectric igniter, with pilot burner		
--------------------	--------------------------------------------------------------------	--	--



<b>Part No.</b>	104610	<b>Ref. No.</b>	8605
-----------------	--------	-----------------	------

<b>description</b>	burner unit 9.3kW with piezoelectric igniter, no pilot burner		
--------------------	---------------------------------------------------------------	--	--

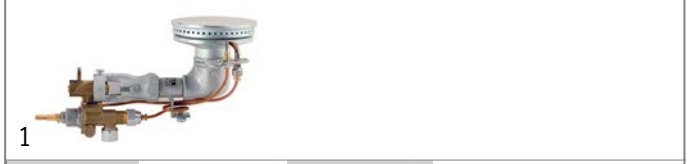

<b>Part No.</b>	104726	<b>Ref. No.</b>	8608
-----------------	--------	-----------------	------

<b>description</b>	burner unit 9.3kW without piezoelectric igniter, with pilot burner		
--------------------	--------------------------------------------------------------------	--	--

<b>spare parts for</b>	104726		
------------------------	--------	--	--

	Part No.	100101	Ref. No.	93269
pilot burner JUNKERS type CB503003 LPG nozzle no.2 gas connection 4mm with primary air				

	Part No.	100220	Ref. No.	—
pilot burner nozzle LPG gas pressure 50mbar code 2 Qty 1 pcs suitable for JUNKERS CB503_				







	Part No.	100456	Ref. No.	94464
gas injector thread M15x1 bore ø 2.50mm WS 17				

Table continues overleaf



spare parts for		104726	
	Part No.	100647	Ref. No. 94474
	internal nozzle bore $\varnothing$ 1.3mm type EGA/PEL22		
	Part No.	102019	Ref. No. —
	thermocouple M8x1 L 320mm plug connection $\varnothing$ 6.0mm		
	Part No.	105941	Ref. No. 8637
	burner cap $\varnothing$ 115mm for burner cap $\varnothing$ 94mm		
	Part No.	106042	Ref. No. —
	gas tap type PEL22S thermocouple connection M8x1		
	Part No.	106043	Ref. No. —
	gas tap type PEL22S thermocouple connection M8x1		

pan supports			
			
1			
Part No.	210234	Ref. No.	8324
description	pan support W 360mm L 365mm		

			
1			
Part No.	210233	Ref. No.	8319
description	pan support W 370mm L 370mm		

reducers for pan supports			
			
1			
Part No.	210001	Ref. No.	98.801
description	reducer for pan support L 265mm W 265mm SS suitable for universal		

spillage trays			
			
1			
Part No.	210232	Ref. No.	90601
description	drain tray L 410mm W 410mm H 70mm		

height extensions			
			
1			
Part No.	210235	Ref. No.	8360
description	attachment ring $\varnothing$ 255mm		

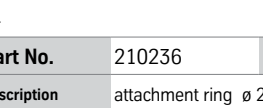
			
1			
Part No.	210236	Ref. No.	70648
description	attachment ring $\varnothing$ 255mm		

accessories			
reducers for pan supports			
			
1			
Part No.	210001	Ref. No.	98.801
description	reducer for pan support L 265mm W 265mm SS suitable for universal		

pan supports			
			
1			
Part No.	210234	Ref. No.	8324
description	pan support W 360mm L 365mm		

			
1			
Part No.	210233	Ref. No.	8319
description	pan support W 370mm L 370mm		





## spillage trays



1

<b>Part No.</b>	210232	<b>Ref. No.</b>	90601
<b>description</b>	drain tray L 410mm W 410mm H 70mm		

## air mixers



1

<b>Part No.</b>	104608	<b>Ref. No.</b>	Mischhülse
<b>description</b>	air mixing sleeve		

## ring burners



1

<b>Part No.</b>	104607	<b>Ref. No.</b>	8670
<b>description</b>	ring burner L 488mm W 150mm 2.9kW		

## gas nozzles

## main nozzles

## gas nozzles M12x1



1

<b>Part No.</b>	100307	<b>Ref. No.</b>	94402
<b>description</b>	gas injector thread M12x1 WS 14 bore ø 1.40mm		

## gas nozzles M15x1



1

<b>Part No.</b>	100451	<b>Ref. No.</b>	94461
<b>description</b>	gas injector thread M15x1 bore ø 1.50mm WS 17		



1

<b>Part No.</b>	100453	<b>Ref. No.</b>	94462
<b>description</b>	gas injector thread M15x1 bore ø 2.00mm WS 17		



1

<b>Part No.</b>	100330	<b>Ref. No.</b>	94463
<b>description</b>	gas injector thread M15x1 bore ø 2.20mm WS 17		



1

<b>Part No.</b>	100456	<b>Ref. No.</b>	94464
<b>description</b>	gas injector thread M15x1 bore ø 2.50mm WS 17		



1

<b>Part No.</b>	100457	<b>Ref. No.</b>	94465
<b>description</b>	gas injector thread M15x1 bore ø 2.60mm WS 17		



1

<b>Part No.</b>	100698	<b>Ref. No.</b>	94466
<b>description</b>	gas injector thread M15x1 bore ø 3.00mm WS 17		



1

<b>Part No.</b>	100339	<b>Ref. No.</b>	94467
<b>description</b>	gas injector thread M15x1 bore ø 3.40mm WS 17		



## bypass nozzles

### bypass nozzles PEL22



1

<b>Part No.</b>	100281	<b>Ref. No.</b>	94451
<b>description</b>	bypass nozzle type PEL22 bore ø 0.4mm thread M6x0.5		



1

<b>Part No.</b>	100391	<b>Ref. No.</b>	94453
<b>description</b>	bypass nozzle type PEL22 bore ø 0.55mm thread M6x0.5		



1

<b>Part No.</b>	100390	<b>Ref. No.</b>	94452
<b>description</b>	bypass nozzle type PEL22 bore ø 0.5mm thread M6x0.5		



1

<b>Part No.</b>	100392	<b>Ref. No.</b>	94454
<b>description</b>	bypass nozzle type PEL22 bore ø 0.6mm thread M6x0.5		



1

<b>Part No.</b>	100407	<b>Ref. No.</b>	94455
<b>description</b>	bypass nozzle type PEL22 bore ø 1mm thread M6x0.5		

### bypass nozzles PEL23/24



1

<b>Part No.</b>	100459	<b>Ref. No.</b>	94472
<b>description</b>	bypass nozzle type PEL23/24 bore ø 0.65mm thread M8x0.5		

## internal nozzles

### EGA 24197/24362



1

<b>Part No.</b>	100492	<b>Ref. No.</b>	94471
<b>description</b>	internal nozzle bore ø 0.8mm type EGA/PEL22		



1

<b>Part No.</b>	100495	<b>Ref. No.</b>	94472
<b>description</b>	internal nozzle bore ø 1.05mm type EGA/PEL22		



1

<b>Part No.</b>	100344	<b>Ref. No.</b>	94473
<b>description</b>	internal nozzle bore ø 1.2mm type EGA/PEL22		



1

<b>Part No.</b>	100648	<b>Ref. No.</b>	94475
<b>description</b>	internal nozzle bore ø 1.35mm type EGA/PEL22		



1

<b>Part No.</b>	100647	<b>Ref. No.</b>	94474
<b>description</b>	internal nozzle bore ø 1.3mm type EGA/PEL22		



1

<b>Part No.</b>	100656	<b>Ref. No.</b>	94476
<b>description</b>	internal nozzle bore ø 1.6mm type EGA/PEL22		



1

<b>Part No.</b>	100658	<b>Ref. No.</b>	94477
<b>description</b>	internal nozzle bore ø 1.8mm type EGA/PEL22		

### internal nozzles for gas tap MADEC



1

<b>Part No.</b>	100421	<b>Ref. No.</b>	94401
<b>description</b>	internal nozzle MADEC bore ø 0.8mm		

## auxiliary gas parts

### screw connections

#### end caps



1

<b>Part No.</b>	101590	<b>Ref. No.</b>	94482
<b>description</b>	locking screw thread M10x1		

#### olives



1

<b>Part No.</b>	101273	<b>Ref. No.</b>	93107
<b>description</b>	olive for pipe ø 12mm L 9.5mm brass Qty 1 pcs suitable for universal		

**accessories for** 101273









<b>Part No.</b>	100944	<b>Ref. No.</b>	—
<b>description</b>	union nut thread M18x1.5 for pipe ø 12mm		

Table continues overleaf





accessories for	101273			
	Part No.	101276	Ref. No.	—
union screw thread 3/8" tube ø 12mm Qty 1 pcs				

1 				
Part No.	101281	Ref. No.	91606	
description olive for pipe ø 4mm L 8.7mm Qty 1 pcs suitable for CB 502/503				
accessories for	101281			
	Part No.	101283	Ref. No.	—
union screw thread M10x1 for pipe ø 4mm Qty 1 pcs				

1 				
Part No.	101284	Ref. No.	93105	
description olive for pipe ø 4mm Qty 1 pcs				
accessories for	101284			
	Part No.	101259	Ref. No.	—
union nut thread M8x1 for pipe ø 4mm				
	Part No.	101285	Ref. No.	26009
union screw thread M8x1 for pipe ø 4mm Qty 1 pcs JUNKERS				
	Part No.	101294	Ref. No.	—
union nut thread M10x1 for pipe ø 4mm WS 14 L 12mm Qty 1 pcs				

## union screws

1 				
Part No.	101285	Ref. No.	26009	
description union screw thread M8x1 for pipe ø 4mm Qty 1 pcs JUNKERS				
accessories for	101285			
	Part No.	101284	Ref. No.	93105
olive for pipe ø 4mm Qty 1 pcs				

## knobs



## universal knobs



1 			
Part No.	110236	Ref. No.	94231
description knob graduated t.max.°C ø 50mm shaft ø 6x4.6mm shaft flat upper black			

1 			
Part No.	110253	Ref. No.	94714
description knob switch zero mark t.max.°C ø 50mm shaft ø 6x4.6mm shaft flat upper black			

## producer-specific knobs

## HEIDEBRENNER

1 				
Part No.	110064	Ref. No.	93207	
description knob				
accessories for	110064			
	Part No.	110066	Ref. No.	—
knob screw				

1 				
Part No.	110065	Ref. No.	93208	
description knob				
accessories for	110065			
	Part No.	110067	Ref. No.	—
knob screw				

1

<b>Part No.</b>	111941	<b>Ref. No.</b>	93116
<b>description</b>	knob gas tap with ignition flame ø 60mm shaft ø 9x6mm shaft flat horizontal black		



1

<b>Part No.</b>	111939	<b>Ref. No.</b>	93117
<b>description</b>	knob gas tap without ignition flame ø 60mm shaft ø 9x6.5mm shaft flat horizontal black		









1

<b>Part No.</b>	110150	<b>Ref. No.</b>	93118
<b>description</b>	knob gas tap without ignition flame t.max.°C ø 50mm shaft ø 8x5.5mm shaft flat right white		



1

<b>Part No.</b>	112489	<b>Ref. No.</b>	N/A
<b>description</b>	knob universal ø 55.2mm black without adaptor/dial plate		
<b>accessories for</b>	112489		
	<b>Part No.</b>	110500	<b>Ref. No.</b> —
	knob dial plate gas tap without ignition flame EGA26400 t.max.°C ED ø 45mm silver		
	<b>Part No.</b>	110501	<b>Ref. No.</b> —
	knob dial plate gas tap with ignition flame EGA24197 t.max.°C ED ø 45mm silver		
	<b>Part No.</b>	110502	<b>Ref. No.</b> —
	knob dial plate gas tap with ignition flame EGA24197 t.max.°C ED ø 45mm silver		
	<b>Part No.</b>	110503	<b>Ref. No.</b> —
	knob dial plate gas tap with ignition flame EGA26440 t.max.°C ED ø 45mm silver		
	<b>Part No.</b>	110504	<b>Ref. No.</b> 94652
	knob dial plate gas tap PEL21/22/23 t.max.°C ED ø 45mm silver		
	<b>Part No.</b>	110505	<b>Ref. No.</b> —
	knob dial plate gas tap PEL21/22/23 t.max.°C ED ø 45mm red		
	<b>Part No.</b>	110506	<b>Ref. No.</b> —
	knob dial plate gas thermostat EGA 1-8 t.max.°C ED ø 45mm red		





















<b>accessories for</b>	112489		
	<b>Part No.</b>	110507	<b>Ref. No.</b> —
	knob dial plate switch 4-position t.max.°C ED ø 45mm silver		
	<b>Part No.</b>	110508	<b>Ref. No.</b> —
	knob dial plate switch 4-position t.max.°C ED ø 45mm silver		
	<b>Part No.</b>	110509	<b>Ref. No.</b> —
	knob dial plate switch 7-position t.max.°C ED ø 45mm silver		
	<b>Part No.</b>	110510	<b>Ref. No.</b> —
	knob dial plate switch 7-position t.max.°C ED ø 45mm silver		
	<b>Part No.</b>	110511	<b>Ref. No.</b> —
	knob dial plate switch 0-1-0-1 t.max.°C ED ø 45mm red		
	<b>Part No.</b>	110512	<b>Ref. No.</b> —
	knob dial plate oven TH/BH/TH+BH t.max.°C ED ø 45mm turn direction anti clockwise red		
	<b>Part No.</b>	110513	<b>Ref. No.</b> —
	knob dial plate oven ED ø 45mm red		
	<b>Part No.</b>	110514	<b>Ref. No.</b> —
	knob dial plate thermostat t.max. 110°C 30-110°C rotation 310° ED ø 45mm red		
	<b>Part No.</b>	110515	<b>Ref. No.</b> —
	knob dial plate thermostat t.max. 220°C 100-220°C rotation 310° ED ø 45mm silver		
	<b>Part No.</b>	110516	<b>Ref. No.</b> —
	knob dial plate thermostat t.max. 300°C 50-300°C ED ø 45mm red		
	<b>Part No.</b>	110517	<b>Ref. No.</b> —
	knob dial plate thermostat t.max. 110°C 30-110°C rotation 270° ED ø 45mm silver		
	<b>Part No.</b>	110518	<b>Ref. No.</b> —
	knob dial plate thermostat t.max. 180°C 100-180°C rotation 270° ED ø 45mm silver		
	<b>Part No.</b>	110519	<b>Ref. No.</b> —
	knob dial plate thermostat t.max. 250°C 50-250°C rotation 270° ED ø 45mm silver		
	<b>Part No.</b>	110520	<b>Ref. No.</b> —
	knob dial plate thermostat t.max. 300°C 50-300°C rotation 270° ED ø 45mm silver		
	<b>Part No.</b>	110521	<b>Ref. No.</b> —
	knob dial plate switch 4-position t.max.°C ED ø 45mm silver		
	<b>Part No.</b>	110522	<b>Ref. No.</b> —
	knob dial plate switch 7-position t.max.°C ED ø 45mm silver		
	<b>Part No.</b>	110523	<b>Ref. No.</b> —
	knob dial plate thermostat t.max. 110°C 30-110°C rotation 310° ED ø 45mm silver		
	<b>Part No.</b>	110524	<b>Ref. No.</b> —
	knob dial plate thermostat t.max. 300°C 50-300°C rotation 310° ED ø 45mm silver		
	<b>Part No.</b>	110658	<b>Ref. No.</b> —
	knob dial plate time 120min ED ø 45mm blue		
	<b>Part No.</b>	110663	<b>Ref. No.</b> —
	knob dial plate thermostat 1-10 rotation 310° ED ø 45mm blue		

Table continues overleaf



accessories for		112489		
Part No.	Ref. No.	Ref. No.	Ref. No.	—
	110739	—	—	—
knob dial plate switch 0-1-0-1 ED ø 45mm blue				
Part No.	110742	Ref. No.	Ref. No.	—
knob dial plate switch 4-position ED ø 45mm blue				
	110883	Ref. No.	Ref. No.	—
knob dial plate thermostat t.max. 300°C ED ø 45mm blue				
	110885	Ref. No.	Ref. No.	—
knob dial plate thermostat t.max. 110°C ED ø 45mm blue				
	110886	Ref. No.	Ref. No.	—
knob dial plate thermostat t.max. 180°C ED ø 45mm blue				
	111743	Ref. No.	Ref. No.	—
knob dial plate energy regulator 1-3 t.max.°C ED ø 45mm silver				
	111744	Ref. No.	Ref. No.	—
knob dial plate thermostat t.max. 85°C 30-85°C ED ø 45mm silver				
	111879	Ref. No.	Ref. No.	—
knob dial plate energy regulator 1-10 2-circuit t.max.°C ED ø 45mm silver				
	111880	Ref. No.	Ref. No.	—
knob dial plate switch 0-1-0-1 t.max.°C ED ø 45mm silver				
	111881	Ref. No.	Ref. No.	—
knob dial plate energy regulator 1-3 ED ø 45mm silver				
	111882	Ref. No.	Ref. No.	—
knob dial plate time 120min + permanent ON ED ø 45mm silver				
	112174	Ref. No.	Ref. No.	N/A
knob adapter shaft ø 10x8mm L 0mm				
	112175	Ref. No.	Ref. No.	—
knob adapter shaft ø 8x6.5mm L 0mm				
	112177	Ref. No.	Ref. No.	—
knob adapter shaft ø 8x7mm L 0mm				
	112178	Ref. No.	Ref. No.	N/A
knob adapter shaft ø 8x5mm L 0mm				
	112179	Ref. No.	Ref. No.	N/A
knob adapter shaft ø 9x6.5mm L 0mm				
	112269	Ref. No.	Ref. No.	93979
washer shaft ø 6x4.6mm ø 16mm H 1mm Qty 10 pcs				
	112270	Ref. No.	Ref. No.	—
washer shaft ø 8x5/8x6.5/8x7/7x7mm ø 16mm H 1mm Qty 10 pcs				
	112271	Ref. No.	Ref. No.	—
washer shaft ø 9x6.5/10x8/10x9/8x8mm ø 16mm H 1mm Qty 10 pcs				
	112304	Ref. No.	Ref. No.	—
knob adapter shaft ø 7x7mm L 0mm				



















accessories for		112489		
Part No.	Ref. No.	Ref. No.	Ref. No.	—
	112305	Ref. No.	Ref. No.	—
knob adapter shaft ø 8x8mm L 0mm				
	112311	Ref. No.	Ref. No.	N/A
knob adapter shaft ø 6x4.6mm L 0mm with spring				
	112312	Ref. No.	Ref. No.	—
knob adapter shaft ø 10x9mm L 0mm				
	112342	Ref. No.	Ref. No.	—
knob adapter shaft ø 8mm L 0mm with screw				
	112343	Ref. No.	Ref. No.	N/A
knob adapter shaft ø 10mm L 0mm with screw				
	112414	Ref. No.	Ref. No.	—
knob dial plate switch 0-1 t.max.°C ED ø 45mm silver				
	112416	Ref. No.	Ref. No.	—
knob dial plate switch 5-position t.max.°C ED ø 45mm silver				
	112420	Ref. No.	Ref. No.	—
knob dial plate thermostat t.max. 90°C 30-90°C rotation 270° ED ø 45mm silver				
	112421	Ref. No.	Ref. No.	—
knob dial plate thermostat t.max. 90°C 30-90°C rotation 310° ED ø 45mm silver				
	112423	Ref. No.	Ref. No.	—
knob dial plate thermostat t.max. 185°C 100-185°C rotation 270° ED ø 45mm silver				
	112424	Ref. No.	Ref. No.	—
knob dial plate thermostat t.max. 195°C 100-195°C rotation 270° ED ø 45mm silver				
	112425	Ref. No.	Ref. No.	—
knob dial plate thermostat t.max. 200°C 60-200°C rotation 270° ED ø 45mm silver				
	112426	Ref. No.	Ref. No.	—
knob dial plate thermostat t.max. 270°C 0-270°C rotation 250° ED ø 45mm silver				
	112427	Ref. No.	Ref. No.	—
knob dial plate thermostat t.max. 350°C 100-350°C rotation 270° ED ø 45mm silver				
	112428	Ref. No.	Ref. No.	—
knob dial plate thermostat t.max. 500°C 50-500°C rotation 270° ED ø 45mm silver				
	112429	Ref. No.	Ref. No.	—
knob dial plate thermostat t.max. 500°C 50-500°C rotation 310° ED ø 45mm silver				
	112430	Ref. No.	Ref. No.	—
knob dial plate energy regulator 1-3 t.max.°C energy regulator°C ED ø 45mm turn direction clockwise silver				
	112431	Ref. No.	Ref. No.	—
knob dial plate energy regulator 1-3 2-circuit t.max.°C ED ø 45mm silver				
	112432	Ref. No.	Ref. No.	—
knob dial plate gas tap with ignition flame COPRECI t.max.°C ED ø 45mm silver				

Table continues overleaf





accessories for		112489	
	Part No.	112433	Ref. No. —
	knob dial plate gas tap with ignition flame STN3R t.max.°C ED ø 45mm silver		
	Part No.	112434	Ref. No. N/A
	knob dial plate gas tap without ignition flame PEL20 t.max.°C ED ø 45mm silver		
	Part No.	112435	Ref. No. —
	knob dial plate gas tap without ignition flame SIRAL t.max.°C ED ø 45mm silver		
	Part No.	112436	Ref. No. —
	knob dial plate gas tap without ignition flame STN3R t.max.°C ED ø 45mm silver		
	Part No.	112437	Ref. No. —
	knob dial plate gas thermostat COPRECI 1-8 t.max.°C ED ø 45mm silver		
	Part No.	112438	Ref. No. —
	knob dial plate gas thermostat EGA 1-8 t.max.°C ED ø 45mm silver		
	Part No.	112439	Ref. No. —
	knob dial plate gas thermostat EUROSIT 1-8 t.max.°C ED ø 45mm silver		
	Part No.	112440	Ref. No. —
	knob dial plate gas thermostat PEL 1-8 t.max.°C ED ø 45mm silver		
	Part No.	112441	Ref. No. —
	knob dial plate gas thermostat SABAF 1-8 t.max.°C ED ø 45mm silver		
	Part No.	112442	Ref. No. —
	knob dial plate gas valves NOVASIT ED ø 45mm silver		
	Part No.	112443	Ref. No. —
	knob dial plate switch zero mark t.max.°C ED ø 45mm silver		
	Part No.	112444	Ref. No. —
	knob dial plate thermostat 1-10 t.max.°C rotation 270° ED ø 45mm silver		
	Part No.	112445	Ref. No. —
	knob dial plate thermostat 1-10 t.max.°C rotation 310° silver		
	Part No.	112446	Ref. No. —
	knob dial plate water tap cold t.max.°C ED ø 45mm silver		
	Part No.	112447	Ref. No. —
	knob dial plate water tap hot t.max.°C ED ø 45mm silver		
	Part No.	112450	Ref. No. —
	knob adapter shaft ø 8x6.5mm L 0mm		
	Part No.	112490	Ref. No. —
	knob dial plate gas tap with ignition flame EGA26440 t.max.°C EGA26440 ED ø 45mm silver		
	Part No.	112514	Ref. No. —
	knob adapter shaft ø 10x8mm L 6mm		
	Part No.	112515	Ref. No. —
	knob adapter shaft ø 8x6.5mm L 6mm		
	Part No.	112516	Ref. No. —
	knob adapter shaft ø 6x4.6mm L 6mm		

accessories for		112489	
	Part No.	112521	Ref. No. —
	knob dial plate energy regulator 1-3 t.max.°C turn direction anti clockwise ED ø 45mm silver		

1			
Part No.	111592	Ref. No.	94651
description	knob universal shaft ø 10mm		

1			
Part No.	112343	Ref. No.	N/A
description	knob adapter shaft ø 10mm L 0mm with screw		

1			
Part No.	112174	Ref. No.	N/A
description	knob adapter shaft ø 10x8mm L 0mm		

1			
Part No.	112311	Ref. No.	N/A
description	knob adapter shaft ø 6x4.6mm L 0mm with spring		

1			
Part No.	112178	Ref. No.	N/A
description	knob adapter shaft ø 8x5mm L 0mm		

1			
Part No.	112179	Ref. No.	N/A
description	knob adapter shaft ø 9x6.5mm L 0mm		



































<b>Part No.</b>	110504	<b>Ref. No.</b>	94652
<b>description</b>	knob dial plate gas tap PEL21/22/23 t.max.°C ED ø 45mm silver		



<b>Part No.</b>	112434	<b>Ref. No.</b>	N/A
<b>description</b>	knob dial plate gas tap without ignition flame PEL20 t.max.°C ED ø 45mm silver		



<b>Part No.</b>	112173 <sup>1</sup>	<b>Ref. No.</b>	N/A	
<b>description</b>	knob universal ø 62mm black without adaptor/dial plate			
<b>accessories for</b>	112173			
	<b>Part No.</b>	110530	<b>Ref. No.</b>	—
	knob dial plate silver thermostat t.max. 300°C 60-300°C rotation 270° ED ø 59mm ID ø 45.5mm			
	<b>Part No.</b>	110531	<b>Ref. No.</b>	—
	knob dial plate silver time 120min + permanent ON t.max.°C ED ø 59mm ID ø 45.5mm			
	<b>Part No.</b>	110532	<b>Ref. No.</b>	—
	knob dial plate red thermostat t.max. 300°C 0-300°C rotation 270° ED ø 59mm ID ø 45.5mm			
	<b>Part No.</b>	110533	<b>Ref. No.</b>	—
	knob dial plate red thermostat t.max. 100°C 0-100°C rotation 270° ED ø 59mm ID ø 45.5mm			
	<b>Part No.</b>	110534	<b>Ref. No.</b>	—
	knob dial plate silver time 120min + permanent ON t.max.°C ED ø 59mm ID ø 45.5mm			
	<b>Part No.</b>	110535	<b>Ref. No.</b>	—
	knob dial plate red thermostat t.max. 250°C 50-250°C rotation 270° ED ø 59mm ID ø 45.5mm			
	<b>Part No.</b>	110536	<b>Ref. No.</b>	—
	knob dial plate silver thermostat t.max. 195°C 100-195°C rotation 270° ED ø 59mm ID ø 45.5mm			
	<b>Part No.</b>	110537	<b>Ref. No.</b>	—
	knob dial plate silver switch zero mark t.max.°C ED ø 59mm ID ø 45.5mm			
	<b>Part No.</b>	110538	<b>Ref. No.</b>	—
	knob dial plate red gas tap with ignition flame EGA24197 t.max.°C ED ø 59mm ID ø 45.5mm			
	<b>Part No.</b>	110539	<b>Ref. No.</b>	—
	knob dial plate silver switch 2-0-1 t.max.°C 1-2°C ED ø 59mm ID ø 45.5mm			
	<b>Part No.</b>	110540	<b>Ref. No.</b>	94222
	knob dial plate silver thermostat 1-10 t.max.°C 1-10°C rotation 270° ED ø 59mm ID ø 45.5mm			

<b>accessories for</b>	112173			
	<b>Part No.</b>	110541	<b>Ref. No.</b>	—
	knob dial plate silver gas tap without ignition flame EGA26400 t.max.°C ED ø 59mm ID ø 45.5mm			
	<b>Part No.</b>	110542	<b>Ref. No.</b>	N/A
	knob dial plate silver switch 0-1-0-1 t.max.°C ED ø 59mm ID ø 45.5mm			
	<b>Part No.</b>	110543	<b>Ref. No.</b>	—
	knob dial plate silver gas thermostat EGA 1-8 t.max.°C ED ø 59mm ID ø 45.5mm			
	<b>Part No.</b>	110544	<b>Ref. No.</b>	—
	knob dial plate silver 0-FRITTIEREN-0-SCHMELZEN t.max.°C ED ø 59mm ID ø 45.5mm			
	<b>Part No.</b>	110545	<b>Ref. No.</b>	—
	knob dial plate silver thermostat t.max. 110°C 30-110°C rotation 310° ED ø 59mm ID ø 45.5mm			
	<b>Part No.</b>	110546	<b>Ref. No.</b>	—
	knob dial plate red thermostat t.max. 110°C 30-110°C rotation 270° ED ø 59mm ID ø 45.5mm			
	<b>Part No.</b>	110547	<b>Ref. No.</b>	—
	knob dial plate red gas thermostat EGA 1-8 t.max.°C ED ø 59mm ID ø 45.5mm			
	<b>Part No.</b>	110548	<b>Ref. No.</b>	—
	knob dial plate red switch 1-2-1-2 t.max.°C ED ø 59mm ID ø 45.5mm			
	<b>Part No.</b>	110549	<b>Ref. No.</b>	N/A
	knob dial plate red thermostat t.max. 300°C 50-300°C rotation 270° ED ø 59mm ID ø 45.5mm			
	<b>Part No.</b>	110550	<b>Ref. No.</b>	—
	knob dial plate silver gas tap with ignition flame EGA26440 t.max.°C ED ø 59mm ID ø 45.5mm			
	<b>Part No.</b>	110551	<b>Ref. No.</b>	N/A
	knob dial plate silver energy regulator 1-3 t.max.°C turn direction clockwise ED ø 59mm ID ø 45.5mm			
	<b>Part No.</b>	110552	<b>Ref. No.</b>	N/A
	knob dial plate silver switch 7-position t.max.°C ED ø 59mm ID ø 45.5mm			
	<b>Part No.</b>	110553	<b>Ref. No.</b>	—
	knob dial plate silver switch 4-position t.max.°C ED ø 59mm ID ø 45.5mm			
	<b>Part No.</b>	110554	<b>Ref. No.</b>	—
	knob dial plate silver thermostat t.max. 300°C 0-300°C rotation 270° ED ø 59mm ID ø 45.5mm			
	<b>Part No.</b>	110555	<b>Ref. No.</b>	—
	knob dial plate silver time 120min + permanent ON t.max.°C ED ø 59mm ID ø 45.5mm			
	<b>Part No.</b>	110556	<b>Ref. No.</b>	—
	knob dial plate silver thermostat t.max. 100°C 0-100°C rotation 270° ED ø 59mm ID ø 45.5mm			
	<b>Part No.</b>	110557	<b>Ref. No.</b>	—
	knob dial plate silver thermostat t.max. 270°C 0-270°C rotation 250° ED ø 59mm ID ø 45.5mm			
	<b>Part No.</b>	110558	<b>Ref. No.</b>	—
	knob dial plate silver gas tap PEL21/22/23 t.max.°C ED ø 59mm ID ø 45.5mm PEL			
	<b>Part No.</b>	111553	<b>Ref. No.</b>	N/A
	knob dial plate silver switch 5-position t.max.°C ED ø 59mm ID ø 45.5mm			
	<b>Part No.</b>	111560	<b>Ref. No.</b>	—
	knob dial plate silver energy regulator 1-3 2-circuit t.max.°C ED ø 59mm ID ø 45.5mm			

<sup>1</sup>matching adapter and symbol must be ordered separately

Table continues overleaf



accessories for 112173		Part No.	Ref. No.	
	knob dial plate silver thermostat t.max. 195°C 100-195°C rotation 270° ED ø 59mm ID ø 45.5mm	111563	—	
	knob dial plate silver thermostat t.max. 185°C 100-185°C rotation 270° ED ø 59mm ID ø 45.5mm	111564	—	
	knob dial plate silver thermostat t.max. 110°C 60-110°C rotation 180° ED ø 59mm ID ø 45.5mm	111565	—	
	knob dial plate silver switch 2-0-1 t.max.°C ED ø 59mm ID ø 45.5mm	111566	—	
	knob dial plate black manual/automatic t.max.°C	111567	—	
	knob dial plate red gas thermostat ROBERTSHAW t.max.°C ED ø 59mm ID ø 45.5mm	111568	—	
	knob dial plate silver switch 1-2-1-2 t.max.°C ED ø 59mm ID ø 45.5mm	111711	—	
	knob dial plate silver thermostat t.max. 110°C 30-110°C rotation 270° ED ø 59mm ID ø 45.5mm	111878	—	
	knob dial plate silver oven t.max.°C ED ø 59mm ID ø 45.5mm	111946	—	
	knob dial plate silver thermostat t.max. 250°C 50-250°C rotation 270° ED ø 59mm ID ø 45.5mm	111947	—	
	knob dial plate silver thermostat t.max. 300°C 50-300°C rotation 310° ED ø 59mm ID ø 45.5mm	111961	—	
	knob adapter shaft ø 10x8mm L 0mm	112174	N/A	
	knob adapter shaft ø 8x6.5mm L 0mm	112175	—	
	knob adapter shaft ø 8x7mm L 0mm	112177	—	
	knob adapter shaft ø 8x5mm L 0mm	112178	N/A	
	knob adapter shaft ø 9x6.5mm L 0mm	112179	N/A	
	knob dial plate red switch 0-1-0-1 t.max.°C ED ø 59mm ID ø 45.5mm	112252	—	
	knob dial plate red switch 4-position t.max.°C ED ø 59mm ID ø 45.5mm	112254	—	
	knob dial plate red switch 7-position t.max.°C ED ø 59mm ID ø 45.5mm	112256	—	
	knob dial plate red thermostat t.max. 90°C 30-90°C rotation 270° ED ø 59mm ID ø 45.5mm	112258	—	

accessories for 112173		Part No.	Ref. No.	
	knob dial plate silver thermostat t.max. 90°C 30-90°C rotation 270° ED ø 59mm ID ø 45.5mm	112259	—	
	knob dial plate red thermostat t.max. 90°C 30-90°C rotation 310° ED ø 59mm ID ø 45.5mm	112260	—	
	knob dial plate silver thermostat t.max. 90°C 30-90°C rotation 310° ED ø 59mm ID ø 45.5mm	112261	—	
	knob dial plate red thermostat t.max. 110°C 30-110°C rotation 310° ED ø 59mm ID ø 45.5mm	112264	—	
	knob dial plate red thermostat t.max. 180°C 100-180°C rotation 270° ED ø 59mm ID ø 45.5mm	112266	—	
	knob dial plate silver thermostat t.max. 180°C 100-180°C rotation 270° ED ø 59mm ID ø 45.5mm	112267	N/A	
	knob dial plate red thermostat t.max. 195°C 100-195°C rotation 270° ED ø 59mm ID ø 45.5mm	112268	—	
	washer shaft ø 6x4.6mm ø 16mm H 1mm Qty 10 pcs	112269	93979	
	washer shaft ø 8x5/8x6.5/8x7/7x7mm ø 16mm H 1mm Qty 10 pcs	112270	—	
	washer shaft ø 9x6.5/10x8/10x9/8x8mm ø 16mm H 1mm Qty 10 pcs	112271	—	
	knob dial plate red thermostat t.max. 300°C 50-300°C rotation 310° ED ø 59mm ID ø 45.5mm	112272	—	
	knob dial plate red thermostat t.max. 320°C 50-320°C rotation 270° ED ø 59mm ID ø 45.5mm	112276	—	
	knob dial plate silver thermostat t.max. 320°C 50-320°C rotation 270° ED ø 59mm ID ø 45.5mm	112277	—	
	knob dial plate red energy regulator 1-3 t.max.°C turn direction clockwise ED ø 59mm ID ø 45.5mm	112278	—	
	knob dial plate silver gas tap with ignition flame EGA24197 t.max.°C ED ø 59mm ID ø 45.5mm	112281	—	
	knob dial plate red gas tap PEL21/22/23 t.max.°C ED ø 59mm ID ø 45.5mm	112282	—	
	knob dial plate red gas tap without ignition flame PEL20 t.max.°C ED ø 59mm ID ø 45.5mm	112284	—	
	knob dial plate silver gas tap without ignition flame PEL20 t.max.°C ED ø 59mm ID ø 45.5mm	112285	—	
	knob dial plate red gas thermostat PEL 1-8 t.max.°C ED ø 59mm ID ø 45.5mm	112288	—	
	knob dial plate silver gas thermostat PEL 1-8 t.max.°C ED ø 59mm ID ø 45.5mm	112289	—	

Table continues overleaf



accessories for		112173		
Part No.	Ref. No.	Ref. No.	Ref. No.	Ref. No.
	112290	—	—	—
knob dial plate red switch zero mark t.max.°C ED ø 59mm ID ø 45.5mm				
	112292	—	—	—
knob dial plate red thermostat 1-10 t.max.°C rotation 270° ED ø 59mm ID ø 45.5mm				
	112294	—	—	—
knob dial plate red thermostat 1-10 t.max.°C rotation 310° ED ø 59mm ID ø 45.5mm				
	112295	—	—	—
knob dial plate silver thermostat 1-10 t.max.°C rotation 310° ED ø 59mm ID ø 45.5mm				
	112298	93972	—	—
knob dial plate red switch 5-position t.max.°C ED ø 59mm ID ø 45.5mm				
	112299	—	—	—
knob dial plate red thermostat t.max. 185°C 100-185°C rotation 270° ED ø 59mm ID ø 45.5mm				
	112300	—	—	—
knob dial plate red thermostat t.max. 300°C 60-300°C rotation 270° ED ø 59mm ID ø 45.5mm				
	112301	—	—	—
knob dial plate red energy regulator 1-3 2-circuit t.max.°C ED ø 59mm ID ø 45.5mm				
	112304	—	—	—
knob adapter shaft ø 7x7mm L 0mm				
	112305	—	—	—
knob adapter shaft ø 8x8mm L 0mm				
	112308	—	—	—
knob dial plate red gas tap with ignition flame STN3R t.max.°C ED ø 59mm ID ø 45.5mm				
	112309	—	—	—
knob dial plate silver gas tap with ignition flame STN3R t.max.°C ED ø 59mm ID ø 45.5mm				
	112311	N/A	—	—
knob adapter shaft ø 6x4.6mm L 0mm with spring				
	112312	—	—	—
knob adapter shaft ø 10x9mm L 0mm				
	112332	—	—	—
knob dial plate red gas thermostat EUROSIT 1-8 t.max.°C ED ø 59mm ID ø 45.5mm				
	112333	—	—	—
knob dial plate silver gas thermostat EUROSIT 1-8 t.max.°C ED ø 59mm ID ø 45.5mm				
	112334	—	—	—
knob dial plate red gas thermostat SABAF 1-8 t.max.°C ED ø 59mm ID ø 45.5mm				
	112335	—	—	—
knob dial plate silver gas thermostat SABAF 1-8 t.max.°C ED ø 59mm ID ø 45.5mm				
	112336	—	—	—
knob dial plate red oven TH/BH/TH+BH t.max.°C turn direction anti clockwise ED ø 59mm ID ø 45.5mm				
	112337	—	—	—
knob dial plate silver oven TH/BH/TH+BH t.max.°C turn direction anti clockwise ED ø 59mm ID ø 45.5mm				

accessories for		112173		
Part No.	Ref. No.	Ref. No.	Ref. No.	Ref. No.
	112338	—	—	—
knob dial plate red oven TH/BH/TH+BH t.max.°C turn direction clockwise ED ø 59mm ID ø 45.5mm				
	112339	—	—	—
knob dial plate silver oven TH/BH/TH+BH t.max.°C turn direction clockwise ED ø 59mm ID ø 45.5mm				
	112342	—	—	—
knob adapter shaft ø 8mm L 0mm with screw				
	112343	N/A	—	—
knob adapter shaft ø 10mm L 0mm with screw				
	112344	—	—	—
knob dial plate red switch 0-1 t.max.°C ED ø 59mm ID ø 45.5mm				
	112345	—	—	—
knob dial plate silver switch 0-1 t.max.°C ED ø 59mm ID ø 45.5mm				
	112348	—	—	—
knob dial plate red switch 0-1-2 t.max.°C ED ø 59mm ID ø 45.5mm				
	112349	—	—	—
knob dial plate silver switch 0-1-2 t.max.°C ED ø 59mm ID ø 45.5mm				
	112352	—	—	—
knob dial plate red gas tap with ignition flame COPRECI t.max.°C ED ø 59mm ID ø 45.5mm				
	112353	—	—	—
knob dial plate silver gas tap with ignition flame COPRECI t.max.°C ED ø 59mm ID ø 45.5mm				
	112360	—	—	—
knob dial plate red gas thermostat COPRECI 1-8 t.max.°C ED ø 59mm ID ø 45.5mm				
	112361	—	—	—
knob dial plate silver gas thermostat COPRECI 1-8 t.max.°C ED ø 59mm ID ø 45.5mm				
	112365	—	—	—
knob dial plate silver gas valves NOVASIT t.max.°C ED ø 59mm ID ø 45.5mm				
	112369	—	—	—
knob dial plate silver water tap cold t.max.°C ED ø 59mm ID ø 45.5mm				
	112377	—	—	—
knob dial plate silver oven TH/BH/TH+BH t.max.°C turn direction anti clockwise ED ø 59mm ID ø 45.5mm				
	112382	—	—	—
knob dial plate red gas tap with ignition flame EGA26440 t.max.°C ED ø 59mm ID ø 45.5mm				
	112384	—	—	—
knob dial plate silver thermostat t.max. 150°C 40-150°C rotation 270° ED ø 59mm ID ø 45.5mm				
	112387	—	—	—
knob dial plate universal red				
	112388	—	—	—
knob dial plate universal silver				

Table continues overleaf





accessories for		112173	
Part No.	Ref. No.	Part No.	Ref. No.
	112391	Ref. No.	—
knob dial plate silver thermostat t.max. 85°C 30-85°C rotation 270° ED ø 59mm ID ø 45.5mm			
	112394	Ref. No.	—
knob dial plate red thermostat t.max. 200°C 60-200°C rotation 270° ED ø 59mm ID ø 45.5mm			
	112395	Ref. No.	—
knob dial plate silver thermostat t.max. 200°C 60-200°C rotation 270° ED ø 59mm ID ø 45.5mm			
	112398	Ref. No.	—
knob dial plate red thermostat t.max. 220°C 100-220°C rotation 310° ED ø 59mm ID ø 45.5mm			
	112399	Ref. No.	—
knob dial plate silver thermostat t.max. 220°C 100-220°C rotation 310° ED ø 59mm ID ø 45.5mm			
	112402	Ref. No.	—
knob dial plate red thermostat t.max. 350°C 100-350°C rotation 310° ED ø 59mm ID ø 45.5mm			
	112403	Ref. No.	—
knob dial plate silver thermostat t.max. 350°C 100-350°C rotation 310° ED ø 59mm ID ø 45.5mm			
	112406	Ref. No.	—
knob dial plate red thermostat t.max. 500°C 50-500°C rotation 270° ED ø 59mm ID ø 45.5mm			
	112407	Ref. No.	—
knob dial plate silver thermostat t.max. 500°C 50-500°C rotation 270° ED ø 59mm ID ø 45.5mm			
	112411	Ref. No.	—
knob dial plate silver thermostat t.max. 500°C 50-500°C rotation 310° ED ø 59mm ID ø 45.5mm			
	112448	Ref. No.	—
knob dial plate silver thermostat t.max. 100°C 40-100°C rotation 270° ED ø 59mm ID ø 45.5mm			
	112450	Ref. No.	—
knob adapter shaft ø 8x6.5mm L 0mm			
	112457	Ref. No.	—
knob dial plate black/yellow energy regulator 1-circuit t.max.°C turn direction clockwise ED ø 59mm ID ø 45.5mm			
	112461	Ref. No.	—
knob dial plate silver thermostat t.max. 190°C 120-190°C rotation 270° ED ø 59mm ID ø 45.5mm			
	112514	Ref. No.	—
knob adapter shaft ø 10x8mm L 6mm			
	112515	Ref. No.	—
knob adapter shaft ø 8x6.5mm L 6mm			
	112516	Ref. No.	—
knob adapter shaft ø 6x4.6mm L 6mm			
	112522	Ref. No.	—
knob dial plate silver energy regulator 1-3 t.max.°C turn direction anti clockwise ED ø 59mm ID ø 45.5mm			
	112601	Ref. No.	—
knob dial plate silver gas thermostat MERTIK 1-8 t.max.°C ED ø 59mm ID ø 45.5mm			
	112602	Ref. No.	—
knob dial plate red gas thermostat MERTIK 1-8 t.max.°C ED ø 59mm ID ø 45.5mm			





















accessories for		112173	
Part No.	Ref. No.	Part No.	Ref. No.
	112651	Ref. No.	—
knob dial plate universal black			

accessories for		112173	
Part No.	Ref. No.	Part No.	Ref. No.
	112568 <sup>1</sup>	Ref. No.	94651-001
knob universal ø 62mm silver-coloured without adaptor/dial plate zamak			
accessories for		112568	
	110530	Ref. No.	—
knob dial plate silver thermostat t.max. 300°C 60-300°C rotation 270° ED ø 59mm ID ø 45.5mm			
	110531	Ref. No.	—
knob dial plate silver time 120min + permanent ON t.max.°C ED ø 59mm ID ø 45.5mm			
	110532	Ref. No.	—
knob dial plate red thermostat t.max. 300°C 0-300°C rotation 270° ED ø 59mm ID ø 45.5mm			
	110533	Ref. No.	—
knob dial plate red thermostat t.max. 100°C 0-100°C rotation 270° ED ø 59mm ID ø 45.5mm			
	110534	Ref. No.	—
knob dial plate silver time 120min + permanent ON t.max.°C ED ø 59mm ID ø 45.5mm			
	110535	Ref. No.	—
knob dial plate red thermostat t.max. 250°C 50-250°C rotation 270° ED ø 59mm ID ø 45.5mm			
	110536	Ref. No.	—
knob dial plate silver thermostat t.max. 195°C 100-195°C rotation 270° ED ø 59mm ID ø 45.5mm			
	110537	Ref. No.	—
knob dial plate silver switch zero mark t.max.°C ED ø 59mm ID ø 45.5mm			
	110538	Ref. No.	—
knob dial plate red gas tap with ignition flame EGA24197 t.max.°C ED ø 59mm ID ø 45.5mm			
	110539	Ref. No.	—
knob dial plate silver switch 2-0-1 t.max.°C 1-2°C ED ø 59mm ID ø 45.5mm			
	110540	Ref. No.	94222
knob dial plate silver thermostat 1-10 t.max.°C 1-10°C rotation 270° ED ø 59mm ID ø 45.5mm			
	110541	Ref. No.	—
knob dial plate silver gas tap without ignition flame EGA26400 t.max.°C ED ø 59mm ID ø 45.5mm			
	110542	Ref. No.	N/A
knob dial plate silver switch 0-1-0-1 t.max.°C ED ø 59mm ID ø 45.5mm			
	110543	Ref. No.	—
knob dial plate silver gas thermostat EGA 1-8 t.max.°C ED ø 59mm ID ø 45.5mm			
	110544	Ref. No.	—
knob dial plate silver 0-FRITTIEREN-0-SCHMELZEN t.max.°C ED ø 59mm ID ø 45.5mm			

<sup>1</sup>matching adapter and symbol must be ordered separately  
Table continues overleaf





accessories for		112568		
	Part No.	Ref. No.		
	110545	—	knob dial plate silver thermostat t.max. 110°C 30-110°C rotation 310° ED ø 59mm ID ø 45.5mm	
	110546	—	knob dial plate red thermostat t.max. 110°C 30-110°C rotation 270° ED ø 59mm ID ø 45.5mm	
	110547	—	knob dial plate red gas thermostat EGA 1-8 t.max. °C°C ED ø 59mm ID ø 45.5mm	
	110548	—	knob dial plate red switch 1-2-1-2 t.max. °C°C ED ø 59mm ID ø 45.5mm	
	110549	N/A	knob dial plate red thermostat t.max. 300°C 50-300°C rotation 270° ED ø 59mm ID ø 45.5mm	
	110550	—	knob dial plate silver gas tap with ignition flame EGA26440 t.max. °C°C ED ø 59mm ID ø 45.5mm	
	110551	N/A	knob dial plate silver energy regulator 1-3 t.max. °C°C turn direction clockwise ED ø 59mm ID ø 45.5mm	
	110552	N/A	knob dial plate silver switch 7-position t.max. °C°C ED ø 59mm ID ø 45.5mm	
	110553	—	knob dial plate silver switch 4-position t.max. °C°C ED ø 59mm ID ø 45.5mm	
	110554	—	knob dial plate silver thermostat t.max. 300°C 0-300°C rotation 270° ED ø 59mm ID ø 45.5mm	
	110555	—	knob dial plate silver time 120min + permanent ON t.max. °C°C ED ø 59mm ID ø 45.5mm	
	110556	—	knob dial plate silver thermostat t.max. 100°C 0-100°C rotation 270° ED ø 59mm ID ø 45.5mm	
	110557	—	knob dial plate silver thermostat t.max. 270°C 0-270°C rotation 250° ED ø 59mm ID ø 45.5mm	
	110558	—	knob dial plate silver gas tap PEL21/22/23 t.max. °C°C ED ø 59mm ID ø 45.5mm PEL	
	111553	N/A	knob dial plate silver switch 5-position t.max. °C°C ED ø 59mm ID ø 45.5mm	
	111560	—	knob dial plate silver energy regulator 1-3 2-circuit t.max. °C°C ED ø 59mm ID ø 45.5mm	
	111563	—	knob dial plate silver thermostat t.max. 195°C 100-195°C rotation 270° ED ø 59mm ID ø 45.5mm	
	111564	—	knob dial plate silver thermostat t.max. 185°C 100-185°C rotation 270° ED ø 59mm ID ø 45.5mm	
	111565	—	knob dial plate silver thermostat t.max. 110°C 60-110°C rotation 180° ED ø 59mm ID ø 45.5mm	
	111566	—	knob dial plate silver switch 2-0-1 t.max. °C°C ED ø 59mm ID ø 45.5mm	











accessories for		112568		
	Part No.	Ref. No.		
	111567	—	knob dial plate black manual/automatic t.max. °C°C	
	111568	—	knob dial plate red gas thermostat ROBERTSHAW t.max. °C°C ED ø 59mm ID ø 45.5mm	
	111711	—	knob dial plate silver switch 1-2-1-2 t.max. °C°C ED ø 59mm ID ø 45.5mm	
	111878	—	knob dial plate silver thermostat t.max. 110°C 30-110°C rotation 270° ED ø 59mm ID ø 45.5mm	
	111946	—	knob dial plate silver oven t.max. °C°C ED ø 59mm ID ø 45.5mm	
	111947	—	knob dial plate silver thermostat t.max. 250°C 50-250°C rotation 270° ED ø 59mm ID ø 45.5mm	
	111961	—	knob dial plate silver thermostat t.max. 300°C 50-300°C rotation 310° ED ø 59mm ID ø 45.5mm	
	112174	N/A	knob adapter shaft ø 10x8mm L 0mm	
	112175	—	knob adapter shaft ø 8x6.5mm L 0mm	
	112177	—	knob adapter shaft ø 8x7mm L 0mm	
	112178	N/A	knob adapter shaft ø 8x5mm L 0mm	
	112179	N/A	knob adapter shaft ø 9x6.5mm L 0mm	
	112252	—	knob dial plate red switch 0-1-0-1 t.max. °C ED ø 59mm ID ø 45.5mm	
	112254	—	knob dial plate red switch 4-position t.max. °C ED ø 59mm ID ø 45.5mm	
	112256	—	knob dial plate red switch 7-position t.max. °C ED ø 59mm ID ø 45.5mm	
	112258	—	knob dial plate red thermostat t.max. 90°C 30-90°C rotation 270° ED ø 59mm ID ø 45.5mm	
	112259	—	knob dial plate silver thermostat t.max. 90°C 30-90°C rotation 270° ED ø 59mm ID ø 45.5mm	
	112260	—	knob dial plate red thermostat t.max. 90°C 30-90°C rotation 310° ED ø 59mm ID ø 45.5mm	
	112261	—	knob dial plate silver thermostat t.max. 90°C 30-90°C rotation 310° ED ø 59mm ID ø 45.5mm	
	112264	—	knob dial plate red thermostat t.max. 110°C 30-110°C rotation 310° ED ø 59mm ID ø 45.5mm	

Table continues overleaf



















accessories for 112568		Part No.	Ref. No.	
	knob dial plate red thermostat t.max. 180°C 100-180°C rotation 270° ED ø 59mm ID ø 45.5mm	112266	—	
	knob dial plate silver thermostat t.max. 180°C 100-180°C rotation 270° ED ø 59mm ID ø 45.5mm	112267	N/A	
	knob dial plate red thermostat t.max. 195°C 100-195°C rotation 270° ED ø 59mm ID ø 45.5mm	112268	—	
	washer shaft ø 6x4.6mm ø 16mm H 1mm Qty 10 pcs	112269	93979	
	washer shaft ø 8x5/8x6.5/8x7/7x7mm ø 16mm H 1mm Qty 10 pcs	112270	—	
	washer shaft ø 9x6.5/10x8/10x9/8x8mm ø 16mm H 1mm Qty 10 pcs	112271	—	
	knob dial plate red thermostat t.max. 300°C 50-300°C rotation 310° ED ø 59mm ID ø 45.5mm	112272	—	
	knob dial plate red thermostat t.max. 320°C 50-320°C rotation 270° ED ø 59mm ID ø 45.5mm	112276	—	
	knob dial plate silver thermostat t.max. 320°C 50-320°C rotation 270° ED ø 59mm ID ø 45.5mm	112277	—	
	knob dial plate red energy regulator 1-3 t.max.°C turn direction clockwise ED ø 59mm ID ø 45.5mm	112278	—	
	knob dial plate silver gas tap with ignition flame EGA24197 t.max.°C ED ø 59mm ID ø 45.5mm	112281	—	
	knob dial plate red gas tap PEL21/22/23 t.max.°C ED ø 59mm ID ø 45.5mm	112282	—	
	knob dial plate red gas tap without ignition flame PEL20 t.max.°C ED ø 59mm ID ø 45.5mm	112284	—	
	knob dial plate silver gas tap without ignition flame PEL20 t.max.°C ED ø 59mm ID ø 45.5mm	112285	—	
	knob dial plate red gas thermostat PEL 1-8 t.max.°C ED ø 59mm ID ø 45.5mm	112288	—	
	knob dial plate silver gas thermostat PEL 1-8 t.max.°C ED ø 59mm ID ø 45.5mm	112289	—	
	knob dial plate red switch zero mark t.max.°C ED ø 59mm ID ø 45.5mm	112290	—	
	knob dial plate red thermostat 1-10 t.max.°C rotation 270° ED ø 59mm ID ø 45.5mm	112292	—	
	knob dial plate red thermostat 1-10 t.max.°C rotation 310° ED ø 59mm ID ø 45.5mm	112294	—	
	knob dial plate silver thermostat 1-10 t.max.°C rotation 310° ED ø 59mm ID ø 45.5mm	112295	—	

accessories for 112568		Part No.	Ref. No.	
	knob dial plate red switch 5-position t.max.°C ED ø 59mm ID ø 45.5mm	112298	93972	
	knob dial plate red thermostat t.max. 185°C 100-185°C rotation 270° ED ø 59mm ID ø 45.5mm	112299	—	
	knob dial plate red thermostat t.max. 300°C 60-300°C rotation 270° ED ø 59mm ID ø 45.5mm	112300	—	
	knob dial plate red energy regulator 1-3 2-circuit t.max.°C ED ø 59mm ID ø 45.5mm	112301	—	
	knob adapter shaft ø 7x7mm L 0mm	112304	—	
	knob adapter shaft ø 8x8mm L 0mm	112305	—	
	knob dial plate red gas tap with ignition flame STN3R t.max.°C ED ø 59mm ID ø 45.5mm	112308	—	
	knob dial plate silver gas tap with ignition flame STN3R t.max.°C ED ø 59mm ID ø 45.5mm	112309	—	
	knob adapter shaft ø 6x4.6mm L 0mm with spring	112311	N/A	
	knob adapter shaft ø 10x9mm L 0mm	112312	—	
	knob dial plate red gas thermostat EUROSIT 1-8 t.max.°C ED ø 59mm ID ø 45.5mm	112332	—	
	knob dial plate silver gas thermostat EUROSIT 1-8 t.max.°C ED ø 59mm ID ø 45.5mm	112333	—	
	knob dial plate red gas thermostat SABAF 1-8 t.max.°C ED ø 59mm ID ø 45.5mm	112334	—	
	knob dial plate silver gas thermostat SABAF 1-8 t.max.°C ED ø 59mm ID ø 45.5mm	112335	—	
	knob dial plate red oven TH/BH/TH+BH t.max.°C turn direction anti clockwise ED ø 59mm ID ø 45.5mm	112336	—	
	knob dial plate silver oven TH/BH/TH+BH t.max.°C turn direction anti clockwise ED ø 59mm ID ø 45.5mm	112337	—	
	knob dial plate red oven TH/BH/TH+BH t.max.°C turn direction clockwise ED ø 59mm ID ø 45.5mm	112338	—	
	knob dial plate silver oven TH/BH/TH+BH t.max.°C turn direction clockwise ED ø 59mm ID ø 45.5mm	112339	—	
	knob adapter shaft ø 8mm L 0mm with screw	112342	—	

Table continues overleaf





accessories for		112568		
Part No.	Ref. No.	Ref. No.	Ref. No.	N/A
	112343			
knob adapter shaft ø 10mm L 0mm with screw				
	112344			—
knob dial plate red switch 0-1 t.max.°C ED ø 59mm ID ø 45.5mm				
	112345			—
knob dial plate silver switch 0-1 t.max.°C ED ø 59mm ID ø 45.5mm				
	112348			—
knob dial plate red switch 0-1-2 t.max.°C ED ø 59mm ID ø 45.5mm				
	112349			—
knob dial plate silver switch 0-1-2 t.max.°C ED ø 59mm ID ø 45.5mm				
	112352			—
knob dial plate red gas tap with ignition flame COPRECI t.max.°C ED ø 59mm ID ø 45.5mm				
	112353			—
knob dial plate silver gas tap with ignition flame COPRECI t.max.°C ED ø 59mm ID ø 45.5mm				
	112360			—
knob dial plate red gas thermostat COPRECI 1-8 t.max.°C ED ø 59mm ID ø 45.5mm				
	112361			—
knob dial plate silver gas thermostat COPRECI 1-8 t.max.°C ED ø 59mm ID ø 45.5mm				
	112365			—
knob dial plate silver gas valves NOVASIT t.max.°C ED ø 59mm ID ø 45.5mm				
	112369			—
knob dial plate silver water tap cold t.max.°C ED ø 59mm ID ø 45.5mm				
	112377			—
knob dial plate silver oven TH/BH/TH+BH t.max.°C turn direction anti clockwise ED ø 59mm ID ø 45.5mm				
	112382			—
knob dial plate red gas tap with ignition flame EGA26440 t.max.°C ED ø 59mm ID ø 45.5mm				
	112384			—
knob dial plate silver thermostat t.max. 150°C 40-150°C rotation 270° ED ø 59mm ID ø 45.5mm				
	112387			—
knob dial plate universal red				
	112388			—
knob dial plate universal silver				
	112391			—
knob dial plate silver thermostat t.max. 85°C 30-85°C rotation 270° ED ø 59mm ID ø 45.5mm				
	112394			—
knob dial plate red thermostat t.max. 200°C 60-200°C rotation 270° ED ø 59mm ID ø 45.5mm				
	112395			—
knob dial plate silver thermostat t.max. 200°C 60-200°C rotation 270° ED ø 59mm ID ø 45.5mm				
	112398			—
knob dial plate red thermostat t.max. 220°C 100-220°C rotation 310° ED ø 59mm ID ø 45.5mm				

accessories for		112568		
Part No.	Ref. No.	Ref. No.	Ref. No.	—
	112399			
knob dial plate silver thermostat t.max. 220°C 100-220°C rotation 310° ED ø 59mm ID ø 45.5mm				
	112402			—
knob dial plate red thermostat t.max. 350°C 100-350°C rotation 310° ED ø 59mm ID ø 45.5mm				
	112403			—
knob dial plate silver thermostat t.max. 350°C 100-350°C rotation 310° ED ø 59mm ID ø 45.5mm				
	112406			—
knob dial plate red thermostat t.max. 500°C 50-500°C rotation 270° ED ø 59mm ID ø 45.5mm				
	112407			—
knob dial plate silver thermostat t.max. 500°C 50-500°C rotation 270° ED ø 59mm ID ø 45.5mm				
	112411			—
knob dial plate silver thermostat t.max. 500°C 50-500°C rotation 310° ED ø 59mm ID ø 45.5mm				
	112448			—
knob dial plate silver thermostat t.max. 100°C 40-100°C rotation 270° ED ø 59mm ID ø 45.5mm				
	112450			—
knob adapter shaft ø 8x6.5mm L 0mm				
	112457			—
knob dial plate black/yellow energy regulator 1-circuit t.max.°C turn direction clockwise ED ø 59mm ID ø 45.5mm				
	112461			—
knob dial plate silver thermostat t.max. 190°C 120-190°C rotation 270° ED ø 59mm ID ø 45.5mm				
	112514			—
knob adapter shaft ø 10x8mm L 6mm				
	112515			—
knob adapter shaft ø 8x6.5mm L 6mm				
	112516			—
knob adapter shaft ø 6x4.6mm L 6mm				
	112522			—
knob dial plate silver energy regulator 1-3 t.max.°C turn direction anti clockwise ED ø 59mm ID ø 45.5mm				
	112601			—
knob dial plate silver gas thermostat MERTIK 1-8 t.max.°C ED ø 59mm ID ø 45.5mm				
	112602			—
knob dial plate red gas thermostat MERTIK 1-8 t.max.°C ED ø 59mm ID ø 45.5mm				
	112651			—
knob dial plate universal black				





 <p>1</p>			
<b>Part No.</b>	112343	<b>Ref. No.</b>	N/A
<b>description</b>	knob adapter shaft $\varnothing$ 10mm L 0mm with screw		

 <p>1</p>			
<b>Part No.</b>	112174	<b>Ref. No.</b>	N/A
<b>description</b>	knob adapter shaft $\varnothing$ 10x8mm L 0mm		

 <p>1</p>			
<b>Part No.</b>	112311	<b>Ref. No.</b>	N/A
<b>description</b>	knob adapter shaft $\varnothing$ 6x4.6mm L 0mm with spring		

 <p>1</p>			
<b>Part No.</b>	112178	<b>Ref. No.</b>	N/A
<b>description</b>	knob adapter shaft $\varnothing$ 8x5mm L 0mm		

 <p>1</p>			
<b>Part No.</b>	112179	<b>Ref. No.</b>	N/A
<b>description</b>	knob adapter shaft $\varnothing$ 9x6.5mm L 0mm		

 <p>1</p>			
<b>Part No.</b>	110549	<b>Ref. No.</b>	N/A
<b>description</b>	knob dial plate red thermostat t.max. 300°C 50-300°C rotation 270° ED $\varnothing$ 59mm ID $\varnothing$ 45.5mm		

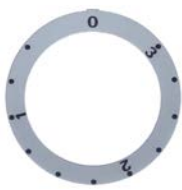
 <p>1</p>			
<b>Part No.</b>	110551	<b>Ref. No.</b>	N/A
<b>description</b>	knob dial plate silver energy regulator 1-3 t.max. °C turn direction clockwise ED $\varnothing$ 59mm ID $\varnothing$ 45.5mm		

 <p>1</p>			
<b>Part No.</b>	110542	<b>Ref. No.</b>	N/A
<b>description</b>	knob dial plate silver switch 0-1-0-1 t.max. °C ED $\varnothing$ 59mm ID $\varnothing$ 45.5mm		

 <p>1</p>			
<b>Part No.</b>	111553	<b>Ref. No.</b>	N/A
<b>description</b>	knob dial plate silver switch 5-position t.max. °C ED $\varnothing$ 59mm ID $\varnothing$ 45.5mm		

 <p>1</p>			
<b>Part No.</b>	110552	<b>Ref. No.</b>	N/A
<b>description</b>	knob dial plate silver switch 7-position t.max. °C ED $\varnothing$ 59mm ID $\varnothing$ 45.5mm		

 <p>1</p>			
<b>Part No.</b>	112267	<b>Ref. No.</b>	N/A
<b>description</b>	knob dial plate silver thermostat t.max. 180°C 100-180°C rotation 270° ED $\varnothing$ 59mm ID $\varnothing$ 45.5mm		



## baskets

## fryer baskets

## HEIDEBRENNER



1

<b>Part No.</b>	970149	<b>Ref. No.</b>	98856
<b>description</b>	fryer basket L1 340mm W1 310mm H1 125mm		

## gaskets

## sealing washers

## aluminium gaskets



1

<b>Part No.</b>	101293	<b>Ref. No.</b>	94481
<b>description</b>	flat gasket aluminium ED ø 14mm ID ø 10.3mm for pilot burner Qty 1 pcs		

## fastening material

## nuts

## hexagonal nuts

## hexagonal nuts metric (without norm)



1

<b>Part No.</b>	101501	<b>Ref. No.</b>	93282
<b>description</b>	nut thread M12x0.75 H 2mm WS 16 brass Qty 1 pcs		



1

<b>Part No.</b>	102067	<b>Ref. No.</b>	93123
<b>description</b>	nut thread M8x1 H 3mm brass Qty 1 pcs type SEF 1		



**GASTRO**PARTS.COM

