



**GASTROPARTS**

# Hatco

- [EN]** Equipment
- [DE]** Geräte
- [ES]** Aparatos
- [FR]** Équipement
- [IT]** Attrezzature
- [PL]** Urządzenia
- [RU]** Оборудование

✉ [gastroparts@gastroparts.com](mailto:gastroparts@gastroparts.com)

☎ +48 56 657 00 66

📘 [fb.com/gastroparts.global](https://fb.com/gastroparts.global)

**GASTROPARTS.COM**







## heating elements

### heating elements for hot counters

 <p>1</p>			
<b>Part No.</b>	418720	<b>Ref. No.</b>	X02.05.619.00
<b>description</b>	heating element 350W 220V heating circuits 1 L 133mm W 116mm H 113mm W1 41mm W2 34mm tube ø 8mm connection male faston 6.3mm L1 17mm L2 116mm rectangular flange hole distance 56mm flange length 70mm flange width 16mm hole ø 3mm		
<b>For models:</b>	FLVM1X		

 <p>1</p>			
<b>Part No.</b>	418721	<b>Ref. No.</b>	02.05.679.00 X02.09.258.00
<b>description</b>	heating element 700W 220V L 210mm W 85mm H 40mm tube ø 7mm connection male faston 6.3mm bracket mounting hole ø 5mm hole distance 66mm mounting distance 78mm heating circuits 1 lug length 25mm lug width 12.5mm dry heating element connection length 17mm mounting pos. upper		

 <p>1</p>			
<b>Part No.</b>	418724	<b>Ref. No.</b>	X02.09.261.00
<b>description</b>	heating element 900W 220V L 290mm W 110mm H 40mm tube ø 7mm connection male faston 6.3mm with strap hole ø 5mm mounting thread 103 hole distance 66mm heating circuits 1 lug length 25mm lug width 12.5mm dry heating element connection length 17mm mounting pos. lower		

### heating elements for chargrills

 <p>1</p>			
<b>Part No.</b>	417716	<b>Ref. No.</b>	02.08.101.00 2-08-101 R02.08.101D.00 R02-08-101
<b>description</b>	heating element 500W 115V heating circuits 1 L 485mm lug length 38mm lug width 25mm tube ø 6.5mm suitable for HATCO		

 <p>1</p>			
<b>Part No.</b>	417538	<b>Ref. No.</b>	R02.09.205.00 R02.09.205E.00
<b>description</b>	heating element 275W 220V L 34mm Wmm Hmm heating circuits 1		

### heating elements for salamanders/toast-

 <p>1</p>			
<b>Part No.</b>	418723	<b>Ref. No.</b>	X02.09.260.00
<b>description</b>	heating element 1000W 220V L 290mm W 90mm H 40mm tube ø 7mm connection male faston 6.3mm with strap hole ø 5mm hole distance 66mm mounting distance 83mm heating circuits 1 lug length 25mm lug width 12.5mm dry heating element connection length 17mm mounting pos. upper		

 <p>1</p>			
<b>Part No.</b>	418207	<b>Ref. No.</b>	R02.08.142E.00
<b>description</b>	heating element 1100W 220V heating circuits 1 L 1095mm Wmm lug length 40mm lug width 18mm connection length 27mm connection M5 tube ø 6.3mm bracket mounting hole ø 5mm dry heating element		
<b>For models:</b>	GR 48		

 <p>1</p>			
<b>Part No.</b>	418722	<b>Ref. No.</b>	02.05.682.00 HAT02.05.682.00 X02.09.259.00
<b>description</b>	heating element 600W 220V L 210mm W 90mm H 40mm tube ø 7mm connection male faston 6.3mm with strap hole ø 5mm hole distance 66mm mounting distance 83mm heating circuits 1 lug length 25mm lug width 12.5mm dry heating element connection length 17mm mounting pos. lower		

 <p>1</p>			
<b>Part No.</b>	418208	<b>Ref. No.</b>	R02.08.143E.00
<b>description</b>	heating element 1250W 220V heating circuits 1 L 1245mm Wmm lug length 39mm lug width 25mm connection length 27mm connection M5 tube ø 6.5mm bracket mounting hole ø M4mm dry heating element		
<b>For models:</b>	GR 54		

 <p>1</p>			
<b>Part No.</b>	418209	<b>Ref. No.</b>	R02.08.144E.00
<b>description</b>	heating element 1400W 220V heating circuits 1 L 1400mm Wmm lug length 39mm lug width 25mm connection length 28mm connection M5 tube ø 6.5mm bracket mounting hole ø M4mm dry heating element		
<b>For models:</b>	GR 60		





1 			
<b>Part No.</b>	418210	<b>Ref. No.</b>	R02.08.145E.00
<b>description</b>	heating element 1560W 220V heating circuits 1 L 1565mm Wmm lug length 39mm lug width 25mm connection length 26mm connection M5 tube ø 6.5mm bracket mounting hole ø M4mm dry heating element		
<b>For models:</b>	GR 66		

2 			
<b>Part No.</b>	418211	<b>Ref. No.</b>	R02.08.148E.00
<b>description</b>	heating element 1725W 220V heating circuits 1 L 1715mm Wmm lug length 39mm lug width 25mm connection length 27mm connection M5 tube ø 6.8mm bracket mounting hole ø M4mm dry heating element		
<b>For models:</b>	GR 72		

1 			
<b>Part No.</b>	418203	<b>Ref. No.</b>	R02.08.138E.00
<b>description</b>	heating element 350W 220V heating circuits 1 L 335mm Wmm lug length 40mm lug width 18mm connection M5 tube ø 6.3mm rectangular flange mounting pos. dry heating element hole ø 5mm		
<b>For models:</b>	GR 18		

1 			
<b>Part No.</b>	418202	<b>Ref. No.</b>	R02.08.103.00 R02.08.103E.00 R02.08.136E.00 R02.8.103E.00
<b>description</b>	heating element 500W 220V heating circuits 1 L 485mm Wmm lug length 40mm lug width 18mm connection M5 tube ø 6.3mm rectangular flange hole ø M4mm dry heating element		
<b>For models:</b>	GR 24		

1 			
<b>Part No.</b>	418204	<b>Ref. No.</b>	R02.08.139E.00
<b>description</b>	heating element 660W 220V heating circuits 1 L 634mm Wmm lug length 40mm lug width 18mm connection male faston tube ø 6.5mm rectangular flange hole ø 4mm dry heating element		
<b>For models:</b>	GR 30		

1 			
<b>Part No.</b>	418205	<b>Ref. No.</b>	R02.08.140E.00
<b>description</b>	heating element 800W 220V heating circuits 1 L 790mm Wmm lug length 40mm lug width 18mm connection length 26mm connection M5 tube ø 6.3mm rectangular flange hole ø 5mm dry heating element flange length 40mm flange width 18mm		
<b>For models:</b>	GR 36		

1 			
<b>Part No.</b>	418206	<b>Ref. No.</b>	R02.08.141E.00
<b>description</b>	heating element 950W 220V L 940mm Wmm lug length 40mm lug width 18mm tube ø 6.3mm dry heating element flange length 40mm flange width 18mm		
<b>For models:</b>	GR 42		

## heating elements for heated cabinets

1 			
<b>Part No.</b>	420568	<b>Ref. No.</b>	R02.08.003.00
<b>description</b>	heating element 350W 240V heating circuits 1 L 540mm flange length 38mm flange width 25mm connection M4 tube ø 6.5mm		



## coil heating elements

1 			
<b>Part No.</b>	418719	<b>Ref. No.</b>	X02.05.620.00
<b>description</b>	heating element 1000W 230V L 180mm W 80mm H 84mm tube ø 22mm connection male faston 6.3mm connection length 36mm dry heating element heating circuits 1 bracket mounting		
<b>For models:</b>	FLVM1X		

## energy regulators

## EGO

## 1-circuit

1 			
<b>Part No.</b>	380666	<b>Ref. No.</b>	R02.19.019.00
<b>description</b>	energy regulator		
<b>For models:</b>	GRAH18, GRAH30, GRAH42, GRAH54		
<b>accessories for</b>	380666		
	<b>Part No.</b>	111825	<b>Ref. No.</b> 05.30.043.00 R05.30.043.00
	knob switch zero mark ø 30mm shaft ø 6x4.6mm shaft flat right silver		
	<b>Part No.</b>	112946	<b>Ref. No.</b> 07.01.034.00
	bezel 0-7 dimensions 51x60mm		

## thermostats

## bi-metal thermostats

## bi-metal thermostats

1 			
<b>Part No.</b>	390447	<b>Ref. No.</b>	X02.16.138.00
<b>description</b>	bi-metal thermostat hole distance 23.5mm switch-off temp. 130°C NC 1-pole 10A 250V connection F6.3		
<b>For models:</b>	FLVM1X		



			
1			
<b>Part No.</b>	390511	<b>Ref. No.</b>	R02.16.029.00
<b>description</b>	bi-metal thermostat hole distancemm switch-off temp. 78°C 1NC 1-pole 10A connection F4.8		

## control and safety thermostats

### IMIT / TEMPOMATIC / ARTHERMO



#### control thermostats

			
1			
<b>Part No.</b>	375891	<b>Ref. No.</b>	X02.16.136.00
<b>description</b>	thermostat t.max. 85°C temperature range 0-85°C 1-pole 1CO 15A probe ø 6mm probe L 78mm capillary pipe 1000mm capillary pipe isolatedmm gland nut shaft ø 6x4.6mm shaft L 15mm probe material SS		
<b>For models:</b>	FLVM1X		

## switches and momentary switches



### rocker/momentary rocker switches

#### 30x11mm

			
1			
<b>Part No.</b>	301010	<b>Ref. No.</b>	X02.19.180.00
<b>description</b>	rocker switch mounting measurements 30x11mm red 1NO/indicator light 250V 16A 0-1 connection male faston 6.3mm ambient temperature max. 85/125°C protection IP40		
<b>For models:</b>	FLVM1X		
<b>accessories for</b>	301010		
	<b>Part No.</b>	301035	<b>Ref. No.</b> —
	protective cover mounting measurements 30x11mm		

### toggle switches

#### M12x0.75

			
1			
<b>Part No.</b>	301230	<b>Ref. No.</b>	R02.19.008A.00
<b>description</b>	toggle switch thread M12x0.75 2NO 250V 15A ON-OFF screw		
<b>For models:</b>	GRAH18, GRAH30, GRAH42, GRAH54		
<b>accessories for</b>	301230		
	<b>Part No.</b>	112947	<b>Ref. No.</b> 07.01.035.00
	bezel L 60mm W 51mm		
	<b>Part No.</b>	691506	<b>Ref. No.</b> 07.01.214.00
	plate for toggle switch		

<b>accessories for</b>	301230		
	<b>Part No.</b>	691507	<b>Ref. No.</b> 04.08.240.00
	cover for toggle switch		

#### accessories

			
1			
<b>Part No.</b>	112947	<b>Ref. No.</b>	07.01.035.00
<b>description</b>	bezel L 60mm W 51mm		
<b>For models:</b>	GRAH18, GRAH30, GRAH42, GRAH54		

			
1			
<b>Part No.</b>	691507	<b>Ref. No.</b>	04.08.240.00
<b>description</b>	cover for toggle switch		
<b>For models:</b>	GRAH18, GRAH30, GRAH42, GRAH54		

			
1			
<b>Part No.</b>	691506	<b>Ref. No.</b>	07.01.214.00
<b>description</b>	plate for toggle switch		
<b>For models:</b>	GRAH18, GRAH30, GRAH42, GRAH54		

## microswitches

### lever actuated

			
1			
<b>Part No.</b>	347021	<b>Ref. No.</b>	X02.19.186.00
<b>description</b>	microswitch with lever 250V 5A 1CO connection soldering connection L 15mm ambient temperature max. 85°C mounting distance 10mm actuating force: 13g lever length 17mm		

## float switches

			
1			
<b>Part No.</b>	402061	<b>Ref. No.</b>	X02.01.249.00
<b>description</b>	float switch thread 9.7 1NO ø 26mm L 130mm mounting ø 10mm 230V 0.5A cable cable length 500mm		
<b>For models:</b>	FLVM1X		



cam switches

4-position



<b>Part No.</b>	300022	<b>Ref. No.</b>	X02.19.174.00
<b>description</b>	cam switch 4 operating positions 2CO sequence 0-1-2-3 16A shaft ø 6x4.6mm shaft L 23mm connection screw		

magnetic switches

accessories

magnets



<b>Part No.</b>	691503	<b>Ref. No.</b>	X05.30.099.00
<b>description</b>	magnet for door		
<b>For models:</b>	FLVM1X		

encoders and potentiometers



<b>Part No.</b>	402057	<b>Ref. No.</b>	02.13.338.00 02.13.340.00 X02.13.330.00
<b>description</b>	potentiometer 0.5KOhm rotation 320° shaft ø 6mm shaft L 12.8mm 25W 230V type FVR25W cable length 150mm		
<b>accessories for</b>	402057		

	<b>Part No.</b>	112939	<b>Ref. No.</b>	X05.30.098.00 X05.30.098.00 old
	knob switch zero mark ø 45mm shaft ø 6mm			

lamps

indicator lights

indicator lights (complete)

ø12mm

with plug-in socket



<b>Part No.</b>	359041	<b>Ref. No.</b>	X02.19.175.00 X02.19.182.00
<b>description</b>	indicator light ø 12mm green 230V connection male faston 6.3mm temp.-resist. 120°C Qty 1 pcs		
<b>For models:</b>	FLVM1X		



<b>Part No.</b>	359043	<b>Ref. No.</b>	X02.19.176.00 X02.19.181.00
<b>description</b>	indicator light ø 12mm red 230V connection male faston 6.3mm temp.-resist. 120°C Qty 1 pcs		
<b>For models:</b>	FLVM1X		



<b>Part No.</b>	580014	<b>Ref. No.</b>	2-19-029 2-19-154
<b>description</b>	indicator light ø 12mm 230V red		

ø12.5mm



<b>Part No.</b>	357009	<b>Ref. No.</b>	02.19.150.00
<b>description</b>	indicator light ø 12.5mm 230V green connection male faston 4.8mm		
<b>For models:</b>	GRAH18, GRAH30, GRAH42, GRAH54		

screw-on/push-on fit

light bulbs

for lighting



<b>Part No.</b>	359849	<b>Ref. No.</b>	R02.30.058.00
<b>description</b>	light bulb t.max.°C socket E27 230V 60W ø 48mm L 102mm lens L 75mm PTFE coated for HATCO heated bridge GR Qty 1 pcs		



oven lamps

producer-specific oven lamps

HATCO



1

<b>Part No.</b>	359500	<b>Ref. No.</b>	X02.30.102.00
<b>description</b>	lamp socket 250V socket E27 connection cable 250mm ø 35mm H 38mm mounting distancemm Qty 1 pcs		
<b>For models:</b>	FLVM1X		



1

<b>Part No.</b>	359848	<b>Ref. No.</b>	02.30.045.00 R02.30.045.00
<b>description</b>	lamp socket socket E27 double for HATCO heated bridge GR		



1

<b>Part No.</b>	359847	<b>Ref. No.</b>	02.30.044.00 R02.30.044.00
<b>description</b>	lamp socket socket E27 for HATCO heated bridge GR		

lamps

light bulbs



1

<b>Part No.</b>	359849	<b>Ref. No.</b>	R02.30.058.00
<b>description</b>	light bulb t.max.°C socket E27 230V 60W ø 48mm L 102mm lens L 75mm PTFE coated for HATCO heated bridge GR Qty 1 pcs		

contactors

HARTLAND

power contactors



1

<b>Part No.</b>	580012	<b>Ref. No.</b>	2-01-018
<b>description</b>	contactor resistive load 50A 240VAC 40A/10HP (AC3/240V) 40A/7.46kW main contacts 4NO connection screw clamp/male faston 6.3mm type HCCY4XU04CG		

electronics

PCBs



1

<b>Part No.</b>	401799	<b>Ref. No.</b>	CM33580150
<b>description</b>	PCB ice maker N201/N301//N501 230V		
<b>accessories for</b>	401799		
	<b>Part No.</b>	<b>Ref. No.</b>	—
	connection cable L 1300mm 2-pole level sensor suitable for ice maker connection plug plug type coded plug		



1

<b>Part No.</b>	403125	<b>Ref. No.</b>	76-2782-3
<b>description</b>	PCB L 175mm W 99mm for ice-cube maker		



## keypads

## front foils



1

Part No.	402059	Ref. No.	X07.03.465.00
----------	--------	----------	---------------

description	front foil toaster TOASTMAX L 185mm W 85mm
-------------	--



1

Part No.	402060	Ref. No.	X07.03.466.00
----------	--------	----------	---------------

description	front foil toaster TOASTMAX L 265mm W 85mm
-------------	--

## solenoid valves

## solenoid valves (water)

## ELBI



1

Part No.	373001	Ref. No.	65010554
----------	--------	----------	----------

description	solenoid valve single straight 230VAC inlet 3/4" outlet 11.5mm input/min output 2l/min 50/60Hz DN10 t.max. 90°C duty cycle 100% ELBI plastic
-------------	--

## fans

## axial fans

## import



1

Part No.	601080 <sup>1</sup>	Ref. No.	X02.12.082.00
----------	---------------------	----------	---------------

description	axial fan L 119mm W 119mm H 38mm 230VAC 50/60Hz 23/20W bearing ball bearing connection male faston 2.8mm metal ADDA fan wheel ø 110mm temp.-resist. 70°C
-------------	--

accessories for	601080
-----------------	--------

Part No.	550898	Ref. No.	—
----------	--------	----------	---

connecting cable	cable length 2000mm connection F 2.8 connection distance 7.9mm for axial flow fan
------------------	---

Part No.	692519	Ref. No.	—
----------	--------	----------	---

guard	L 120mm W 120mm plastic
-------	-------------------------

<sup>1</sup>with ball bearings

1

Part No.	601055 <sup>1</sup>	Ref. No.	X02.12.093.00
----------	---------------------	----------	---------------

description	axial fan L 92mm W 92mm H 25mm 230VAC 50/60Hz 14.5/14W bearing ball bearing connection male faston 2.8mm metal ADDA fan wheel ø 85mm temp.-resist. 70°C
-------------	---

For models:	FLVM1X
-------------	--------

accessories for	601055
-----------------	--------

Part No.	550898	Ref. No.	—
connecting cable	cable length 2000mm connection F 2.8 connection distance 7.9mm for axial flow fan		

Part No.	691103	Ref. No.	—
----------	--------	----------	---

guard	ø 90mm mounting distance 83mm for axial fan 92mm
-------	--

<sup>1</sup>with ball bearings

## motors

## gear motors

## miscellaneous

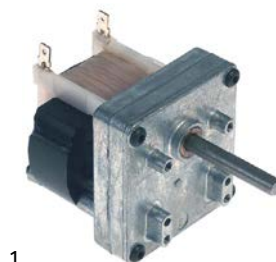

1

Part No.	601483	Ref. No.	02.12.079.00
----------	--------	----------	--------------

description	gear motor MERKLE type 4515UI-063 230V 50Hz 11rpm shaft ø 7x8mm L 125mm W 76mm H 69mm for toaster
-------------	---

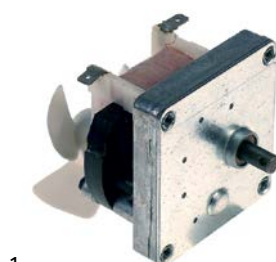

1

Part No.	601484	Ref. No.	02.12.026.00
----------	--------	----------	--------------

description	gear motor MK type S4355L 230V 50Hz shaft ø 7x8mm L 76mm W 70mm H 92mm for hot display
-------------	--



## pumps

### pumps for ice machines



1

<b>Part No.</b>	500752	<b>Ref. No.</b>	62043002
<b>description</b>	pump GRE 60W 230V 60Hz inlet ø 16mm outlet ø 21mm L 110mm rotation direction right for ice maker		



1

<b>Part No.</b>	499122	<b>Ref. No.</b>	7626013
<b>description</b>	pump NBK MOTORS type YSP6PJDFV2 208-240V 50/60Hz outlet ø 26mm L 210mm rotation direction right for ice-cube maker		

## condensators & interference suppression filters

### filters

#### RC circuits



1

<b>Part No.</b>	365076	<b>Ref. No.</b>	02.13.306.00
<b>description</b>	RC circuit 110-240V 50/60Hz conductor 2 connection cable Qty 1 pcs		
<b>For models:</b>	GRAH18, GRAH30, GRAH42, GRAH54		

## fuses

### fine fuses



1

<b>Part No.</b>	358611	<b>Ref. No.</b>	63001510
<b>description</b>	fine fuse size ø5x20mm 16A fast-acting rated 250V Qty 10 pcs		



1

<b>Part No.</b>	358028	<b>Ref. No.</b>	510127
<b>description</b>	fine fuse size ø10x38mm 20A rated 500V type Gg fast-acting Qty 1 pcs		

## electric accessories

### terminals

#### terminal blocks



1

<b>Part No.</b>	550232	<b>Ref. No.</b>	R02.15.030.00
<b>description</b>	lustre terminal 12-pole cross section 2.5mm <sup>2</sup> max. 32A max 450V temp.-resist. 150°C		
<b>For models:</b>	GRAH18, GRAH30, GRAH42, GRAH54		



1

<b>Part No.</b>	508353	<b>Ref. No.</b>	X02.15.052.00
<b>description</b>	lustre terminal 3-pole cross section 4mm <sup>2</sup> max. 32A max 750V temp.-resist. 150°C		

## equipment-specific units

### for ice-cube maker

#### probes



1

<b>Part No.</b>	694544	<b>Ref. No.</b>	76-2781-3
<b>description</b>	sensor for ice thickness 1-pole cable length 1450mm		



1

<b>Part No.</b>	694545	<b>Ref. No.</b>	76-0160-3
<b>description</b>	sensor for ice thickness 1-pole cable length 300mm		





## valves

## intake valves



1

<b>Part No.</b>	694548	<b>Ref. No.</b>	0200361201
<b>description</b>	intake valve with float		



1

<b>Part No.</b>	695613	<b>Ref. No.</b>	8369133
<b>description</b>	intake valve with float		

## for toasters

## miscellaneous



1

<b>Part No.</b>	691472	<b>Ref. No.</b>	X05.03.040.00
<b>description</b>	chain US norm 25-1 splitting 6mm links 30 internal width 3.3mm roller ø 4.3mm single closed		



1

<b>Part No.</b>	691473	<b>Ref. No.</b>	X05.03.044.00
<b>description</b>	chain US norm 25-1 splitting 6mm links 31 internal width 3.3mm roller ø 4.3mm single closed		



1

<b>Part No.</b>	694056	<b>Ref. No.</b>	05.03.036.00 X05.03.042.00
<b>description</b>	conveyor belt L 570mm W 260mm wire gauge ø 1.2mm for conveyor toaster		



1

<b>Part No.</b>	694057	<b>Ref. No.</b>	X05.03.041.00
<b>description</b>	conveyor belt L 580mm W 180mm wire gauge ø 1.2mm for conveyor toaster		



1

<b>Part No.</b>	694059	<b>Ref. No.</b>	X05.07.025.00
-----------------	--------	-----------------	---------------

**description** drive shaft ø 9.5mm L 235mm

**accessories for** 694059



<b>Part No.</b>	691470	<b>Ref. No.</b>	X05.03.043.00
<b>description</b>	retaining ring E D1 ø 8mm D2 ø 16mm SS DIN 6799 thickness 1mm for shaft ø 9-12mm		



<b>Part No.</b>	694060	<b>Ref. No.</b>	X05.02.024.00
-----------------	--------	-----------------	---------------

**description** flange for spindle



1

<b>Part No.</b>	694058	<b>Ref. No.</b>	X05.07.026.00
-----------------	--------	-----------------	---------------

**description** drive shaft ø 9.5mm L 320mm

**accessories for** 694058



<b>Part No.</b>	691470	<b>Ref. No.</b>	X05.03.043.00
<b>description</b>	retaining ring E D1 ø 8mm D2 ø 16mm SS DIN 6799 thickness 1mm for shaft ø 9-12mm		



<b>Part No.</b>	694060	<b>Ref. No.</b>	X05.02.024.00
-----------------	--------	-----------------	---------------

**description** flange for spindle



			
1			
<b>Part No.</b>	694060	<b>Ref. No.</b>	X05.02.024.00
<b>description</b>	flange for spindle		

gear wheels

			
1			
<b>Part No.</b>	691474	<b>Ref. No.</b>	X05.09.052.00 X05.09.053.00
<b>description</b>	sprocket-wheel DIN/ISO splitting 25-1 teeth 24 shaft intake ø 19mm H 18mm hub ø 19mm metal ø 50mm		

			
1			
<b>Part No.</b>	691475	<b>Ref. No.</b>	05.09.055.00 X05.09.054.00 X05.09.055.00
<b>description</b>	sprocket-wheel DIN/ISO splitting 25-1 teeth 36 shaft intake ø 9.5mm H 18mm hub ø 19mm metal ø 74mm		

for heated display cases

miscellaneous

			
1			
<b>Part No.</b>	691508	<b>Ref. No.</b>	X04.17.1054.00
<b>description</b>	rotation plate		

knobs

producer-specific knobs

HATCO

			
1			
<b>Part No.</b>	111825	<b>Ref. No.</b>	05.30.043.00 R05.30.043.00
<b>description</b>	knob switch zero mark ø 30mm shaft ø 6x4.6mm shaft flat right silver		
<b>For models:</b>	GRAH18, GRAH30, GRAH42, GRAH54		

			
1			
<b>Part No.</b>	112939	<b>Ref. No.</b>	X05.30.098.00 X05.30.098.00 old
<b>description</b>	knob switch zero mark ø 45mm shaft ø 6mm		
<b>For models:</b>	FLVM1X		

			
1			
<b>Part No.</b>	112712	<b>Ref. No.</b>	05.30.020.00 X05.30.020.00 X05.30.098.00
<b>description</b>	knob switch zero mark t.max.°C ø 38mm shaft ø 6mm shaft flat		

accessories

fascias

			
1			
<b>Part No.</b>	112946	<b>Ref. No.</b>	07.01.034.00
<b>description</b>	bezel 0-7 dimensions 51x60mm		
<b>For models:</b>	GRAH18, GRAH30, GRAH42, GRAH54		

equipment feet and end caps

equipment feet

with screw mounting

			
1			
<b>Part No.</b>	691476	<b>Ref. No.</b>	05.30.007.00 X05.30.092.00
<b>description</b>	equipment foot thread 3/8"-16UNC thread L 12mm H 101-135mm plastic size 1½" Qty 1 pcs		



## transmission technology and ball bearings

### chains

#### roller chains 25-1 single



1

<b>Part No.</b>	691472	<b>Ref. No.</b>	X05.03.040.00
<b>description</b>	chain US norm 25-1 splitting 6mm links 30 internal width 3.3mm rollerø 4.3mm single closed		



1

<b>Part No.</b>	691473	<b>Ref. No.</b>	X05.03.044.00
<b>description</b>	chain US norm 25-1 splitting 6mm links 31 internal width 3.3mm rollerø 4.3mm single closed		

## measuring equipment

### thermometers

#### built-in thermometers

#### external power supply



1

<b>Part No.</b>	403623	<b>Ref. No.</b>	X02.16.137.00
<b>description</b>	thermometer mounting measurements 65x20mm 220V 0 up to +99°C cable length 2900mm probe ø 6mm probe L 25mm		
<b>For models:</b>	FLVM1X		

## fastening material

### fasteners

#### retainer clips



1

<b>Part No.</b>	691471	<b>Ref. No.</b>	X05.04.531.00
<b>description</b>	retainer clip L 48mm wire gauge ø 2.3mm stainless steel Qty 1 pcs		

### retaining rings

#### DIN 6799



1

<b>Part No.</b>	691470	<b>Ref. No.</b>	X05.03.043.00
<b>description</b>	retaining ring E D1 ø 8mm D2 ø 16mm SS DIN 6799 thickness 1mm for shaft ø 9-12mm		

## consumables

### fuses

#### fine fuses



1

<b>Part No.</b>	358611	<b>Ref. No.</b>	63001510
<b>description</b>	fine fuse size ø5x20mm 16A fast-acting rated 250V Qty 10 pcs		

#### ø10x38mm 500V



1

<b>Part No.</b>	358028	<b>Ref. No.</b>	510127
<b>description</b>	fine fuse size ø10x38mm 20A rated 500V type Gg fast-acting Qty 1 pcs		

**GASTRO**PARTS.COM

