



**GASTROPARTS**

# Gico

**[EN]** Equipment

**[DE]** Geräte

**[ES]** Aparatos

**[FR]** Équipement

**[IT]** Attrezzature

**[PL]** Urządzenia

**[RU]** Оборудование

✉ [gastroparts@gastroparts.com](mailto:gastroparts@gastroparts.com)

☎ +48 56 657 00 66

📘 [fb.com/gastroparts.global](https://fb.com/gastroparts.global)

**GASTROPARTS.COM**





## heating elements

### heating elements for ovens

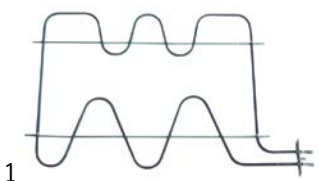

1

<b>Part No.</b>	416090	<b>Ref. No.</b>	260200070
<b>description</b>	heating element 2000W 230V L 500mm W 325mm L1 73mm L2 427mm W1 295mm W2 30mm flange length 70mm flange width 22mm hole distance 56mm hole ø M4mm tube ø 6.3mm connection length 22mm heating circuits 1 rectangular flange dry heating element oven		
<b>For models:</b>	64-040FE, 64-050FE-FEV, 64-057T, 64-222FE		

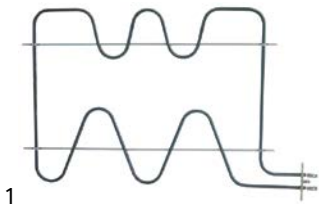

1

<b>Part No.</b>	416089	<b>Ref. No.</b>	260203130
<b>description</b>	heating element 2000W 400V L 500mm W 325mm L1 73mm L2 427mm W1 295mm W2 30mm flange length 70mm flange width 22mm hole distance 55mm hole ø M4mm tube ø 6.5mm connection length 22mm connection M4 heating circuits 1 rectangular flange dry heating element oven		
<b>For models:</b>	500-050FE		
<b>accessories for</b>	416089		
	<b>Part No.</b>	510368	<b>Ref. No.</b> —
	gasket L 70mm W 23.5mm hole ø 5mm hole distance 56mm FIBER thickness 2mm for heating element		

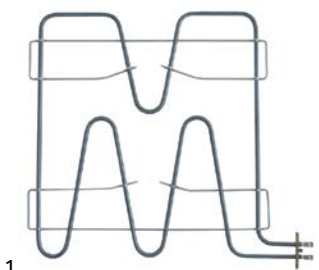



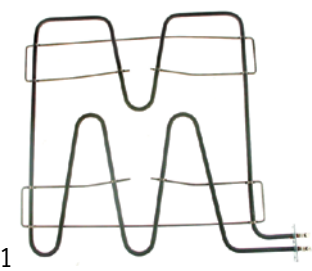

1

<b>Part No.</b>	416091	<b>Ref. No.</b>	270200402
<b>description</b>	heating element 2740W 230V L 500mm W 485mm L1 68mm L2 430mm W1 450mm W2 32mm flange length 70mm flange width 22mm hole distance 56mm hole ø M4mm tube ø 8.5mm connection M4 heating circuits 1 rectangular flange dry heating element oven		
<b>spare parts for</b>	416091		
	<b>Part No.</b>	510368	<b>Ref. No.</b> —
	gasket L 70mm W 23.5mm hole ø 5mm hole distance 56mm FIBER thickness 2mm for heating element		



1

<b>Part No.</b>	416092	<b>Ref. No.</b>	270203360
<b>description</b>	heating element 2740W 400V L 500mm W 485mm L1 68mm L2 430mm W1 450mm W2 32mm flange length 70mm flange width 22mm hole distance 56mm hole ø M4mm tube ø 8.5mm connection M4 heating circuits 1 mounting thread M3 rectangular flange dry heating element oven		
<b>For models:</b>	700-040FEB, 700-050FEB, 700-052FEB, 700-054FEB, 700-055FEB, 700-057FEB, 700-138FEBA, 700-162FEBA, 700-200FEB, 700-222FEB, 700-224FEBA, 700-411B		
<b>accessories for</b>	416092		
	<b>Part No.</b>	510368	<b>Ref. No.</b> —
	gasket L 70mm W 23.5mm hole ø 5mm hole distance 56mm FIBER thickness 2mm for heating element		
	<b>Part No.</b>	527169	<b>Ref. No.</b> —
	hexagonal nut thread M3 H 2.8mm WS 5.5 brass Qty 1 pcs		
	<b>Part No.</b>	560110	<b>Ref. No.</b> —
	plain washer ID ø 3.2mm ED ø 7mm thickness 0.5mm SS Qty 20 pcs DIN 125A for thread M3		
	<b>Part No.</b>	560130	<b>Ref. No.</b> —
	hexagonal nut thread M3 H 2.4mm WS 5.5 SS DIN/ISO DIN 934 / ISO 4032/8673 Qty 20 pcs		

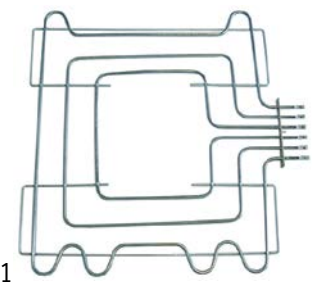

1

<b>Part No.</b>	416093	<b>Ref. No.</b>	241200922
<b>description</b>	heating element 3275W 230/400V heating circuits 3 L 538mm W 615mm L1 38mm L2 500mm W1 248mm W2 127mm flange length 160mm flange width 22mm hole distance 144mm hole ø M5mm tube ø 6.5mm connection M4 connection length 60mm rectangular flange dry heating element		

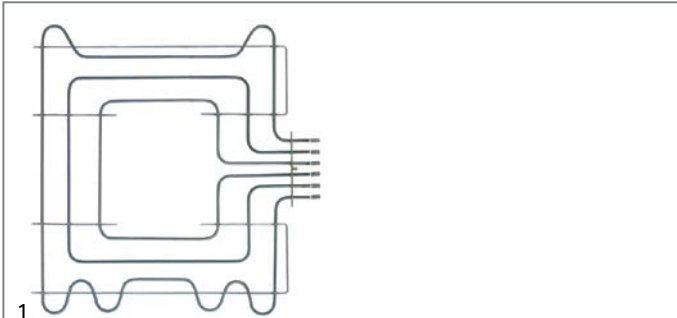
1

<b>Part No.</b>	416087	<b>Ref. No.</b>	290203720
<b>description</b>	heating element 3275W 400V heating circuits 3 L 538mm W 615mm L1 38mm L2 500mm W1 248mm W2 127mm flange length 160mm flange width 22mm hole distance 144mm hole ø 5mm tube ø 6.5mm connection M4 connection length 60mm rectangular flange dry heating element		
<b>For models:</b>	900-040FE, 900-050FE, 900-052FE, 900-054FE, 900-057FE, 900-138FEA, 900-162FEA, 900-172FEA, 900-182FE, 900-200FE, 900-411-413, 920-050FE, 920-052FE, 920-057FE, 920-122FELC, 920-122FELFELR-FER, 920-122FELR, 920-122FER, 920-172FEA, 920-200FE, 920-322FEL-FELC-FELR-FER		

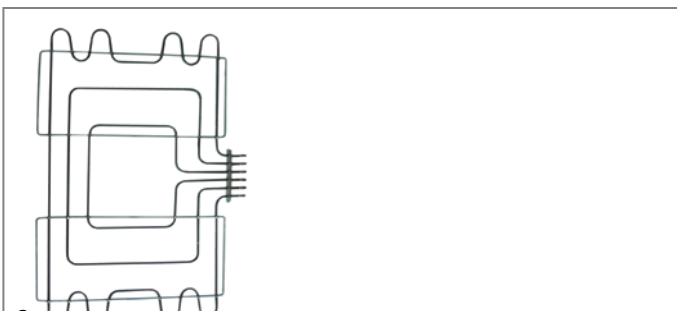

2

<b>Part No.</b>	416094	<b>Ref. No.</b>	211200020
<b>description</b>	heating element 4300W 230/400V heating circuits 3 L 530mm W 843mm L1 32mm L2 498mm W1 359mm W2 127mm flange length 161mm flange width 23mm bridge length 550mm hole distance 143mm hole ø M5mm tube ø 6.6mm connection M4 connection length 54mm rectangular flange dry heating element oven		

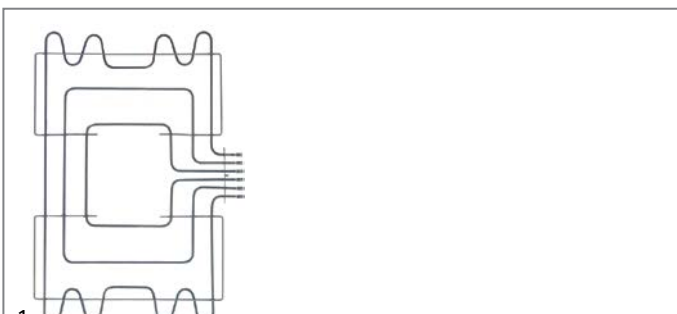

1

<b>Part No.</b>	416088	<b>Ref. No.</b>	211200240
<b>description</b>	heating element 4300W 400V heating circuits 3 L 530mm W 843mm L1 32mm L2 498mm W1 359mm W2 127mm flange length 161mm flange width 23mm bridge length 550mm hole distance 143mm thread M5 tube ø 7.1mm connection M4 connection length 52mm rectangular flange dry heating element		
<b>For models:</b>	110-050FE, 110-052FE, 110-057FE, 110-122FELC, 110-122FELFELR, 110-200FE, 110-322FEL-FELC-FELR		

## heating elements for bain maries

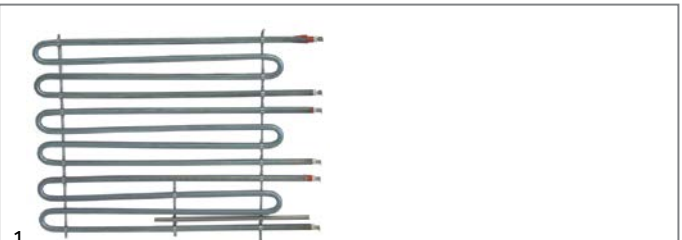

1

<b>Part No.</b>	416136	<b>Ref. No.</b>	270204530
<b>description</b>	heating element 1500W 230V heating circuits 3 L 384mm W 274mm connection male faston 6.3mm tube ø 8.5mm connection distance 71mm dry heating element		
<b>For models:</b>	700-500A-C-T, 700-542A-C-T		

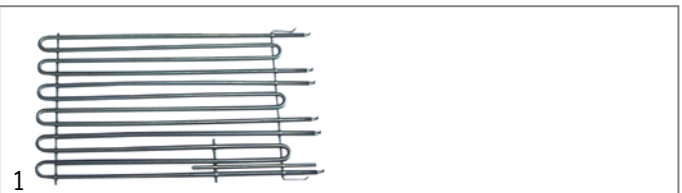

1

<b>Part No.</b>	416106	<b>Ref. No.</b>	290204050 292200160
<b>description</b>	heating element 2700W 240V heating circuits 3 L 490mm W 274mm connection male faston 6.3mm tube ø 8.5mm connection distance 15mm dry heating element thermostat sleeves ø 5.4mm length thermostat sleeves 222mm bain marie		
<b>For models:</b>	110-500A-T, 900-500A-C-T, 900-542A-C-T, 920-500A-T, 920-542A-T		

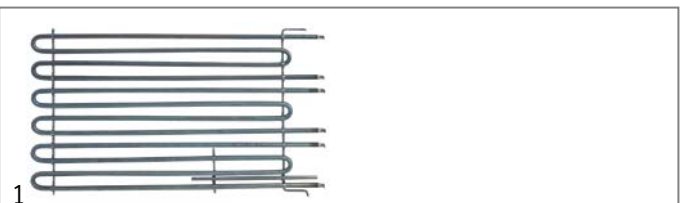

1

<b>Part No.</b>	416079	<b>Ref. No.</b>	292200160
<b>description</b>	heating element 2700W 240V heating circuits 3 L 503mm W 274mm connection male faston 6.3mm tube ø 8.5mm dry heating element thermostat sleeves ø 5mm length thermostat sleeves 222mm number of thermostat sleeves 1		



1

<b>Part No.</b>	416105	<b>Ref. No.</b>	290200091
<b>description</b>	heating element 800W 240V L 440mm W 72mm H 12mm connection male faston		



heating elements for frying pans

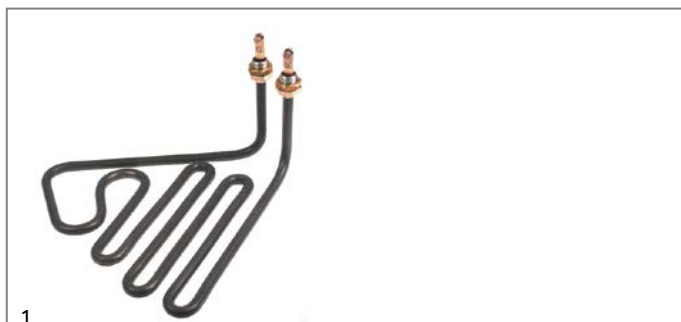

<b>Part No.</b>	416111	<b>Ref. No.</b>	A00089
<b>description</b>	heating element 2000W 240V L 200mm W 213mm tube ø 6mm 2 hole fixing thread M14x1.5 dry heating element kettle W1 178mm W2 35mm H 85mm mounting distance 34mm		
<b>For models:</b>	900-521-522		
<b>accessories for</b>	416111		
	<b>Part No.</b>	510417	<b>Ref. No.</b> —
	flat gasket fibre ED ø 20mm ID ø 14mm thickness 2mm Qty 1 pcs		
	<b>Part No.</b>	520228	<b>Ref. No.</b> —
	tooth lock washer ID ø 15.3mm ED ø 24mm steel Qty 1 pcs for thread M14		
	<b>Part No.</b>	520230	<b>Ref. No.</b> —
	nut thread M14x1.5 H 5mm WS 19 zinc-coated steel Qty 1 pcs		
	<b>Part No.</b>	521101	<b>Ref. No.</b> —
	nut thread M14x1.5 H 5mm WS 19 SS Qty 1 pcs		
	<b>Part No.</b>	550262	<b>Ref. No.</b> —
	flat gasket copper ED ø 20mm ID ø 14mm thickness 2mm		

heating elements for chip scuttles







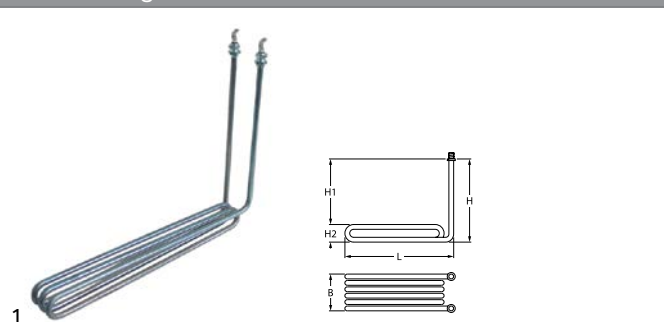

<b>Part No.</b>	416080	<b>Ref. No.</b>	284203390
<b>description</b>	heating element 1000W 240V heating circuits 1 L 315mm W 75mm flange length 110mm flange width 22mm hole distance 94mm connection length 27mm connection M4 tube ø 8.5mm rectangular flange hole ø 6mm dry heating element		
<b>For models:</b>	64-519T, 64-520T, 700-519A-C-T, 700-520T		

heating elements for fryers

2 hole fixing



<b>Part No.</b>	416084	<b>Ref. No.</b>	290203710
<b>description</b>	heating element 3000W 240V heating circuits 1 L 370mm W 45mm H 270mm H1 270mm H2 42mm thread M12x1 tube ø 8.5mm mounting distance 37mm windings 3 2 hole fixing connection M4 connection length 20mm fryer		
<b>For models:</b>	900-706A-S		
<b>spare parts for</b>	416084		
	<b>Part No.</b>	521110	<b>Ref. No.</b> —
	flat gasket fibre ED ø 20mm ID ø 13mm thickness 2mm Qty 1 pcs		
<b>accessories for</b>	416084		
	<b>Part No.</b>	520229	<b>Ref. No.</b> —
	nut thread M12x1 H 4mm WS 16 zinc-coated steel Qty 1 pcs		
	<b>Part No.</b>	521103	<b>Ref. No.</b> —
	nut thread M4 H 3mm WS 7 brass Qty 20 pcs		
	<b>Part No.</b>	521104	<b>Ref. No.</b> —
	washer ID ø 4.3mm ED ø 8mm thickness 0.5mm brass Qty 20 pcs for thread M4		
	<b>Part No.</b>	521131	<b>Ref. No.</b> —
	nut thread M12x1 H 3.5mm WS 17 SS Qty 1 pcs		
	<b>Part No.</b>	528110	<b>Ref. No.</b> —
	O-ring EPDM thickness 2.62mm ID ø 12.37mm Qty 1 pcs		
	<b>Part No.</b>	560111	<b>Ref. No.</b> —
	plain washer ID ø 4.3mm ED ø 9mm thickness 0.8mm SS Qty 20 pcs DIN 125A for thread M4		
	<b>Part No.</b>	560131	<b>Ref. No.</b> —
	hexagonal nut thread M4 H 3.2mm WS 7 SS DIN/ISO DIN 934 / ISO 4032/8673 Qty 20 pcs		





<b>Part No.</b>	416101	<b>Ref. No.</b>	260200360
<b>description</b>	heating element 2100W 240V heating circuits 1 L 260mm W 70mm H 270mm L1 12mm L2 248mm H1 15mm H2 220mm H3 35mm mounting distance 64mm thread M12x1 tube $\varnothing$ 6.3mm connection length 25mm connection M4 2 hole fixing fryer		
<b>accessories for</b>	416101		
	<b>Part No.</b>	520229	<b>Ref. No.</b> —
	nut thread M12x1 H 4mm WS 16 zinc-coated steel Qty 1 pcs		
	<b>Part No.</b>	521103	<b>Ref. No.</b> —
	nut thread M4 H 3mm WS 7 brass Qty 20 pcs		
	<b>Part No.</b>	521104	<b>Ref. No.</b> —
	washer ID $\varnothing$ 4.3mm ED $\varnothing$ 8mm thickness 0.5mm brass Qty 20 pcs for thread M4		
	<b>Part No.</b>	521110	<b>Ref. No.</b> —
	flat gasket fibre ED $\varnothing$ 20mm ID $\varnothing$ 13mm thickness 2mm Qty 1 pcs		
	<b>Part No.</b>	521131	<b>Ref. No.</b> —
	nut thread M12x1 H 3.5mm WS 17 SS Qty 1 pcs		
	<b>Part No.</b>	528110	<b>Ref. No.</b> —
	O-ring EPDM thickness 2.62mm ID $\varnothing$ 12.37mm Qty 1 pcs		
	<b>Part No.</b>	560111	<b>Ref. No.</b> —
	plain washer ID $\varnothing$ 4.3mm ED $\varnothing$ 9mm thickness 0.8mm SS Qty 20 pcs DIN 125A for thread M4		
	<b>Part No.</b>	560131	<b>Ref. No.</b> —
	hexagonal nut thread M4 H 3.2mm WS 7 SS DIN/ISO DIN 934 / ISO 4032/8673 Qty 20 pcs		

<b>Part No.</b>	416102	<b>Ref. No.</b>	270203150
<b>description</b>	heating element 3000W 240V heating circuits 1 L 249mm W 45mm H 265mm L1 17mm L2 232mm H1 50mm H2 180mm H3 35mm thread M12x1 tube $\varnothing$ 6.3mm connection M4 2 hole fixing fryer		
<b>accessories for</b>	416102		
	<b>Part No.</b>	520229	<b>Ref. No.</b> —
	nut thread M12x1 H 4mm WS 16 zinc-coated steel Qty 1 pcs		
	<b>Part No.</b>	521103	<b>Ref. No.</b> —
	nut thread M4 H 3mm WS 7 brass Qty 20 pcs		

<b>accessories for</b>	416102		
	<b>Part No.</b>	521104	<b>Ref. No.</b> —
	washer ID $\varnothing$ 4.3mm ED $\varnothing$ 8mm thickness 0.5mm brass Qty 20 pcs for thread M4		
	<b>Part No.</b>	521110	<b>Ref. No.</b> —
	flat gasket fibre ED $\varnothing$ 20mm ID $\varnothing$ 13mm thickness 2mm Qty 1 pcs		
	<b>Part No.</b>	521131	<b>Ref. No.</b> —
	nut thread M12x1 H 3.5mm WS 17 SS Qty 1 pcs		
	<b>Part No.</b>	528110	<b>Ref. No.</b> —
	O-ring EPDM thickness 2.62mm ID $\varnothing$ 12.37mm Qty 1 pcs		
	<b>Part No.</b>	560111	<b>Ref. No.</b> —
	plain washer ID $\varnothing$ 4.3mm ED $\varnothing$ 9mm thickness 0.8mm SS Qty 20 pcs DIN 125A for thread M4		
	<b>Part No.</b>	560131	<b>Ref. No.</b> —
	hexagonal nut thread M4 H 3.2mm WS 7 SS DIN/ISO DIN 934 / ISO 4032/8673 Qty 20 pcs		

<b>Part No.</b>	416103	<b>Ref. No.</b>	290200280
<b>description</b>	heating element 3000W 240V heating circuits 1 L 415mm W 43mm H 335mm L1 35mm L2 380mm H1 140mm H2 150mm H3 45mm thread M10 tube $\varnothing$ 6.3mm connection M4 2 hole fixing fryer		
<b>accessories for</b>	416103		
	<b>Part No.</b>	510416	<b>Ref. No.</b> —
	flat gasket fibre ED $\varnothing$ 19mm ID $\varnothing$ 10.5mm thickness 1.5mm for thread M10 Qty 1 pcs		
	<b>Part No.</b>	510893	<b>Ref. No.</b> —
	O-ring EPDM thickness 2.62mm ID $\varnothing$ 9.92mm Qty 1 pcs		
	<b>Part No.</b>	520231	<b>Ref. No.</b> —
	nut thread M10x1 H 6mm WS 14 zinc-coated steel Qty 1 pcs		
	<b>Part No.</b>	521129	<b>Ref. No.</b> —
	nut thread M10 H 6mm SS WS 17 Qty 1 pcs DIN/ISO DIN 439		



<b>Part No.</b>	416086	<b>Ref. No.</b>	270203790
<b>description</b>	heating element 3000W 230V heating circuits 1 L 210mm W 50mm H 230mm H1 162mm H2 68mm thread M12x1 tube ø 8.5mm windings 6 2 hole fixing connection M4 fryer		
<b>accessories for</b>	416086		
	<b>Part No.</b>	521103	<b>Ref. No.</b> —
	nut thread M4 H 3mm WS 7 brass Qty 20 pcs		
	<b>Part No.</b>	521104	<b>Ref. No.</b> —
	washer ID ø 4.3mm ED ø 8mm thickness 0.5mm brass Qty 20 pcs for thread M4		
	<b>Part No.</b>	560111	<b>Ref. No.</b> —
	plain washer ID ø 4.3mm ED ø 9mm thickness 0.8mm SS Qty 20 pcs DIN 125A for thread M4		
	<b>Part No.</b>	560131	<b>Ref. No.</b> —
	hexagonal nut thread M4 H 3.2mm WS 7 SS DIN/ISO DIN 934 / ISO 4032/8673 Qty 20 pcs		



<b>Part No.</b>	416085	<b>Ref. No.</b>	270204600
<b>description</b>	heating element 3000W 240V heating circuits 1 L 228mm W 50mm H 246mm H1 180mm H2 66mm thread 1/4" tube ø 8.5mm windings 5 2 hole fixing mounting distance 42mm connection M5 immersion heater		
<b>For models:</b>	500-701A, 700-701A-S, 700-702A-S, 900-701A-S, 900-702A-S		
<b>accessories for</b>	416085		
	<b>Part No.</b>	361182	<b>Ref. No.</b> —
	nut thread 1/4" H 5mm nickel-plated brass WS 17 Qty 1 pcs		
	<b>Part No.</b>	510417	<b>Ref. No.</b> —
	flat gasket fibre ED ø 20mm ID ø 14mm thickness 2mm Qty 1 pcs		
	<b>Part No.</b>	520228	<b>Ref. No.</b> —
	tooth lock washer ID ø 15.3mm ED ø 24mm steel Qty 1 pcs for thread M14		
	<b>Part No.</b>	550262	<b>Ref. No.</b> —
	flat gasket copper ED ø 20mm ID ø 14mm thickness 2mm		
	<b>Part No.</b>	560112	<b>Ref. No.</b> —
	plain washer ID ø 5.3mm ED ø 10mm thickness 1mm SS Qty 20 pcs DIN 125A for thread M5		
	<b>Part No.</b>	560132	<b>Ref. No.</b> —
	hexagonal nut thread M5 H 4mm WS 8 SS DIN/ISO DIN 934 / ISO 4032/8673 Qty 20 pcs		

<b>Part No.</b>	416083	<b>Ref. No.</b>	290203840
<b>description</b>	heating element 4500W 230V heating circuits 1 L 325mm W 50mm H 235mm H1 180mm H2 55mm thread M12x1 tube ø 8.5mm windings 6 2 hole fixing mounting distance 42mm connection M4 fryer		
<b>accessories for</b>	416083		
	<b>Part No.</b>	520229	<b>Ref. No.</b> —
	nut thread M12x1 H 4mm WS 16 zinc-coated steel Qty 1 pcs		
	<b>Part No.</b>	521103	<b>Ref. No.</b> —
	nut thread M4 H 3mm WS 7 brass Qty 20 pcs		
	<b>Part No.</b>	521104	<b>Ref. No.</b> —
	washer ID ø 4.3mm ED ø 8mm thickness 0.5mm brass Qty 20 pcs for thread M4		
	<b>Part No.</b>	521110	<b>Ref. No.</b> —
	flat gasket fibre ED ø 20mm ID ø 13mm thickness 2mm Qty 1 pcs		
	<b>Part No.</b>	521131	<b>Ref. No.</b> —
	nut thread M12x1 H 3.5mm WS 17 SS Qty 1 pcs		
	<b>Part No.</b>	528110	<b>Ref. No.</b> —
	O-ring EPDM thickness 2.62mm ID ø 12.37mm Qty 1 pcs		
	<b>Part No.</b>	560111	<b>Ref. No.</b> —
	plain washer ID ø 4.3mm ED ø 9mm thickness 0.8mm SS Qty 20 pcs DIN 125A for thread M4		
	<b>Part No.</b>	560131	<b>Ref. No.</b> —
	hexagonal nut thread M4 H 3.2mm WS 7 SS DIN/ISO DIN 934 / ISO 4032/8673 Qty 20 pcs		

<b>Part No.</b>	416117	<b>Ref. No.</b>	284203501 293202090
<b>description</b>	heating element 1700W 230V heating circuits 1 L 305mm W 45mm H 205mm L1 30mm L2 275mm H1 180mm H2 25mm thread M10x1 tube ø 6.5mm 2 hole fixing connection M4 immersion heater windings 3 fryer		
<b>spare parts for</b>	416117		
	<b>Part No.</b>	510416	<b>Ref. No.</b> —
	flat gasket fibre ED ø 19mm ID ø 10.5mm thickness 1.5mm for thread M10 Qty 1 pcs		

Table continues overleaf



accessories for 416117		Part No.	Ref. No.	
	O-ring EPDM thickness 2.62mm ID ø 9.92mm Qty 1 pcs	510893	—	—
	nut thread M10x1 H 6mm WS 14 zinc-coated steel Qty 1 pcs	520231	—	—
	nut thread M4 H 3mm WS 7 brass Qty 20 pcs	521103	—	—
	washer ID ø 4.3mm ED ø 8mm thickness 0.5mm brass Qty 20 pcs for thread M4	521104	—	—
	nut thread M10 H 6mm SS WS 17 Qty 1 pcs DIN/ISO DIN 439	521129	—	—
	plain washer ID ø 4.3mm ED ø 9mm thickness 0.8mm SS Qty 20 pcs DIN 125A for thread M4	560111	—	—
	hexagonal nut thread M4 H 3.2mm WS 7 SS DIN/ISO DIN 934 / ISO 4032/8673 Qty 20 pcs	560131	—	—

## heating elements for griddles

				
<b>Part No.</b>	416095	<b>Ref. No.</b>	260200020	
<b>description</b>	heating element 1100W 240V heating circuits 1 L 360mm W 82mm H 50mm tube ø 6.3mm L1 7mm W1 8mm W2 57mm connection M4 connection distance 76mm dry heating element			
<b>For models:</b>	64-320TL-TLC-TR, 64-322TL-TLC-TLR-TR			

				
<b>Part No.</b>	416096	<b>Ref. No.</b>	270200662	
<b>description</b>	heating element 1370W 240V heating circuits 1 L 430mm W 100mm H 60mm tube ø 6.3mm L1 10mm L2 420mm W1 10mm W2 80mm connection M4 connection length 26mm griddle dry heating element			

				
<b>Part No.</b>	416100	<b>Ref. No.</b>	290200112	
<b>description</b>	heating element 2020W 240V heating circuits 1 L 550mm W 100mm H 60mm tube ø 6.3mm L1 10mm L2 540mm W1 10mm W2 80mm connection M4 connection length 26mm griddle dry heating element			

## heating elements for large hobs

				
<b>Part No.</b>	416099	<b>Ref. No.</b>	211200550	
<b>description</b>	heating element 370W 57.5V heating circuits 1 L 340mm H 73mm tube ø 8.5mm connection distance 328mm connection male faston 6.3mm dry heating element			

				
<b>Part No.</b>	416097	<b>Ref. No.</b>	270204500	
<b>description</b>	heating element 450W 57.5V heating circuits 1 L 438mm H 72mm tube ø 8.5mm connection distance 428mm connection male faston 6.3mm dry heating element			

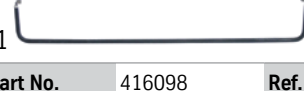
				
<b>Part No.</b>	416098	<b>Ref. No.</b>	290204040	
<b>description</b>	heating element 600W 230V heating circuits 1 L 580mm H 72mm tube ø 8.5mm connection distance 571mm connection male faston 6.3mm dry heating element			

## heating elements for tilting bratt pan

				
<b>Part No.</b>	416140	<b>Ref. No.</b>	290202450	
<b>description</b>	heating element 2300W 230V heating circuits 1 L 510mm W 90mm H 45mm connection distance 62mm tube ø 6.3mm dry heating element connection M4			





				
<b>Part No.</b>	416115	<b>Ref. No.</b>	241201401	
<b>description</b>	heating element 2400W 240V L 660mm W 120mm H 12mm connection male faston dry heating element heating circuits 1 tube ø 11mm			

				
<b>Part No.</b>	416114	<b>Ref. No.</b>	270200812	
<b>description</b>	heating element tilting bratt pan 2600W 230V L 375mm W 152mm H 58mm connection M4 dry heating element heating circuits 1 tube ø 8.5mm L1 25mm W2 100mm connection distance 88mm			
<b>For models:</b>	64-930T, 700-632, 700-930			

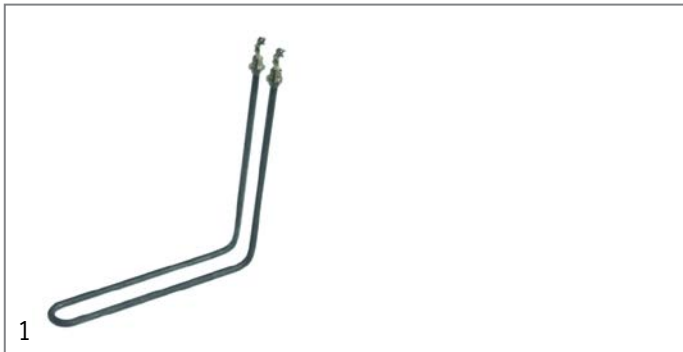

heating elements for pasta cookers







<b>Part No.</b>	416108	<b>Ref. No.</b>	260203010
<b>description</b>	heating element 1500W 240V L 245mm W 38mm H 237mm 2 hole fixing connection M4 thread M12x1 mounting distance 23mm pasta cooker		
<b>accessories for</b>	416108		
	<b>Part No.</b>	521103	<b>Ref. No.</b> —
	nut thread M4 H 3mm WS 7 brass Qty 20 pcs		
	<b>Part No.</b>	521104	<b>Ref. No.</b> —
	washer ID ø 4.3mm ED ø 8mm thickness 0.5mm brass Qty 20 pcs for thread M4		
	<b>Part No.</b>	560111	<b>Ref. No.</b> —
	plain washer ID ø 4.3mm ED ø 9mm thickness 0.8mm SS Qty 20 pcs DIN 125A for thread M4		
	<b>Part No.</b>	560131	<b>Ref. No.</b> —
	hexagonal nut thread M4 H 3.2mm WS 7 SS DIN/ISO DIN 934 / ISO 4032/8673 Qty 20 pcs		

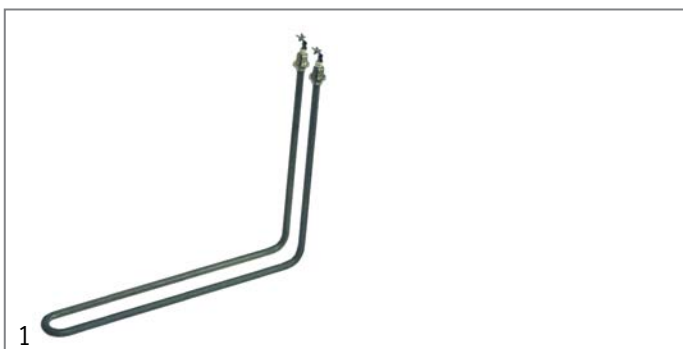





<b>Part No.</b>	420219	<b>Ref. No.</b>	270205870
<b>description</b>	heating element 1700W 230V heating circuits 1 L 310mm thread M16x1.5 tube ø 10mm mounting distance 40mm pasta cooker immersion heater		







<b>Part No.</b>	416110	<b>Ref. No.</b>	270203090
<b>description</b>	heating element 1900W 230V L 300mm W 37mm H 220mm 2 hole fixing connection M4 thread M12x1 mounting distance 25mm pasta cooker		
<b>accessories for</b>	416110		
	<b>Part No.</b>	521103	<b>Ref. No.</b> —
	nut thread M4 H 3mm WS 7 brass Qty 20 pcs		
	<b>Part No.</b>	521104	<b>Ref. No.</b> —
	washer ID ø 4.3mm ED ø 8mm thickness 0.5mm brass Qty 20 pcs for thread M4		
	<b>Part No.</b>	560111	<b>Ref. No.</b> —
	plain washer ID ø 4.3mm ED ø 9mm thickness 0.8mm SS Qty 20 pcs DIN 125A for thread M4		

<b>accessories for</b>	416110		
	<b>Part No.</b>	560131	<b>Ref. No.</b> —
	hexagonal nut thread M4 H 3.2mm WS 7 SS DIN/ISO DIN 934 / ISO 4032/8673 Qty 20 pcs		



<b>Part No.</b>	416109	<b>Ref. No.</b>	290203600
<b>description</b>	heating element 2600W 230V L 445mm W 50mm H 225mm 2 hole fixing connection M4 thread M12x1 mounting distance 42mm pasta cooker		
<b>accessories for</b>	416109		
	<b>Part No.</b>	521103	<b>Ref. No.</b> —
	nut thread M4 H 3mm WS 7 brass Qty 20 pcs		
	<b>Part No.</b>	521104	<b>Ref. No.</b> —
	washer ID ø 4.3mm ED ø 8mm thickness 0.5mm brass Qty 20 pcs for thread M4		
	<b>Part No.</b>	560111	<b>Ref. No.</b> —
	plain washer ID ø 4.3mm ED ø 9mm thickness 0.8mm SS Qty 20 pcs DIN 125A for thread M4		
	<b>Part No.</b>	560131	<b>Ref. No.</b> —
	hexagonal nut thread M4 H 3.2mm WS 7 SS DIN/ISO DIN 934 / ISO 4032/8673 Qty 20 pcs		



<b>Part No.</b>	416137	<b>Ref. No.</b>	270204220
<b>description</b>	heating element 2700W 230V heating circuits 1 L 300mm W 67mm H 2 hole fixing connection M4 thread M16x1.5 tube ø 8.5mm mounting distance 60mm pasta cooker immersion heater		
<b>accessories for</b>	416137		
	<b>Part No.</b>	521103	<b>Ref. No.</b> —
	nut thread M4 H 3mm WS 7 brass Qty 20 pcs		
	<b>Part No.</b>	521104	<b>Ref. No.</b> —
	washer ID ø 4.3mm ED ø 8mm thickness 0.5mm brass Qty 20 pcs for thread M4		
	<b>Part No.</b>	560111	<b>Ref. No.</b> —
	plain washer ID ø 4.3mm ED ø 9mm thickness 0.8mm SS Qty 20 pcs DIN 125A for thread M4		
	<b>Part No.</b>	560131	<b>Ref. No.</b> —
	hexagonal nut thread M4 H 3.2mm WS 7 SS DIN/ISO DIN 934 / ISO 4032/8673 Qty 20 pcs		

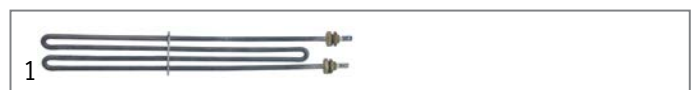





<b>Part No.</b>	416138	<b>Ref. No.</b>	290203880
<b>description</b>	heating element 4000W 230V heating circuits 1 L 485mm W 64mm 2 hole fixing connection M4 thread 3/8" tube ø 8.5mm mounting distance 56mm pasta cooker		
<b>accessories for</b>	416138		
	<b>Part No.</b>	521103	<b>Ref. No.</b> —
	nut thread M4 H 3mm WS 7 brass Qty 20 pcs		





Table continues overleaf



accessories for 416138			
	Part No.	521104	Ref. No. —
	washer ID $\varnothing$ 4.3mm ED $\varnothing$ 8mm thickness 0.5mm brass Qty 20 pcs for thread M4		
	Part No.	560111	Ref. No. —
	plain washer ID $\varnothing$ 4.3mm ED $\varnothing$ 9mm thickness 0.8mm SS Qty 20 pcs DIN 125A for thread M4		
	Part No.	560131	Ref. No. —
	hexagonal nut thread M4 H 3.2mm WS 7 SS DIN/ISO DIN 934 / ISO 4032/8673 Qty 20 pcs		

## heating elements for plate warmers



Part No.	416107	Ref. No.	241200562 A00084
description	heating element 1300W 240V 2 hole fixing thread M10x1 L 380mm W 100mm heating circuits 1 connection male faston 6.3mm L1 70mm L3 300mm dry heating element tube $\varnothing$ 6.5mm W1 29mm W2 42mm mounting distance 36mm heated cabinet		
For models:	ES-424NC, ES-828NC, ES-861NC, ES-891NC		
accessories for 416107			
	Part No.	510416	Ref. No. —
	flat gasket fibre ED $\varnothing$ 19mm ID $\varnothing$ 10.5mm thickness 1.5mm for thread M10 Qty 1 pcs		
	Part No.	510893	Ref. No. —
	O-ring EPDM thickness 2.62mm ID $\varnothing$ 9.92mm Qty 1 pcs		
	Part No.	520231	Ref. No. —
	nut thread M10x1 H 6mm WS 14 zinc-coated steel Qty 1 pcs		
	Part No.	521129	Ref. No. —
	nut thread M10 H 6mm SS WS 17 Qty 1 pcs DIN/ISO DIN 439		

## heating cables

## drain heating cables







Part No.	416338	Ref. No.	296201910
description	drain heating cable 55W 230V $\varnothing$ 6mm L 2500mm L1 (unheated) 500mm L2 (heated) 2000mm silicone connection terminal		

## pilot heating elements





Part No.	416113	Ref. No.	290202790
description	heating element 300W 240V heating circuits 1 mounting $\varnothing$ 47.5mm L 265mm W 31mm H 14mm round flange connection male faston 6.3mm immersion heater tube $\varnothing$ 6.3mm connection length 20mm thermostat sleeves $\varnothing$ 7.2mm length thermostat sleeves 246mm number of thermostat sleeves 1 thermostat sleeve clinging		
For models:	700-528, 900-523, 900-526, 920-523, 920-526		
accessories for 416113			
	Part No.	510408	Ref. No. —
	O-ring EPDM thickness 5.34mm ID $\varnothing$ 47mm Qty 1 pcs		

accessories for 416113			
	Part No.	510562	Ref. No. —
	O-ring silicone thickness 5.34mm ID $\varnothing$ 47mm Qty 1 pcs		
	Part No.	520235	Ref. No. —
	3 hole flange hole distance 70.5mm perforation $\varnothing$ 6.5mm ID $\varnothing$ 53.5mm		
	Part No.	520236	Ref. No. —
	flange for heating element ID $\varnothing$ 50mm ED $\varnothing$ 90mm hole $\varnothing$ 6.5mm 3 holes		
	Part No.	550002	Ref. No. —
	tension strap H 10mm L 21mm W 10mm hole $\varnothing$ 6.5mm for heating element		
	Part No.	550362	Ref. No. —
	blind flange $\varnothing$ 64mm mounting $\varnothing$ 47.5mm		

## immersion heating elements

3 hole flange  $\varnothing$ 47.5mm

Part No.	416139	Ref. No.	270203330
description	heating element 3000W 230V mounting $\varnothing$ 47.5mm heating circuits 3 L 362mm W 29mm H 35mm hole distance 62mm hole $\varnothing$ 8mm connection M4 3 hole flange immersion heater		
For models:	700-528		
spare parts for 416139			
	Part No.	510408	Ref. No. —
	O-ring EPDM thickness 5.34mm ID $\varnothing$ 47mm Qty 1 pcs		
accessories for 416139			
	Part No.	510562	Ref. No. —
	O-ring silicone thickness 5.34mm ID $\varnothing$ 47mm Qty 1 pcs		

3 hole flange  $\varnothing$ 57.5mm

Part No.	416126	Ref. No.	293200360
description	heating element 10500W 230V mounting $\varnothing$ 57.5mm heating circuits 3 L 590mm W 30mm H 40mm number of thermostat sleeves 1 thermostat sleeves $\varnothing$ 7mm length thermostat sleeves 480mm thermostat sleeve upper tube $\varnothing$ 8.5mm hole distance 73mm hole $\varnothing$ 10mm connection M4 3 hole flange immersion heater		
spare parts for 416126			
	Part No.	510409	Ref. No. —
	O-ring EPDM thickness 5.34mm ID $\varnothing$ 56.52mm Qty 1 pcs		

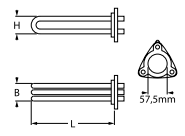

1

<b>Part No.</b>	416125	<b>Ref. No.</b>	293200760
<b>description</b>	heating element 7500W 230V mounting $\varnothing$ 57.5mm heating circuits 3 L 398mm W 36mm H 41mm number of thermostat sleeves 1 thermostat sleeves $\varnothing$ 7mm length thermostat sleeves 212mm thermostat sleeve not clinging tube $\varnothing$ 8.5mm hole distance 72mm hole $\varnothing$ 8mm connection M4 3 hole flange immersion heater		

with expansion flange 70 x 18mm



1

<b>Part No.</b>	417629	<b>Ref. No.</b>	260203110
<b>description</b>	heating element 1200W 230V heating circuits 1 flange 70x18mm L 320mm W 65mm tube $\varnothing$ 8.5mm thermostat sleeves $\varnothing$ 8mm length thermostat sleeves 180mm thermostat sleeve outer number of thermostat sleeves 1 TD $\varnothing$ 7mm		
<b>For models:</b>	64-500T, 64-542T		

with round flange  $\varnothing$ 60.0mm







1

<b>Part No.</b>	417573	<b>Ref. No.</b>	434008100 A00270
<b>description</b>	heating element 3990W 230V heating circuits 3 mounting $\varnothing$ 60mm L 320mm W 120mm H 40mm connection male faston 6.3mm tube $\varnothing$ 8.5mm		

1 1/2"



1

<b>Part No.</b>	416112	<b>Ref. No.</b>	A00149
<b>description</b>	heating element 4500W 230V heating circuits 3 thread 1 1/2" L 420mm W 25mm H 38mm tube $\varnothing$ 6.5mm connection M4 immersion heater flange with thread		
<b>For models:</b>	900-523, 920-523		
<b>spare parts for</b>	416112		
	<b>Part No.</b>	510406	<b>Ref. No.</b> —
	flat gasket fibre ED $\varnothing$ 60mm ID $\varnothing$ 48mm thickness 3mm for thread 1 1/2" Qty 1 pcs		
<b>accessories for</b>	416112		
	<b>Part No.</b>	510424	<b>Ref. No.</b> —
	gasket copper ED $\varnothing$ 55mm ID $\varnothing$ 48mm thickness 2.2mm Centellen for thread 1 1/2"		
	<b>Part No.</b>	520211	<b>Ref. No.</b> —
	reducer thread 2" ET - 1 1/2" IT brass		
	<b>Part No.</b>	520212	<b>Ref. No.</b> —
	hexagonal nut thread 1 1/2" brass WS 60 H 8mm		
	<b>Part No.</b>	550361	<b>Ref. No.</b> —
	blind flange $\varnothing$ 58mm thread 1 1/2"		

heating elements for convection



1

<b>Part No.</b>	416122	<b>Ref. No.</b>	293201430
<b>description</b>	heating element 10500W 230V heating circuits 3 ID $\varnothing$ 373mm ED $\varnothing$ 390mm L 124mm H 124mm L1 38mm W1 105mm H1 36mm H2 88mm flange length 142mm flange width 25mm hole distance 62mm connection M4 tube $\varnothing$ 8.5mm convection heating element hole $\varnothing$ 6mm rectangular flange		
<b>For models:</b>	EMD.E081MA, EMD.E081MN, EMD.E081MW		



1



<b>Part No.</b>	416123	<b>Ref. No.</b>	293200340
<b>description</b>	heating element 15000W 230V heating circuits 1 ID $\varnothing$ 428mm ED $\varnothing$ 443mm L 482mm H 158mm L1 27mm H1 32mm H2 123mm flange length 142mm flange width 25mm hole distance 63mm connection M6 connection length 71mm tube $\varnothing$ 8.5mm convection heating element hole $\varnothing$ 6mm rectangular flange		
<b>For models:</b>	EMD.E101MA, EMD.E101MN, EMD.E101MW		









1

<b>Part No.</b>	416118	<b>Ref. No.</b>	284203511 296201860
<b>description</b>	heating element 2000W 230V heating circuits 1 ID $\varnothing$ 180mm ED $\varnothing$ 192mm L 245mm H 34mm L1 45mm W1 32mm H1 10mm H2 24mm flange length 70mm flange width 22mm hole distance 56mm connection male faston 6.3mm connection length 60mm tube $\varnothing$ 6.3mm convection heating element mounting thread M5 rectangular flange with thread bolt		
<b>For models:</b>	9ES-122N, 9ES-152N, 9ES-182N, ES-121NVC, ES-151NVC, ES-181NVC		



			
1			
<b>Part No.</b>	416119	<b>Ref. No.</b>	238200212
<b>description</b>	heating element 2000W 240V heating circuits 1 ID $\varnothing$ 182mm ED $\varnothing$ 195mm L 245mm H 34mm L1 43mm W1 30mm H1 10mm H2 24mm flange length 70mm flange width 22mm hole distance 56mm connection male faston 6.3mm tube $\varnothing$ 6.3mm convection heating element mounting thread M5 rectangular flange with thread bolt		
<b>accessories for</b>	416119		
	<b>Part No.</b>	510368	<b>Ref. No.</b> —
	gasket L 70mm W 23.5mm hole $\varnothing$ 5mm hole distance 56mm FIBER thickness 2mm for heating element		

			
1			
<b>Part No.</b>	416120	<b>Ref. No.</b>	284201560
<b>description</b>	heating element 2800W 240V heating circuits 1 ID $\varnothing$ 185mm ED $\varnothing$ 198mm L 245mm H 34mm L1 42mm W1 30mm H1 12mm H2 22mm flange length 70mm flange width 22mm hole distance 56mm connection male faston 6.3mm tube $\varnothing$ 6.3mm convection heating element mounting thread M5 rectangular flange with thread bolt		
<b>For models:</b>	64-040FCE, 64-050FCE, 64-222FCE		
<b>accessories for</b>	416120		
	<b>Part No.</b>	510368	<b>Ref. No.</b> —
	gasket L 70mm W 23.5mm hole $\varnothing$ 5mm hole distance 56mm FIBER thickness 2mm for heating element		



			
1			
<b>Part No.</b>	416124	<b>Ref. No.</b>	293201010
<b>description</b>	heating element 4000W 230V heating circuits 1 ID $\varnothing$ 465mm ED $\varnothing$ 482mm L 655mm L1 160mm H 17mm thread M14x1.5 connection M4 2 hole fixing tube $\varnothing$ 8.5mm convection heating element		
<b>For models:</b>	EMD.E102MA, EMD.E102MN		
<b>accessories for</b>	416124		
	<b>Part No.</b>	510417	<b>Ref. No.</b> —
	flat gasket fibre ED $\varnothing$ 20mm ID $\varnothing$ 14mm thickness 2mm Qty 1 pcs		
	<b>Part No.</b>	520228	<b>Ref. No.</b> —
	tooth lock washer ID $\varnothing$ 15.3mm ED $\varnothing$ 24mm steel Qty 1 pcs for thread M14		
	<b>Part No.</b>	520230	<b>Ref. No.</b> —
	nut thread M14x1.5 H 5mm WS 19 zinc-coated steel Qty 1 pcs		
	<b>Part No.</b>	521101	<b>Ref. No.</b> —
	nut thread M14x1.5 H 5mm WS 19 SS Qty 1 pcs		

<b>accessories for</b>	416124		
	<b>Part No.</b>	550262	<b>Ref. No.</b> —
	flat gasket copper ED $\varnothing$ 20mm ID $\varnothing$ 14mm thickness 2mm		

			
1			
<b>Part No.</b>	416121	<b>Ref. No.</b>	293200380
<b>description</b>	heating element 7500W 230V heating circuits 3 ID $\varnothing$ 315mm ED $\varnothing$ 332mm L 370mm H 101mm L1 25mm W1 105mm H1 14mm H2 87mm flange length 143mm flange width 26mm hole distance 63mm connection M4 tube $\varnothing$ 8.5mm convection heating element hole $\varnothing$ 6mm rectangular flange		
<b>For models:</b>	EMD.E061MA, EMD.E061MN, EMD.E061MW		

## radiation heaters

			
1			
<b>Part No.</b>	490153	<b>Ref. No.</b>	292200520
<b>description</b>	radiation heater octagonal 3400W 230V L 300mm W 300mm heating circuits 2 H 30mm with heating coil energy regulation with temperature signalization connections 4+2 connection type cable cable length 900mm AD		

			
1			
<b>Part No.</b>	490159	<b>Ref. No.</b>	511062335
<b>description</b>	radiation heater L 300mm W 300mm 3500W 230V connections 3 square without pan detection EGO		
<b>For models:</b>	110-037A-T, 110-057A-T, 110-057FE, 920-037A-T, 920-057A-T, 920-057FE		
<b>spare parts for</b>	490159		
	<b>Part No.</b>	499157	<b>Ref. No.</b> —
	protection pipe for temperature probe ceramic L 297mm ED $\varnothing$ 7mm ID $\varnothing$ 5mm		







			
1			
<b>Part No.</b>	419079	<b>Ref. No.</b>	270204020
<b>description</b>	radiation heater L 330mm W 330mm 2100W 230V heating circuits 1 H 35mm square without pan detection IRCA		

square (others)

			
1			
<b>Part No.</b>	490192	<b>Ref. No.</b>	270205010 770124250
<b>description</b>	radiation heater L 335mm W 310mm 6000W 400V H 45mm		
<b>For models:</b>	500-755A, 700-755A-S, 700-855A-S		

			
1			
<b>Part No.</b>	419074	<b>Ref. No.</b>	290204520
<b>description</b>	radiation heater rectangular 5000W 400V L 605mm W 240mm heating circuits 3		
<b>For models:</b>	900-320AL-ALC, 900-320AR, 900-320CL-CLC-CR, 900-320TL-TLC-TR, 920-032A-T, 920-320AL-ALC-AR, 920-320TL-TLC-TR		

1-circuit

			
1			
<b>Part No.</b>	490025	<b>Ref. No.</b>	511062317
<b>description</b>	radiation heater ø 200mm 1700W 230V heating circuits 1 energy regulation with temperature signalization with heating coil connections 2+2 connection type male faston 6.3mm EGO		
<b>For models:</b>	64-037T, 64-057FE, 64-057T, 700-037A-T, 700-057A-T, 700-057FEB		

			
1			
<b>Part No.</b>	490113	<b>Ref. No.</b>	260203260
<b>description</b>	radiation heater ø 200mm 1800W 230V heating circuits 1 energy regulation with temperature signalization with ribbon heater connections 2+2 connection type male faston 6.3mm CERAMASPEED		

			
1			
<b>Part No.</b>	490150	<b>Ref. No.</b>	270120320 511062325
<b>description</b>	radiation heater ø 250mm 2500W 230V heating circuits 1 energy regulation with temperature signalization with heating coil connections 2+2 connection type male faston 6.3mm EGO		
<b>For models:</b>	700-037A-T, 700-057A-T, 700-057FEB, 900-037A-T, 900-057A-T, 900-057FE		

2-circuit

			
1			
<b>Part No.</b>	490114	<b>Ref. No.</b>	270204030
<b>description</b>	radiation heater ø 230mm 2200W 230V heating circuits 2 energy regulation with temperature signalization partial power 750W with ribbon heater connections 2+2 connection type male faston 6.3mm CERAMASPEED		

hot plates

square & rectangular

with radiused edge

			
1			
<b>Part No.</b>	490073	<b>Ref. No.</b>	5110003
<b>description</b>	hot plate dimensions 300x300mm 3000W 400V with spill ring connection 4 screw clamps protector no square		
<b>For models:</b>	110-030A-T, 110-050A-T, 110-050FE, 500-050A-T, 500-050FE, 900-030A-C-T, 900-050A-C-T, 900-050FE, 900-172A-C-T, 900-172FEA, 920-030A-T, 920-050A-T, 920-050FE, 920-172A-T, 920-172FEA		

1

<b>Part No.</b>	490071 <sup>1</sup>	<b>Ref. No.</b>	511012440
<b>description</b>	hot plate dimensions 300x300mm 4000W 230V with spill ring connection 4 screw clamps protector yes square		

<sup>1</sup>incl. protector

## round

with radiused edge

for domestic and commercial kitchens



1

<b>Part No.</b>	490010	<b>Ref. No.</b>	611062410
<b>description</b>	hot plate ø 145mm 1000W 230V connection 4 screw clamps with 8mm spill ring		
<b>For models:</b>	64-030T, 64-050FCE, 64-050FE-FEV, 64-050T		



1

<b>Part No.</b>	490014	<b>Ref. No.</b>	611062415
<b>description</b>	hot plate ø 180mm 1500W 230V connection 4 screw clamps with 8mm spill ring		
<b>For models:</b>	64-030T, 64-050FCE, 64-050FE-FEV, 64-050T		



1

<b>Part No.</b>	490020	<b>Ref. No.</b>	511022426
<b>description</b>	hot plate ø 220mm 2600W 230V connection 4 screw clamps with 8mm spill ring		
<b>accessories for</b>	490020		
	<b>Part No.</b>	<b>Ref. No.</b>	—
	550796		
	fixing plate for hot plate ø220mm		

## energy regulators

### EGO

#### 1-circuit



1

<b>Part No.</b>	380015	<b>Ref. No.</b>	539209
<b>description</b>	energy regulator 230V 13A single-circuit turn direction right shaft ø 6x4.6mm shaft L 23mm mounting thread M4 power release 6-100% no. 50.57021.010		



1

<b>Part No.</b>	380019	<b>Ref. No.</b>	539205
<b>description</b>	energy regulator 240V 13A single-circuit turn direction right shaft ø 6x4.6mm shaft L 23mm mounting thread M4 power release 6-100% no. 50.57071.010		
<b>For models:</b>	70-820, 70-840, ES-702N, ES-IR090C-I, ES-IR120C-I, ES-IR150C-I, ESIR180C-I		

#### 2-circuit



1

<b>Part No.</b>	380027	<b>Ref. No.</b>	539206 539207 539208
<b>description</b>	energy regulator EGO 230V 13A dual circuit turn direction right shaft ø 6x4.6mm shaft L 23mm mounting thread M4 power release 6-70% no. 50.55021.100		
<b>For models:</b>	AB-370080A, AB-370080W, AB-370801A, AB-370801W, AB-96080A, AB-96080W, AB-96801A, AB-96801W, AB-96802A, AB-96802W, ABAB03A, AB-AB03FA, AB-AB03PA, AB-AB03W, AB-AB05A, AB-AB05PA, AB-AB05W, AB-AB10A, AB-AB10PA, AB-AB10PW, AB-AB10W, ABAB14A, AB-AB14PA, AB-AB14PW, AB-AB14W		



# thermostats

## control and safety thermostats

EGO

control thermostats

55.10/19\_ series



<b>Part No.</b>	375238	<b>Ref. No.</b>	53401030110
<b>description</b>	thermostat t.max. 110°C temperature range 33-110°C 1-pole 1CO 16A probe ø 6mm probe L 138mm capillary pipe 880mm capillary pipe isolated 870mm gland nut shaft ø 6x4.6mm shaft L 23mm shaft position upper rotation 270°		

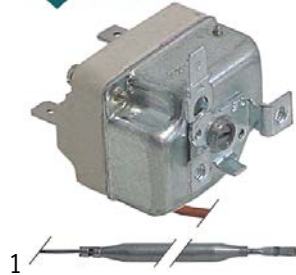

<b>Part No.</b>	375229	<b>Ref. No.</b>	53400112150
<b>description</b>	thermostat t.max. 150°C temperature range fixed 150°C 1-pole 1CO 16A probe ø 6mm probe L 130mm capillary pipe 900mm capillary pipe isolated 700mm gland nut shaft Lmm shaft position		
<b>For models:</b>	700-528, 900-523, 900-526, 920-523, 920-526		

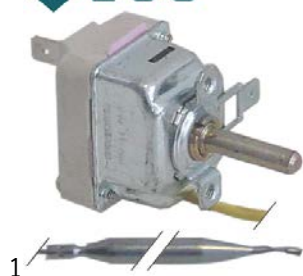

<b>Part No.</b>	375367	<b>Ref. No.</b>	5340101
<b>description</b>	thermostat t.max. 182°C temperature range 93-180°C 1-pole 1NO 16A probe ø 6mm probe L 133mm capillary pipe 2020mm capillary pipe isolated 1800mm gland nut shaft ø 6x4.6mm shaft L 23mm shaft position upper rotation 270°		
<b>For models:</b>	500-701A, 64-700T, 64-703T, 700-609A, 700-701A-S, 700-702A-S, 700-704A-S, 700-705A-S, 700-708A-S, 900-609A, 900-701A-S, 900-702A-S, 900-704A-S, 900-705A-S, 900-706A-S, 920-609A, 920-704A-S		

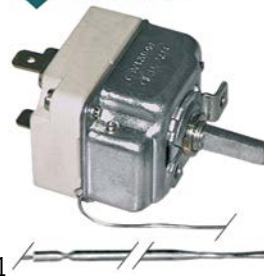

<b>Part No.</b>	375216	<b>Ref. No.</b>	53401005270
<b>description</b>	thermostat t.max. 280°C temperature range 50-280°C 1-pole 1NO 16A probe ø 3mm probe L 228mm capillary pipe 1300mm capillary pipe isolated 1150mm gland nut shaft L 23mm shaft position upper rotation 318°		
<b>For models:</b>	500-050FE, 64-040FCE, 64-040FE, 64-050FE-FEV, 64-050T, 64-057FE, 64-222FCE, 64-222FE, 700-040FEB, 700-050FEB, 700-052FEB, 700-054FEB, 700-055FEB, 700-057FEB, 700-138FEBA, 700-162FEBA, 700-200FEB, 700-222FEB, 700-224FEBA, 700-411B, 900-652, 900-950, 920-652, 920-950, EMD.E061MA, EMD.E061MN, EMD.E061MW, EMD.E081MA, EMD.E081MN, EMD.E081MW, EMD.E101MA, EMD.E101MN, EMD.E101MW, EMD.E102MA, EMD.E102MN		

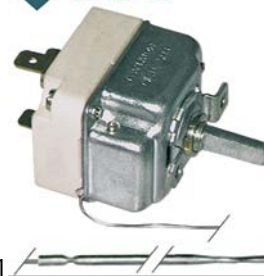

<b>Part No.</b>	375232	<b>Ref. No.</b>	53401005320
<b>description</b>	thermostat t.max. 320°C temperature range 55-320°C 1-pole capillary pipe isolatedmm gland nut		
<b>For models:</b>	110-500A-T, 64-930T, 700-500A-C-T, 700-542A-C-T, 700-622, 700-632, 700-900, 700-930, 900-500A-C-T, 900-542A-C-T, 900-622, 900-632, 900-642, 900-900, 900-930, 900-940, 920-500A-T, 920-542A-T, 920-622, 920-632, 920-642, 920-900, 920-930, 920-940		



<b>Part No.</b>	375360	<b>Ref. No.</b>	6340000005503
<b>description</b>	thermostat t.max. 55°C temperature range fixed 55°C 1CO 16A probe ø 6mm probe L 130mm capillary pipe 900mm capillary pipe isolated 900mm gland nut		



## 55.34\_ series



<b>Part No.</b>	375303	<b>Ref. No.</b>	53401031820
<b>description</b>	thermostat t.max. 185°C temperature range 95-185°C 3-pole 3NO 156A probe ø 6mm probe L 131mm capillary pipe 1470mm capillary pipe isolated 1100mm gland nut		

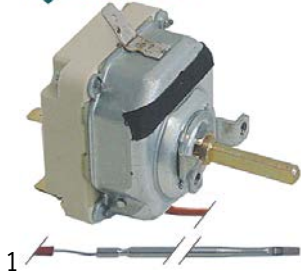

<b>Part No.</b>	375230	<b>Ref. No.</b>	53403050390
<b>description</b>	thermostat t.max. 270°C temperature range 55-270°C 3-pole 3NO 16A probe ø 3mm probe L 219mm capillary pipe 900mm capillary pipe isolated 900mm gland nut shaft ø 6x4.6mm shaft L 23mm shaft position upper rotation 270°		
<b>For models:</b>	110-050FE, 110-052FE, 110-057FE, 110-122FELC, 110-122FEL-FELR, 110-200FE, 500-320AL-ALC-AR, 500-320TL-TLC-TR, 500-322AL-ALCALR-AR, 500-322TL-TLC-TLR-TR, 700-320AL-ALC-AR, 700-320CL-CLCCR, 700-320TL-TLC-TR, 700-322AL-ALC-ALR-AR, 700-322CL-CLCCLR-CR, 700-322TL-TLC-TLR-TR, 700-960A-D, 700-962A, 900-040FE, 900-050FE, 900-052FE, 900-054FE, 900-057FE, 900-138FEA, 900-162FEA, 900-172FEA, 900-182FE, 900-200FE, 900-320AL-ALC, 900-320CL-CLC-CR, 900-320TL-TLC-TR, 900-411-413, 900-960A, 900-962A, 920-050FE, 920-052FE, 920-057FE, 920-122FELC, 920-122FELFELR-FER, 920-122FELR, 920-122FER, 920-172FEA, 920-200FE		



<b>Part No.</b>	375192	<b>Ref. No.</b>	00402 53402705320
<b>description</b>	thermostat t.max. 300°C temperature range 50-300°C 3-pole 3NO 16A probe ø 3mm probe L 219mm capillary pipe 900mm capillary pipe isolatedmm gland nut shaft ø 6x4.6mm shaft L 23mm shaft position upper rotation 270°		



<b>Part No.</b>	375412	<b>Ref. No.</b>	53403050300
<b>description</b>	thermostat t.max. 320°C temperature range 50-320°C 3-pole 3NO 16A probe ø 3.1mm probe L 226mm capillary pipe 1480mm capillary pipe isolated 1400mm gland nut shaft ø 6x4.6mm shaft L 23mm shaft position upper rotation 318°		
<b>For models:</b>	64-320TL-TLC-TR, 64-322TL-TLC-TLR-TR, 9ES-122N, 9ES-122NG, 9ES-152N, 9ES-152NG, 9ES-182N, 9ES-182NG		

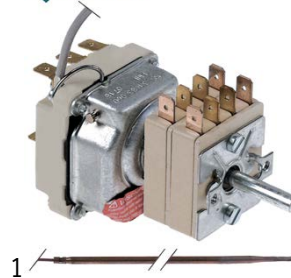

<b>Part No.</b>	375917	<b>Ref. No.</b>	53403085550
<b>description</b>	thermostat t.max. 550°C temperature range 85-500/85-550°C 3-pole 2NO/1NO 16A probe ø 3.9mm probe L 228mm capillary pipe 1110mm capillary pipe isolated 600mm gland nut shaft ø 6x4.6mm shaft L 23mm rotation 318° outer switch 2NO/2NO		

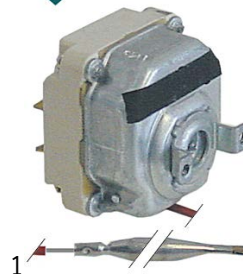

<b>Part No.</b>	375361	<b>Ref. No.</b>	6340007509002
<b>description</b>	thermostat t.max. 90°C temperature range fixed 75/90°C 2-pole 2CO 16A probe ø 6mm probe L 130mm capillary pipe 900mm capillary pipe isolated 900mm gland nut		





<b>Part No.</b>	375411	<b>Ref. No.</b>	53403003090
<b>description</b>	thermostat t.max. 93°C temperature range 30-93°C 3-pole 3NO 16A probe ø 6mm probe L 129mm capillary pipe 1480mm capillary pipe isolated 1100mm gland nut M10x1 shaft ø 6x4.6mm shaft L 23mm shaft position upper rotation 270°		
<b>For models:</b>	9ES-122N, 9ES-122NG, 9ES-152N, 9ES-152NG, 9ES-182N, 9ES-182NG		



<b>Part No.</b>	375371	<b>Ref. No.</b>	53400112220
<b>description</b>	safety thermostat switch-off temp. 225°C 1-pole 1NC probe ø 6mm probe L 86mm capillary pipe 2020mm capillary pipe isolated 1770mm gland nut probe SS		
<b>For models:</b>	500-701A, 64-700T, 64-703T, 700-701A-S, 700-702A-S, 700-704A-S, 700-705A-S, 700-708A-S, 900-701A-S, 900-702A-S, 900-704A-S, 900-705A-S, 900-706A-S, 920-704A-S, 9ES-122N, 9ES-152N, 9ES-182N, ES-121NVC, ES-151NVC, ES-181NVC		



safety thermostats

55.10/19\_ series



<b>Part No.</b>	375373	<b>Ref. No.</b>	63401053230
<b>description</b>	safety thermostat capillary pipe 900mm probe ø 11mm 1-pole probe L 26mm 0.5A capillary pipe isolated 700mm gland nut switch-off temp. 230°C probe screw-in probe probe thread M14x1		



<b>Part No.</b>	375166	<b>Ref. No.</b>	5340101230	
<b>description</b>	safety thermostat switch-off temp. 230°C 1-pole 0.5A probe ø 11mm probe L 16.5mm capillary pipe 850mm capillary pipe isolated 850mm gland nut probe screw-in probe probe thread M14x1			
<b>accessories for</b>	375166			
	<b>Part No.</b>	521133	<b>Ref. No.</b>	—
	nut thread M14x1.5 H 6mm WS 19 zinc-coated steel Qty 1 pcs			
	<b>Part No.</b>	532520	<b>Ref. No.</b>	—
	O-ring silicone thickness 2.62mm ID ø 15.08mm Qty 1 pcs			
	<b>Part No.</b>	550261	<b>Ref. No.</b>	—
	nut thread M14x1 H 4mm WS 19 SS Qty 1 pcs			



<b>Part No.</b>	375218	<b>Ref. No.</b>	6340004014500
<b>description</b>	safety thermostat switch-off temp. 145°C 1-pole 16A probe ø 6mm probe L 130mm capillary pipe 900mm capillary pipe isolated 900mm gland nut probe SS		



<b>Part No.</b>	375227	<b>Ref. No.</b>	5340011200
<b>description</b>	safety thermostat switch-off temp. 238°C 1-pole 0.5A probe ø 4mm probe L 116mm capillary pipe 900mm capillary pipe isolated 700mm gland nut M9x1 probe SS		
<b>For models:</b>	500-601A, 64-600T-603T, 64-755T, 700-508, 700-601A-S, 700-602A-S, 700-603A, 700-604A-605A, 700-609A, 900-503, 900-506, 900-601A-S, 900-602A-S, 900-604A-S, 900-605A-S, 900-609A, 920-503, 920-506, 920-604A-S, 920-609A		



## 55.32\_ series

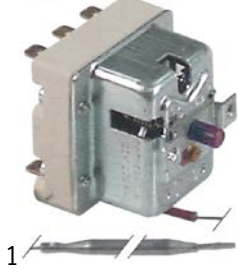

<b>Part No.</b>	375369	<b>Ref. No.</b>	53403000120
<b>description</b>	safety thermostat switch-off temp. 120°C 3-pole 0.5A probe ø 6mm probe L 94mm capillary pipe 890mm capillary pipe isolatedmm gland nut probe SS		
<b>For models:</b>	64-500T, 64-542T		

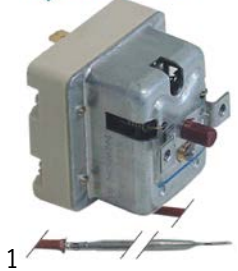

<b>Part No.</b>	375226	<b>Ref. No.</b>	53403000340
<b>description</b>	safety thermostat switch-off temp. 340°C 1-pole 0.5A probe ø 3mm probe L 190mm capillary pipe 900mm capillary pipe isolated 900mm gland nut probe SS		
<b>For models:</b>	110-122ALC, 110-122FELC, 110-122FLC, 500-120ALC, 500-120TLC, 500-122ALC, 500-122TLC, 64-120TLC, 64-122TLC, 700-120ALC-CLC, 700-120TLC, 700-122ALC, 700-122CLC, 700-122TLC, 900-120ALC, 900-120CLC-TLC, 900-122ALC-CLC-TLC, 920-120ALC, 920-120TLC, 920-122ALC, 920-122FELC, 920-122FLC, 920-122TLC		



<b>Part No.</b>	375228	<b>Ref. No.</b>	53403000350
<b>description</b>	safety thermostat switch-off temp. 350°C 3-pole 20A probe ø 3mm probe L 188mm capillary pipe 900mm capillary pipe isolated 900mm gland nut probe SS		
<b>For models:</b>	110-050FE, 110-052FE, 110-057FE, 110-122FELC, 110-122FEL-FELR, 110-200FE, 500-050FE, 500-320AL-ALC-AR, 500-320TL-TLC-TR, 500-322AL-ALC-ALR-AR, 500-322TL-TLC-TLR-TR, 64-320TL-TLC-TR, 64-322TL-TLC-TLR-TR, 64-930T, 700-040FEB, 700-050FEB, 700-052FEB, 700-054FEB, 700-055FEB, 700-057FEB, 700-138FEBA, 700-162FEBA, 700-200FEB, 700-222FEB, 700-224FEBA, 700-320AL-ALC-AR, 700-320CL-CLC-CR, 700-320TL-TLC-TR, 700-322AL-ALC-ALR-AR, 700-322CL-CLC-CLR-CR, 700-322TL-TLC-TLR-TR, 700-411B, 700-622, 700-632, 700-900, 700-930, 700-960A-D, 700-962A, 900-040FE, 900-050FE, 900-052FE, 900-054FE, 900-057FE, 900-138FEA, 900-162FEA, 900-172FEA, 900-182FE, 900-200FE, 900-320AL-ALC, 900-320CL-CLCCR...(Other models you can see in the webshop)		

## 56.\_ series



<b>Part No.</b>	375987	<b>Ref. No.</b>	63400040320 6340004032001
<b>description</b>	safety thermostat switch-off temp. 335°C 1-pole 20A probe ø 3.03mm probe L 160mm capillary pipe 900mm capillary pipe isolated 750mm gland nut probe SS		
<b>For models:</b>	64-040FCE, 64-050FCE, 64-222FCE		

## control thermostats with operation switch

## 55.34\_ series

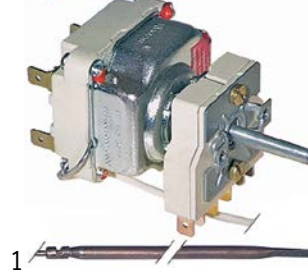

<b>Part No.</b>	375246	<b>Ref. No.</b>	53401100615
<b>description</b>	thermostat t.max. 645°C temperature range 100-615/645°C 2-pole 2NO 16A probe ø 4mm probe L 230mm capillary pipe 1100mm capillary pipe isolated 600mm gland nut shaft ø 6x4.6mm shaft L 25mm shaft position lower rotation 270° outer switch 2NO probe material copper		

## accessories

## plunger sockets





<b>Part No.</b>	550469	<b>Ref. No.</b>	A00431
<b>description</b>	thermowell thread 3/4" ID ø 4mm L 230mm SS/brass double		
<b>For models:</b>	500-601A, 64-600T-603T, 700-601A-S, 700-602A-S, 700-603A, 700-604A-605A, 900-601A-S, 900-602A-S, 900-604A-S, 900-605A-S, 920-604A-S		

<b>accessories for</b>	550469	<b>Part No.</b>	510403	<b>Ref. No.</b>	—
		flat gasket fibre ED ø 36.5mm ID ø 27mm thickness 2mm Qty 1 pcs			
		<b>Part No.</b>	510421	<b>Ref. No.</b>	—
		gasket copper ED ø 31.8mm ID ø 26.4mm thickness 2.2mm for thread 3/4"			
		<b>Part No.</b>	520234	<b>Ref. No.</b>	—
		nut thread 3/4" H 5mm brass WS 30 Qty 1 pcs			



connecting bows

 <p>1</p>			
<b>Part No.</b>	550060	<b>Ref. No.</b>	5200995
<b>description</b>	connecting bow long for thermostat Qty 1 pcs		
<b>For models:</b>	110-032A-T, 110-050FE, 110-052A, 110-052FE, 110-052T, 110-057FE, 110-122FELC, 110-122FEL-FELR, 110-200FE, 110-320AL ALR, 110-320TL-TLR, 110-322AL-ALC-ALR, 110-322FEL-FELC-FELR, 110-322TL-TLC-TLR, 500-320AL-ALC-AR, 500-320TL-TLC-TR, 500-322AL-ALC-ALR-AR, 500-322TL-TLC-TLR-TR, 64-320TL-TLC-TR, 64-322TL-TLC-TLR-TR, 700-052A-C-T, 700-052FEB, 700-054A, 700-054C, 700-054FEB, 700-054T, 700-320AL-ALC-AR, 700-320CL-CLC-CR, 700-320TL-TLC-TR, 700-322AL-ALC-ALR-AR, 700-322CL-CLC-CLR-CR, 900-052A-C-T, 900-052FE, 900-054A-C-T, 900-054FE, 900-057FE, 900-138FEA, 900-162FEA, 900-172FEA, 900-182FE, 900-200FE, 900-320ALALC, 900-320AR, 900-320CL-CLC-CR, 900-320TL-TLC-TR... (Other models you can see in the webshop)		

 <p>1</p>			
<b>Part No.</b>	345643	<b>Ref. No.</b>	A00413
<b>description</b>	push switch mounting ø 25mm clear 1NO/indicator light 250V 16A reset connection male faston 6.3mm ambient temperature max. 85°C protection IP40		

 <p>1</p>			
<b>Part No.</b>	345392	<b>Ref. No.</b>	A00285
<b>description</b>	push switch mounting ø 25mm orange 2NO 250V 16A illuminated core temperature connection male faston 6.3mm ambient temperature max. 85°C protection IP40		

switches and momentary switches

push/momentary push switches



<p>ø25mm</p>  <p>1</p>			
<b>Part No.</b>	300155	<b>Ref. No.</b>	A00252 A00252neu
<b>description</b>	momentary push switch mounting ø 25mm black 2NO 250V 16A light connection male faston 6.3mm ambient temperature max. 85°C protection IP40		

 <p>1</p>			
<b>Part No.</b>	300154	<b>Ref. No.</b>	A00255 A00256
<b>description</b>	push switch mounting ø 25mm orange 2NO/indicator light 250V 16A illuminated fan connection male faston 6.3mm ambient temperature max. 85°C protection IP40		

 <p>1</p>			
<b>Part No.</b>	300156	<b>Ref. No.</b>	A00253
<b>description</b>	push switch mounting ø 25mm red 250V 16A voltage connection male faston 6.3mm ambient temperature max. 85°C protection IP40		

 <p>1</p>			
<b>Part No.</b>	345642	<b>Ref. No.</b>	A00292
<b>description</b>	push switch mounting ø 25mm red 1NO/indicator light 250V 16A water connection male faston 6.3mm ambient temperature max. 85°C protection IP40		
<b>For models:</b>	700-622, 700-632, 700-900, 700-930, 900-622, 900-632, 900-642, 900-652, 900-900, 900-930, 900-940, 900-950, 920-622, 920-632, 920-642, 920-652, 920-900, 920-930, 920-940, 920-950		

 <p>1</p>			
<b>Part No.</b>	300169	<b>Ref. No.</b>	52280116380
<b>description</b>	push switch mounting ø 25mm clear 1NO 250V 16A connection male faston 6.3mm ambient temperature max. 85°C protection IP40		

 <p>1</p>			
<b>Part No.</b>	345039	<b>Ref. No.</b>	55463001
<b>description</b>	protective cover round ED ø 33mm external size 23mm internal size 21mm H 12mm clear mounting ø 25mm		
<b>For models:</b>	500-701A, 64-519T, 64-520T, 700-519A-C-T, 700-520T, 700-622, 700-632, 700-900, 700-930, 900-622, 900-632, 900-642, 900-652, 900-900, 900-930, 900-940, 900-950, 920-622, 920-632, 920-642, 920-652, 920-900, 920-930, 920-940, 920-950		
<b>accessories for</b>	345039		
	<b>Part No.</b>	345001	<b>Ref. No.</b>
	 <p>momentary push switch mounting ø 25mm yellow 1NO/indicator light 250V 16A cover connection male faston 6.3mm ambient temperature max. 85°C protection IP65</p>		

 <p>1</p>			
<b>Part No.</b>	300161 <sup>1</sup>	<b>Ref. No.</b>	5209201 6209201
<b>description</b>	push switch mounting ø 25mm white 2NO/indicator light 250V 16A illuminated connection male faston 6.3mm ambient temperature max. 85°C protection IP40		
<b>For models:</b>	110-500A-T, 500-500A, 500-701A, 64-500T, 64-519T, 64-520T, 64-542T, 700-520T		

<sup>1</sup>illuminated





## microswitches

## lever actuated



1

<b>Part No.</b>	345773	<b>Ref. No.</b>	63952511
<b>description</b>	microswitch with lever 250V 16A 1CO connection male faston 6.3mm L 60mm ambient temperature max. 125°C mounting distance 22mm actuating force: 65g lever length 51mm		
<b>For models:</b>	AF6-1202B, AF6-1202M, AF6-1203B, AF6-1203M, AF6-1204B, AF6-1204M, AF6-1402B, AF6-1402M, AF6-1402MB, AF6-1402MM, AF6-1403B, AF6-1403M, AF6-1403MB, AF6-1404B, AF6-1404M, AF6-1404MM, AF6-601B-701B, AF6-601M, AF6-601MV, AF6-602B-702B, AF6-602M, AF6-701M, AF6-701MV, AF6-701P, AF6-702M, AF6-702MB, AF6-702MM, AF7-1402B, AF7-1402M, AF7-1402MB, AF7-1402MM, AF7-1403B, AF7-1403M, AF7-1403MB, AF7-1404B, AF7-1404M, AF7-1404MM, AF7-701B, AF7-701M, AF7-701P, AF7-702B, AF7-702M, AF7-702MB, AF7-702MM		



1

<b>Part No.</b>	300152	<b>Ref. No.</b>	784106510
<b>description</b>	microswitch with lever CO connection male faston		



1

<b>Part No.</b>	300158	<b>Ref. No.</b>	539504neu 790107730
<b>description</b>	microswitch with lever 250V 8A 1CO connection cable L 31mm L1 76mm ambient temperature max. 85°C mounting distance 22mm type 831690 actuating force: 300g protection IP67		

## pin-plunger actuated

## M10



1

<b>Part No.</b>	345032	<b>Ref. No.</b>	522583131
<b>description</b>	microswitch with plunger thread M10x1 thread L 12mm 250V 16A 1CO connection male faston 6.3mm stroke 7mm mounting distance 22mm L 28mm ambient temperature max. 125°C type SP9603 actuating force: 180g		

## cam switches

## on/off



1

<b>Part No.</b>	300102	<b>Ref. No.</b>	539502
<b>description</b>	cam switch 4 operating positions 4NO sequence 0-1-0-1 32A shaft ø 6x4.6mm shaft L 23mm connection screw ceramic		
<b>For models:</b>	500-701A, 64-700T, 64-703T, 64-930T, 700-701A-S, 700-702A-S, 700-704A-S, 700-705A-S, 700-708A-S, 900-701A-S, 900-702A-S, 900-704AS, 900-705A-S, 900-706A-S, 920-704A-S		

## 4-position



1

<b>Part No.</b>	300103	<b>Ref. No.</b>	00410 52002432
<b>description</b>	cam switch 4 operating positions 1NO/2CO sequence 0-1-2-3 32A shaft ø 6x4.6mm shaft L 23mm connection screw ceramic		
<b>For models:</b>	110-030A-T, 110-050A-T, 110-050FE, 500-030A-T, 500-050A-T, 500-050FE, 700-035A-C-T, 700-055A-C-T, 700-055FEB, 900-030A-C-T, 900-050A-C-T, 900-050FE, 900-172A-C-T, 900-172FEA, 900-521-522, 900-821, 920-030A-T, 920-050A-T, 920-050FE, 920-172A-T, 920-172FEA		



1



<b>Part No.</b>	300104	<b>Ref. No.</b>	52003432
<b>description</b>	cam switch 4 operating positions 3NO/1CO sequence 0-1-2-3 32A shaft ø 6x4.6mm shaft L 23mm connection screw ceramic		
<b>For models:</b>	64-755T, 700-528, 900-523, 900-526, 920-523, 920-526		



7-position



1

<b>Part No.</b>	300025	<b>Ref. No.</b>	52002715
<b>description</b>	cam switch 7 operating positions 1NO/2CO sequence 0-1-2-3-4-5-6 16A shaft $\varnothing$ 6x4.6mm shaft L 23mm connection screw 7-position ceramic		
<b>For models:</b>	64-030T, 64-050FCE, 64-050FE-FEV, 64-050T, 700-030A-C-T		
<b>accessories for</b>	300025		
	<b>Part No.</b>	112172	<b>Ref. No.</b> —
	knob universal $\varnothing$ 70mm black without adaptor/dial plate		
	<b>Part No.</b>	112213	<b>Ref. No.</b> —
	knob dial plate silver switch 7-position t.max.°C ED $\varnothing$ 63mm ID $\varnothing$ 45.5mm		
	<b>Part No.</b>	112311	<b>Ref. No.</b> —
	knob adapter shaft $\varnothing$ 6x4.6mm L 0mm with spring		

operation switches



1

<b>Part No.</b>	300080	<b>Ref. No.</b>	00423 52004115
<b>description</b>	cam switch 2 operating positions 4NO 16A sequence 0-1 shaft $\varnothing$ 6x4.6mm shaft L 23mm connection screw operation switch ceramic ambient temperature max. 150°C		
<b>For models:</b>	110-032A-T, 110-050FE, 110-052A, 110-052FE, 110-052T, 110-057FE, 110-122FELC, 110-122FEL-FELR, 110-200FE, 110-320AL ALR, 110-320TL-TLR, 110-322AL-ALC-ALR, 110-322FEL-FELC-FELR, 110-322TL-TLC-TLR, 500-320AL-ALC-AR, 500-320TL-TLC-TR, 500-322AL-ALC-ALR-AR, 500-322TL-TLC-TLR-TR, 64-320TL-TLC-TR, 64-322TL-TLC-TLR-TR, 700-052A-C-T, 700-052FEB, 700-054A, 700-054C, 700-054FEB, 700-054T, 700-320AL-ALC-AR, 700-320CL-CLC-CR, 700-320TL-TLC-TR, 700-322AL-ALC-ALR-AR, 700-322CL-CLC-CLR-CR, 700-322TL-TLC-TLR-TR, 700-960A-D, 700-962A, 900-040FE, 900-050FE, 900-052A-C-T, 900-052FE, 900-054A-C-T, 900-054FE, 900-057FE, 900-138FEA, 900-162FEA, 900-172FEA, 900-182FE, 900-200FE, 900-320ALALC, 900-320AR, 900-320CL-CLC-CR, 900-320TL-TLC-TR... (Other models you can see in the webshop)		
<b>accessories for</b>	300080		
	<b>Part No.</b>	551456	<b>Ref. No.</b> —
	gasket for switch ED $\varnothing$ 14mm ID $\varnothing$ 2.5mm thickness 3.5mm white		

4 operating positions



1

<b>Part No.</b>	300010	<b>Ref. No.</b>	620044924
<b>description</b>	cam switch 4 operating positions 2NO/2CO sequence 0-1-2-3 16A shaft $\varnothing$ 6x4.6mm shaft L 23mm connection male faston 6.3mm ceramic		



1

<b>Part No.</b>	300107	<b>Ref. No.</b>	52004132
<b>description</b>	cam switch 2 operating positions operation switch 32A sequence 0-1 shaft $\varnothing$ 6x4.6mm shaft L 23mm connection screw ceramic		

5 operating positions

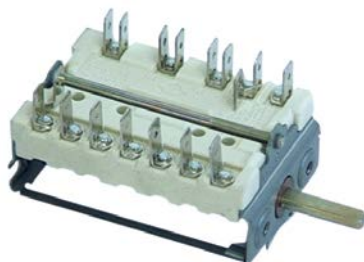

1

<b>Part No.</b>	300162	<b>Ref. No.</b>	62051824
<b>description</b>	cam switch 5 operating positions shaft $\varnothing$ 6x4.6mm connection male faston 7-pole		
<b>For models:</b>	EMD.E061MN, EMD.E081MN, EMD.E101MN, EMD.E102MN		



1

<b>Part No.</b>	300200	<b>Ref. No.</b>	52002115
<b>description</b>	operation switch 2 operating positions 2NO 16A sequence 0-1 shaft ø 6x4.6mm shaft L 23mm connection male faston 6.3mm operation switch ceramic		
<b>For models:</b>	500-050FE, 500-755A, 64-519T, 64-520T, 64-700T, 64-703T, 64-930T, 700-040FEB, 700-050FEB, 700-052FEB, 700-054FEB, 700-055FEB, 700-057FEB, 700-138FEBA, 700-162FEBA, 700-200FEB, 700-222FEB, 700-224FEBA, 700-411B, 700-519A-C-T, 700-520T, 700-701A-S, 700-702A-S, 700-704A-S, 700-705A-S, 700-708A-S, 700-755A-S, 700-855A-S, 900-701A-S, 900-702A-S, 900-704A-S, 900-705A-S, 900-706A-S, 900-755A-S, 900-855A-S, 920-704A-S, 920-755A-S, EMD.E061MA, EMD.E061MW, EMD.E081MA, EMD.E081MW, EMD.E101MA, EMD.E101MW, EMD.E102MA, ES-023N, ES-121NVC, ES-151NVC, ES-181NVC		

## magnetic switches

40x13mm



1

<b>Part No.</b>	300150	<b>Ref. No.</b>	695001
<b>description</b>	magnetic switch L 40mm W 13mm 250V 0.04A connection cable		
<b>For models:</b>	AB-370080A, AB-370080W, AB-370801A, AB-370801W, AB-96080A, AB-96080W, AB-96801A, AB-96801W, AB-96802A, AB-96802W, AB-AB03A, AB-AB03FA, AB-AB03PA, AB-AB03W, AB-AB05A, AB-AB-05PA, AB-AB05W, AB-AB10A, AB-AB10PA, AB-AB10PW, AB-AB10W, AB-AB14A, AB-AB14PA, AB-AB14PW, AB-AB14W, EMD.E061MA, EMD.E061MN, EMD.E061MW, EMD.E081MA, EMD.E081MN, EMD.E081MW, EMD.E101MA, EMD.E101MN, EMD.E101MW, EMD.E102MA, EMD.E102MN		

## control equipment

## GENERAL ELECTRIC (AEG)

## push buttons



1

<b>Part No.</b>	300168	<b>Ref. No.</b>	52210001
<b>description</b>	push button mounting measurements ø22mm black		

## switches (complete)



1

<b>Part No.</b>	345644	<b>Ref. No.</b>	A00411
<b>description</b>	momentary push switch mounting measurements ø22mm 1NC/1NO		
<b>For models:</b>	700-622, 700-632, 900-622, 900-632, 900-642, 900-652, 920-622, 920-632, 920-642, 920-652		



1

<b>Part No.</b>	300165	<b>Ref. No.</b>	A00128
<b>description</b>	mushroom switch mounting measurements ø22mm complete		



1

<b>Part No.</b>	300163	<b>Ref. No.</b>	A00126
<b>description</b>	push switch mounting measurements ø22mm complete		

## lamps

## indicator lights

## indicator light lenses

ø10mm (type SRZ-3)



1



<b>Part No.</b>	359123	<b>Ref. No.</b>	6229044
<b>description</b>	indicator light housings mounting measurements ø10mm green round Qty 1 pcs		
<b>accessories for</b>	359123		
<b>Part No.</b>	359132	<b>Ref. No.</b>	6229046
<b>description</b>	indicator lamp green 250V connection male faston 6.3mm protection IP54 ambient temperature max. 85°C		





1

<b>Part No.</b>	359125	<b>Ref. No.</b>	6229047
<b>description</b>	indicator light housings mounting measurements ø10mm red round Qty 1 pcs		









			
1			
<b>Part No.</b>	359124	<b>Ref. No.</b>	6229043
<b>description</b>	indicator light housings mounting measurements ø10mm yellow round Qty 1 pcs		
<b>For models:</b>	64-755T		
<b>accessories for</b>	359124		
			
<b>Part No.</b>	359132	<b>Ref. No.</b>	6229046
<b>description</b>	indicator lamp green 250V connection male faston 6.3mm protection IP54 ambient temperature max. 85°C		

indicator lamps for socket type SRZ / SDK / SDY / SFK			
			
1			
<b>Part No.</b>	359132	<b>Ref. No.</b>	6229046
<b>description</b>	indicator lamp green 250V connection male faston 6.3mm protection IP54 ambient temperature max. 85°C		
<b>For models:</b>	64-755T		

indicator lights (complete)			
ø10mm			
with plug-in socket			
			
1			
<b>Part No.</b>	359139	<b>Ref. No.</b>	A00409
<b>description</b>	indicator light ø 10mm green 230V connection male faston 6.3mm Qty 1 pcs		
<b>For models:</b>	110-030A-T, 110-032A-T, 110-037A-T, 110-050A-T, 110-050FE, 110-052A, 110-052FE, 110-052T, 110-057A-T, 110-057FE, 110-122FELC, 110-122FEL-FELR, 110-200FE, 110-320AL-ALR, 110-320TL-TLR, 110-322AL-ALC-ALR, 110-322FEL-FELC-FELR, 110-322TL-TLC-TLR, 110-500A-T, 500-030A-T, 500-050A-T, 500-050FE, 500-320AL-ALC-AR, 500-320TL-TLC-TR, 500-322AL-ALC-ALR-AR, 500-322TL-TLC-TLR-TR, 500-701A, 500-755A, 64-030T, 64-037T, 64-040FCE, 64-050FCE, 64-050FE-FEV, 64-050T, 64-057FE, 64-057T, 64-222FCE, 64-320TL-TLC-TR, 64-322TL-TLC-TLR-TR, 64-519T, 64-520T, 64-700T, 64-703T, 64-930T, 700-030A-C-T, 700-035A-C-T, 700-037A-T, 700-040FEB, 700-050FEB, 700-052A-C-T...(Other models you can see in the webshop)		

			
1			
<b>Part No.</b>	359140	<b>Ref. No.</b>	A00410
<b>description</b>	indicator light ø 10mm yellow 230V connection male faston 6.3mm Qty 1 pcs		
<b>For models:</b>	110-032A-T, 110-050FE, 110-052A, 110-052FE, 110-052T, 110-057FE, 110-122FELC, 110-122FEL-FELR, 110-200FE, 110-320AL-ALR, 110-320TL-TLR, 110-322AL-ALC-ALR, 110-322FEL-FELC-FELR, 110-322TL-TLC-TLR, 110-500A-T, 500-050FE, 500-320AL-ALC-AR, 500-320TL-TLC-TR, 500-322AL-ALC-ALR-AR, 500-322TL-TLC-TLR-TR, 500-500A, 500-755A, 64-040FCE, 64-040FE, 64-050FCE, 64-050FE-FEV, 64-057FE, 64-222FCE, 64-222FE, 64-320TL-TLC-TR, 64-322TL-TLC-TLR-TR, 64-500T, 64-519T, 64-520T, 64-542T, 64-700T, 64-703T, 64-930T, 700-040FEB, 700-050FEB, 700-052A-C-T, 700-052FEB, 700-054A, 700-054C, 700-054FEB, 700-054T, 700-055FEB, 700-057FEB, 700-138FEBA, 700-162FEBA...(Other models you can see in the webshop)		

ø13mm			
with screw socket			
			
1			
<b>Part No.</b>	359049	<b>Ref. No.</b>	5229054
<b>description</b>	indicator light ø 13mm 400V green		
<b>For models:</b>	70-820, 70-840, 9ES-122N, 9ES-122NG, 9ES-152N, 9ES-152NG, 9ES-182N, 9ES-182NG, ES-023N, ES-121NVC, ES-121NVC, ES-121NVC, ES-151NVC, ES-151NVC, ES-181NVC, ES-181NVC, ES-702N, ES-IR090C-I, ESIR120C-I, ES-IR150C-I, ES-IR180C-I		
<b>accessories for</b>	359049		
			
<b>Part No.</b>	510302	<b>Ref. No.</b>	—
<b>description</b>	O-ring EPDM ID ø 12.42mm thickness 1.78mm Qty 1 pcs		
			
<b>Part No.</b>	511505	<b>Ref. No.</b>	—
<b>description</b>	O-ring EPDM thickness 1.78mm ID ø 12.42mm Qty 10 pcs		

			
1			
<b>Part No.</b>	359050	<b>Ref. No.</b>	5229052
<b>description</b>	indicator light ø 13mm 400V yellow		
<b>For models:</b>	9ES-122N, 9ES-122NG, 9ES-152N, 9ES-152NG, 9ES-182N, 9ES-182NG, ES-023N, ES-121NVC, ES-121NVC, ES-121NVC, ES-151NVC, ES-151NVC, ES-181NVC, ES-181NVC, ES-424NC, ES-702N, ES-828NC, ES-861NC, ES-891NC		
<b>accessories for</b>	359050		
			
<b>Part No.</b>	510302	<b>Ref. No.</b>	—
<b>description</b>	O-ring EPDM ID ø 12.42mm thickness 1.78mm Qty 1 pcs		
			
<b>Part No.</b>	511505	<b>Ref. No.</b>	—
<b>description</b>	O-ring EPDM thickness 1.78mm ID ø 12.42mm Qty 10 pcs		

screw-on/push-on fit			
halogen lamp			
for socket G4 / G6.35 / G9			
			
1			
<b>Part No.</b>	357193	<b>Ref. No.</b>	6242122001
<b>description</b>	halogen lamp socket G4 12V 20W temp.-resist. 300°C OSRAM HALOSTAR OVEN		

			
1			
<b>Part No.</b>	359599	<b>Ref. No.</b>	6242122001
<b>description</b>	halogen lamp socket G4 12V 20W temp.-resist. 500°C		



## linear lamps

## infrared lamps

## with base type R7s



<b>Part No.</b>	359628	<b>Ref. No.</b>	5190001
<b>description</b>	infrared lamp socket R7s L 117.6mm 240V 300W IMPORT unjacketed		

## oven lamps



## universal oven lamps

## mounting diameter 35.5mm



<b>Part No.</b>	359718	<b>Ref. No.</b>	6230001
<b>description</b>	oven lamp mounting $\varnothing$ 35.5mm 230V 15W socket E14 temp.-resist. 300°C connection male faston 6.3mm hard glas		

## spare parts for

	<b>Part No.</b>	359701	<b>Ref. No.</b>	—
	lamp socket socket E14 220-230V mounting $\varnothing$ 35.5mm connection male faston 6.3mm 15W			
	<b>Part No.</b>	359740	<b>Ref. No.</b>	—
	light bulb t.max. 300°C socket E14 15W 230V $\varnothing$ 22mm L 48mm lens L 20mm for oven lamp IMPORT			

## lamps

## halogen lamps

## for socket G4 / G6.35 / G9



<b>Part No.</b>	357193	<b>Ref. No.</b>	6242122001
<b>description</b>	halogen lamp socket G4 12V 20W temp.-resist. 300°C OSRAM HALOSTAR OVEN		



<b>Part No.</b>	359599	<b>Ref. No.</b>	6242122001
<b>description</b>	halogen lamp socket G4 12V 20W temp.-resist. 500°C		

## residual heat indicators



<b>Part No.</b>	359095	<b>Ref. No.</b>	260204050
<b>description</b>	residual heat indicator 4-fold		



<b>Part No.</b>	359096	<b>Ref. No.</b>	260203270
<b>description</b>	residual heat indicator single		

## timers

## programme timers



<b>Part No.</b>	360332	<b>Ref. No.</b>	6352000	
<b>description</b>	timer FIBER P25 engines 1 chambers 1 operation time 60s 230V shaft $\varnothing$ mm shaft Lmm manuf. no. P255J01H191 motor type M51BJ0R6400			
<b>spare parts for</b>	360332			
	<b>Part No.</b>	360673	<b>Ref. No.</b>	—
	motor kit pinion $\varnothing$ 6.8mm teeth 15 230V voltage AC 50/60Hz turn direction clockwise motor $\varnothing$ 48mm H 18.5mm motor type UDS-40NE1RNZ165 cable length 150mm with holder			

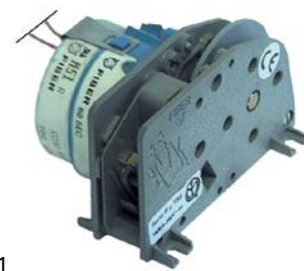



<b>Part No.</b>	350046	<b>Ref. No.</b>	6352000	
<b>description</b>	timer FIBER P25 engines 1 chambers 1 operation time 60s shaft $\varnothing$ mm shaft Lmm			
<b>spare parts for</b>	350046			
	<b>Part No.</b>	360673	<b>Ref. No.</b>	—
	motor kit pinion $\varnothing$ 6.8mm teeth 15 230V voltage AC 50/60Hz turn direction clockwise motor $\varnothing$ 48mm H 18.5mm motor type UDS-40NE1RNZ165 cable length 150mm with holder			

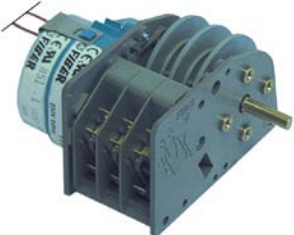

1

<b>Part No.</b>	350045	<b>Ref. No.</b>	6352001
<b>description</b>	timer FIBER P25 engines 1 chambers 3 operation time 1h 230V shaft ø 6x4.6mm shaft L 20mm manuf. no. P255J03W195 motor type M51BJ0L6400		
<b>spare parts for</b>	350045		
	<b>Part No.</b>	360674	<b>Ref. No.</b> —
	motor kit pinion ø 6.8mm teeth 15 230V voltage AC 50/60Hz turn direction counterclockwise motor ø 48mm H 18.5mm motor type UDS40NE1RNZ165 cable length 150mm with holder		



1

<b>Part No.</b>	350008	<b>Ref. No.</b>	6351120
<b>description</b>	timer M2 with bell 2-pole operation time 120min impulse mechanical 2NO at 250V 16A permanent position yes shaft ø 6x4.6mm shaft 6x4.6mm shaft L 24mm mounting distance 28mm connection lateral		
<b>For models:</b>	64-040FCE, 64-050FCE, 64-222FCE		

electric timers

with time spread



1

<b>Part No.</b>	350074	<b>Ref. No.</b>	293202310
<b>description</b>	timer MS65 operation time 120min time spread 30min 1CO/2NO/1NC at 250V 16A permanent position yes impulse electric shaft ø 6x4.6mm shaft L 22mm mounting distance 28mm connection lateral Invensys 4-pole shaft position lower*		

mechanical timers



1

<b>Part No.</b>	350003	<b>Ref. No.</b>	63510120
<b>description</b>	timer M2 with bell 2-pole operation time 120min impulse mechanical 2NO at 250V 16A permanent position no shaft ø 6x4.6mm shaft 6x4.6mm shaft L 23mm mounting distance 28mm connection lateral		
<b>accessories for</b>	350003		
	<b>Part No.</b>	110366	<b>Ref. No.</b> —
	knob switch zero mark t.max. °C ø 44mm shaft ø 6x4.6mm shaft flat upper black		
	<b>Part No.</b>	111199	<b>Ref. No.</b> —
	dial plate graduation 120min permanent position no rotation 0-330° ø 60mm timers knob ø 45mm		

alarm devices

alarm units



1

<b>Part No.</b>	350056	<b>Ref. No.</b>	623002
<b>description</b>	alarm device 220-240VAC ømm H 25mm wall-mounted version mounting distancemm 83dB protection IPx0		
<b>For models:</b>	EMD.E061MA, EMD.E081MA, EMD.E101MA, EMD.E102MA		

contactors

LOVATO

power contactors



1

<b>Part No.</b>	380084	<b>Ref. No.</b>	5300016
<b>description</b>	power contactor 230VAC		
<b>For models:</b>	700-528, 700-632, 700-930, 70-820, 900-523, 900-526, 900-632, 900-652, 900-930, 900-950, 920-523, 920-526, 920-632, 920-652, 920-930, 920-950		



1

<b>Part No.</b>	380086	<b>Ref. No.</b>	63002406
<b>description</b>	power contactor resistive load 16A 230VAC (AC3/400V) 5A/2.2kW main contacts 3NO auxiliary contacts 1NC connection screw connection type 11BG0601A230 manuf. no. 11BG0601A230		
<b>For models:</b>	EMD.E061MA, EMD.E061MN, EMD.E061MW, EMD.E081MA, EMD.E081MN, EMD.E081MW, EMD.E101MA, EMD.E101MN, EMD.E101MW, EMD.E102MA, EMD.E102MN		



			
1			
<b>Part No.</b>	380087	<b>Ref. No.</b>	6300240600
<b>description</b>	power contactor resistive load 16A 230VAC (AC3/400V) 5A/2.2kW main contacts 3NO auxiliary contacts 1NO connection screw connection type 11BG0610A230		

			
1			
<b>Part No.</b>	380082	<b>Ref. No.</b>	53002420904
<b>description</b>	power contactor resistive load 20A 240VAC (AC3/400V) 9A/4kW main contacts 4NO		
<b>For models:</b>	110-500A-T, 500-701A, 64-700T, 64-703T, 64-755T, 64-930T, 700-325A-326A, 700-500A-C-T, 700-542A-C-T, 700-708A-S, 70-840, 900-325A-326A, 900-500A-C-T, 900-542A-C-T, 900-706A- S, 920-500AT, 920-542A-T		

			
1			
<b>Part No.</b>	380083	<b>Ref. No.</b>	530024501
<b>description</b>	power contactor resistive load 25A 230VAC (AC3/400V) 9A/4.2kW main contacts 3NO auxiliary contacts 1NC connection screw connection type BF0901A230		
<b>For models:</b>	500-755A, 700-701A-S, 700-702A-S, 700-704A-S, 700-705A-S, 700-755A-S, 700-855A-S, 900-701A-S, 900-702A-S, 900-704A-S, 900-705AS, 900-755A-S, 900-855A-S, 920-704A-S, 920-755A-S, AB-370080A, AB-370080W, AB-370801A, AB-370801W, AB-96080A, AB-96080W, AB-96801A, AB-96801W, AB-96802A, AB-96802W, AB- AB03A, AB-AB-03FA, AB-AB03PA, AB-AB03W, AB-AB05A, AB-AB05PA, AB-AB05W, ABAB10A, AB-AB10PA, AB-AB10PW, AB-AB10W, AB-AB14A, AB-AB14PA, AB-AB14PW, AB-AB14W, EMD.E061MA, EMD.E061MN, EMD.E061MW, EMD.E081MA, EMD.E081MN, EMD.E081MW, EMD.E101MA, EMD.E101MN, EMD.E101MW, EMD.E102MA...(Other models you can see in the webshop)		

## miscellaneous

## power contactors

1			
<b>Part No.</b>	380085	<b>Ref. No.</b>	5300240600
<b>description</b>	power contactor		
<b>For models:</b>	700-622, 700-632, 900-622, 900-632, 900-642, 900-652, 920-622, 920-632, 920-642, 920-652, EMD.E061MA, EMD.E061MN, EMD.E061MW, EMD.E081MA, EMD.E081MN, EMD.E081MW, EMD.E101MA, EMD.E101MN, EMD.E101MW, EMD.E102MA, EMD.E102MN, TR-G2341BN, TR-G234BN, TR-N2341BN, TR-N2342BN, TR-N234BN		

## relays

## level relays

GICAR			
			
1			
<b>Part No.</b>	400018	<b>Ref. No.</b>	639624051
<b>description</b>	level relay 230V voltage AC connection F6.3 type RL30/3ES/F/G		

## time relays

## time relays

			
1			
<b>Part No.</b>	380075	<b>Ref. No.</b>	53601030 6320000
<b>description</b>	time relay LOVATO TM P time range 0.1s-240h 24-240VAC/ 24-48VDC 8A 1CO connection screw clamp		
<b>For models:</b>	EMD.E061MA, EMD.E061MW, EMD.E081MA, EMD.E081MW, EMD.E101MA, EMD.E101MW, EMD.E102MA		





## transformers

### toroidal core transformers

			
1			
<b>Part No.</b>	401618	<b>Ref. No.</b>	293203880
<b>description</b>	transformer primary 230V secondary 12V 50VA		
<b>For models:</b>	EMD.E061MA, EMD.E061MN, EMD.E061MW, EMD.E081MA, EMD.E081MW, EMD.E101MA, EMD.E101MW, EMD.E102MA		

### encapsulated transformers

PMA			
			
1			
<b>Part No.</b>	379054	<b>Ref. No.</b>	639603
<b>description</b>	transformer primary 230VAC secondary 12VAC 3VA secondary 0.25A H 40mm L 45mm W 50mm connection screw 50/60Hz type 153/M		

### for lighting

			
1			
<b>Part No.</b>	400095	<b>Ref. No.</b>	639602
<b>description</b>	electrical ballast primary 230V secondary 11.5V 45VA		

			
1			
<b>Part No.</b>	400668	<b>Ref. No.</b>	639601
<b>description</b>	transformer primary 230V secondary 12V 20VA		

## electronic controllers

### EVCO - EVERY CONTROL

#### universal controllers

#### built-in version

			
1			
<b>Part No.</b>	378131	<b>Ref. No.</b>	629601
<b>description</b>	electronic controller EVERY CONTROL EVK411M mounting measurements 71x29mm 12V voltage AC/DC NTC/PTC/Pt100/Pt1000 relay outputs 1 CO-16A(8) NTC/PTC/Pt100/Pt1000/TC(J,K)/mV/mA yes protection IP65 dependent on probe°C display 3½ digits		
<b>accessories for</b>	378131		
	<b>Part No.</b>	379050	<b>Ref. No.</b> —
	temperature probe Pt100 cable Vetrotex probe -200 up to +600°C cable -50 up to +350°C probe ø6x100mm cable length 2.7m without screw connection 3-wire		
	<b>Part No.</b>	379160	<b>Ref. No.</b> —
	temperature probe NTC 10kOhm cable thermoplastic probe -40 up to +110°C cable -40 up to +110°C probe ø6x14mm cable length 1.5m without screw connection 2-wire		
	<b>Part No.</b>	379781	<b>Ref. No.</b> —
	temperature probe PTC 1kOhm cable thermoplastic probe -50 up to +150°C cable -40 up to +110°C probe ø6x14mm cable length 1.5m without screw connection 2-wire		
	<b>Part No.</b>	379944	<b>Ref. No.</b> —
	temperature probe Pt1000 cable Vetrotex probe -70 up to +500°C cable -50 up to +350°C connection 2-wire thread probe ø6x180mm cable length 1.7m		

### SHANGFANG

#### accessories

			
1			
<b>Part No.</b>	379054	<b>Ref. No.</b>	639603
<b>description</b>	transformer primary 230VAC secondary 12VAC 3VA secondary 0.25A H 40mm L 45mm W 50mm connection screw 50/60Hz type 153/M		



## probes

### producer-specific probes

#### probes



1			
<b>Part No.</b>	400261	<b>Ref. No.</b>	62771000 A00317
<b>description</b>	temperature probe Pt100 cable Vetrotex probe -100 up to 450°C cable -50 up to +350°C connection 3-wire thread probe ø6x80mm cable length 1m		



1			
<b>Part No.</b>	400719	<b>Ref. No.</b>	540201
<b>description</b>	temperature probe thread probe ø4x50mm		

#### core probes



1			
<b>Part No.</b>	400263	<b>Ref. No.</b>	6277041000
<b>description</b>	core temperature probe Pt100 cable PTFE probe -40 up to +250°C cable -40 up to +250°C connection 2-wire probe ø4x100mm thread cable length 2m handle ø 10mm handle length 90mm		

## electronics

### PCBs



1			
<b>Part No.</b>	400200	<b>Ref. No.</b>	292200640
<b>description</b>	PCB		



1			
<b>Part No.</b>	401451	<b>Ref. No.</b>	292200620
<b>description</b>	PCB pyroceram range 110/920 series		

1			
<b>Part No.</b>	401397	<b>Ref. No.</b>	A00301
<b>description</b>	PCB replace set		



1			
<b>Part No.</b>	400281	<b>Ref. No.</b>	66210001
<b>description</b>	programming PCB		



1			
<b>Part No.</b>	400282	<b>Ref. No.</b>	66210002
<b>description</b>	relay PCB		

## keypads

### front foils



1			
<b>Part No.</b>	400272	<b>Ref. No.</b>	293200920
<b>description</b>	front foil		

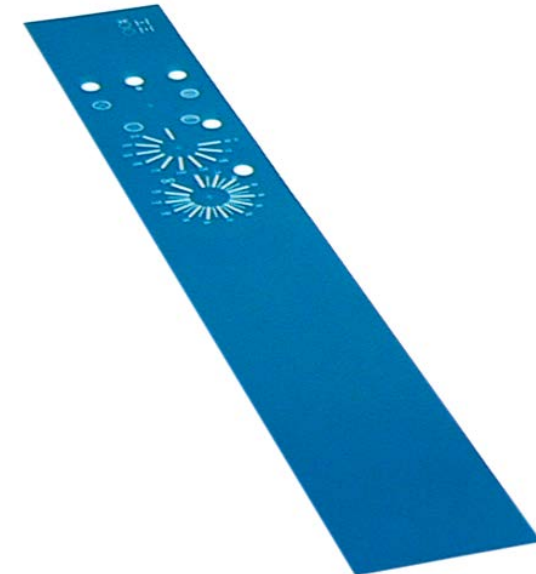

1			
<b>Part No.</b>	400273	<b>Ref. No.</b>	293201850
<b>description</b>	front foil		

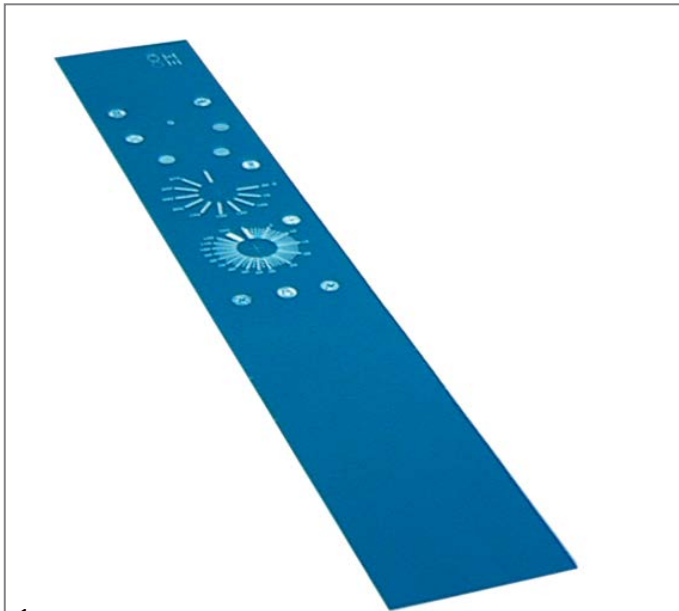

1

<b>Part No.</b>	400274	<b>Ref. No.</b>	293200220
<b>description</b>	front foil		

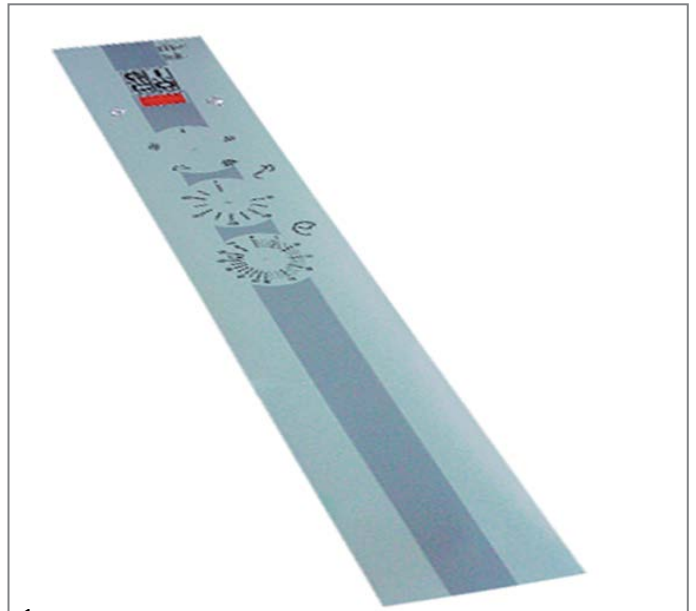

1

<b>Part No.</b>	400277	<b>Ref. No.</b>	293201490 293202430
<b>description</b>	front foil		

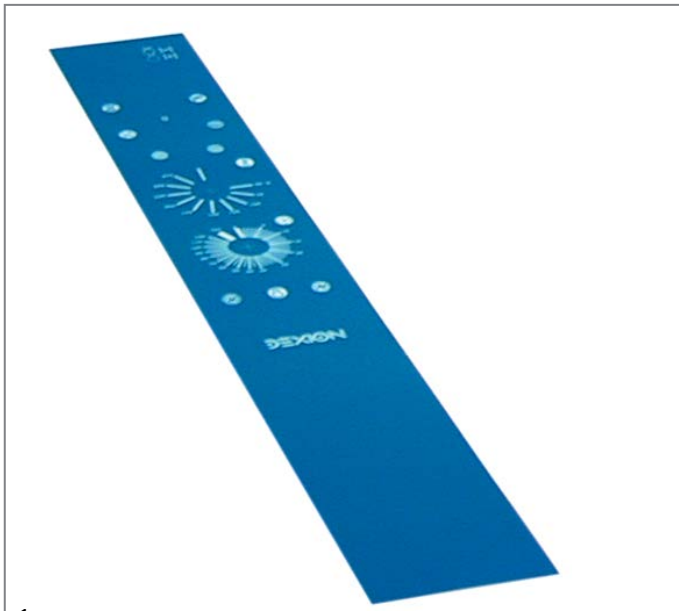

1

<b>Part No.</b>	400276	<b>Ref. No.</b>	293200900
<b>description</b>	front foil		

membrane keypads



1

<b>Part No.</b>	400278	<b>Ref. No.</b>	66201001
<b>description</b>	membrane keypad		



<b>Part No.</b>	400279	<b>Ref. No.</b>	66200001
<b>description</b>	membrane keypad		



<b>Part No.</b>	400280	<b>Ref. No.</b>	66202001
<b>description</b>	membrane keypad		

### solenoid valves

#### solenoid valves (water)

RPE

JOHN GUEST

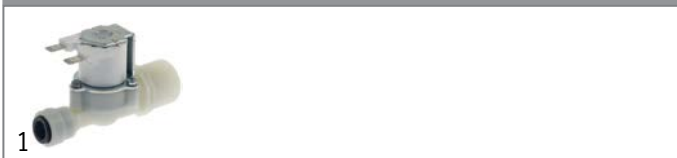

<b>Part No.</b>	374064	<b>Ref. No.</b>	539434110
<b>description</b>	solenoid valve single straight 230VAC inlet 3/4" outlet JG 10 input/ min output/min DN10 t.max. 25/60/90°C duty cycle 100% RPE 160001230V plastic		

### TP



<b>Part No.</b>	370021	<b>Ref. No.</b>	425311034
<b>description</b>	solenoid valve double straight 230VAC inlet 3/4" outlet 11.5mm DN10 TP flow regulating valve inlet white		

<b>spare parts for</b>	370021			
	<b>Part No.</b>	371013	<b>Ref. No.</b>	—
	solenoid coil TP 230VAC 50/60Hz			

<b>accessories for</b>	370021			
	<b>Part No.</b>	371220	<b>Ref. No.</b>	—
	reducer TP flow rate 3l/min red tolerance ±15%			

	<b>Part No.</b>	371221	<b>Ref. No.</b>	—
	reducer TP flow rate 5.5l/min yellow tolerance ±15%			

	<b>Part No.</b>	371222	<b>Ref. No.</b>	—
	reducer TP flow rate 6l/min grey tolerance ±15%			

	<b>Part No.</b>	371223	<b>Ref. No.</b>	—
	reducer TP flow rate 10l/min white tolerance ±15%			

	<b>Part No.</b>	371224	<b>Ref. No.</b>	—
	reducer TP flow rate 12l/min bronze tolerance ±15%			

	<b>Part No.</b>	371225	<b>Ref. No.</b>	—
	reducer TP flow rate 16l/min light brown tolerance ±15%			

	<b>Part No.</b>	371226	<b>Ref. No.</b>	—
	reducer TP flow rate 20l/min red tolerance ±15%			

	<b>Part No.</b>	371230	<b>Ref. No.</b>	—
	reducer TP flow rate 0.25l/min red tolerance ±25%			

	<b>Part No.</b>	371231	<b>Ref. No.</b>	—
	reducer TP flow rate 0.35l/min violet tolerance ±25%			

	<b>Part No.</b>	371232	<b>Ref. No.</b>	—
	reducer TP flow rate 0.5l/min orange tolerance ±25%			

	<b>Part No.</b>	371233	<b>Ref. No.</b>	—
	reducer TP flow rate 0.8l/min white tolerance ±25%			





	<b>Part No.</b>	371234	<b>Ref. No.</b>	—
	reducer TP flow rate 1l/min light blue tolerance ±25%			



	<b>Part No.</b>	371235	<b>Ref. No.</b>	—
	reducer TP flow rate 1.2l/min brown tolerance ±25%			

	<b>Part No.</b>	371236	<b>Ref. No.</b>	—
	reducer TP flow rate 1.5l/min light brown tolerance ±25%			

Table continues overleaf



accessories for		370021		
Part No.	Ref. No.	Ref. No.	Ref. No.	—
	371237	Ref. No.	—	reducer TP flow rate 2.5l/min yellow tolerance ±25%
	371238	Ref. No.	—	reducer TP flow rate 3.4l/min dark green tolerance ±25%
	371239	Ref. No.	—	reducer TP flow rate 5l/min black tolerance ±25%
	371240	Ref. No.	—	reducer TP flow rate 8l/min blue tolerance ±20%

 componenti per elettrodomestici				
 1				
Part No.	Ref. No.	Ref. No.	Ref. No.	53943410240 A00287
description	solenoid valve single straight 230VAC inlet 3/4" outlet 11.5mm DN10 TP p max 10bar			
For models:	110-500A-T, 700-622, 700-632, 700-900, 700-930, 900-622, 900-632, 900-642, 900-652, 900-900, 900-930, 900-940, 900-950, 920-622, 920-632, 920-642, 920-652, 920-900, 920-930, 920-940, 920-950, 9ES-122N, 9ES-122NG, 9ES-152N, 9ES-152NG, 9ES-182N, 9ES-182NG			
spare parts for		370017		
	Part No.	371013	Ref. No.	—
	solenoid coil TP 230VAC 50/60Hz			
accessories for		370017		
	Part No.	371220	Ref. No.	—
	reducer TP flow rate 3l/min red tolerance ±15%			
	Part No.	371221	Ref. No.	—
	reducer TP flow rate 5.5l/min yellow tolerance ±15%			
	Part No.	371222	Ref. No.	—
	reducer TP flow rate 6l/min grey tolerance ±15%			
	Part No.	371223	Ref. No.	—
	reducer TP flow rate 10l/min white tolerance ±15%			
	Part No.	371224	Ref. No.	—
	reducer TP flow rate 12l/min bronze tolerance ±15%			
	Part No.	371225	Ref. No.	—
	reducer TP flow rate 16l/min light brown tolerance ±15%			
	Part No.	371226	Ref. No.	—
	reducer TP flow rate 20l/min red tolerance ±15%			
	Part No.	371230	Ref. No.	—
	reducer TP flow rate 0.25l/min red tolerance ±25%			
	Part No.	371231	Ref. No.	—
	reducer TP flow rate 0.35l/min violet tolerance ±25%			

accessories for		370017		
Part No.	Ref. No.	Ref. No.	Ref. No.	—
	371232	Ref. No.	—	reducer TP flow rate 0.5l/min orange tolerance ±25%
	371233	Ref. No.	—	reducer TP flow rate 0.8l/min white tolerance ±25%
	371234	Ref. No.	—	reducer TP flow rate 1l/min light blue tolerance ±25%
	371235	Ref. No.	—	reducer TP flow rate 1.2l/min brown tolerance ±25%
	371236	Ref. No.	—	reducer TP flow rate 1.5l/min light brown tolerance ±25%
	371237	Ref. No.	—	reducer TP flow rate 2.5l/min yellow tolerance ±25%
	371238	Ref. No.	—	reducer TP flow rate 3.4l/min dark green tolerance ±25%
	371239	Ref. No.	—	reducer TP flow rate 5l/min black tolerance ±25%
	371240	Ref. No.	—	reducer TP flow rate 8l/min blue tolerance ±20%

## pressure switches

for gas equipment



 1				
Part No.	Ref. No.	Ref. No.	Ref. No.	6440001
description	pressure control ø 45mm pressure range adjustable 5-20mbar pressure connection vertical gas technology connection 1/4" pressure connection ø 1/4"mm			

## electrodes

 1				
Part No.	Ref. No.	Ref. No.	Ref. No.	793103640
description	level electrode 1/4" total length 111.5mm probe L 86.5mm insulated probe length 84mm connection male faston 6.3mm stainless steel ø 2.5mm			
For models:	500-755A, 700-755A-S, 700-855A-S, 900-755A-S, 900-855A-S, 920-755A-S			





			
1			
<b>Part No.</b>	400260	<b>Ref. No.</b>	639314125
<b>description</b>	level electrode 1/4" total length 220mm probe L 195mm insulated probe length 185mm PTFE insulated connection male faston 6.3mm stainless steel ø 2.5mm		
<b>accessories for</b>	400260		
	<b>Part No.</b>	521003	<b>Ref. No.</b> —
	nut thread 1/4" H 6.3mm chrome-plated brass WS 20 Qty 1 pcs		

## fans

## axial fans

## ebm-papst

			
1			
<b>Part No.</b>	601030 <sup>1</sup>	<b>Ref. No.</b>	607008
<b>description</b>	axial fan L 119mm W 119mm H 38mm 230VAC 50Hz 18W bearing ball bearing manuf. no. 4656Z metal connection male faston 2.8mm ebm-papst fan wheel ø 110mm temp.-resist. 75°C		
<b>For models:</b>	700-050FEB, 700-052FEB, 700-054FEB, 700-055FEB, 900-050FE, 900-052FE, 900-054FE, 900-172FEA, AB-370080W, AB-370801W, AB-96080W, AB-96801W, AB-96802W, AB-AB03W, BF70120, BF70160, EMD.E061MA, EMD.E061MN, EMD.E061MW, EMD.E081MA, EMD.E081MN, EMD.E081MW, EMD.E101MA, EMD.E101MN, EMD.E101MW, EMD.E102MA, EMD.E102MN, TF-G110-G1101, TF-G138-G1381, TF-G158-G1581, TF-G2060-G2061, TF-N110-N1101-N1102, TF-N138-N1381-N1382, TF-N158, TF-N1581-N1582, TF-N2060-N2061-N2062, TR-G110-G1101, TR-G138-G1381, TR-G158-G1581, TR-G1860-G1861, TR-G2060BN, TR-G2060-G2061, TR-G2061BN, TR-G2341BN, TR-G234BN, TR-G234-G2341, TR-N110-N1101-N1102, TR-N138-N1381-N1382, TR-N158-N1581-N1582, TR-N1860-N1861-N1862... (Other models you can see in the webshop)		
<b>accessories for</b>	601030		
	<b>Part No.</b>	550898	<b>Ref. No.</b> —
	connecting cable cable length 2000mm connection F 2.8 connection distance 7.9mm for axial flow fan		
	<b>Part No.</b>	692497	<b>Ref. No.</b> —
	guard ø 105mm mounting distance 150mm for axial fan ebm-papstmm		

<sup>1</sup>with ball bearings

## hot air motors

			
1			
<b>Part No.</b>	601091	<b>Ref. No.</b>	293200190
<b>description</b>	fan motor 200-240/415V 3 phase 50/60Hz 1HP 1400/1700rpm speeds 1 L1 210mm L2 45mm L3 47mm D1 ø 24mm D2 ø 20mm M8L IT 3.6/2.1A at 50Hz 200-240/415V at 60Hz 200-240/480V at 50Hz 1400rpm at 60Hz 1700rpm type 1040A4450		

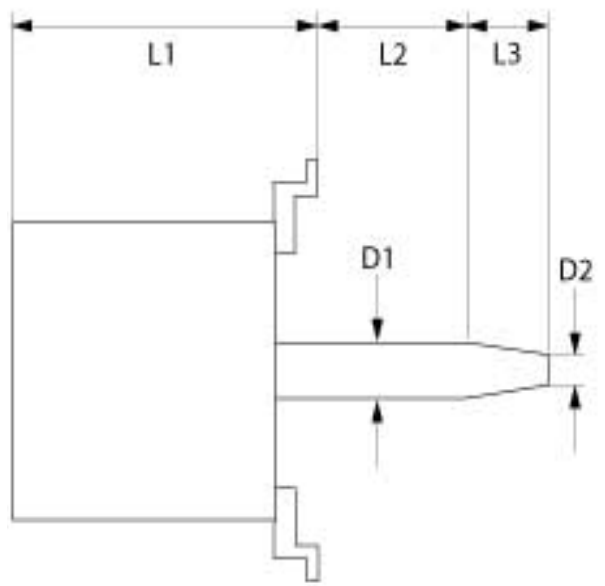
			
1			
<b>Part No.</b>	601848	<b>Ref. No.</b>	A00381
<b>description</b>	fan motor 200-240/415V 3 phase 50/60Hz 1HP 1400rpm speeds 1 L1 210mm L2 45mm L3 47mm D1 ø 24mm D2 ø 20mm M8L IT 3.6/2.1A at 50Hz 200-240/415V at 60Hz 200-240/480V at 50Hz 1400rpm at 60Hz 1700rpm		

1

<b>Part No.</b>	601093	<b>Ref. No.</b>	293201150
<b>description</b>	fan motor 200-240/415V 3 phase 50Hz 0.3/1HP 900/1400rpm speeds 2 L1 210mm L2 50mm L3 45mm D1 ø 24mm D2 ø 20mm M8L IT 3.6/2.1-1.5/0.9A at 50Hz 200-240/415V at 60Hz 200-240/480V at 50Hz 900/1400rpm at 60Hz 1100/1700rpm type 1041A4450		

1

<b>Part No.</b>	601096	<b>Ref. No.</b>	293200240
<b>description</b>	fan wheel D1 ø 285mm H1 140mm blades 24 D2 ø 19.5mm D3 ø 23.5mm H2 45mm		
<b>For models:</b>	EMD.E081MA, EMD.E081MN, EMD.E081MW, EMD.E101MA, EMD.E101MN, EMD.E101MW		

1

<b>Part No.</b>	601090	<b>Ref. No.</b>	293200840
<b>description</b>	fan motor 200-240V 1 phase 50/60Hz 0.18kW 0.25HP 1400rpm speeds 1 L1 123mm L2 41mm L3 30mm D1 ø 15mm D2 ø 10mm M10L ET 1.6A suitable capacitor 5µF/450V at 50Hz 1400rpm at 60Hz 1700rpm type 1071		

1

<b>Part No.</b>	601097	<b>Ref. No.</b>	293201100
<b>description</b>	fan wheel D1 ø 310mm H1 160mm blades 24 D2 ø 19.5mm D3 ø 23mm H2 46mm		
<b>For models:</b>	EMD.E102MA, EMD.E102MN		

1

<b>Part No.</b>	601092	<b>Ref. No.</b>	293200420
<b>description</b>	fan motor 200-240V 1 phase 50Hz 0.1/0.25HP 900/1400rpm speeds 2 L1 123mm L2 41mm L3 30mm D1 ø 15mm D2 ø 10mm M10L ET 1/0.6A suitable capacitor 5µF/450V at 50Hz 900/1400rpm at 60Hz 1100/1700rpm type 1071		

1

<b>Part No.</b>	601095	<b>Ref. No.</b>	293200680
<b>description</b>	fan wheel D1 ø 210mm H1 100mm blades 20 D2 ø 11mm D3 ø 16mm H2 30mm		
<b>For models:</b>	EMD.E061MA, EMD.E061MN, EMD.E061MW		



hot air fans

miscellaneous

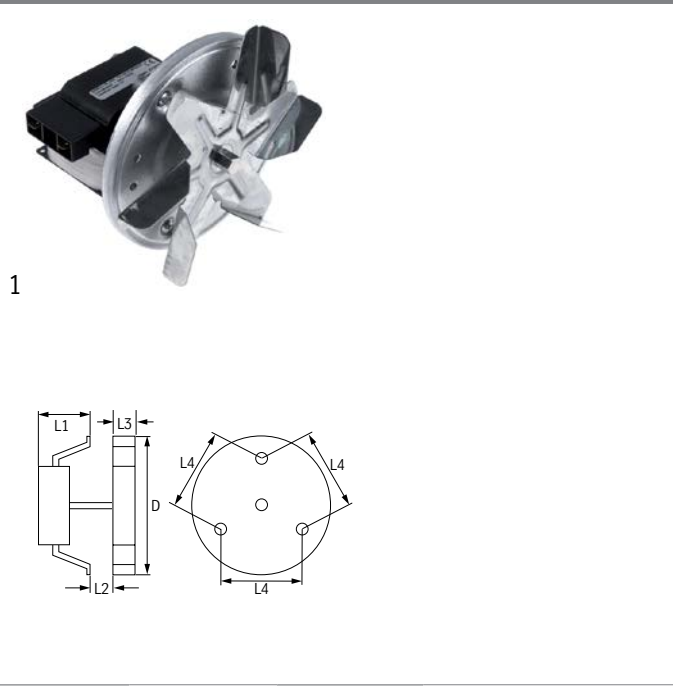

<b>Part No.</b>	601094	<b>Ref. No.</b>	507005 507007 507009
<b>description</b>	fan motor 240V 36W 50Hz L1 85mm L2 15mm L3 20mm L4 87mm fan wheel ø 150mm Emmevi type 260305X		
<b>For models:</b>	9ES-122N, 9ES-152N, 9ES-182N, ES-121NVC, ES-151NVC, ES-181NVC		

condensators & interference suppression filters

operating capacitors



<b>Part No.</b>	365017	<b>Ref. No.</b>	6410005
<b>description</b>	operating capacitor capacity 5µF 450V tolerance 5% 50/60Hz ambient temperature max. -25 to +85°C ø 28mm L 54mm M8 plastic connection male faston 6.3mm 16.10.08 protection		
<b>For models:</b>	EMD.E061MA, EMD.E061MN, EMD.E061MW		

electric accessories

terminals

connection terminals with screw/faston connections



<b>Part No.</b>	550411	<b>Ref. No.</b>	652502
<b>description</b>	power terminal block 6-pole max. 40A max 450V connection ø6mm² / F6.3 temp.-resist. 150°C cross section 6mm²		
<b>For models:</b>	110-500A-T, 500-039A, 500-701A, 500-755A, 64-050FCE, 64-050FEFEV, 64-050T, 64-057FE, 64-057T, 64-700T, 64-703T, 64-755T, 700-037A-T, 700-039A, 700-050FEB, 700-055A-C-T, 700-055FEB, 700-057A-T, 700-057FEB, 700-500A-C-T, 700-542A-C-T, 700-622, 700-701A-S, 700-702A-S, 700-704A-S, 700-705A-S, 700-708A-S, 700-755A-S, 700-855A-S, 700-900, 900-037A-T, 900-038A-058A, 900-038AM-058AM, 900-039A, 900-050A-C-T, 900-050FE, 900-057A-T, 900-057FE, 900-172A-C-T, 900-172FEA, 900-500A-C-T, 900-542A-C-T, 900-622, 900-642, 900-701A-S, 900-702A-S, 900-704A-S, 900-705A-S, 900-706A-S, 900-755A-S...(Other models you can see in the webshop)		

pumps

booster pumps II

accessories



<b>Part No.</b>	365017	<b>Ref. No.</b>	6410005
<b>description</b>	operating capacitor capacity 5µF 450V tolerance 5% 50/60Hz ambient temperature max. -25 to +85°C ø 28mm L 54mm M8 plastic connection male faston 6.3mm 16.10.08 protection		
<b>For models:</b>	EMD.E061MA, EMD.E061MN, EMD.E061MW		



## gas taps

### PEL

#### 20N series



1

<b>Part No.</b>	101398	<b>Ref. No.</b>	435213
<b>description</b>	gas tap PEL type 20N gas inlet M16x1.5 (tube ø 10mm) bypass nozzle ø 0.35mm gas outlet M16x1.5 (tube ø 10/8mm) thermocouple connection pilot connection M10x1 shaft ø 8x6.5mm shaft L 22/15mm shaft flat upper		
<b>spare parts for</b>	101398		
	<b>Part No.</b>	100408	<b>Ref. No.</b> —
	bypass nozzle type PEL20/21 bore ø 0.35mm thread M5x0.5		
	<b>Part No.</b>	101205	<b>Ref. No.</b> —
	gas tap front part shaft ø 8x6.5mm shaft L 22/15mm shaft flat upper/lower suitable for PEL20		
<b>accessories for</b>	101398		
	<b>Part No.</b>	101278	<b>Ref. No.</b> —
	olive for pipe ø 10mm Qty 1 pcs		
	<b>Part No.</b>	101300	<b>Ref. No.</b> —
	union nut thread M16x1.5 tube ø 10mm		
	<b>Part No.</b>	101450	<b>Ref. No.</b> —
	olive for pipe ø 8mm L 12.7mm Qty 1 pcs ED ø 10mm		
	<b>Part No.</b>	101451	<b>Ref. No.</b> —
	union nut thread M16x1.5 tube ø 8mm		
	<b>Part No.</b>	110081	<b>Ref. No.</b> —
	knob ø 70mm shaft ø 8x6.5mm shaft flat universal		
	<b>Part No.</b>	110083	<b>Ref. No.</b> —
	knob dial plate gas tap without ignition flame silver		

#### 20S series















1

<b>Part No.</b>	101094	<b>Ref. No.</b>	435212
<b>description</b>	gas tap PEL type 20S gas inlet M16x1.5 (tube ø 10mm) bypass nozzle ø 0.35mm gas outlet M16x1.5 (tube ø 10/8mm) thermocouple connection M8x1 pilot connection shaft ø 8x6.5mm shaft L 22/15mm shaft flat lower		
<b>For models:</b>	64-020T-64-040T, 64-040FCE, 64-040FE, 64-040F-FV, 64-222F, 64-222FCE, 64-222FE, 64-222T		
<b>spare parts for</b>	101094		
	<b>Part No.</b>	100408	<b>Ref. No.</b> —
	bypass nozzle type PEL20/21 bore ø 0.35mm thread M5x0.5		
	<b>Part No.</b>	101060	<b>Ref. No.</b> —
	magnet unit standard L 39mm D1 ø 15.4mm D2 ø 11mm suitable for PEL20-21/JUNKERS/EGA		
	<b>Part No.</b>	101205	<b>Ref. No.</b> —
	gas tap front part shaft ø 8x6.5mm shaft L 22/15mm shaft flat upper/lower suitable for PEL20		
	<b>Part No.</b>	101230	<b>Ref. No.</b> —
	thermocouple nut T1: M8x1 T2: M18x1 aluminium		
<b>accessories for</b>	101094		
	<b>Part No.</b>	101278	<b>Ref. No.</b> —
	olive for pipe ø 10mm Qty 1 pcs		
	<b>Part No.</b>	101300	<b>Ref. No.</b> —
	union nut thread M16x1.5 tube ø 10mm		
	<b>Part No.</b>	101450	<b>Ref. No.</b> —
	olive for pipe ø 8mm L 12.7mm Qty 1 pcs ED ø 10mm		
	<b>Part No.</b>	101451	<b>Ref. No.</b> —
	union nut thread M16x1.5 tube ø 8mm		
	<b>Part No.</b>	110081	<b>Ref. No.</b> —
	knob ø 70mm shaft ø 8x6.5mm shaft flat universal		
	<b>Part No.</b>	110083	<b>Ref. No.</b> —
	knob dial plate gas tap without ignition flame silver		



## 21S series

			
1			
<b>Part No.</b>	101095	<b>Ref. No.</b>	435210
<b>description</b>	gas tap PEL type 21S gas inlet M16x1.5 (tube $\varnothing$ 10mm) bypass nozzle $\varnothing$ 0.35mm gas outlet M16x1.5 (tube $\varnothing$ 10/8mm) thermocouple connection M8x1 pilot connection M10x1 shaft $\varnothing$ 8x6.5mm shaft L 22/15mm shaft flat lower		
<b>For models:</b>	64-125T-126T, 64-130TL-TR, 64-132TL-TLR-TR, 64-222F, 64-222FCE, 64-222FE, 64-222T, 64-900T, 700-020A-C-T, 700-040A-C-T, 700-040FB, 700-040FEB, 700-125T, 700-126T, 700-127T, 700-130AL-AR, 700-130CL-CR, 700-130TL-TR, 700-132AL-AR, 700-132ALR, 700-132CLCR, 700-132CLR, 700-132TLR, 700-132TL-TR, 700-138A-C-T, 700-138FBA, 700-138FEBA, 700-162A-C-T, 700-162FBA, 700-162FEBA, 700-162FG, 700-222A-C, 700-222FB, 700-222FEB, 700-222T, 700-224A-C, 700-224FBA, 700-224FEBA, 700-224FG, 700-224T, 900-020A-C-T, 900-040A-C-T, 900-040F, 900-040FE, 900-125T, 900-126T, 900-127T, 900-130AL-AR, 900-130CL-CR, 900-130TL-TR...(Other models you can see in the webshop)		
<b>spare parts for</b>	101095		
	<b>Part No.</b>	100408	<b>Ref. No.</b> —
	bypass nozzle type PEL20/21 bore $\varnothing$ 0.35mm thread M5x0.5		
	<b>Part No.</b>	101060	<b>Ref. No.</b> —
	magnet unit standard L 39mm D1 $\varnothing$ 15.4mm D2 $\varnothing$ 11mm suitable for PEL20-21/JUNKERS/EGA		
	<b>Part No.</b>	101206	<b>Ref. No.</b> —
	gas tap front part shaft $\varnothing$ 8x6.5mm shaft L 22/15mm shaft flat upper/lower suitable for PEL21		
<b>accessories for</b>	101095		
	<b>Part No.</b>	100908	<b>Ref. No.</b> —
	union screw thread M10x1 for pipe $\varnothing$ 4mm Qty 1 pcs		
	<b>Part No.</b>	100909	<b>Ref. No.</b> —
	union screw thread M10x1 for pipe $\varnothing$ 6mm Qty 1 pcs		
	<b>Part No.</b>	101246	<b>Ref. No.</b> —
	olive for pipe $\varnothing$ 4mm Qty 1 pcs		
	<b>Part No.</b>	101278	<b>Ref. No.</b> —
	olive for pipe $\varnothing$ 10mm Qty 1 pcs		
	<b>Part No.</b>	101286	<b>Ref. No.</b> —
	olive ID $\varnothing$ 6mm Qty 1 pcs		
	<b>Part No.</b>	101300	<b>Ref. No.</b> —
	union nut thread M16x1.5 tube $\varnothing$ 10mm		
	<b>Part No.</b>	101450	<b>Ref. No.</b> —
	olive for pipe $\varnothing$ 8mm L 12.7mm Qty 1 pcs ED $\varnothing$ 10mm		
	<b>Part No.</b>	101451	<b>Ref. No.</b> —
	union nut thread M16x1.5 tube $\varnothing$ 8mm		
	<b>Part No.</b>	110081	<b>Ref. No.</b> —
	knob $\varnothing$ 70mm shaft $\varnothing$ 8x6.5mm shaft flat universal		

accessories for 101095



Part No. 112206

Ref. No.

—

knob dial plate silver gas tap PEL21/22/23 t.max.°C ED  $\varnothing$  63mm ID  $\varnothing$  45.5mm

## 22S/O series











			
1			
<b>Part No.</b>	101089	<b>Ref. No.</b>	435221
<b>description</b>	gas tap PEL type 22S/O gas inlet M20x1.5 (tube $\varnothing$ 12mm) bypass nozzle $\varnothing$ 0.35mm gas outlet M20x1.5 (tube $\varnothing$ 12/10mm) thermocouple connection M8x1 pilot connection M10x1 shaft $\varnothing$ 10x8mm shaft L 25/17mm shaft flat upper		
<b>For models:</b>	110-200A-T, 110-200F, 110-200FE, 500-125A-126A, 500-750A, 500-800A, 700-125A-C, 700-126A-C, 700-127A-C, 700-138A-C-T, 700-138FBA, 700-138FEBA, 700-200A-C-T, 700-200FB, 700-200FEB, 700-750A-S, 700-800A-S, 900-125A-C, 900-126A-C, 900-127A-C, 900-138A-C-T, 900-138FA, 900-138FEA, 900-200A-C-T, 900-200F, 900-200FE, 900-750A-S, 900-800A-S, 90-301, 920-200A-T, 920-200F, 920-200FE, 920-750A-S		
<b>spare parts for</b>	101089		
	<b>Part No.</b>	100259	<b>Ref. No.</b> —
	bypass nozzle type PEL22 bore $\varnothing$ 0.35mm thread M6x0.5		
	<b>Part No.</b>	101058	<b>Ref. No.</b> —
	magnet unit L 39mm D1 $\varnothing$ 15.4mm D2 $\varnothing$ 13.5mm suitable for PEL22/EGA24197 standard		
	<b>Part No.</b>	101201	<b>Ref. No.</b> —
	gas tap front part shaft $\varnothing$ 10x8mm shaft L 25/17mm shaft flat upper/lower suitable for PEL22		
	<b>Part No.</b>	101230	<b>Ref. No.</b> —
	thermocouple nut T1: M8x1 T2: M18x1 aluminium		
	<b>Part No.</b>	101240	<b>Ref. No.</b> —
	gas connection thread M20x1.5 tube $\varnothing$ 12/10mm for PEL gas taps with gasket and screws horizontal		
	<b>Part No.</b>	101460	<b>Ref. No.</b> —
	O-ring $\varnothing$ 12.37mm D1 $\varnothing$ 2.62mm suitable for PEL22		
	<b>Part No.</b>	101461	<b>Ref. No.</b> —
	screw kit suitable for PEL22 Qty 4 pcs		
<b>accessories for</b>	101089		
	<b>Part No.</b>	100908	<b>Ref. No.</b> —
	union screw thread M10x1 for pipe $\varnothing$ 4mm Qty 1 pcs		
	<b>Part No.</b>	100909	<b>Ref. No.</b> —
	union screw thread M10x1 for pipe $\varnothing$ 6mm Qty 1 pcs		
	<b>Part No.</b>	101241	<b>Ref. No.</b> —
	gas connection thread M20x1.5 tube $\varnothing$ 12/10mm for PEL gas taps vertical		
	<b>Part No.</b>	101246	<b>Ref. No.</b> —
	olive for pipe $\varnothing$ 4mm Qty 1 pcs		

Table continues overleaf



accessories for		101089		
Part No.		101248	Ref. No.	—
	olive for pipe ø 12mm Qty 1 pcs suitable for PEL			
	olive for pipe ø 10mm Qty 1 pcs	101249	Ref. No.	270201580
	union nut thread M20x1.5 for pipe ø 10mm	101250	Ref. No.	270201680
	union nut thread M20x1.5 for pipe ø 12mm	101251	Ref. No.	—
	olive ID ø 6mm Qty 1 pcs	101286	Ref. No.	—
	knob ø 70mm shaft ø 10x8mm shaft flat universal	110080	Ref. No.	—
	knob dial plate silver gas tap PEL21/22/23 t.max.°C ED ø 63mm ID ø 45.5mm	112206	Ref. No.	—

accessories for		101092		
Part No.		100909	Ref. No.	—
	union screw thread M10x1 for pipe ø 6mm Qty 1 pcs			
	olive for pipe ø 4mm Qty 1 pcs	101246	Ref. No.	—
	union nut thread M24x1.5 for pipe ø 12mm	101252	Ref. No.	—
	union nut thread M24x1.5 PEL for pipe ø 16mm	101253	Ref. No.	—
	union nut thread M28x1.5 tube ø 20mm	101254	Ref. No.	—
	olive for pipe ø 12mm Qty 1 pcs	101255	Ref. No.	—
	olive for pipe ø 16mm Qty 1 pcs	101256	Ref. No.	—
	olive for pipe ø 20mm Qty 1 pcs	101257	Ref. No.	—
	olive ID ø 6mm Qty 1 pcs	101286	Ref. No.	—
	knob ø 70mm shaft ø 10x8mm shaft flat universal	110080	Ref. No.	—
	knob dial plate silver gas tap PEL21/22/23 t.max.°C ED ø 63mm ID ø 45.5mm	112206	Ref. No.	—

23S/O series

				
<b>Part No.</b>	101092	<b>Ref. No.</b>	435280	
<b>description</b>	gas tap PEL type 23S/O gas inlet M28x1.5 (tube ø 20mm) bypass nozzle ø 0.35mm gas outlet M24x1.5 (tube ø 16mm) thermocouple connection M10x1 pilot connection M10x1 shaft ø 10x8mm shaft L 25/17mm shaft flat upper			
<b>For models:</b>	700-508, 900-503, 900-506, 920-503, 920-506			
<b>spare parts for</b>	101092			
	Part No.	100455	Ref. No.	—
	bypass nozzle type PEL23/24 bore ø 0.35mm thread M8x0.5			
	Part No.	101059	Ref. No.	—
	magnet unit T1: M10x1 T2: M22x1 L 46mm ø 18mm suitable for PEL23S M10x1			
	Part No.	101204	Ref. No.	—
	gas tap front part shaft ø 10x8mm shaft L 25/17mm shaft flat upper/lower suitable for PEL23S			
	Part No.	101244	Ref. No.	—
	gas connection thread M24x1.5 tube ø 12/16mm horizontal for PEL gas taps			
	Part No.	101463	Ref. No.	—
	screw suitable for PEL23S Qty 4 pcs			
	Part No.	528455	Ref. No.	—
	O-ring Viton thickness 2.62mm ID ø 18.72mm Qty 1 pcs			
<b>accessories for</b>	101092			
	Part No.	100908	Ref. No.	—
	union screw thread M10x1 for pipe ø 4mm Qty 1 pcs			

gas thermostats





SIT

630 Eurosit series

				
<b>Part No.</b>	101413	<b>Ref. No.</b>	A00414	
<b>description</b>	gas thermostat type 630 Eurosit series t.max. 100°C 30-100°C gas inlet 3/8" gas outlet 3/8" thermocouple connection M9x1 pilot connection M10x1 probe ø 5mm probe L 122mm capillary pipe 1050mm SIT			
<b>For models:</b>	700-400A-C-T, 700-402A-C-T, 900-400A-C-T, 900-402A-C-T, 920-400AT, 920-402A-T			
<b>accessories for</b>	101413			
	Part No.	100904	Ref. No.	4392050
	locking screw M10x1 for pipe ø 4mm Qty 1 pcs			

Table continues overleaf



<b>accessories for</b> 101413			
	Part No.	100905	Ref. No. —
locking screw M10x1 for pipe ø 6mm Qty 1 pcs			
	Part No.	101273	Ref. No. —
olive for pipe ø 12mm L 9.5mm brass Qty 1 pcs suitable for universal			
	Part No.	101276	Ref. No. —
union screw thread 3/8" tube ø 12mm Qty 1 pcs			
	Part No.	101333	Ref. No. —
plug thread 3/8" with O-ring			

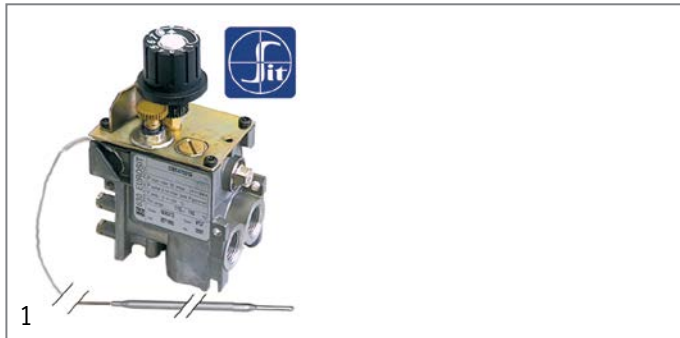

<b>Part No.</b>	101188	<b>Ref. No.</b>	A00405
<b>description</b>	gas thermostat type 630 Eurosit series t.max. 190°C 110-190°C gas inlet 3/8" gas outlet 3/8" thermocouple connection M9x1 pilot connection M10x1 probe ø 4mm probe L 202mm capillary pipe 1050mm SIT		
<b>For models:</b>	500-601A, 700-601A-S, 700-602A-S, 700-603A, 700-604A-605A, 900-601A-S, 900-602A-S, 900-604A-S, 900-605A-S, 920-604A-S		
<b>accessories for</b> 101188			
	Part No.	100904	Ref. No. 4392050
locking screw M10x1 for pipe ø 4mm Qty 1 pcs			
	Part No.	100905	Ref. No. —
locking screw M10x1 for pipe ø 6mm Qty 1 pcs			
	Part No.	101273	Ref. No. —
olive for pipe ø 12mm L 9.5mm brass Qty 1 pcs suitable for universal			
	Part No.	101276	Ref. No. —
union screw thread 3/8" tube ø 12mm Qty 1 pcs			
	Part No.	101333	Ref. No. —
plug thread 3/8" with O-ring			

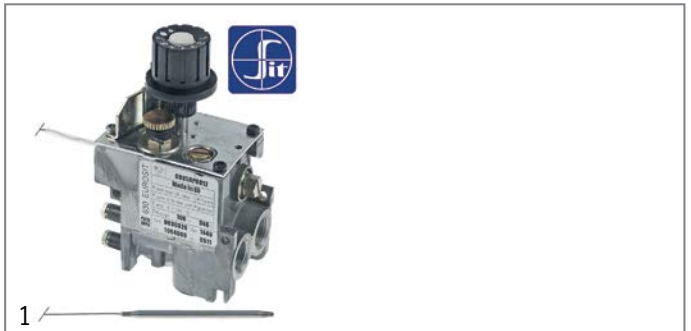

<b>Part No.</b>	101125	<b>Ref. No.</b>	A00406
<b>description</b>	gas thermostat type 630 Eurosit series t.max. 340°C 100-340°C gas inlet 3/8" gas outlet 3/8" thermocouple connection M9x1 pilot connection M10x1 probe ø 4mm probe L 72mm capillary pipe 1050mm SIT		
<b>For models:</b>	110-120AL-ALR, 110-120TL-TLR, 110-122AL-ALR, 110-122ALC, 110-122FELC, 110-122FEL-FELR, 110-122FLC, 110-122FL-FLR, 110-122TL, 110-122TL-TLR, 110-200F, 500-120AL-AR, 500-120ALC, 500-120TLC, 500-120TL-TR, 500-122AL-ALR-AR, 500-122ALC, 500-122TLC, 500-122TL-TLR-TR, 64-040F-FV, 64-120TLC, 64-120TL-TR, 64-122TL, 64-122TLC, 64-122TLR-TR, 64-222F, 700-040FB, 700-120AL-AR-CL, 700-120ALC-CLC, 700-120CR-TL, 700-120TLC, 700-120TR, 700-122AL, 700-122ALC, 700-122ALR-AR-CL, 700-122CLC, 700-122CLR-CR-TL, 700-122TLC, 700-122TLR-TR, 700-138FBA, 700-162FG, 700-200FB, 700-222FB, 700-224FBA, 700-224FG, 700-401B, 900-040F, 900-120ALAR, 900-120ALC, 900-120CL-CR...(Other models you can see in the webshop)		
<b>accessories for</b> 101125			
	Part No.	100825	Ref. No. —
gas tap spindle shaft ø 8x6.5mm shaft L 22/14mm suitable for EUROSIT			
	Part No.	100904	Ref. No. 4392050
locking screw M10x1 for pipe ø 4mm Qty 1 pcs			
	Part No.	100905	Ref. No. —
locking screw M10x1 for pipe ø 6mm Qty 1 pcs			
	Part No.	100949	Ref. No. —
gasket suitable for 630 Eurosit series			
	Part No.	101273	Ref. No. —
olive for pipe ø 12mm L 9.5mm brass Qty 1 pcs suitable for universal			
	Part No.	101276	Ref. No. —
union screw thread 3/8" tube ø 12mm Qty 1 pcs			
	Part No.	101333	Ref. No. —
plug thread 3/8" with O-ring			
	Part No.	101390	Ref. No. —
gas tap spindle shaft ø 6x4.6mm shaft L 32/15mm gas tap with ignition flame suitable for ZANUSSI, MARENO for gas thermostat EUROSIT			
	Part No.	101392	Ref. No. —
adapter suitable for 630 Eurosit series			
	Part No.	110357	Ref. No. —
gas tap spindle shaft ø 8x6.5mm shaft L 36/12mm suitable for 630 Eurosit series			
	Part No.	110358	Ref. No. —
adapter shaft ø 10x8mm shaft L 29/18mm suitable for 630 Eurosit series			





710 Minisit series

<b>Part No.</b>	101132	<b>Ref. No.</b>	433011 770203180
<b>description</b>	gas thermostat SIT type MINISIT 710 t.max. 340°C 100-340°C gas inlet 1/2" gas outlet 3/8" thermocouple connection M9x1 pilot connection M10x1 probe Ø 5mm probe L 68mm capillary pipe 1050mm probe type type B1 pressure controller no pressure regulator mbar gland nut ignition gas no		
<b>spare parts for</b>	101132		
	<b>Part No.</b>	101053	<b>Ref. No.</b> —
	magnet unit T1: M9x1 T2: M24x1 L 45mm Ø 17mm suitable for Minisit		
	<b>Part No.</b>	102102	<b>Ref. No.</b> —
	probe 100-340°C probe Ø 5mm probe L 68mm capillary pipe 1750mm t.max. 340°C oven/grill probe type type B1 suitable for MINISIT 710		
<b>accessories for</b>	101132		
	<b>Part No.</b>	100809	<b>Ref. No.</b> —
	O-ring EPDM thickness 2mm ID Ø 21mm Qty 1 pcs		
	<b>Part No.</b>	100904	<b>Ref. No.</b> 4392050
	locking screw M10x1 for pipe Ø 4mm Qty 1 pcs		
	<b>Part No.</b>	100905	<b>Ref. No.</b> —
	locking screw M10x1 for pipe Ø 6mm Qty 1 pcs		
	<b>Part No.</b>	101054	<b>Ref. No.</b> —
	magnet unit T1: M10x1 T2: M24x1 L 45mm Ø 17mm suitable for Minisit		
	<b>Part No.</b>	101136	<b>Ref. No.</b> —
	piezoelectric igniter suitable for Minisit with cover cap Ømm connection F6.3x0.8		
	<b>Part No.</b>	101137	<b>Ref. No.</b> —
	cover cap without piezoelectric igniter		
	<b>Part No.</b>	101267	<b>Ref. No.</b> —
	reducer IT 3/8" ET 1/2" L 21mm		
	<b>Part No.</b>	101268	<b>Ref. No.</b> —
	gas connection thread 3/8" angled with O-ring MINISIT 710		
	<b>Part No.</b>	101269	<b>Ref. No.</b> —
	gas connection thread 1/2" angled with O-ring MINISIT 710		
	<b>Part No.</b>	101270	<b>Ref. No.</b> —
	screw connection IT 3/8" ET 3/8" L 28mm		
	<b>Part No.</b>	101272	<b>Ref. No.</b> —
	screw connection IT 1/2" ET 3/8" L 57mm		
	<b>Part No.</b>	101273	<b>Ref. No.</b> —
	olive for pipe Ø 12mm L 9.5mm brass Qty 1 pcs suitable for universal		

<b>accessories for</b>	101132		
	<b>Part No.</b>	101274	<b>Ref. No.</b> —
	olive for pipe Ø 16mm Qty 1 pcs		
	<b>Part No.</b>	101275	<b>Ref. No.</b> —
	union screw thread 1/2" for pipe Ø 16mm Qty 1 pcs		
	<b>Part No.</b>	101276	<b>Ref. No.</b> —
	union screw thread 3/8" tube Ø 12mm Qty 1 pcs		
	<b>Part No.</b>	110068	<b>Ref. No.</b> —
	knob suitable for Minisit Ø 37mm		

<b>Part No.</b>	101114 <sup>1</sup>	<b>Ref. No.</b>	433208 A00044
<b>description</b>	gas thermostat with pressure controller SIT type MINISIT 710 t.max. 190°C 110-190°C gas inlet 1/2" gas outlet 3/8" thermocouple connection M9x1 pilot connection M10x1 probe Ø 10.5mm probe L 26mm capillary pipe 1050mm probe type type F3 pressure controller yes pressure regulator 3-18mbar gland nut		
<b>spare parts for</b>	101114		
	<b>Part No.</b>	101053	<b>Ref. No.</b> —
	magnet unit T1: M9x1 T2: M24x1 L 45mm Ø 17mm suitable for Minisit		
	<b>Part No.</b>	102104	<b>Ref. No.</b> 439621019
	probe 110-190°C probe Ø 11mm probe thread 1/4" probe L 26mm capillary pipe 1050mm t.max. 190°C fryer probe type type F3 suitable for MINISIT 710		
<b>accessories for</b>	101114		
	<b>Part No.</b>	100809	<b>Ref. No.</b> —
	O-ring EPDM thickness 2mm ID Ø 21mm Qty 1 pcs		
	<b>Part No.</b>	100820	<b>Ref. No.</b> —
	gland duct ET M14x1.5 IT M10x0.75 probe Ø max. 6.5mm WS 22		
	<b>Part No.</b>	100904	<b>Ref. No.</b> 4392050
	locking screw M10x1 for pipe Ø 4mm Qty 1 pcs		
	<b>Part No.</b>	100905	<b>Ref. No.</b> —
	locking screw M10x1 for pipe Ø 6mm Qty 1 pcs		
	<b>Part No.</b>	101054	<b>Ref. No.</b> —
	magnet unit T1: M10x1 T2: M24x1 L 45mm Ø 17mm suitable for Minisit		
	<b>Part No.</b>	101136	<b>Ref. No.</b> —
	piezoelectric igniter suitable for Minisit with cover cap Ømm connection F6.3x0.8		
	<b>Part No.</b>	101137	<b>Ref. No.</b> —
	cover cap without piezoelectric igniter		

<sup>1</sup>probe thread 1/4"  
Table continues overleaf

1 gas components







accessories for 101114	
	Part No. 101267 Ref. No. — reducer IT 3/8" ET 1/2" L 21mm
	Part No. 101268 Ref. No. — gas connection thread 3/8" angled with O-ring MINISIT 710
	Part No. 101269 Ref. No. — gas connection thread 1/2" angled with O-ring MINISIT 710
	Part No. 101270 Ref. No. — screw connection IT 3/8" ET 3/8" L 28mm
	Part No. 101272 Ref. No. — screw connection IT 1/2" ET 3/8" L 57mm
	Part No. 101273 Ref. No. — olive for pipe ø 12mm L 9.5mm brass Qty 1 pcs suitable for universal
	Part No. 101274 Ref. No. — olive for pipe ø 16mm Qty 1 pcs
	Part No. 101275 Ref. No. — union screw thread 1/2" for pipe ø 16mm Qty 1 pcs
	Part No. 101276 Ref. No. — union screw thread 3/8" tube ø 12mm Qty 1 pcs
	Part No. 110068 Ref. No. — knob suitable for Minisit ø 37mm
	Part No. 361182 Ref. No. — nut thread 1/4" H 5mm nickel-plated brass WS 17 Qty 1 pcs
	Part No. 532520 Ref. No. — O-ring silicone thickness 2.62mm ID ø 15.08mm Qty 1 pcs

**accessories**

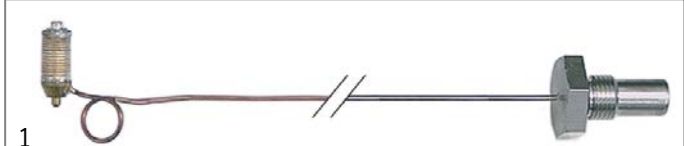
**probes**

	1		
<b>Part No.</b>	102101	<b>Ref. No.</b>	439631034
<b>description</b>	probe 100-340°C probe ø 5mm probe L 70mm capillary pipe 1000mm t.max. 340°C suitable for MINISIT 710		

	1		
<b>Part No.</b>	102104 <sup>1</sup>	<b>Ref. No.</b>	439621019
<b>description</b>	probe 110-190°C probe ø 11mm probe thread 1/4" probe L 26mm capillary pipe 1050mm t.max. 190°C fryer probe type type F3 suitable for MINISIT 710		
<b>accessories for</b>	102104		
	Part No. 361182	Ref. No.	—
	Part No. 510420	Ref. No.	—
	Part No. 529251	Ref. No.	—
	O-ring EPDM thickness 2.62mm ID ø 15.08mm Qty 1 pcs		

<sup>1</sup>probe thread 1/4"

**PEL**

**24ST series**

















	1		
<b>Part No.</b>	101078	<b>Ref. No.</b>	435218
<b>description</b>	gas thermostat PEL type 24ST 55-110°C gas inlet M20x1.5 (tube ø 12mm) bypass nozzle ø 0.35mm gas outlet M20x1.5 (tube ø 12/10mm) thermocouple connection M9x1 pilot connection M10x1 capillary pipe 1200mm probe ø 6mm probe L 160mm shaft ø 10x8mm shaft L 27/17mm shaft flat upper		
<b>spare parts for</b>	101078		
	Part No. 100455	Ref. No.	—
	bypass nozzle type PEL23/24 bore ø 0.35mm thread M8x0.5		
	Part No. 101058	Ref. No.	—
	magnet unit L 39mm D1 ø 15.4mm D2 ø 13.5mm suitable for PEL22/EGA24197 standard		
	Part No. 106200	Ref. No.	—
	nut thread M9x1 suitable for PEL 24/25S		
<b>accessories for</b>	101078		
	Part No. 100908	Ref. No.	—
	union screw thread M10x1 for pipe ø 4mm Qty 1 pcs		
	Part No. 100909	Ref. No.	—
	union screw thread M10x1 for pipe ø 6mm Qty 1 pcs		
	Part No. 101246	Ref. No.	—
	olive for pipe ø 4mm Qty 1 pcs		
	Part No. 101248	Ref. No.	—
	olive for pipe ø 12mm Qty 1 pcs suitable for PEL		
	Part No. 101249	Ref. No.	270201580
	olive for pipe ø 10mm Qty 1 pcs		

Table continues overleaf



accessories for		101078		
Part No.		101250	Ref. No.	270201680
	union nut	thread M20x1.5 for pipe ø 10mm		
	Part No.	101251	Ref. No.	—
	union nut	thread M20x1.5 for pipe ø 12mm		
	Part No.	101286	Ref. No.	—
	olive	ID ø 6mm Qty 1 pcs		
	Part No.	110079	Ref. No.	—
	knob dial plate	gas thermostat 1-8 silver		
	Part No.	110080	Ref. No.	—
	knob	ø 70mm shaft ø 10x8mm shaft flat universal		

accessories for		101172		
Part No.		110079	Ref. No.	—
	knob dial plate	gas thermostat 1-8 silver		
	Part No.	110081	Ref. No.	—
	knob	ø 70mm shaft ø 8x6.5mm shaft flat universal		

25ST series





Part No.	101172	Ref. No.	435219	
<b>description</b>	gas thermostat PEL type 25ST 100-300°C gas inlet M16x1.5 (tube ø 10mm) bypass nozzle ø 0.35mm gas outlet M16x1.5 (tube ø 10/8mm) thermocouple connection M9x1 pilot connection M10x1 capillary pipe 1200mm probe ø 6mm probe L 100mm shaft ø 8x6.5mm shaft L 21/15mm shaft flat upper			
<b>spare parts for</b>		101172		
	Part No.	100259	Ref. No.	—
	bypass nozzle	type PEL22 bore ø 0.35mm thread M6x0.5		
	Part No.	101060	Ref. No.	—
	magnet unit	standard L 39mm D1 ø 15.4mm D2 ø 11mm suitable for PEL20-21/JUNKERS/EGA		
	Part No.	106200	Ref. No.	—
	nut	thread M9x1 suitable for PEL 24/25S		
<b>accessories for</b>		101172		
	Part No.	100908	Ref. No.	—
	union screw	thread M10x1 for pipe ø 4mm Qty 1 pcs		
	Part No.	100909	Ref. No.	—
	union screw	thread M10x1 for pipe ø 6mm Qty 1 pcs		
	Part No.	101246	Ref. No.	—
	olive	for pipe ø 4mm Qty 1 pcs		
	Part No.	101278	Ref. No.	—
	olive	for pipe ø 10mm Qty 1 pcs		
	Part No.	101286	Ref. No.	—
	olive	ID ø 6mm Qty 1 pcs		
	Part No.	101300	Ref. No.	—
	union nut	thread M16x1.5 tube ø 10mm		
	Part No.	101450	Ref. No.	—
	olive	for pipe ø 8mm L 12.7mm Qty 1 pcs ED ø 10mm		
	Part No.	101451	Ref. No.	—
	union nut	thread M16x1.5 tube ø 8mm		

gas valves and ignition boxes

gas control valves

HONEYWELL



Part No.	101395	Ref. No.	43330001	
<b>description</b>	gas valve type VR4605P 230V 50Hz gas inlet 1/2" gas outlet 1/2" thermocouple connection pilot connection pressure range 8-50mbar operator type 230V (V404A 1071) pressure controller type 220/240V (V404A 1071 4) HONEYWELL coil type 220/240V (V4336A 2220) flange 45x45mm			
<b>accessories for</b>		101395		
	Part No.	101320	Ref. No.	—
	cover	suitable for gas valves HONEYWELL		
	Part No.	102845	Ref. No.	—
	gas connection	angled 1/2" flange 32x32mm hole distance 24x24mm Tandem		
	Part No.	102846	Ref. No.	—
	gas connection	straight 1/2" flange 32x32mm hole distance 24x24mm suitable for Tandem		

SIT

ELETTROSIT



Part No.	101127	Ref. No.	43300012	
<b>description</b>	gas valve SIT type ELETTROSIT 230V gas inlet 3/4" gas outlet 3/4" thermocouple connection M9x1 pilot connection M10x1 lateral equiv. no. 0.810.175			
<b>spare parts for</b>		101127		
	Part No.	101312	Ref. No.	—
	microswitch			

Table continues overleaf







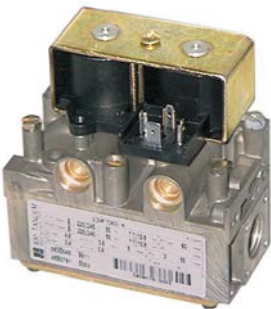



<b>spare parts for</b> 101127	
	Part No. 101352 Ref. No. — solenoid coil 230V 50Hz suitable for ELETTROSIT
<b>accessories for</b> 101127	
	Part No. 100006 Ref. No. — piezoelectric igniter suitable for ELETTROSIT body plastic blowing connection $\varnothing$ 2.4mm $\varnothing$ 14mm
	Part No. 100904 Ref. No. 4392050 locking screw M10x1 for pipe $\varnothing$ 4mm Qty 1 pcs
	Part No. 100905 Ref. No. — locking screw M10x1 for pipe $\varnothing$ 6mm Qty 1 pcs
	Part No. 101301 Ref. No. — gas connection thread 1/2" straight ELETTROSIT screw with O-ring
	Part No. 101303 Ref. No. — gas connection straight thread 3/4" ELETTROSIT
	Part No. 101309 Ref. No. — extension

## TANDEM



1

<b>Part No.</b>	101189	<b>Ref. No.</b>	433012
<b>description</b>	gas valve 230V 50Hz gas inlet 1/2" gas outlet 1/2" pilot connection M10x1 level slow ignition ignition times pressure range 3-50mbar power supply for modulator equiv. no. 0.830.040 suitable for Tandem		
<b>For models:</b>	700-622, 700-900, 900-622, 900-642, 900-900, 900-940, 920-622, 920-642, 920-900, 920-940		
<b>spare parts for</b> 101189			
	Part No. 101379	Ref. No.	—
solenoid coil 230V 50Hz suitable for Tandem			
<b>accessories for</b> 101189			
	Part No. 100904	Ref. No.	4392050
locking screw M10x1 for pipe $\varnothing$ 4mm Qty 1 pcs			
	Part No. 100905	Ref. No.	—
locking screw M10x1 for pipe $\varnothing$ 6mm Qty 1 pcs			
	Part No. 101274	Ref. No.	—
olive for pipe $\varnothing$ 16mm Qty 1 pcs			
	Part No. 101275	Ref. No.	—
union screw thread 1/2" for pipe $\varnothing$ 16mm Qty 1 pcs			
	Part No. 101925	Ref. No.	—
plug with O-ring thread M10x1 for pilot burner suitable for NOVASIT			

<b>accessories for</b> 101189	
	Part No. 102845 Ref. No. — gas connection angled 1/2" flange 32x32mm hole distance 24x24mm Tandem
	Part No. 102846 Ref. No. — gas connection straight 1/2" flange 32x32mm hole distance 24x24mm suitable for Tandem
	Part No. 102847 Ref. No. — O-ring

## ignition boxes

### HONEYWELL



1

<b>Part No.</b>	101165	<b>Ref. No.</b>	43331001
<b>description</b>	ignition box HONEYWELL type S4560A 1008 equiv. no. S4560A 1008 electrodes 1 waiting time 0s safety time 10s 220-240V 10VA 50Hz		
<b>For models:</b>	700-622, 700-900, 900-622, 900-642, 900-900, 900-940, 920-622, 920-642, 920-900, 920-940		
<b>spare parts for</b> 101165			
	Part No. 358696	Ref. No.	—
fine fuse size $\varnothing$ 5x20mm 4A medium lag rated 250V Qty 10 pcs			



1

<b>Part No.</b>	102367	<b>Ref. No.</b>	293203200
<b>description</b>	ignition box HONEYWELL type S4565A 2092 1 electrodes 3 waiting times safety time 10s 220-240V 4VA 50/60Hz		



1

<b>Part No.</b>	106949	<b>Ref. No.</b>	43331002
<b>description</b>	ignition box HONEYWELL type S4960A 1008 electrodes 1 waiting time 2s safety time 10s 220-240V 10VA 50Hz		





# ignition parts











## pilot burners







### SIT

#### 100 series



1

<b>Part No.</b>	106906	<b>Ref. No.</b>	A00132 A00280
<b>description</b>	pilot burner SIT type 100 series 3 flames nozzle $\varnothing$ 0.2mm gas connection 6mm		
<b>For models:</b>	110-120AL-ALR, 110-120TL-TLR, 110-122AL-ALR, 110-122ALC, 110-122FELC, 110-122FEL-FELR, 110-122FLC, 110-122FL-FLR, 110-122TL, 110-122TL-TLR, 500-120AL-AR, 500-120ALC, 500-120TLC, 500-120TLTR, 500-122AL-ALR-AR, 500-122ALC, 500-122TLC, 500-122TL-TLR TR, 64-120TLC, 64-120TL-TR, 64-122TL, 64-122TLC, 64-122TLR-TR, 64-130TL-TR, 64-132TL-TLR-TR, 64-600T-603T, 700-120AL-AR-CL, 700-120ALC-CLC, 700-120CR-TL, 700-120TLC, 700-120TR, 700-122AL, 700-122ALC, 700-122ALR-AR-CL, 700-122CLC, 700-122CLR-CR TL, 700-122TLC, 700-122TLR-TR, 700-130AL-AR, 700-130CL-CR, 700-130TL-TR, 700-132AL-AR, 700-132ALR, 700-132CL-CR, 700-132CLR, 700-132TLR, 700-132TL-TR, 700-138A-C-T, 700-138FBA, 700-138FEBA... (Other models you can see in the webshop)		
<b>spare parts for</b>	106906		
	<b>Part No.</b>	100245	<b>Ref. No.</b> 4370001
	pilot burner nozzle LPG code 20 bore $\varnothing$ 0.2mm Qty 1 pcs thread M8x0.75		
	<b>Part No.</b>	100855	<b>Ref. No.</b> —
	pilot burner bracket triple		
	<b>Part No.</b>	100885	<b>Ref. No.</b> —
	air mixing sleeve for pilot burner Qty 1 pcs		
	<b>Part No.</b>	100916	<b>Ref. No.</b> —
	compression spring for pilot burner Qty 1 pcs		
	<b>Part No.</b>	100917	<b>Ref. No.</b> —
	gasket for pilot burner Qty 1 pcs aluminium		
	<b>Part No.</b>	100918	<b>Ref. No.</b> —
	screw for pilot burner		
	<b>Part No.</b>	107162	<b>Ref. No.</b> —
	pilot burner cap SIT 3 flames Hmm Lmm Qty 1 pcs		
	<b>Part No.</b>	107701	<b>Ref. No.</b> —
	pilot burner bottom part SIT 100 series nozzle $\varnothing$ 0.2mm		
<b>accessories for</b>	106906		
	<b>Part No.</b>	100245	<b>Ref. No.</b> 4370001
	pilot burner nozzle LPG code 20 bore $\varnothing$ 0.2mm Qty 1 pcs thread M8x0.75		
	<b>Part No.</b>	100246	<b>Ref. No.</b> —
	pilot burner nozzle natural gas bore $\varnothing$ 0.35mm Qty 1 pcs thread M8x0.75		
	<b>Part No.</b>	100904	<b>Ref. No.</b> 4392050
	locking screw M10x1 for pipe $\varnothing$ 4mm Qty 1 pcs		

<b>accessories for</b>	106906		
	<b>Part No.</b>	100905	<b>Ref. No.</b> —
	locking screw M10x1 for pipe $\varnothing$ 6mm Qty 1 pcs		
	<b>Part No.</b>	102110	<b>Ref. No.</b> —
	pilot tube copper pipe $\varnothing$ 4mm thickness 1mm L 3000mm		
	<b>Part No.</b>	102111	<b>Ref. No.</b> —
	pilot tube copper pipe $\varnothing$ 6mm thickness 1mm L 3000mm		
	<b>Part No.</b>	107171	<b>Ref. No.</b> —
	pilot burner nozzle SIT natural/liquid gas bore $\varnothing$ 0.25mm Qty 1 pcs		
	<b>Part No.</b>	107700	<b>Ref. No.</b> —
	pilot burner bottom part SIT 100 series nozzle $\varnothing$ 0.25mm		
	<b>Part No.</b>	107702	<b>Ref. No.</b> —
	pilot burner bottom part SIT 100 series nozzle $\varnothing$ 0.35mm		

### accessories

#### pilot burner nozzles



1

<b>Part No.</b>	100245	<b>Ref. No.</b>	4370001
<b>description</b>	pilot burner nozzle LPG code 20 bore $\varnothing$ 0.2mm Qty 1 pcs thread M8x0.75		

### ignition electrodes

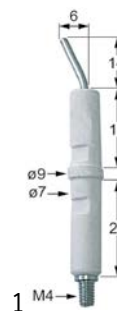





<b>Part No.</b>	100706	<b>Ref. No.</b>	4398070
<b>description</b>	ignition electrode connection M4 Qty 1 pcs		
<b>For models:</b>	110-120AL-ALR, 110-120TL-TLR, 110-122AL-ALR, 110-122ALC, 110-122FELC, 110-122FEL-FELR, 110-122FLC, 110-122FL-FLR, 110-122TL, 110-122TL-TLR, 500-120AL-AR, 500-120ALC, 500-120TLC, 500-120TLTR, 500-122AL-ALR-AR, 500-122ALC, 500-122TLC, 500-122TL-TLR TR, 64-120TLC, 64-120TL-TR, 64-122TL, 64-122TLC, 64-122TLR-TR, 64-130TL-TR, 64-132TL-TLR-TR, 64-600T-603T, 700-120AL-AR-CL, 700-120ALC-CLC, 700-120CR-TL, 700-120TLC, 700-120TR, 700-122AL, 700-122ALC, 700-122ALR-AR-CL, 700-122CLC, 700-122CLR-CR TL, 700-122TLC, 700-122TLR-TR, 700-130AL-AR, 700-130CL-CR, 700-130TL-TR, 700-132AL-AR, 700-132ALR, 700-132CL-CR, 700-132CLR, 700-132TLR, 700-132TL-TR, 700-138A-C-T, 700-138FBA, 700-138FEBA... (Other models you can see in the webshop)		





140 - 145 -150 series

















<b>Part No.</b>	100159	<b>Ref. No.</b>	790200900
<b>description</b>	pilot burner SIT type 150 series 2 flames nozzle 19 nozzle ø 0.23/0.26mm gas connection 4mm		
<b>spare parts for</b>	100159		
	<b>Part No.</b>	100205	<b>Ref. No.</b> 43702019
	pilot burner nozzle SIT LPG code 19 bore ø 0.23/0.26mm Qty 1 pcs suitable for SIT 150 series		
	<b>Part No.</b>	100701	<b>Ref. No.</b> 270200700
	ignition electrode connection M4 Qty 1 pcs		
	<b>Part No.</b>	100897	<b>Ref. No.</b> —
	olive for pipe ø 4mm Qty 1 pcs for pilot burner		
	<b>Part No.</b>	100906	<b>Ref. No.</b> —
	screw connection thread M10x1 for ignition electrode brass Qty 1 pcs WS 10		
	<b>Part No.</b>	100907	<b>Ref. No.</b> —
	screw connection thread M10x1 Qty 1 pcs type SEF 1 ømm for thermocouple		
	<b>Part No.</b>	100908	<b>Ref. No.</b> —
	union screw thread M10x1 for pipe ø 4mm Qty 1 pcs		
	<b>Part No.</b>	107888	<b>Ref. No.</b> —
	pilot burner SIT type 150 series 2 flames		
<b>accessories for</b>	100159		
	<b>Part No.</b>	100204	<b>Ref. No.</b> —
	pilot burner nozzle SIT LPG code 14 bore ø 0.18/0.20mm Qty 1 pcs suitable for 140 series		
	<b>Part No.</b>	100206	<b>Ref. No.</b> 43702036
	pilot burner nozzle SIT natural gas code 36 bore ø 0.60/0.55mm Qty 1 pcs suitable for SIT 150 series		
	<b>Part No.</b>	100207	<b>Ref. No.</b> —
	pilot burner nozzle SIT natural gas code 27 bore ø 0.40/0.38mm suitable for SIT 140 series		
	<b>Part No.</b>	100216	<b>Ref. No.</b> —
	pilot burner nozzle SIT natural gas code 38 bore ø 0.45mm Qty 1 pcs suitable for SIT 150 series		
	<b>Part No.</b>	100898	<b>Ref. No.</b> —
	olive for pipe ø 6mm Qty 1 pcs for pilot burner		
	<b>Part No.</b>	100909	<b>Ref. No.</b> —
	union screw thread M10x1 for pipe ø 6mm Qty 1 pcs		

















<b>Part No.</b>	106942	<b>Ref. No.</b>	A00407
<b>description</b>	pilot burner type 150 series 1 flame nozzle ømm gas connectionmm		
<b>For models:</b>	700-020A-C-T, 700-040A-C-T, 700-040FB, 700-040FEB, 700-138A-C-T, 700-138FBA, 700-138FEBA, 700-162A-C-T, 700-162FBA, 700-162FEBA, 700-162FG, 900-020A-C-T, 900-040A-C-T, 900-040F, 900-040FE, 900-138A-C-T, 900-138FA, 900-138FEA, 900-162A-C-T, 900-162FA, 900-162FEA, 900-162FG, 900-182F, 900-182FE, 900-302		
<b>spare parts for</b>	106942		
	<b>Part No.</b>	100907	<b>Ref. No.</b> —
	screw connection thread M10x1 Qty 1 pcs type SEF 1 ømm for thermocouple		
<b>accessories for</b>	106942		
	<b>Part No.</b>	100204	<b>Ref. No.</b> —
	pilot burner nozzle SIT LPG code 14 bore ø 0.18/0.20mm Qty 1 pcs suitable for 140 series		
	<b>Part No.</b>	100205	<b>Ref. No.</b> 43702019
	pilot burner nozzle SIT LPG code 19 bore ø 0.23/0.26mm Qty 1 pcs suitable for SIT 150 series		
	<b>Part No.</b>	100206	<b>Ref. No.</b> 43702036
	pilot burner nozzle SIT natural gas code 36 bore ø 0.60/0.55mm Qty 1 pcs suitable for SIT 150 series		
	<b>Part No.</b>	100207	<b>Ref. No.</b> —
	pilot burner nozzle SIT natural gas code 27 bore ø 0.40/0.38mm suitable for SIT 140 series		
	<b>Part No.</b>	100216	<b>Ref. No.</b> —
	pilot burner nozzle SIT natural gas code 38 bore ø 0.45mm Qty 1 pcs suitable for SIT 150 series		
	<b>Part No.</b>	100701	<b>Ref. No.</b> 270200700
	ignition electrode connection M4 Qty 1 pcs		
	<b>Part No.</b>	100897	<b>Ref. No.</b> —
	olive for pipe ø 4mm Qty 1 pcs for pilot burner		
	<b>Part No.</b>	100898	<b>Ref. No.</b> —
	olive for pipe ø 6mm Qty 1 pcs for pilot burner		
	<b>Part No.</b>	100906	<b>Ref. No.</b> —
	screw connection thread M10x1 for ignition electrode brass Qty 1 pcs WS 10		
	<b>Part No.</b>	100908	<b>Ref. No.</b> —
	union screw thread M10x1 for pipe ø 4mm Qty 1 pcs		
	<b>Part No.</b>	100909	<b>Ref. No.</b> —
	union screw thread M10x1 for pipe ø 6mm Qty 1 pcs		



160 series

			
1			
<b>Part No.</b>	100054	<b>Ref. No.</b>	A00281
<b>description</b>	pilot burner SIT type 160 series 2 flames nozzle $\varnothing$ mm gas connectionmm		
<b>For models:</b>	110-200A-T, 110-200F, 110-200FE		
<b>spare parts for</b>	100054		
	<b>Part No.</b>	100907	<b>Ref. No.</b> —
	screw connection thread M10x1 Qty 1 pcs type SEF 1 $\varnothing$ mm for thermocouple		
<b>accessories for</b>	100054		
	<b>Part No.</b>	100202	<b>Ref. No.</b> —
	pilot burner nozzle natural gas code 41 Qty 1 pcs nozzle $\varnothing$ 0.41mm		
	<b>Part No.</b>	100203	<b>Ref. No.</b> —
	pilot burner nozzle LPG code 25 Qty 1 pcs nozzle $\varnothing$ 0.25mm		
	<b>Part No.</b>	100701	<b>Ref. No.</b> 270200700
	ignition electrode connection M4 Qty 1 pcs		
	<b>Part No.</b>	100801	<b>Ref. No.</b> —
	gasket for pilot burner Qty 1 pcs		
	<b>Part No.</b>	100869	<b>Ref. No.</b> —
	pilot burner nozzle natural gas code 51 Qty 1 pcs suitable for 160 series nozzle $\varnothing$ 0.51mm		
	<b>Part No.</b>	100906	<b>Ref. No.</b> —
	screw connection thread M10x1 for ignition electrode brass Qty 1 pcs WS 10		
	<b>Part No.</b>	100908	<b>Ref. No.</b> —
	union screw thread M10x1 for pipe $\varnothing$ 4mm Qty 1 pcs		
	<b>Part No.</b>	100909	<b>Ref. No.</b> —
	union screw thread M10x1 for pipe $\varnothing$ 6mm Qty 1 pcs		
	<b>Part No.</b>	101282	<b>Ref. No.</b> —
	olive for pipe $\varnothing$ 4mm L 7.4mm Qty 1 pcs		
	<b>Part No.</b>	101287	<b>Ref. No.</b> —
	olive for pipe $\varnothing$ 6mm Qty 1 pcs		
	<b>Part No.</b>	102110	<b>Ref. No.</b> —
	pilot tube copper pipe $\varnothing$ 4mm thickness 1mm L 3000mm		
	<b>Part No.</b>	102111	<b>Ref. No.</b> —
	pilot tube copper pipe $\varnothing$ 6mm thickness 1mm L 3000mm		
	<b>Part No.</b>	107650	<b>Ref. No.</b> 43703030
	pilot burner nozzle SIT LPG code 30 Qty 1 pcs		

			
1			
<b>Part No.</b>	100056	<b>Ref. No.</b>	A00282
<b>description</b>	pilot burner SIT type 160 series 3 flames nozzle $\varnothing$ mm gas connectionmm		
<b>spare parts for</b>	100056		
	<b>Part No.</b>	100907	<b>Ref. No.</b> —
	screw connection thread M10x1 Qty 1 pcs type SEF 1 $\varnothing$ mm for thermocouple		
<b>accessories for</b>	100056		
	<b>Part No.</b>	100202	<b>Ref. No.</b> —
	pilot burner nozzle natural gas code 41 Qty 1 pcs nozzle $\varnothing$ 0.41mm		
	<b>Part No.</b>	100203	<b>Ref. No.</b> —
	pilot burner nozzle LPG code 25 Qty 1 pcs nozzle $\varnothing$ 0.25mm		
	<b>Part No.</b>	100701	<b>Ref. No.</b> 270200700
	ignition electrode connection M4 Qty 1 pcs		
	<b>Part No.</b>	100801	<b>Ref. No.</b> —
	gasket for pilot burner Qty 1 pcs		
	<b>Part No.</b>	100869	<b>Ref. No.</b> —
	pilot burner nozzle natural gas code 51 Qty 1 pcs suitable for 160 series nozzle $\varnothing$ 0.51mm		
	<b>Part No.</b>	100870	<b>Ref. No.</b> —
	olive for pipe $\varnothing$ 4mm Qty 1 pcs suitable for 160 series for pilot burner		
	<b>Part No.</b>	100906	<b>Ref. No.</b> —
	screw connection thread M10x1 for ignition electrode brass Qty 1 pcs WS 10		
	<b>Part No.</b>	100908	<b>Ref. No.</b> —
	union screw thread M10x1 for pipe $\varnothing$ 4mm Qty 1 pcs		
	<b>Part No.</b>	100909	<b>Ref. No.</b> —
	union screw thread M10x1 for pipe $\varnothing$ 6mm Qty 1 pcs		
	<b>Part No.</b>	101287	<b>Ref. No.</b> —
	olive for pipe $\varnothing$ 6mm Qty 1 pcs		
	<b>Part No.</b>	102110	<b>Ref. No.</b> —
	pilot tube copper pipe $\varnothing$ 4mm thickness 1mm L 3000mm		
	<b>Part No.</b>	102111	<b>Ref. No.</b> —
	pilot tube copper pipe $\varnothing$ 6mm thickness 1mm L 3000mm		
	<b>Part No.</b>	107650	<b>Ref. No.</b> 43703030
	pilot burner nozzle SIT LPG code 30 Qty 1 pcs		



**POLIDORO**

pilot burners







<b>Part No.</b>	102295	<b>Ref. No.</b>	436201 526FSUF4
<b>description</b>	pilot burner POLIDORO 3 flames code gas connection 4mm		
<b>spare parts for</b>	102295		
	<b>Part No.</b>	100907	<b>Ref. No.</b> —
	screw connection thread M10x1 Qty 1 pcs type SEF 1 ømm for thermocouple		
<b>accessories for</b>	102295		
	<b>Part No.</b>	100208	<b>Ref. No.</b> 4372022
	pilot burner nozzle POLIDORO LPG code 20 bore ø 0.2mm Qty 1 pcs		
	<b>Part No.</b>	100209	<b>Ref. No.</b> —
	pilot burner nozzle POLIDORO natural gas code 40 bore ø 0.4mm Qty 1 pcs		
	<b>Part No.</b>	100701	<b>Ref. No.</b> 270200700
	ignition electrode connection M4 Qty 1 pcs		
	<b>Part No.</b>	100906	<b>Ref. No.</b> —
	screw connection thread M10x1 for ignition electrode brass Qty 1 pcs WS 10		
	<b>Part No.</b>	100908	<b>Ref. No.</b> —
	union screw thread M10x1 for pipe ø 4mm Qty 1 pcs		
	<b>Part No.</b>	100909	<b>Ref. No.</b> —
	union screw thread M10x1 for pipe ø 6mm Qty 1 pcs		
	<b>Part No.</b>	101280	<b>Ref. No.</b> —
	olive for pipe ø 4mm Qty 1 pcs		
	<b>Part No.</b>	101287	<b>Ref. No.</b> —
	olive for pipe ø 6mm Qty 1 pcs		
	<b>Part No.</b>	102110	<b>Ref. No.</b> —
	pilot tube copper pipe ø 4mm thickness 1mm L 3000mm		
	<b>Part No.</b>	102111	<b>Ref. No.</b> —
	pilot tube copper pipe ø 6mm thickness 1mm L 3000mm		





<b>Part No.</b>	100076	<b>Ref. No.</b>	A00283
<b>description</b>	pilot burner POLIDORO 3 flames natural gas code 29.2 gas connection 6mm		
<b>For models:</b>	110-122FLC, 110-122FL-FLR, 500-125A-126A, 500-750A, 500-800A, 64-040FCE, 64-040F-FV, 64-125T-126T, 64-222F, 64-900T, 700-040FB, 700-125A-C, 700-125T, 700-126A-C, 700-126T, 700-127A-C, 700-127T, 700-138FBA, 700-162FBA, 700-162FG, 700-200FB, 700-222FB, 700-224FBA, 700-224FG, 700-508, 700-750A-S, 700-800A-S, 900-040F, 900-125A-C, 900-125T, 900-126A-C, 900-126T, 900-127A-C, 900-127T, 900-138FA, 900-162FA, 900-162FG, 900-200F, 900-503, 900-506, 900-750A-S, 900-800A-S, 920-122FLC, 920-122FL-FLR-FR, 920-200F, 920-503, 920-506, 920-750A-S		
<b>accessories for</b>	100076		
	<b>Part No.</b>	100000	<b>Ref. No.</b> —
	pilot burner nozzle POLIDORO LPG code 22 bore ø 0.22mm Qty 1 pcs		
	<b>Part No.</b>	100208	<b>Ref. No.</b> 4372022
	pilot burner nozzle POLIDORO LPG code 20 bore ø 0.2mm Qty 1 pcs		
	<b>Part No.</b>	100209	<b>Ref. No.</b> —
	pilot burner nozzle POLIDORO natural gas code 40 bore ø 0.4mm Qty 1 pcs		
	<b>Part No.</b>	100701	<b>Ref. No.</b> 270200700
	ignition electrode connection M4 Qty 1 pcs		
	<b>Part No.</b>	100906	<b>Ref. No.</b> —
	screw connection thread M10x1 for ignition electrode brass Qty 1 pcs WS 10		
	<b>Part No.</b>	100907	<b>Ref. No.</b> —
	screw connection thread M10x1 Qty 1 pcs type SEF 1 ømm for thermocouple		
	<b>Part No.</b>	100908	<b>Ref. No.</b> —
	union screw thread M10x1 for pipe ø 4mm Qty 1 pcs		
	<b>Part No.</b>	100909	<b>Ref. No.</b> —
	union screw thread M10x1 for pipe ø 6mm Qty 1 pcs		
	<b>Part No.</b>	102110	<b>Ref. No.</b> —
	pilot tube copper pipe ø 4mm thickness 1mm L 3000mm		
	<b>Part No.</b>	102111	<b>Ref. No.</b> —
	pilot tube copper pipe ø 6mm thickness 1mm L 3000mm		
	<b>Part No.</b>	102508	<b>Ref. No.</b> —
	union screw thread M10x1 for pipe ø 4mm Qty 5 pcs		
	<b>Part No.</b>	102509	<b>Ref. No.</b> —
	union screw thread M10x1 for pipe ø 6mm Qty 5 pcs		
	<b>Part No.</b>	102699	<b>Ref. No.</b> —
	pilot burner nozzle POLIDORO natural gas code 25.2 bore ø 2x0.25mm Qty 1 pcs 2 bores		
	<b>Part No.</b>	102795	<b>Ref. No.</b> —
	olive for pipe ø 4mm Qty 1 pcs		
	<b>Part No.</b>	102797	<b>Ref. No.</b> —
	olive for pipe ø 6mm Qty 1 pcs		

Table continues overleaf



accessories for		100076	
Part No.	106703	Ref. No.	—
	pilot burner nozzle POLIDORO natural gas code 27.2 bore ø 2x0.27mm Qty 1 pcs		
Part No.	106704	Ref. No.	—
	pilot burner nozzle POLIDORO LPG code 16.2 bore ø 2x0.16mm Qty 1 pcs		
Part No.	106763	Ref. No.	4372027
	pilot burner nozzle POLIDORO natural gas code 27.2A bore ø 2x 0.27mm Qty 1 pcs		
Part No.	106859	Ref. No.	—
	pilot burner nozzle POLIDORO LPG code 24 bore ø 0.24mm Qty 1 pcs		

accessories for		100165	
Part No.	101282	Ref. No.	—
	olive for pipe ø 4mm L 7.4mm Qty 1 pcs		
Part No.	101287	Ref. No.	—
	olive for pipe ø 6mm Qty 1 pcs		
Part No.	107650	Ref. No.	43703030
	pilot burner nozzle SIT LPG code 30 Qty 1 pcs		

PRO-GAS

140 - 145 -150 series

pilot burners



1

Part No.	102804	Ref. No.	A00424
<b>description</b> pilot burner type 150 series 1 flame			
<b>For models:</b> 500-601A, 64-222F, 64-222FCE, 64-222FE, 64-222T, 700-222A-C, 700-222FB, 700-222FEB, 700-222T, 700-224A-C, 700-224FBA, 700-224FEBA, 700-224FG, 700-224T, 700-601A-S, 700-602A-S, 700-603A, 700-604A-605A, 900-601A-S, 900-602A-S, 900-604A-S, 900-605A-S, 920-604A-S			





producer-specific pilot burners

GICO

50 / 60 / 62 / 70 / 90 / 92 / 110 series (version 1)



1

Part No.	100165	Ref. No.	270200020
<b>description</b> pilot burner			
accessories for		100165	
Part No.	100202	Ref. No.	—
	pilot burner nozzle natural gas code 41 Qty 1 pcs nozzle ø 0.41mm		
Part No.	100203	Ref. No.	—
	pilot burner nozzle LPG code 25 Qty 1 pcs nozzle ø 0.25mm		
Part No.	100908	Ref. No.	—
	union screw thread M10x1 for pipe ø 4mm Qty 1 pcs		
Part No.	100909	Ref. No.	—
	union screw thread M10x1 for pipe ø 6mm Qty 1 pcs		



1

Part No.	100068	Ref. No.	270200020 A00001
<b>description</b> pilot burner 2 flames gas connection 6mm			
accessories for		100068	
Part No.	100202	Ref. No.	—
	pilot burner nozzle natural gas code 41 Qty 1 pcs nozzle ø 0.41mm		
Part No.	100203	Ref. No.	—
	pilot burner nozzle LPG code 25 Qty 1 pcs nozzle ø 0.25mm		
Part No.	100908	Ref. No.	—
	union screw thread M10x1 for pipe ø 4mm Qty 1 pcs		
Part No.	100909	Ref. No.	—
	union screw thread M10x1 for pipe ø 6mm Qty 1 pcs		
Part No.	101282	Ref. No.	—
	olive for pipe ø 4mm L 7.4mm Qty 1 pcs		
Part No.	101287	Ref. No.	—
	olive for pipe ø 6mm Qty 1 pcs		
Part No.	107649	Ref. No.	—
	pilot burner nozzle SIT LPG code 20 Qty 1 pcs		
Part No.	107650	Ref. No.	43703030
	pilot burner nozzle SIT LPG code 30 Qty 1 pcs		



electrodes

1 gas components

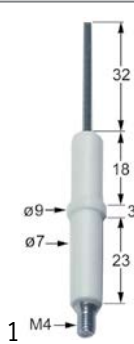

<b>Part No.</b>	100701	<b>Ref. No.</b>	270200700
<b>description</b>	ignition electrode connection M4 Qty 1 pcs		
<b>For models:</b>	110-122FLC, 110-122FL-FLR, 110-200A-T, 110-200F, 110-200FE, 500-125A-126A, 500-750A, 500-800A, 64-040F-FV, 64-125T-126T, 64-222F, 700-040FB, 700-125A-C, 700-125T, 700-126A-C, 700-126T, 700-127A-C, 700-127T, 700-162FBA, 700-162FG, 700-508, 700-750A-S, 700-800A-S, 900-040F, 900-125A-C, 900-125T, 900-126A-C, 900-126T, 900-127A-C, 900-127T, 900-162FA, 900-162FG, 900-182F, 900-503, 900-506, 900-750A-S, 900-800A-S, 920-122FLC, 920-122FL-FLR-FR, 920-503, 920-506, 920-750A-S		
<b>accessories for</b>	100701		
	<b>Part No.</b>	100906	<b>Ref. No.</b> —
	screw connection thread M10x1 for ignition electrode brass Qty 1 pcs WS 10		



<b>Part No.</b>	100706	<b>Ref. No.</b>	4398070
<b>description</b>	ignition electrode connection M4 Qty 1 pcs		
<b>For models:</b>	110-120AL-ALR, 110-120TL-TLR, 110-122AL-ALR, 110-122ALC, 110-122FELC, 110-122FEL-FELR, 110-122FLC, 110-122FL-FLR, 110-122TL, 110-122TL-TLR, 500-120AL-AR, 500-120ALC, 500-120TLC, 500-120TLTR, 500-122AL-ALR-AR, 500-122ALC, 500-122TLC, 500-122TL-TLR TR, 64-120TLC, 64-120TL-TR, 64-122TL, 64-122TLC, 64-122TLR-TR, 64-130TL-TR, 64-132TL-TLR-TR, 64-600T-603T, 700-120AL-AR-CL, 700-120ALC-CLC, 700-120CR-TL, 700-120TLC, 700-120TR, 700-122AL, 700-122ALC, 700-122ALR-AR-CL, 700-122CLC, 700-122CLR-CR TL, 700-122TLC, 700-122TLR-TR, 700-130AL-AR, 700-130CL-CR, 700-130TL-TR, 700-132AL-AR, 700-132ALR, 700-132CL-CR, 700-132CLR, 700-132TLR, 700-132TL-TR, 700-138A-C-T, 700-138FBA, 700-138FEBA... (Other models you can see in the webshop)		

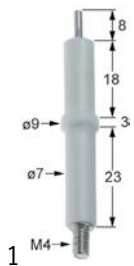

<b>Part No.</b>	102871	<b>Ref. No.</b>	4398060
<b>description</b>	ignition electrode D1 ø 7mm D2 ø 9mm connection M4 L1 8mm BL1 18mm BL2 3mm BL3 23mm to clip		
<b>For models:</b>	500-601A, 64-222F, 64-222FCE, 64-222FE, 64-222T, 700-222A-C, 700-222FB, 700-222FEB, 700-222T, 700-224A-C, 700-224FBA, 700-224FEBA, 700-224FG, 700-224T, 700-601A-S, 700-602A-S, 700-603A, 700-604A-605A, 700-609A, 900-601A-S, 900-602A-S, 900-604A-S, 900-605A-S, 900-609A, 920-604A-S, 920-609A		

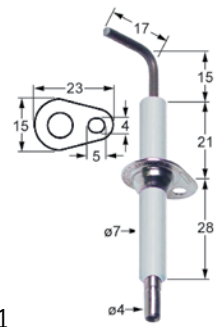

<b>Part No.</b>	100761	<b>Ref. No.</b>	793305370
<b>description</b>	ignition electrode flange length 23mm flange width 15mm D1 ø 7mm L1 15mm L2 17mm BL1 21mm BL2 28mm fixing dimensions ø5x4mm with flange connection ø 4mm		

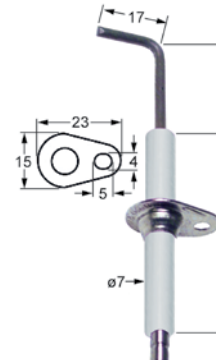

<b>Part No.</b>	100760	<b>Ref. No.</b>	793305360
<b>description</b>	ignition electrode flange length 23mm flange width 15mm D1 ø 7mm L1 26mm L2 17mm BL1 21mm BL2 28mm fixing dimensions ø5x4mm with flange connection ø 4mm		

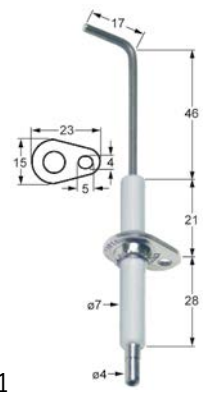

<b>Part No.</b>	100796	<b>Ref. No.</b>	792311420
<b>description</b>	ignition electrode flange length 23mm flange width 15mm D1 ø 7mm L1 46mm L2 17mm BL1 21mm BL2 28mm fixing dimensions ø5x4mm with flange connection ø 4mm		
<b>For models:</b>	700-622, 700-900, 900-622, 900-642, 900-900, 900-940, 920-622, 920-642, 920-900, 920-940		





ignition cables

pre-assembled cables



<b>Part No.</b>	100036	<b>Ref. No.</b>	5509060
<b>description</b>	ignition cable cable length 500mm connection F2.8mm / F2.8mm		
<b>For models:</b>	64-020T-64-040T, 64-040FCE, 64-040FE, 64-040F-FV, 64-222F, 64-222FCE, 64-222FE, 64-222T		



<b>Part No.</b>	100018	<b>Ref. No.</b>	5509040
<b>description</b>	ignition cable cable length 600mm connection ø2.4mm / ø4mm permanent temperature 200°C		
<b>For models:</b>	110-120AL-ALR, 110-120TL-TLR, 110-122AL-ALR, 110-122ALC, 110-122FELC, 110-122FEL-FELR, 110-122FLC, 110-122FL-FLR, 110-122TL, 110-122TL-TLR, 500-120AL-AR, 500-120ALC, 500-120TLC, 500-120TLTR, 500-122AL-ALR-AR, 500-122ALC, 500-122TLC, 500-122TL-TLR TR, 64-120TLC, 64-120TL-TR, 64-122TL, 64-122TLC, 64-122TLR-TR, 64-130TL-TR, 64-132TL-TLR-TR, 64-600T-603T, 64-900T, 700-120ALAR-CL, 700-120ALC-CLC, 700-120CR-TL, 700-120TLC, 700-120TR, 700-122AL, 700-122ALC, 700-122ALR-AR-CL, 700-122CLC, 700-122CLRCR-TL, 700-122TLC, 700-122TLR-TR, 700-130AL-AR, 700-130CL-CR, 700-130TL-TR, 700-132AL-AR, 700-132ALR, 700-132CL-CR, 700-132CLR, 700-132TLR, 700-132TL-TR, 700-400A-C-T, 700-402A-C-T... (Other models you can see in the webshop)		



<b>Part No.</b>	100146	<b>Ref. No.</b>	270112320
<b>description</b>	ignition cable cable length 900mm connection ø2.4mm / lug M4		
<b>For models:</b>	110-122FLC, 110-122FL-FLR, 110-200A-T, 110-200F, 110-200FE, 64-040F-FV, 64-222F, 700-138A-C-T, 700-138FBA, 700-138FEBA, 700-162FBA, 700-162FG, 700-200A-C-T, 700-200FB, 700-200FEB, 700-222FB, 700-224FBA, 700-224FG, 700-401B, 700-508, 900-040F, 900-138A-C-T, 900-138FA, 900-138FEA, 900-162FA, 900-162FG, 900-200A-C-T, 900-200F, 900-200FE, 900-401, 900-503, 900-506, 920-122FLC, 920-122FL-FLR-FR, 920-200A-T, 920-200F, 920-200FE, 920-503, 920-506		



<b>Part No.</b>	100019	<b>Ref. No.</b>	45509080
<b>description</b>	ignition cable cable length 900mm connection ø2.4mm / ø4mm		
<b>For models:</b>	500-601A, 500-750A, 500-800A, 64-040F-FV, 64-125T-126T, 64-222F, 700-222A-C, 700-222FB, 700-222FEB, 700-222T, 700-224A-C, 700-224FBA, 700-224FEBA, 700-224FG, 700-224T, 700-601A-S, 700-602AS, 700-603A, 700-604A-605A, 700-609A, 700-750A-S, 700-800A-S, 900-182F, 900-402A-C-T, 900-601A-S, 900-602A-S, 900-604A-S, 900-605A-S, 900-609A, 900-750A-S, 900-800A-S, 920-402A-T, 920-604A-S, 920-609A, 920-750A-S		

piezoelectric igniters

mounting diameter 22mm



<b>Part No.</b>	100013	<b>Ref. No.</b>	4398050
<b>description</b>	piezoelectric igniter body plastic blowing mounting ø 22mm connection ø2.4mm cable lengthmm		
<b>For models:</b>	64-020T-64-040T, 64-040FCE, 64-040FE, 64-040F-FV, 64-120TLC, 64-120TL-TR, 64-122TL, 64-122TLC, 64-122TLR-TR, 64-125T-126T, 64-130TL-TR, 64-132TL-TLR-TR, 64-222F, 64-222FCE, 64-222FE, 64-222T, 64-600T-603T, 64-900T		

<b>accessories for</b>	100013	<b>Part No.</b>	100023	<b>Ref. No.</b>	—
					female bullet size 2.3mm 0.5-1.5mm <sup>2</sup> CuZn t.max. 125°C Qty 20 pcs



<b>Part No.</b>	102977	<b>Ref. No.</b>	A00477
<b>description</b>	piezoelectric igniter body plastic blowing mounting ø 22mm connection ø2.4mm cable lengthmm with cover cap		
<b>For models:</b>	110-120AL-ALR, 110-120TL-TLR, 110-122AL-ALR, 110-122ALC, 110-122FELC, 110-122FEL-FELR, 110-122FLC, 110-122FL-FLR, 110-122TL, 110-122TL-TLR, 110-200A-T, 110-200F, 110-200FE, 500-120AL-AR, 500-120ALC, 500-120TLC, 500-120TL-TR, 500-122AL-ALR-AR, 500-122ALC, 500-122TLC, 500-122TL-TLR-TR, 500-125A-126A, 500-601A, 500-750A, 500-800A, 700-040FB, 700-120AL-AR-CL, 700-120ALC-CLC, 700-120CR-TL, 700-120TLC, 700-120TR, 700-122AL, 700-122ALC, 700-122ALR-AR-CL, 700-122CLC, 700-122CLRCR-TL, 700-122TLC, 700-122TLR-TR, 700-125A-C, 700-125T, 700-126A-C, 700-126T, 700-127A-C, 700-127T, 700-130AL-AR, 700-130CL-CR, 700-130TL-TR, 700-132AL-AR, 700-132ALR, 700-132CL-CR...(Other models you can see in the webshop)		

miscellaneous



<b>Part No.</b>	nla <sup>1</sup>	<b>Ref. No.</b>	00073
<b>description</b>	piezoelectric igniter body metal connection F6.3x0.8 2 hole fixing ø 22mm		

<sup>1</sup>no longer available



accessories



1			
<b>Part No.</b>	101339	<b>Ref. No.</b>	290204470
<b>description</b>	cover cap for piezoelectric igniter		

ignition units



1			
<b>Part No.</b>	101002	<b>Ref. No.</b>	539613240
<b>description</b>	ignition unit outputs 2 230VAC dimensions 88x23x34mm mounting distance 73mm inlet F6.3x0.8 outlet F2.8x0.8 0.6VA 50/60Hz		

thermocouples

plug-in thermocouples

plug-in thermocouples standard

with barrel socket  $\varnothing 6\text{mm}$

SIT

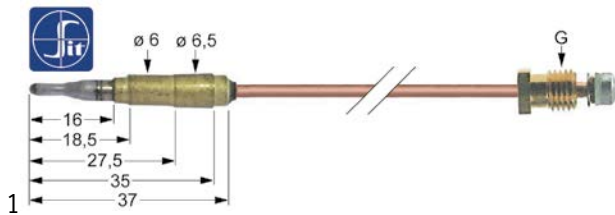

<b>Part No.</b>	102267	<b>Ref. No.</b>	434008085
<b>description</b>	thermocouple M8x1 L 850mm plug connection $\varnothing 6.0\text{mm}$		

with barrel socket  $\varnothing 6(6.5)\text{mm}$

thermocouples SIT

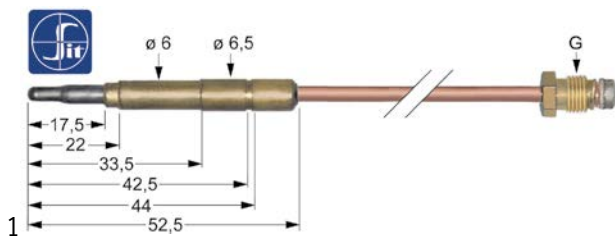

<b>Part No.</b>	107603	<b>Ref. No.</b>	A00426
<b>description</b>	thermocouple SIT M8x1 L 1000mm plug connection $\varnothing 6.0(6.5)\text{mm}$		
<b>For models:</b>	700-020A-C-T, 700-040A-C-T, 700-040FB, 700-040FEB, 700-138A-C-T, 700-138FBA, 700-138FEBA, 700-162A-C-T, 700-162FBA, 700-162FEBA, 700-162FG, 700-222A-C, 700-222FB, 700-222FEB, 700-222T, 700-224A-C, 700-224FBA, 700-224FEBA, 700-224FG, 700-224T, 900-020A-C-T, 900-040A-C-T, 900-040F, 900-040FE, 900-138A-C-T, 900-138FA, 900-138FEA, 900-162A-C-T, 900-162FA, 900-162FEA, 900-162FG, 900-182F, 900-182FE		

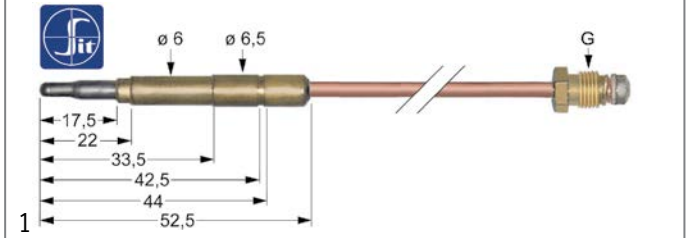

<b>Part No.</b>	107605	<b>Ref. No.</b>	A00201
<b>description</b>	thermocouple SIT M8x1 L 1500mm plug connection $\varnothing 6.0(6.5)\text{mm}$		

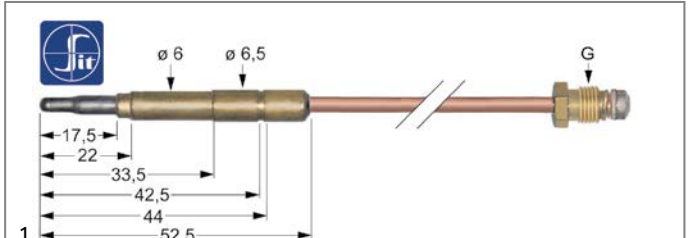

<b>Part No.</b>	107601	<b>Ref. No.</b>	434008050
<b>description</b>	thermocouple SIT M8x1 L 600mm plug connection $\varnothing 6.0(6.5)\text{mm}$		

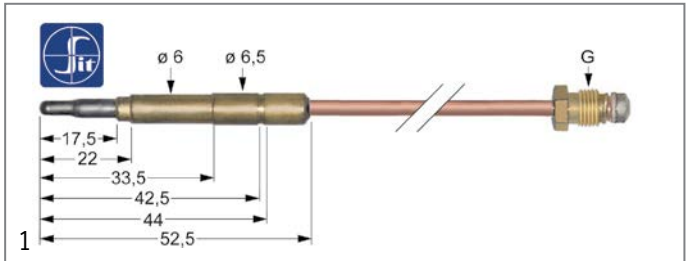

<b>Part No.</b>	107612	<b>Ref. No.</b>	434009110
<b>description</b>	thermocouple SIT M9x1 L 1000mm plug connection $\varnothing 6.0(6.5)\text{mm}$		

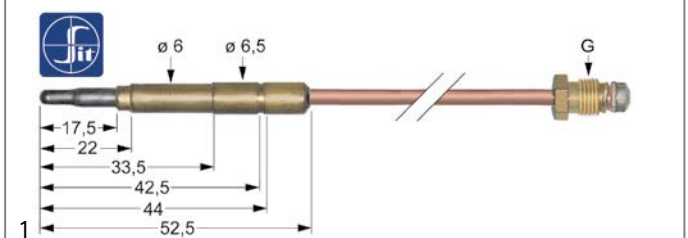

<b>Part No.</b>	107611	<b>Ref. No.</b>	434009175
<b>description</b>	thermocouple SIT M9x1 L 850mm plug connection $\varnothing 6.0(6.5)\text{mm}$		

<b>For models:</b>	110-120AL-ALR, 110-120TL-TLR, 110-122AL-ALR, 110-122ALC, 110-122FELC, 110-122FEL-FELR, 110-122FLC, 110-122FL-FLR, 110-122TL, 110-122TL-TLR, 110-200A-T, 110-200F, 110-200FE, 500-120AL-AR, 500-120ALC, 500-120TLC, 500-120TL-TR, 500-122AL-ALR-AR, 500-122ALC, 500-122TLC, 500-122TL-TLR-TR, 64-040F-FV, 64-125T-126T, 64-222F, 700-040FB, 700-040FEB, 700-120AL-AR-CL, 700-120ALC-CLC, 700-120CR-TL, 700-120TLC, 700-120TR, 700-122AL, 700-122ALC, 700-122ALR-AR-CL, 700-122CLC, 700-122CLR-CR-TL, 700-122TLC, 700-122TLR-TR, 700-138FBA, 700-162FBA, 700-200FB, 700-222FB, 700-224FBA, 700-400A-C-T, 700-401B, 700-402A-C-T, 900-040F, 900-120AL-AR, 900-120ALC, 900-120CL-CR...(Other models you can see in the webshop)		
--------------------	---	--	--



thermocouples with aluminised tip

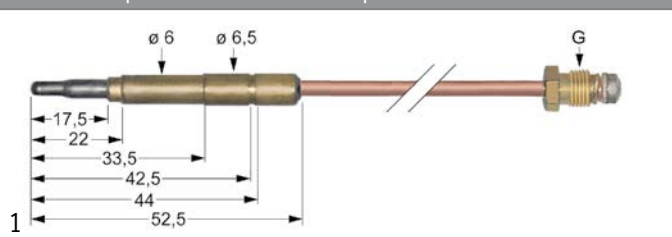

<b>Part No.</b>	102043	<b>Ref. No.</b>	434009000
<b>description</b>	thermocouple M9x1 L 1000mm plug connection ø6.0(6.5)mm		

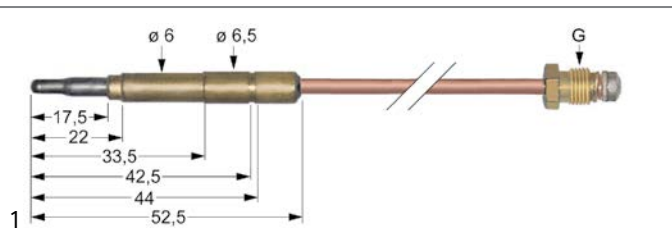

<b>Part No.</b>	102039	<b>Ref. No.</b>	434010100
<b>description</b>	thermocouple M9x1 L 320mm plug connection ø6.0(6.5)mm		

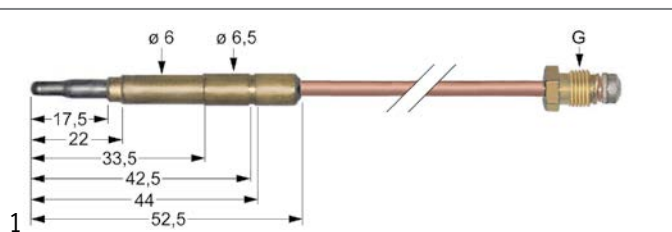

<b>Part No.</b>	102041	<b>Ref. No.</b>	434209075
<b>description</b>	thermocouple M9x1 L 600mm plug connection ø6.0(6.5)mm		

plug-in thermocouples with aluminised tip



<b>Part No.</b>	103058	<b>Ref. No.</b>	434008060
<b>description</b>	thermocouple aluminized tip M8x1 L 600mm plug connection ø6.0(6.5)mm		
<b>For models:</b>	700-020A-C-T, 700-040A-C-T, 700-040FB, 700-040FEB, 700-162A-C-T, 700-162FBA, 700-162FEBA, 700-162FG, 700-222A-C, 700-222FB, 700-222FEB, 700-222T, 700-224A-C, 700-224FBA, 700-224FEBA, 700-224FG, 700-224T, 900-020A-C-T, 900-040A-C-T, 900-040F, 900-040FE, 900-162A-C-T, 900-162FA, 900-162FEA, 900-162FG, 900-182F, 900-182FE		

plug-in thermocouples with interruption

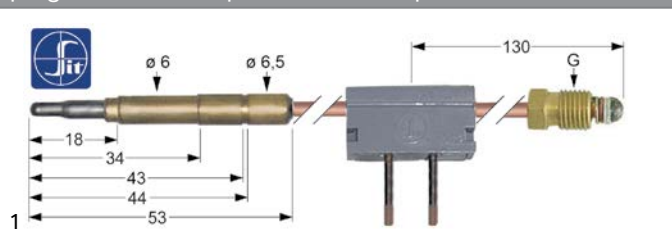

<b>Part No.</b>	107164	<b>Ref. No.</b>	434009100 4343103
<b>description</b>	thermocouple SIT with interrupter M9x1 L 1000mm plug connection ø6.0(6.5)mm soldering connection		
<b>For models:</b>	64-600T-603T, 700-508, 900-503, 900-506, 920-503, 920-506		

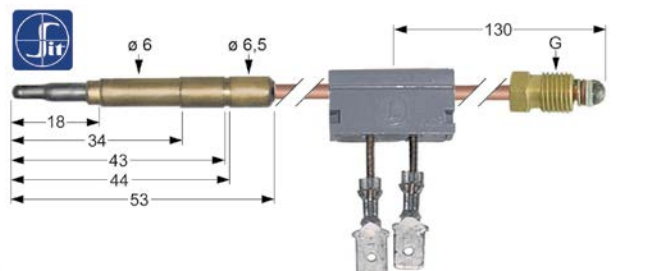

<b>Part No.</b>	107177	<b>Ref. No.</b>	434099045 4343106 A00425
<b>description</b>	thermocouple SIT with interrupter M9x1 L 600mm plug connection ø6.0mm F 6.3mm		
<b>For models:</b>	500-601A, 64-600T-603T, 700-601A-S, 700-602A-S, 700-603A, 700-604A-605A, 700-609A, 900-601A-S, 900-602A-S, 900-604A-S, 900-605A-S, 900-609A, 920-604A-S, 920-609A		

threaded thermocouples

threaded thermocouples standard

with socket with thread M8x1

SIT

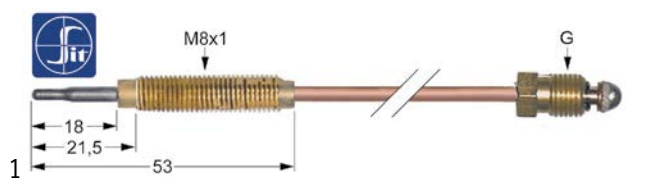

<b>Part No.</b>	107632	<b>Ref. No.</b>	A00270
<b>description</b>	thermocouple SIT M8x1 L 1000mm M8x1		
<b>accessories for</b>	107632		
	<b>Part No.</b>	102067	<b>Ref. No.</b> —
	nut thread M8x1 H 3mm brass Qty 1 pcs type SEF 1		

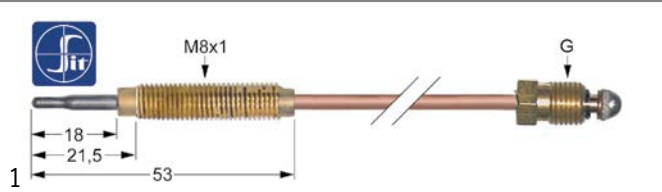

<b>Part No.</b>	107631	<b>Ref. No.</b>	A00017
<b>description</b>	thermocouple SIT M8x1 L 850mm M8x1		
<b>accessories for</b>	107631		
	<b>Part No.</b>	102067	<b>Ref. No.</b> —
	nut thread M8x1 H 3mm brass Qty 1 pcs type SEF 1		



<b>Part No.</b>	107637	<b>Ref. No.</b>	A00022
<b>description</b>	thermocouple SIT M9x1 L 850mm M8x1		
<b>accessories for</b>	107637		
	<b>Part No.</b>	102067	<b>Ref. No.</b> —
	nut thread M8x1 H 3mm brass Qty 1 pcs type SEF 1		

threaded thermocouples (miscellaneous)

<b>Part No.</b>	102055	<b>Ref. No.</b>	A00016
<b>description</b>	thermocouple M8x1 L 450mm M8x1		
<b>For models:</b>	64-020T-64-040T, 64-040FCE, 64-040FE, 64-040F-FV, 64-222F, 64-222FCE, 64-222FE, 64-222T		
<b>accessories for</b>	102055		
	<b>Part No.</b>	102067	<b>Ref. No.</b> —
	nut thread M8x1 H 3mm brass Qty 1 pcs type SEF 1		

thermopiles

<b>Part No.</b>	102116	<b>Ref. No.</b>	434010580
<b>description</b>	thermopile ROBERTSHAW L 900mm probe ø 9mm probe L 57mm 250-750mV screw connection 7/16"		

## gas burners

### hob burners

#### producer-specific hob burners



#### GICO

50, 60, 62, 70, 90, 92, 110 (old series)

<b>Part No.</b>	105068	<b>Ref. No.</b>	741312350
<b>description</b>	air mixing sleeve		
<b>For models:</b>	64-020T-64-040T, 64-040FCE, 64-040FE, 64-040F-FV, 64-222F, 64-222FCE, 64-222FE, 64-222T, 700-020A-C-T, 700-040A-C-T, 700-040FB, 700-040FEB, 700-138A-C-T, 700-138FBA, 700-138FEBA, 700-162A-C-T, 700-162FBA, 700-162FEBA, 700-162FG, 700-222A-C, 700-222FB, 700-222FEB, 700-222T, 700-224A-C, 700-224FBA, 700-224FEBA, 700-224FG, 700-224T, 900-020A-C-T, 900-040A-C-T, 900-040F, 900-040FE, 900-138A-C-T, 900-138FA, 900-138FEA, 900-162A-C-T, 900-162FA, 900-162FEA, 900-162FG, 900-182F, 900-182FE, 900-302		
<b>accessories for</b>	105068		
	<b>Part No.</b>	104091	<b>Ref. No.</b> 790300799
	burner head D ø 124mm for burner cap ø 80mm suitable for 50, 90, 92, 110 series (old)		
	<b>Part No.</b>	104093	<b>Ref. No.</b> 270200170 770324790
	venturi C/D		
	<b>Part No.</b>	104096	<b>Ref. No.</b> 241202412
	burner holder with nozzle holder connection M20x1.5		
	<b>Part No.</b>	105060	<b>Ref. No.</b> 760305080 764305190
	burner head C for burner cap ø 60mm suitable for 60, 62 series		
	<b>Part No.</b>	105062	<b>Ref. No.</b> 760311640
	venturi C		
	<b>Part No.</b>	105076	<b>Ref. No.</b> 790300789
	burner head C for burner cap ø 60mm suitable for 70, 90, 92 series (old)		
	<b>Part No.</b>	105079	<b>Ref. No.</b> 770336760
	burner head D ø 100mm		
	<b>Part No.</b>	105091	<b>Ref. No.</b> 770339300
	burner head C for burner cap ø 60mm		
	<b>Part No.</b>	105098	<b>Ref. No.</b> 770336750
	burner head D for burner cap ø 80mm		
	<b>Part No.</b>	105099	<b>Ref. No.</b> A00419
	burner head A for burner cap ø 110mm		
	<b>Part No.</b>	105100	<b>Ref. No.</b> A00418
	burner head A for burner cap ø 110mm		
	<b>Part No.</b>	105119	<b>Ref. No.</b> A00420
	burner head B for burner cap ø 90mm		
	<b>Part No.</b>	105707	<b>Ref. No.</b> —
	burner cap ø 95mm		

Table continues overleaf



<b>accessories for</b>	105068		
	<b>Part No.</b>	105708	<b>Ref. No.</b> —
	burner head for burner cap ø 95mm		
	<b>Part No.</b>	105709	<b>Ref. No.</b> —
	venturi		
	<b>Part No.</b>	105710	<b>Ref. No.</b> —
	burner holder with nozzle holder		

	1		
<b>Part No.</b>	105078	<b>Ref. No.</b>	290200450
<b>description</b>	burner cap C ø 60mm		
<b>accessories for</b>	105078		
	<b>Part No.</b>	104093	<b>Ref. No.</b> 270200170 770324790
	venturi C/D		
	<b>Part No.</b>	104096	<b>Ref. No.</b> 241202412
	burner holder with nozzle holder connection M20x1.5		
	<b>Part No.</b>	105068	<b>Ref. No.</b> 741312350
	air mixing sleeve		
	<b>Part No.</b>	105076	<b>Ref. No.</b> 790300789
	burner head C for burner cap ø 60mm suitable for 70, 90, 92 series (old)		
	<b>Part No.</b>	105077	<b>Ref. No.</b> 270204230 290200460
	burner ring C for burner cap ø 60mm		
	<b>Part No.</b>	105091	<b>Ref. No.</b> 770339300
	burner head C for burner cap ø 60mm		

	1		
<b>Part No.</b>	105081	<b>Ref. No.</b>	290200480 A00004
<b>description</b>	burner cap D ø 80mm		
<b>accessories for</b>	105081		
	<b>Part No.</b>	104091	<b>Ref. No.</b> 790300799
	burner head D ø 124mm for burner cap ø 80mm suitable for 50, 90, 92, 110 series (old)		
	<b>Part No.</b>	104093	<b>Ref. No.</b> 270200170 770324790
	venturi C/D		
	<b>Part No.</b>	104096	<b>Ref. No.</b> 241202412
	burner holder with nozzle holder connection M20x1.5		
	<b>Part No.</b>	105068	<b>Ref. No.</b> 741312350
	air mixing sleeve		
	<b>Part No.</b>	105080	<b>Ref. No.</b> 270204240
	burner ring D for burner cap ø 80mm		
	<b>Part No.</b>	105098	<b>Ref. No.</b> 770336750
	burner head D for burner cap ø 80mm		

	1		
<b>Part No.</b>	105060	<b>Ref. No.</b>	760305080 764305190
<b>description</b>	burner head C for burner cap ø 60mm suitable for 60, 62 series		
<b>For models:</b>	64-020T-64-040T, 64-040FCE, 64-040FE, 64-040F-FV, 64-222F, 64-222FCE, 64-222FE, 64-222T		
<b>accessories for</b>	105060		
	<b>Part No.</b>	103060	<b>Ref. No.</b> 770319550
	burner cap C ø 70mm		
	<b>Part No.</b>	104096	<b>Ref. No.</b> 241202412
	burner holder with nozzle holder connection M20x1.5		
	<b>Part No.</b>	105062	<b>Ref. No.</b> 760311640
	venturi C		
	<b>Part No.</b>	105068	<b>Ref. No.</b> 741312350
	air mixing sleeve		

	1		
<b>Part No.</b>	105076	<b>Ref. No.</b>	790300789
<b>description</b>	burner head C for burner cap ø 60mm suitable for 70, 90, 92 series (old)		
<b>accessories for</b>	105076		
	<b>Part No.</b>	104093	<b>Ref. No.</b> 270200170 770324790
	venturi C/D		
	<b>Part No.</b>	104096	<b>Ref. No.</b> 241202412
	burner holder with nozzle holder connection M20x1.5		
	<b>Part No.</b>	105068	<b>Ref. No.</b> 741312350
	air mixing sleeve		
	<b>Part No.</b>	105077	<b>Ref. No.</b> 270204230 290200460
	burner ring C for burner cap ø 60mm		
	<b>Part No.</b>	105078	<b>Ref. No.</b> 290200450
	burner cap C ø 60mm		





	1		
<b>Part No.</b>	104091	<b>Ref. No.</b>	790300799
<b>description</b>	burner head D ø 124mm for burner cap ø 80mm suitable for 50, 90, 92, 110 series (old)		
<b>accessories for</b>	104091		
	<b>Part No.</b>	104093	<b>Ref. No.</b> 270200170 770324790
	venturi C/D		



Table continues overleaf









<b>accessories for</b>	104091			
	<b>Part No.</b>	105068	<b>Ref. No.</b>	741312350
	air mixing sleeve			
	<b>Part No.</b>	105080	<b>Ref. No.</b>	270204240
	burner ring D for burner cap ø 80mm			
	<b>Part No.</b>	105081	<b>Ref. No.</b>	290200480 A00004
	burner cap D ø 80mm			

	<b>Part No.</b>	104096	<b>Ref. No.</b>	241202412
	<b>description</b> burner holder with nozzle holder connection M20x1.5			
<b>For models:</b>	64-020T-64-040T, 64-040FCE, 64-040FE, 64-040F-FV, 64-222F, 64-222FCE, 64-222FE, 64-222T, 700-020A-C-T, 700-040A-C-T, 700-040FB, 700-040FEB, 700-138A-C-T, 700-138FBA, 700-138FEBA, 700-162A-C-T, 700-162FBA, 700-162FEBA, 700-162FG, 700-222A-C, 700-222FB, 700-222FEB, 700-222T, 700-224A-C, 700-224FBA, 700-224FEBA, 700-224FG, 700-224T, 900-020A-C-T, 900-040A-C-T, 900-040F, 900-040FE, 900-138A-C-T, 900-138FA, 900-138FEA, 900-162A-C-T, 900-162FA, 900-162FEA, 900-162FG, 900-182F, 900-182FE, 900-302			
<b>accessories for</b>	104096			
	<b>Part No.</b>	101250	<b>Ref. No.</b>	270201680
	union nut thread M20x1.5 for pipe ø 10mm			
	<b>Part No.</b>	101278	<b>Ref. No.</b>	—
	olive for pipe ø 10mm Qty 1 pcs			
	<b>Part No.</b>	104091	<b>Ref. No.</b>	790300799
	burner head D ø 124mm for burner cap ø 80mm suitable for 50, 90, 92, 110 series (old)			
	<b>Part No.</b>	104093	<b>Ref. No.</b>	270200170 770324790
	venturi C/D			
	<b>Part No.</b>	105060	<b>Ref. No.</b>	760305080 764305190
	burner head C for burner cap ø 60mm suitable for 60, 62 series			
	<b>Part No.</b>	105062	<b>Ref. No.</b>	760311640
	venturi C			
	<b>Part No.</b>	105068	<b>Ref. No.</b>	741312350
	air mixing sleeve			
	<b>Part No.</b>	105076	<b>Ref. No.</b>	790300789
	burner head C for burner cap ø 60mm suitable for 70, 90, 92 series (old)			
	<b>Part No.</b>	105079	<b>Ref. No.</b>	770336760
	burner head D ø 100mm			
	<b>Part No.</b>	105091	<b>Ref. No.</b>	770339300
	burner head C for burner cap ø 60mm			
	<b>Part No.</b>	105098	<b>Ref. No.</b>	770336750
	burner head D for burner cap ø 80mm			
	<b>Part No.</b>	105099	<b>Ref. No.</b>	A00419
	burner head A for burner cap ø 110mm			

<b>accessories for</b>	104096			
	<b>Part No.</b>	105100	<b>Ref. No.</b>	A00418
	burner head A for burner cap ø 110mm			
	<b>Part No.</b>	105119	<b>Ref. No.</b>	A00420
	burner head B for burner cap ø 90mm			

	<b>Part No.</b>	105077	<b>Ref. No.</b>	270204230 290200460
	<b>description</b> burner ring C for burner cap ø 60mm			
<b>accessories for</b>	105077			
	<b>Part No.</b>	104093	<b>Ref. No.</b>	270200170 770324790
	venturi C/D			
	<b>Part No.</b>	104096	<b>Ref. No.</b>	241202412
	burner holder with nozzle holder connection M20x1.5			
	<b>Part No.</b>	105068	<b>Ref. No.</b>	741312350
	air mixing sleeve			
	<b>Part No.</b>	105076	<b>Ref. No.</b>	790300789
	burner head C for burner cap ø 60mm suitable for 70, 90, 92 series (old)			
	<b>Part No.</b>	105078	<b>Ref. No.</b>	290200450
	burner cap C ø 60mm			
	<b>Part No.</b>	105091	<b>Ref. No.</b>	770339300
	burner head C for burner cap ø 60mm			

	<b>Part No.</b>	105082	<b>Ref. No.</b>	A00003
	<b>description</b> burner ring C with burner cap ø60mm			
<b>For models:</b>	64-020T-64-040T, 64-040FCE, 64-040FE, 64-040F-FV, 64-222F, 64-222FCE, 64-222FE, 64-222T, 700-020A-C-T, 700-040A-C-T, 700-040FB, 700-040FEB, 700-138A-C-T, 700-138FBA, 700-138FEBA, 700-162A-C-T, 700-162FBA, 700-162FEBA, 700-162FG, 700-222A-C, 700-222FB, 700-222FEB, 700-222T, 700-224A-C, 700-224FBA, 700-224FEBA, 700-224FG, 700-224T, 900-302			







	<b>Part No.</b>	105080	<b>Ref. No.</b>	270204240
	<b>description</b> burner ring D for burner cap ø 80mm			
<b>accessories for</b>	105080			
	<b>Part No.</b>	104091	<b>Ref. No.</b>	790300799
	burner head D ø 124mm for burner cap ø 80mm suitable for 50, 90, 92, 110 series (old)			
	<b>Part No.</b>	104093	<b>Ref. No.</b>	270200170 770324790
	venturi C/D			

Table continues overleaf



accessories for		105080	
	Part No.	104096	Ref. No. 241202412
burner holder with nozzle holder connection M20x1.5			
	Part No.	105068	Ref. No. 741312350
air mixing sleeve			
	Part No.	105081	Ref. No. 290200480 A00004
burner cap D ø 80mm			
	Part No.	105098	Ref. No. 770336750
burner head D for burner cap ø 80mm			

1			
Part No.	105083	Ref. No.	A00004
description burner ring D with burner cap ø85mm			
For models: 900-020A-C-T, 900-040A-C-T, 900-040F, 900-040FE, 900-138A-C-T, 900-138FA, 900-138FEA, 900-162A-C-T, 900-162FA, 900-162FEA, 900-162FG, 900-182F, 900-182FE, 900-302			

1			
Part No.	105062	Ref. No.	760311640
description venturi C			
For models: 64-020T-64-040T, 64-040FCE, 64-040FE, 64-040F-FV, 64-222F, 64-222FCE, 64-222FE, 64-222T			
accessories for		105062	
	Part No.	103060	Ref. No. 770319550
burner cap C ø 70mm			
	Part No.	104096	Ref. No. 241202412
burner holder with nozzle holder connection M20x1.5			
	Part No.	105060	Ref. No. 760305080 764305190
burner head C for burner cap ø 60mm suitable for 60, 62 series			
	Part No.	105068	Ref. No. 741312350
air mixing sleeve			

1			
Part No.	104093	Ref. No.	270200170 770324790
description venturi C/D			
For models: 64-222F, 64-222FCE, 64-222FE, 64-222T, 700-020A-C-T, 700-040A-C-T, 700-040FB, 700-040FEB, 700-138A-C-T, 700-138FBA, 700-138FEBA, 700-162A-C-T, 700-162FBA, 700-162FEBA, 700-162FG, 700-222AC, 700-222FB, 700-222FEB, 700-222T, 700-224A-C, 700-224FBA, 700-224FEBA, 700-224FG, 700-224T, 900-020A-C-T, 900-040A-C-T, 900-040F, 900-040FE, 900-138A-C-T, 900-138FA, 900-138FEA, 900-162A-C-T, 900-162FA, 900-162FEA, 900-162FG, 900-182F, 900-182FE			
accessories for		104093	
	Part No.	104091	Ref. No. 790300799
burner head D ø 124mm for burner cap ø 80mm suitable for 50, 90, 92, 110 series (old)			
	Part No.	104096	Ref. No. 241202412
burner holder with nozzle holder connection M20x1.5			
	Part No.	105068	Ref. No. 741312350
air mixing sleeve			
	Part No.	105076	Ref. No. 790300789
burner head C for burner cap ø 60mm suitable for 70, 90, 92 series (old)			
	Part No.	105079	Ref. No. 770336760
burner head D ø 100mm			
	Part No.	105091	Ref. No. 770339300
burner head C for burner cap ø 60mm			
	Part No.	105098	Ref. No. 770336750
burner head D for burner cap ø 80mm			
	Part No.	105099	Ref. No. A00419
burner head A for burner cap ø 110mm			
	Part No.	105100	Ref. No. A00418
burner head A for burner cap ø 110mm			
	Part No.	105119	Ref. No. A00420
burner head B for burner cap ø 90mm			



## 700/900 (old series)



1

<b>Part No.</b>	105068	<b>Ref. No.</b>	741312350
<b>description</b>	air mixing sleeve		
<b>For models:</b>	64-020T-64-040T, 64-040FCE, 64-040FE, 64-040F-FV, 64-222F, 64-222FCE, 64-222FE, 64-222T, 700-020A-C-T, 700-040A-C-T, 700-040FB, 700-040FEB, 700-138A-C-T, 700-138FBA, 700-138FEBA, 700-162A-C-T, 700-162FBA, 700-162FEBA, 700-162FG, 700-222A-C, 700-222FB, 700-222FEB, 700-222T, 700-224A-C, 700-224FBA, 700-224FEBA, 700-224FG, 700-224T, 900-020A-C-T, 900-040A-C-T, 900-040F, 900-040FE, 900-138A-C-T, 900-138FA, 900-138FEA, 900-162A-C-T, 900-162FA, 900-162FEA, 900-162FG, 900-182F, 900-182FE, 900-302		
<b>accessories for</b>	105068		
	<b>Part No.</b>	104091	<b>Ref. No.</b> 790300799
	burner head D ø 124mm for burner cap ø 80mm suitable for 50, 90, 92, 110 series (old)		
	<b>Part No.</b>	104093	<b>Ref. No.</b> 270200170 770324790
	venturi C/D		
	<b>Part No.</b>	104096	<b>Ref. No.</b> 241202412
	burner holder with nozzle holder connection M20x1.5		
	<b>Part No.</b>	105060	<b>Ref. No.</b> 760305080 764305190
	burner head C for burner cap ø 60mm suitable for 60, 62 series		
	<b>Part No.</b>	105062	<b>Ref. No.</b> 760311640
	venturi C		
	<b>Part No.</b>	105076	<b>Ref. No.</b> 790300789
	burner head C for burner cap ø 60mm suitable for 70, 90, 92 series (old)		
	<b>Part No.</b>	105079	<b>Ref. No.</b> 770336760
	burner head D ø 100mm		
	<b>Part No.</b>	105091	<b>Ref. No.</b> 770339300
	burner head C for burner cap ø 60mm		
	<b>Part No.</b>	105098	<b>Ref. No.</b> 770336750
	burner head D for burner cap ø 80mm		
	<b>Part No.</b>	105099	<b>Ref. No.</b> A00419
	burner head A for burner cap ø 110mm		
	<b>Part No.</b>	105100	<b>Ref. No.</b> A00418
	burner head A for burner cap ø 110mm		
	<b>Part No.</b>	105119	<b>Ref. No.</b> A00420
	burner head B for burner cap ø 90mm		
	<b>Part No.</b>	105707	<b>Ref. No.</b> —
	burner cap ø 95mm		
	<b>Part No.</b>	105708	<b>Ref. No.</b> —
	burner head for burner cap ø 95mm		
	<b>Part No.</b>	105709	<b>Ref. No.</b> —
	venturi		

<b>accessories for</b>	105068		
	<b>Part No.</b>	105710	<b>Ref. No.</b> —
	burner holder with nozzle holder		

	1		
<b>Part No.</b>	103060	<b>Ref. No.</b>	770319550
<b>description</b>	burner cap C ø 70mm		
<b>For models:</b>	64-222F, 64-222FCE, 64-222FE, 64-222T		
<b>accessories for</b>	103060		
	<b>Part No.</b>	104096	<b>Ref. No.</b> 241202412
	burner holder with nozzle holder connection M20x1.5		
	<b>Part No.</b>	105060	<b>Ref. No.</b> 760305080 764305190
	burner head C for burner cap ø 60mm suitable for 60, 62 series		
	<b>Part No.</b>	105062	<b>Ref. No.</b> 760311640
	venturi C		
	<b>Part No.</b>	105068	<b>Ref. No.</b> 741312350
	air mixing sleeve		



	1		
<b>Part No.</b>	103061	<b>Ref. No.</b>	770319560
<b>description</b>	burner cap D ø 100mm		
<b>For models:</b>	700-222A-C, 700-222FB, 700-222FEB, 700-222T, 700-224A-C, 700-224FBA, 700-224FEBA, 700-224FG, 700-224T		
<b>accessories for</b>	103061		
	<b>Part No.</b>	104091	<b>Ref. No.</b> 790300799
	burner head D ø 124mm for burner cap ø 80mm suitable for 50, 90, 92, 110 series (old)		
	<b>Part No.</b>	104093	<b>Ref. No.</b> 270200170 770324790
	venturi C/D		
	<b>Part No.</b>	104096	<b>Ref. No.</b> 241202412
	burner holder with nozzle holder connection M20x1.5		
	<b>Part No.</b>	105068	<b>Ref. No.</b> 741312350
	air mixing sleeve		
	<b>Part No.</b>	105079	<b>Ref. No.</b> 770336760
	burner head D ø 100mm		

	1		
<b>Part No.</b>	103062	<b>Ref. No.</b>	241200430
<b>description</b>	burner cap E ø 135mm		



 <p>1</p>			
<b>Part No.</b>	104091	<b>Ref. No.</b>	790300799
<b>description</b>	burner head D ø 124mm for burner cap ø 80mm suitable for 50, 90, 92, 110 series (old)		
<b>accessories for</b>	104091		
	<b>Part No.</b>	104093	<b>Ref. No.</b> 270200170 770324790
venturi C/D			
	<b>Part No.</b>	105068	<b>Ref. No.</b> 741312350
air mixing sleeve			
	<b>Part No.</b>	105080	<b>Ref. No.</b> 270204240
burner ring D for burner cap ø 80mm			
	<b>Part No.</b>	105081	<b>Ref. No.</b> 290200480 A00004
burner cap D ø 80mm			

 <p>1</p>			
<b>Part No.</b>	104096	<b>Ref. No.</b>	241202412
<b>description</b>	burner holder with nozzle holder connection M20x1.5		
<b>For models:</b>	64-020T-64-040T, 64-040FCE, 64-040FE, 64-040F-FV, 64-222F, 64-222FCE, 64-222FE, 64-222T, 700-020A-C-T, 700-040A-C-T, 700-040FB, 700-040FEB, 700-138A-C-T, 700-138FBA, 700-138FEBA, 700-162A-C-T, 700-162FBA, 700-162FEBA, 700-162FG, 700-222A-C, 700-222FB, 700-222FEB, 700-222T, 700-224A-C, 700-224FBA, 700-224FEBA, 700-224FG, 700-224T, 900-020A-C-T, 900-040A-C-T, 900-040F, 900-040FE, 900-138A-C-T, 900-138FA, 900-138FEA, 900-162A-C-T, 900-162FA, 900-162FEA, 900-162FG, 900-182F, 900-182FE, 900-302		
<b>accessories for</b>	104096		
	<b>Part No.</b>	101250	<b>Ref. No.</b> 270201680
union nut thread M20x1.5 for pipe ø 10mm			
	<b>Part No.</b>	101278	<b>Ref. No.</b> —
olive for pipe ø 10mm Qty 1 pcs			
	<b>Part No.</b>	104091	<b>Ref. No.</b> 790300799
burner head D ø 124mm for burner cap ø 80mm suitable for 50, 90, 92, 110 series (old)			
	<b>Part No.</b>	104093	<b>Ref. No.</b> 270200170 770324790
venturi C/D			
	<b>Part No.</b>	105060	<b>Ref. No.</b> 760305080 764305190
burner head C for burner cap ø 60mm suitable for 60, 62 series			
	<b>Part No.</b>	105062	<b>Ref. No.</b> 760311640
venturi C			
	<b>Part No.</b>	105068	<b>Ref. No.</b> 741312350
air mixing sleeve			
	<b>Part No.</b>	105076	<b>Ref. No.</b> 790300789
burner head C for burner cap ø 60mm suitable for 70, 90, 92 series (old)			

<b>accessories for</b>	104096		
	<b>Part No.</b>	105079	<b>Ref. No.</b> 770336760
burner head D ø 100mm			
	<b>Part No.</b>	105091	<b>Ref. No.</b> 770339300
burner head C for burner cap ø 60mm			
	<b>Part No.</b>	105098	<b>Ref. No.</b> 770336750
burner head D for burner cap ø 80mm			
	<b>Part No.</b>	105099	<b>Ref. No.</b> A00419
burner head A for burner cap ø 110mm			
	<b>Part No.</b>	105100	<b>Ref. No.</b> A00418
burner head A for burner cap ø 110mm			
	<b>Part No.</b>	105119	<b>Ref. No.</b> A00420
burner head B for burner cap ø 90mm			











 <p>1</p>			
<b>Part No.</b>	104093	<b>Ref. No.</b>	270200170 770324790
<b>description</b>	venturi C/D		
<b>For models:</b>	64-222F, 64-222FCE, 64-222FE, 64-222T, 700-020A-C-T, 700-040A-C-T, 700-040FB, 700-040FEB, 700-138A-C-T, 700-138FBA, 700-138FEBA, 700-162A-C-T, 700-162FBA, 700-162FEBA, 700-162FG, 700-222A-C, 700-222FB, 700-222FEB, 700-222T, 700-224A-C, 700-224FBA, 700-224FEBA, 700-224FG, 700-224T, 900-020A-C-T, 900-040A-C-T, 900-040F, 900-040FE, 900-138A-C-T, 900-138FA, 900-138FEA, 900-162A-C-T, 900-162FA, 900-162FEA, 900-162FG, 900-182F, 900-182FE		
<b>accessories for</b>	104093		
	<b>Part No.</b>	104091	<b>Ref. No.</b> 790300799
burner head D ø 124mm for burner cap ø 80mm suitable for 50, 90, 92, 110 series (old)			
	<b>Part No.</b>	104096	<b>Ref. No.</b> 241202412
burner holder with nozzle holder connection M20x1.5			
	<b>Part No.</b>	105068	<b>Ref. No.</b> 741312350
air mixing sleeve			
	<b>Part No.</b>	105076	<b>Ref. No.</b> 790300789
burner head C for burner cap ø 60mm suitable for 70, 90, 92 series (old)			
	<b>Part No.</b>	105079	<b>Ref. No.</b> 770336760
burner head D ø 100mm			
	<b>Part No.</b>	105091	<b>Ref. No.</b> 770339300
burner head C for burner cap ø 60mm			
	<b>Part No.</b>	105098	<b>Ref. No.</b> 770336750
burner head D for burner cap ø 80mm			
	<b>Part No.</b>	105099	<b>Ref. No.</b> A00419
burner head A for burner cap ø 110mm			

Table continues overleaf



















accessories for		104093		
	Part No.	105100	Ref. No.	A00418
	burner head A for burner cap ø 110mm			
	Part No.	105119	Ref. No.	A00420
	burner head B for burner cap ø 90mm			

## 500, 700new, 900, 920, 110 (new series)



1

Part No.	105068	Ref. No.	741312350
description	air mixing sleeve		
For models:	64-020T-64-040T, 64-040FCE, 64-040FE, 64-040F-FV, 64-222F, 64-222FCE, 64-222FE, 64-222T, 700-020A-C-T, 700-040A-C-T, 700-040FB, 700-040FEB, 700-138A-C-T, 700-138FBA, 700-138FEBA, 700-162A-C-T, 700-162FBA, 700-162FEBA, 700-162FG, 700-222A-C, 700-222FB, 700-222FEB, 700-222T, 700-224A-C, 700-224FBA, 700-224FEBA, 700-224FG, 700-224T, 900-020A-C-T, 900-040A-C-T, 900-040F, 900-040FE, 900-138A-C-T, 900-138FA, 900-138FEA, 900-162A-C-T, 900-162FA, 900-162FEA, 900-162FG, 900-182F, 900-182FE, 900-302		
accessories for		105068	
	Part No.	104091	Ref. No. 790300799
	burner head D ø 124mm for burner cap ø 80mm suitable for 50, 90, 92, 110 series (old)		
	Part No.	104093	Ref. No. 270200170 770324790
	venturi C/D		
	Part No.	104096	Ref. No. 241202412
	burner holder with nozzle holder connection M20x1.5		
	Part No.	105060	Ref. No. 760305080 764305190
	burner head C for burner cap ø 60mm suitable for 60, 62 series		
	Part No.	105062	Ref. No. 760311640
	venturi C		
	Part No.	105076	Ref. No. 790300789
	burner head C for burner cap ø 60mm suitable for 70, 90, 92 series (old)		
	Part No.	105079	Ref. No. 770336760
	burner head D ø 100mm		
	Part No.	105091	Ref. No. 770339300
	burner head C for burner cap ø 60mm		
	Part No.	105098	Ref. No. 770336750
	burner head D for burner cap ø 80mm		
	Part No.	105099	Ref. No. A00419
	burner head A for burner cap ø 110mm		
	Part No.	105100	Ref. No. A00418
	burner head A for burner cap ø 110mm		
	Part No.	105119	Ref. No. A00420
	burner head B for burner cap ø 90mm		
	Part No.	105707	Ref. No. —
	burner cap ø 95mm		

accessories for		105068		
	Part No.	105708	Ref. No.	—
	burner head for burner cap ø 95mm			
	Part No.	105709	Ref. No.	—
	venturi			
	Part No.	105710	Ref. No.	—
	burner holder with nozzle holder			







1

Part No.	105088	Ref. No.	270203540
description	burner cap A ø 110mm with central hole		
For models:	900-020A-C-T, 900-040A-C-T, 900-040F, 900-040FE, 900-138A-C-T, 900-138FA, 900-138FEA, 900-162A-C-T, 900-162FA, 900-162FEA, 900-162FG, 900-182F, 900-182FE		
accessories for		105088	
	Part No.	104093	Ref. No. 270200170 770324790
	venturi C/D		
	Part No.	104096	Ref. No. 241202412
	burner holder with nozzle holder connection M20x1.5		
	Part No.	105068	Ref. No. 741312350
	air mixing sleeve		
	Part No.	105099	Ref. No. A00419
	burner head A for burner cap ø 110mm		
	Part No.	105100	Ref. No. A00418
	burner head A for burner cap ø 110mm		



1

Part No.	105084	Ref. No.	270203550
description	burner cap B ø 90mm with central hole		
For models:	700-020A-C-T, 700-040A-C-T, 700-040FB, 700-040FEB, 700-138A-C-T, 700-138FBA, 700-138FEBA, 700-162A-C-T, 700-162FBA, 700-162FEBA, 700-162FG, 700-222A-C, 700-222FB, 700-222FEB, 700-222T, 700-224A-C, 700-224FBA, 700-224FEBA, 700-224FG, 700-224T		
accessories for		105084	
	Part No.	104093	Ref. No. 270200170 770324790
	venturi C/D		
	Part No.	104096	Ref. No. 241202412
	burner holder with nozzle holder connection M20x1.5		
	Part No.	105068	Ref. No. 741312350
	air mixing sleeve		
	Part No.	105119	Ref. No. A00420
	burner head B for burner cap ø 90mm		





 <p>1</p>			
<b>Part No.</b>	105078	<b>Ref. No.</b>	290200450
<b>description</b>	burner cap C ø 60mm		
<b>accessories for</b>	105078		
	<b>Part No.</b>	104093	<b>Ref. No.</b> 270200170 770324790
	venturi C/D		
	<b>Part No.</b>	104096	<b>Ref. No.</b> 241202412
	burner holder with nozzle holder connection M20x1.5		
	<b>Part No.</b>	105068	<b>Ref. No.</b> 741312350
	air mixing sleeve		
	<b>Part No.</b>	105076	<b>Ref. No.</b> 790300789
	burner head C for burner cap ø 60mm suitable for 70, 90, 92 series (old)		
	<b>Part No.</b>	105077	<b>Ref. No.</b> 270204230 290200460
	burner ring C for burner cap ø 60mm		
	<b>Part No.</b>	105091	<b>Ref. No.</b> 770339300
	burner head C for burner cap ø 60mm		

 <p>1</p>			
<b>Part No.</b>	105081	<b>Ref. No.</b>	290200480 A00004
<b>description</b>	burner cap D ø 80mm		
<b>accessories for</b>	105081		
	<b>Part No.</b>	104091	<b>Ref. No.</b> 790300799
	burner head D ø 124mm for burner cap ø 80mm suitable for 50, 90, 92, 110 series (old)		
	<b>Part No.</b>	104093	<b>Ref. No.</b> 270200170 770324790
	venturi C/D		
	<b>Part No.</b>	104096	<b>Ref. No.</b> 241202412
	burner holder with nozzle holder connection M20x1.5		
	<b>Part No.</b>	105068	<b>Ref. No.</b> 741312350
	air mixing sleeve		
	<b>Part No.</b>	105080	<b>Ref. No.</b> 270204240
	burner ring D for burner cap ø 80mm		
	<b>Part No.</b>	105098	<b>Ref. No.</b> 770336750
	burner head D for burner cap ø 80mm		

 <p>1</p>			
<b>Part No.</b>	107018	<b>Ref. No.</b>	A00471
<b>description</b>	burner cap ø 175mm		

 <p>1</p>			
<b>Part No.</b>	105099	<b>Ref. No.</b>	A00419
<b>description</b>	burner head A for burner cap ø 110mm		
<b>accessories for</b>	105099		
	<b>Part No.</b>	104093	<b>Ref. No.</b> 270200170 770324790
	venturi C/D		
	<b>Part No.</b>	104096	<b>Ref. No.</b> 241202412
	burner holder with nozzle holder connection M20x1.5		
	<b>Part No.</b>	105068	<b>Ref. No.</b> 741312350
	air mixing sleeve		
	<b>Part No.</b>	105088	<b>Ref. No.</b> 270203540
	burner cap A ø 110mm with central hole		

 <p>1</p>			
<b>Part No.</b>	105100	<b>Ref. No.</b>	A00418
<b>description</b>	burner head A for burner cap ø 110mm		
<b>For models:</b>	900-020A-C-T, 900-040A-C-T, 900-040F, 900-040FE, 900-138A-C-T, 900-138FA, 900-138FEA, 900-162A-C-T, 900-162FA, 900-162FEA, 900-162FG, 900-182F, 900-182FE		
<b>accessories for</b>	105100		
	<b>Part No.</b>	104093	<b>Ref. No.</b> 270200170 770324790
	venturi C/D		
	<b>Part No.</b>	104096	<b>Ref. No.</b> 241202412
	burner holder with nozzle holder connection M20x1.5		
	<b>Part No.</b>	105068	<b>Ref. No.</b> 741312350
	air mixing sleeve		
	<b>Part No.</b>	105088	<b>Ref. No.</b> 270203540
	burner cap A ø 110mm with central hole		



			
1			
<b>Part No.</b>	105119	<b>Ref. No.</b>	A00420
<b>description</b>	burner head B for burner cap ø 90mm		
<b>For models:</b>	700-020A-C-T, 700-040A-C-T, 700-040FB, 700-040FEB, 700-138A-C-T, 700-138FBA, 700-138FEBA, 700-162A-C-T, 700-162FBA, 700-162FEBA, 700-162FG, 700-222A-C, 700-222FB, 700-222FEB, 700-222T, 700-224A-C, 700-224FBA, 700-224FEBA, 700-224FG, 700-224T		
<b>accessories for</b>	105119		
	<b>Part No.</b>	104093	<b>Ref. No.</b> 270200170 770324790
	venturi C/D		
	<b>Part No.</b>	104096	<b>Ref. No.</b> 241202412
	burner holder with nozzle holder connection M20x1.5		
	<b>Part No.</b>	105068	<b>Ref. No.</b> 741312350
	air mixing sleeve		
	<b>Part No.</b>	105084	<b>Ref. No.</b> 270203550
	burner cap B ø 90mm with central hole		

			
1			
<b>Part No.</b>	105091	<b>Ref. No.</b>	770339300
<b>description</b>	burner head C for burner cap ø 60mm		
<b>For models:</b>	700-020A-C-T, 700-040A-C-T, 700-040FB, 700-040FEB, 700-138A-C-T, 700-138FBA, 700-138FEBA, 700-162A-C-T, 700-162FBA, 700-162FEBA, 700-162FG, 700-222A-C, 700-222FB, 700-222FEB, 700-222T, 700-224A-C, 700-224FBA, 700-224FEBA, 700-224FG, 700-224T, 900-302		
<b>accessories for</b>	105091		
	<b>Part No.</b>	104093	<b>Ref. No.</b> 270200170 770324790
	venturi C/D		
	<b>Part No.</b>	104096	<b>Ref. No.</b> 241202412
	burner holder with nozzle holder connection M20x1.5		
	<b>Part No.</b>	105068	<b>Ref. No.</b> 741312350
	air mixing sleeve		
	<b>Part No.</b>	105077	<b>Ref. No.</b> 270204230 290200460
	burner ring C for burner cap ø 60mm		
	<b>Part No.</b>	105078	<b>Ref. No.</b> 290200450
	burner cap C ø 60mm		

			
1			
<b>Part No.</b>	105098	<b>Ref. No.</b>	770336750
<b>description</b>	burner head D for burner cap ø 80mm		
<b>For models:</b>	900-020A-C-T, 900-040A-C-T, 900-040F, 900-040FE, 900-138A-C-T, 900-138FA, 900-138FEA, 900-162A-C-T, 900-162FA, 900-162FEA, 900-162FG, 900-182F, 900-182FE, 900-302		
<b>accessories for</b>	105098		
	<b>Part No.</b>	104093	<b>Ref. No.</b> 270200170 770324790
	venturi C/D		
	<b>Part No.</b>	104096	<b>Ref. No.</b> 241202412
	burner holder with nozzle holder connection M20x1.5		
	<b>Part No.</b>	105068	<b>Ref. No.</b> 741312350
	air mixing sleeve		
	<b>Part No.</b>	105080	<b>Ref. No.</b> 270204240
	burner ring D for burner cap ø 80mm		
	<b>Part No.</b>	105081	<b>Ref. No.</b> 290200480 A00004
	burner cap D ø 80mm		

			
1			
<b>Part No.</b>	107025	<b>Ref. No.</b>	A00472
<b>description</b>	burner head ø 185mm for burner cap ø 185mm		









			
1			
<b>Part No.</b>	104096	<b>Ref. No.</b>	241202412
<b>description</b>	burner holder with nozzle holder connection M20x1.5		
<b>For models:</b>	64-020T-64-040T, 64-040FCE, 64-040FE, 64-040FV, 64-222F, 64-222FCE, 64-222FE, 64-222T, 700-020A-C-T, 700-040A-C-T, 700-040FB, 700-040FEB, 700-138A-C-T, 700-138FBA, 700-138FEBA, 700-162A-C-T, 700-162FBA, 700-162FEBA, 700-162FG, 700-222A-C, 700-222FB, 700-222FEB, 700-222T, 700-224A-C, 700-224FBA, 700-224FEBA, 700-224FG, 700-224T, 900-020A-C-T, 900-040A-C-T, 900-040F, 900-040FE, 900-138A-C-T, 900-138FA, 900-138FEA, 900-162A-C-T, 900-162FA, 900-162FEA, 900-162FG, 900-182F, 900-182FE, 900-302		
<b>accessories for</b>	104096		
	<b>Part No.</b>	101250	<b>Ref. No.</b> 270201680
	union nut thread M20x1.5 for pipe ø 10mm		
	<b>Part No.</b>	101278	<b>Ref. No.</b> —
	olive for pipe ø 10mm Qty 1 pcs		
	<b>Part No.</b>	104091	<b>Ref. No.</b> 790300799
	burner head D ø 124mm for burner cap ø 80mm suitable for 50, 90, 92, 110 series (old)		



Table continues overleaf



accessories for		104096	
	Part No.	104093	Ref. No. 270200170 770324790
venturi C/D			
	Part No.	105060	Ref. No. 760305080 764305190
burner head C for burner cap ø 60mm suitable for 60, 62 series			
	Part No.	105062	Ref. No. 760311640
venturi C			
	Part No.	105068	Ref. No. 741312350
air mixing sleeve			
	Part No.	105076	Ref. No. 790300789
burner head C for burner cap ø 60mm suitable for 70, 90, 92 series (old)			
	Part No.	105079	Ref. No. 770336760
burner head D ø 100mm			
	Part No.	105091	Ref. No. 770339300
burner head C for burner cap ø 60mm			
	Part No.	105098	Ref. No. 770336750
burner head D for burner cap ø 80mm			
	Part No.	105099	Ref. No. A00419
burner head A for burner cap ø 110mm			
	Part No.	105100	Ref. No. A00418
burner head A for burner cap ø 110mm			
	Part No.	105119	Ref. No. A00420
burner head B for burner cap ø 90mm			

	1		
Part No.	107017	Ref. No.	292305990
description	burner pipe ø 28mm L 110mm		
For models:	90-301		

	1		
Part No.	105077	Ref. No.	270204230 290200460
description	burner ring C for burner cap ø 60mm		
accessories for	105077		
	Part No.	104093	Ref. No. 270200170 770324790
venturi C/D			
	Part No.	104096	Ref. No. 241202412
burner holder with nozzle holder connection M20x1.5			
	Part No.	105068	Ref. No. 741312350
air mixing sleeve			

accessories for		105077	
	Part No.	105076	Ref. No. 790300789
burner head C for burner cap ø 60mm suitable for 70, 90, 92 series (old)			
	Part No.	105078	Ref. No. 290200450
burner cap C ø 60mm			
	Part No.	105091	Ref. No. 770339300
burner head C for burner cap ø 60mm			

1			
Part No.	105082	Ref. No.	A00003
description	burner ring C with burner cap ø60mm		
For models:	64-020T-64-040T, 64-040FCE, 64-040FE, 64-040F-FV, 64-222F, 64-222FCE, 64-222FE, 64-222T, 700-020A-C-T, 700-040A-C-T, 700-040FB, 700-040FEB, 700-138A-C-T, 700-138FBA, 700-138FEBA, 700-162A-C-T, 700-162FBA, 700-162FEBA, 700-162FG, 700-222A-C, 700-222FB, 700-222FEB, 700-222T, 700-224A-C, 700-224FBA, 700-224FEBA, 700-224FG, 700-224T, 900-302		

	1		
Part No.	105080	Ref. No.	270204240
description	burner ring D for burner cap ø 80mm		
accessories for	105080		
	Part No.	104091	Ref. No. 790300799
burner head D ø 124mm for burner cap ø 80mm suitable for 50, 90, 92, 110 series (old)			
	Part No.	104093	Ref. No. 270200170 770324790
venturi C/D			
	Part No.	104096	Ref. No. 241202412
burner holder with nozzle holder connection M20x1.5			
	Part No.	105068	Ref. No. 741312350
air mixing sleeve			
	Part No.	105081	Ref. No. 290200480 A00004
burner cap D ø 80mm			
	Part No.	105098	Ref. No. 770336750
burner head D for burner cap ø 80mm			



			
1			
<b>Part No.</b>	107012	<b>Ref. No.</b>	711107640
<b>description</b>	cover plate ø 83mm		

			
1			
<b>Part No.</b>	104093	<b>Ref. No.</b>	270200170 770324790
<b>description</b>	venturi C/D		
<b>For models:</b>	64-222F, 64-222FCE, 64-222FE, 64-222T, 700-020A-C-T, 700-040A-C-T, 700-040FB, 700-040FEB, 700-138A-C-T, 700-138FBA, 700-138FEBA, 700-162A-C-T, 700-162FBA, 700-162FEBA, 700-162FG, 700-222AC, 700-222FB, 700-222FEB, 700-222T, 700-224A-C, 700-224FBA, 700-224FEBA, 700-224FG, 700-224T, 900-020A-C-T, 900-040A-C-T, 900-040F, 900-040FE, 900-138A-C-T, 900-138FA, 900-138FEA, 900-162A-C-T, 900-162FA, 900-162FEA, 900-162FG, 900-182F, 900-182FE		
<b>accessories for</b>	104093		
	<b>Part No.</b>	104091	<b>Ref. No.</b> 790300799
	burner head D ø 124mm for burner cap ø 80mm suitable for 50, 90, 92, 110 series (old)		
	<b>Part No.</b>	104096	<b>Ref. No.</b> 241202412
	burner holder with nozzle holder connection M20x1.5		
	<b>Part No.</b>	105068	<b>Ref. No.</b> 741312350
	air mixing sleeve		
	<b>Part No.</b>	105076	<b>Ref. No.</b> 790300789
	burner head C for burner cap ø 60mm suitable for 70, 90, 92 series (old)		
	<b>Part No.</b>	105079	<b>Ref. No.</b> 770336760
	burner head D ø 100mm		
	<b>Part No.</b>	105091	<b>Ref. No.</b> 770339300
	burner head C for burner cap ø 60mm		
	<b>Part No.</b>	105098	<b>Ref. No.</b> 770336750
	burner head D for burner cap ø 80mm		
	<b>Part No.</b>	105099	<b>Ref. No.</b> A00419
	burner head A for burner cap ø 110mm		
	<b>Part No.</b>	105100	<b>Ref. No.</b> A00418
	burner head A for burner cap ø 110mm		
	<b>Part No.</b>	105119	<b>Ref. No.</b> A00420
	burner head B for burner cap ø 90mm		

## solid tops series 60, 62



			
1			
<b>Part No.</b>	105068	<b>Ref. No.</b>	741312350
<b>description</b>	air mixing sleeve		
<b>For models:</b>	64-020T-64-040T, 64-040FCE, 64-040FE, 64-040F-FV, 64-222F, 64-222FCE, 64-222FE, 64-222T, 700-020A-C-T, 700-040A-C-T, 700-040FB, 700-040FEB, 700-138A-C-T, 700-138FBA, 700-138FEBA, 700-162A-C-T, 700-162FBA, 700-162FEBA, 700-162FG, 700-222A-C, 700-222FB, 700-222FEB, 700-222T, 700-224A-C, 700-224FBA, 700-224FEBA, 700-224FG, 700-224T, 900-020A-C-T, 900-040A-C-T, 900-040F, 900-040FE, 900-138A-C-T, 900-138FA, 900-138FEA, 900-162A-C-T, 900-162FA, 900-162FEA, 900-162FG, 900-182F, 900-182FE, 900-302		
<b>accessories for</b>	105068		
	<b>Part No.</b>	104091	<b>Ref. No.</b> 790300799
	burner head D ø 124mm for burner cap ø 80mm suitable for 50, 90, 92, 110 series (old)		
	<b>Part No.</b>	104093	<b>Ref. No.</b> 270200170 770324790
	venturi C/D		
	<b>Part No.</b>	104096	<b>Ref. No.</b> 241202412
	burner holder with nozzle holder connection M20x1.5		
	<b>Part No.</b>	105060	<b>Ref. No.</b> 760305080 764305190
	burner head C for burner cap ø 60mm suitable for 60, 62 series		
	<b>Part No.</b>	105062	<b>Ref. No.</b> 760311640
	venturi C		
	<b>Part No.</b>	105076	<b>Ref. No.</b> 790300789
	burner head C for burner cap ø 60mm suitable for 70, 90, 92 series (old)		
	<b>Part No.</b>	105079	<b>Ref. No.</b> 770336760
	burner head D ø 100mm		
	<b>Part No.</b>	105091	<b>Ref. No.</b> 770339300
	burner head C for burner cap ø 60mm		
	<b>Part No.</b>	105098	<b>Ref. No.</b> 770336750
	burner head D for burner cap ø 80mm		
	<b>Part No.</b>	105099	<b>Ref. No.</b> A00419
	burner head A for burner cap ø 110mm		
	<b>Part No.</b>	105100	<b>Ref. No.</b> A00418
	burner head A for burner cap ø 110mm		
	<b>Part No.</b>	105119	<b>Ref. No.</b> A00420
	burner head B for burner cap ø 90mm		
	<b>Part No.</b>	105707	<b>Ref. No.</b> —
	burner cap ø 95mm		
	<b>Part No.</b>	105708	<b>Ref. No.</b> —
	burner head for burner cap ø 95mm		
	<b>Part No.</b>	105709	<b>Ref. No.</b> —
	venturi		



Table continues overleaf







<b>accessories for</b>	105068		
	<b>Part No.</b>	105710	<b>Ref. No.</b> —
	burner holder with nozzle holder		

1 			
<b>Part No.</b>	105078	<b>Ref. No.</b>	290200450
<b>description</b>	burner cap C ø 60mm		
<b>accessories for</b>	105078		
	<b>Part No.</b>	104093	<b>Ref. No.</b> 270200170 770324790
	venturi C/D		
	<b>Part No.</b>	104096	<b>Ref. No.</b> 241202412
	burner holder with nozzle holder connection M20x1.5		
	<b>Part No.</b>	105068	<b>Ref. No.</b> 741312350
	air mixing sleeve		
	<b>Part No.</b>	105076	<b>Ref. No.</b> 790300789
	burner head C for burner cap ø 60mm suitable for 70, 90, 92 series (old)		
	<b>Part No.</b>	105077	<b>Ref. No.</b> 270204230 290200460
	burner ring C for burner cap ø 60mm		
	<b>Part No.</b>	105091	<b>Ref. No.</b> 770339300
	burner head C for burner cap ø 60mm		

1 			
<b>Part No.</b>	103060	<b>Ref. No.</b>	770319550
<b>description</b>	burner cap C ø 70mm		
<b>For models:</b>	64-222F, 64-222FCE, 64-222FE, 64-222T		
<b>accessories for</b>	103060		
	<b>Part No.</b>	104096	<b>Ref. No.</b> 241202412
	burner holder with nozzle holder connection M20x1.5		
	<b>Part No.</b>	105060	<b>Ref. No.</b> 760305080 764305190
	burner head C for burner cap ø 60mm suitable for 60, 62 series		
	<b>Part No.</b>	105062	<b>Ref. No.</b> 760311640
	venturi C		
	<b>Part No.</b>	105068	<b>Ref. No.</b> 741312350
	air mixing sleeve		

1 			
<b>Part No.</b>	103061	<b>Ref. No.</b>	770319560
<b>description</b>	burner cap D ø 100mm		
<b>For models:</b>	700-222A-C, 700-222FB, 700-222FEB, 700-222T, 700-224A-C, 700-224FBA, 700-224FEBA, 700-224FG, 700-224T		
<b>accessories for</b>	103061		
	<b>Part No.</b>	104091	<b>Ref. No.</b> 790300799
	burner head D ø 124mm for burner cap ø 80mm suitable for 50, 90, 92, 110 series (old)		

<b>accessories for</b>	103061		
	<b>Part No.</b>	104093	<b>Ref. No.</b> 270200170 770324790
	venturi C/D		
	<b>Part No.</b>	104096	<b>Ref. No.</b> 241202412
	burner holder with nozzle holder connection M20x1.5		
	<b>Part No.</b>	105068	<b>Ref. No.</b> 741312350
	air mixing sleeve		
	<b>Part No.</b>	105079	<b>Ref. No.</b> 770336760
	burner head D ø 100mm		

1 			
<b>Part No.</b>	105060	<b>Ref. No.</b>	760305080 764305190
<b>description</b>	burner head C for burner cap ø 60mm suitable for 60, 62 series		
<b>For models:</b>	64-020T-64-040T, 64-040FCE, 64-040FE, 64-040F-FV, 64-222F, 64-222FCE, 64-222FE, 64-222T		
<b>accessories for</b>	105060		
	<b>Part No.</b>	103060	<b>Ref. No.</b> 770319550
	burner cap C ø 70mm		
	<b>Part No.</b>	104096	<b>Ref. No.</b> 241202412
	burner holder with nozzle holder connection M20x1.5		
	<b>Part No.</b>	105062	<b>Ref. No.</b> 760311640
	venturi C		
	<b>Part No.</b>	105068	<b>Ref. No.</b> 741312350
	air mixing sleeve		

1 			
<b>Part No.</b>	105143	<b>Ref. No.</b>	760305630
<b>description</b>	burner head C for burner cap ø 70mm		









1 			
<b>Part No.</b>	105146	<b>Ref. No.</b>	760302390
<b>description</b>	burner head D for burner cap ø 100mm		
<b>accessories for</b>	105146		
	<b>Part No.</b>	103061	<b>Ref. No.</b> 770319560
	burner cap D ø 100mm		
	<b>Part No.</b>	104093	<b>Ref. No.</b> 270200170 770324790
	venturi C/D		

Table continues overleaf





<b>accessories for</b>	105146		
	Part No.	104096	Ref. No. 241202412
	burner holder with nozzle holder connection M20x1.5		
	Part No.	105068	Ref. No. 741312350
	air mixing sleeve		

	1		
<b>Part No.</b>	104096	<b>Ref. No.</b>	241202412
<b>description</b>	burner holder with nozzle holder connection M20x1.5		
<b>For models:</b>	64-020T-64-040T, 64-040FCE, 64-040FE, 64-040F-FV, 64-222F, 64-222FCE, 64-222FE, 64-222T, 700-020A-C-T, 700-040A-C-T, 700-040FB, 700-040FEB, 700-138A-C-T, 700-138FBA, 700-138FEBA, 700-162A-C-T, 700-162FBA, 700-162FEBA, 700-162FG, 700-222A-C, 700-222FB, 700-222FEB, 700-222T, 700-224A-C, 700-224FBA, 700-224FEBA, 700-224FG, 700-224T, 900-020A-C-T, 900-040A-C-T, 900-040F, 900-040FE, 900-138A-C-T, 900-138FA, 900-138FEA, 900-162A-C-T, 900-162FA, 900-162FEA, 900-162FG, 900-182F, 900-182FE, 900-302		
<b>accessories for</b>	104096		
	Part No.	101250	Ref. No. 270201680
	union nut thread M20x1.5 for pipe ø 10mm		
	Part No.	101278	Ref. No. —
	olive for pipe ø 10mm Qty 1 pcs		
	Part No.	104091	Ref. No. 790300799
	burner head D ø 124mm for burner cap ø 80mm suitable for 50, 90, 92, 110 series (old)		
	Part No.	104093	Ref. No. 270200170 770324790
	venturi C/D		
	Part No.	105060	Ref. No. 760305080 764305190
	burner head C for burner cap ø 60mm suitable for 60, 62 series		
	Part No.	105062	Ref. No. 760311640
	venturi C		
	Part No.	105068	Ref. No. 741312350
	air mixing sleeve		
	Part No.	105076	Ref. No. 790300789
	burner head C for burner cap ø 60mm suitable for 70, 90, 92 series (old)		
	Part No.	105079	Ref. No. 770336760
	burner head D ø 100mm		
	Part No.	105091	Ref. No. 770339300
	burner head C for burner cap ø 60mm		
	Part No.	105098	Ref. No. 770336750
	burner head D for burner cap ø 80mm		
	Part No.	105099	Ref. No. A00419
	burner head A for burner cap ø 110mm		
	Part No.	105100	Ref. No. A00418
	burner head A for burner cap ø 110mm		

<b>accessories for</b>	104096		
	Part No.	105119	Ref. No. A00420
	burner head B for burner cap ø 90mm		

	1		
<b>Part No.</b>	105077	<b>Ref. No.</b>	270204230 290200460
<b>description</b>	burner ring C for burner cap ø 60mm		
<b>accessories for</b>	105077		
	Part No.	104093	Ref. No. 270200170 770324790
	venturi C/D		
	Part No.	104096	Ref. No. 241202412
	burner holder with nozzle holder connection M20x1.5		
	Part No.	105068	Ref. No. 741312350
	air mixing sleeve		
	Part No.	105076	Ref. No. 790300789
	burner head C for burner cap ø 60mm suitable for 70, 90, 92 series (old)		
	Part No.	105078	Ref. No. 290200450
	burner cap C ø 60mm		
	Part No.	105091	Ref. No. 770339300
	burner head C for burner cap ø 60mm		

	1		
<b>Part No.</b>	105082	<b>Ref. No.</b>	A00003
<b>description</b>	burner ring C with burner cap ø60mm		
<b>For models:</b>	64-020T-64-040T, 64-040FCE, 64-040FE, 64-040F-FV, 64-222F, 64-222FCE, 64-222FE, 64-222T, 700-020A-C-T, 700-040A-C-T, 700-040FB, 700-040FEB, 700-138A-C-T, 700-138FBA, 700-138FEBA, 700-162A-C-T, 700-162FBA, 700-162FEBA, 700-162FG, 700-222A-C, 700-222FB, 700-222FEB, 700-222T, 700-224A-C, 700-224FBA, 700-224FEBA, 700-224FG, 700-224T, 900-302		





	1		
<b>Part No.</b>	105062	<b>Ref. No.</b>	760311640
<b>description</b>	venturi C		
<b>For models:</b>	64-020T-64-040T, 64-040FCE, 64-040FE, 64-040F-FV, 64-222F, 64-222FCE, 64-222FE, 64-222T		
<b>accessories for</b>	105062		
	Part No.	103060	Ref. No. 770319550
	burner cap C ø 70mm		





Table continues overleaf







<b>accessories for</b> 105062				
	Part No.	104096	Ref. No.	241202412
burner holder with nozzle holder connection M20x1.5				
	Part No.	105060	Ref. No.	760305080 764305190
burner head C for burner cap ø 60mm suitable for 60, 62 series				
	Part No.	105068	Ref. No.	741312350
air mixing sleeve				

solid tops series 70, 90, 92, 110 (old), 700, 900, 920, 110 (new)

 <p>1</p>				
<b>Part No.</b>	105068	<b>Ref. No.</b>	741312350	
<b>description</b>	air mixing sleeve			
<b>For models:</b>	64-020T-64-040T, 64-040FCE, 64-040FE, 64-040F-FV, 64-222F, 64-222FCE, 64-222FE, 64-222T, 700-020A-C-T, 700-040A-C-T, 700-040FB, 700-040FEB, 700-138A-C-T, 700-138FBA, 700-138FEBA, 700-162A-C-T, 700-162FBA, 700-162FEBA, 700-162FG, 700-222A-C, 700-222FB, 700-222FEB, 700-222T, 700-224A-C, 700-224FBA, 700-224FEBA, 700-224FG, 700-224T, 900-020A-C-T, 900-040A-C-T, 900-040F, 900-040FE, 900-138A-C-T, 900-138FA, 900-138FEA, 900-162A-C-T, 900-162FA, 900-162FEA, 900-162FG, 900-182F, 900-182FE, 900-302			
<b>accessories for</b> 105068				
	Part No.	104091	Ref. No.	790300799
burner head D ø 124mm for burner cap ø 80mm suitable for 50, 90, 92, 110 series (old)				
	Part No.	104093	Ref. No.	270200170 770324790
venturi C/D				
	Part No.	104096	Ref. No.	241202412
burner holder with nozzle holder connection M20x1.5				
	Part No.	105060	Ref. No.	760305080 764305190
burner head C for burner cap ø 60mm suitable for 60, 62 series				
	Part No.	105062	Ref. No.	760311640
venturi C				
	Part No.	105076	Ref. No.	790300789
burner head C for burner cap ø 60mm suitable for 70, 90, 92 series (old)				
	Part No.	105079	Ref. No.	770336760
burner head D ø 100mm				
	Part No.	105091	Ref. No.	770339300
burner head C for burner cap ø 60mm				
	Part No.	105098	Ref. No.	770336750
burner head D for burner cap ø 80mm				
	Part No.	105099	Ref. No.	A00419
burner head A for burner cap ø 110mm				
	Part No.	105100	Ref. No.	A00418
burner head A for burner cap ø 110mm				
	Part No.	105119	Ref. No.	A00420
burner head B for burner cap ø 90mm				

<b>accessories for</b> 105068				
	Part No.	105707	Ref. No.	—
burner cap ø 95mm				
	Part No.	105708	Ref. No.	—
burner head for burner cap ø 95mm				
	Part No.	105709	Ref. No.	—
venturi				
	Part No.	105710	Ref. No.	—
burner holder with nozzle holder				

 <p>1</p>				
<b>Part No.</b>	105078	<b>Ref. No.</b>	290200450	
<b>description</b>	burner cap C ø 60mm			
<b>accessories for</b> 105078				
	Part No.	104093	Ref. No.	270200170 770324790
venturi C/D				
	Part No.	104096	Ref. No.	241202412
burner holder with nozzle holder connection M20x1.5				
	Part No.	105068	Ref. No.	741312350
air mixing sleeve				
	Part No.	105076	Ref. No.	790300789
burner head C for burner cap ø 60mm suitable for 70, 90, 92 series (old)				
	Part No.	105077	Ref. No.	270204230 290200460
burner ring C for burner cap ø 60mm				
	Part No.	105091	Ref. No.	770339300
burner head C for burner cap ø 60mm				

 <p>1</p>				
<b>Part No.</b>	103061	<b>Ref. No.</b>	770319560	
<b>description</b>	burner cap D ø 100mm			
<b>For models:</b>	700-222A-C, 700-222FB, 700-222FEB, 700-222T, 700-224A-C, 700-224FBA, 700-224FEBA, 700-224FG, 700-224T			
<b>accessories for</b> 103061				
	Part No.	104091	Ref. No.	790300799
burner head D ø 124mm for burner cap ø 80mm suitable for 50, 90, 92, 110 series (old)				
	Part No.	104093	Ref. No.	270200170 770324790
venturi C/D				
	Part No.	104096	Ref. No.	241202412
burner holder with nozzle holder connection M20x1.5				
	Part No.	105068	Ref. No.	741312350
air mixing sleeve				

Table continues overleaf



<b>accessories for</b>	103061		
	<b>Part No.</b>	105079	<b>Ref. No.</b> 770336760
	burner head D ø 100mm		

	1		
<b>Part No.</b>	105076	<b>Ref. No.</b>	790300789
<b>description</b>	burner head C for burner cap ø 60mm suitable for 70, 90, 92 series (old)		
<b>accessories for</b>	105076		
	<b>Part No.</b>	104093	<b>Ref. No.</b> 270200170 770324790
	venturi C/D		
	<b>Part No.</b>	104096	<b>Ref. No.</b> 241202412
	burner holder with nozzle holder connection M20x1.5		
	<b>Part No.</b>	105068	<b>Ref. No.</b> 741312350
	air mixing sleeve		
	<b>Part No.</b>	105077	<b>Ref. No.</b> 270204230 290200460
	burner ring C for burner cap ø 60mm		
	<b>Part No.</b>	105078	<b>Ref. No.</b> 290200450
	burner cap C ø 60mm		



	1		
<b>Part No.</b>	105079	<b>Ref. No.</b>	770336760
<b>description</b>	burner head D ø 100mm		
<b>For models:</b>	700-222A-C, 700-222FB, 700-222FEB, 700-222T, 700-224A-C, 700-224FBA, 700-224FEBA, 700-224FG, 700-224T		
<b>accessories for</b>	105079		
	<b>Part No.</b>	103061	<b>Ref. No.</b> 770319560
	burner cap D ø 100mm		
	<b>Part No.</b>	104093	<b>Ref. No.</b> 270200170 770324790
	venturi C/D		
	<b>Part No.</b>	104096	<b>Ref. No.</b> 241202412
	burner holder with nozzle holder connection M20x1.5		
	<b>Part No.</b>	105068	<b>Ref. No.</b> 741312350
	air mixing sleeve		

	1		
<b>Part No.</b>	105144	<b>Ref. No.</b>	290202870
<b>description</b>	burner head for burner cap ø 100mm		

	1		
<b>Part No.</b>	104096	<b>Ref. No.</b>	241202412
<b>description</b>	burner holder with nozzle holder connection M20x1.5		
<b>For models:</b>	64-020T-64-040T, 64-040FCE, 64-040FE, 64-040F-FV, 64-222F, 64-222FCE, 64-222FE, 64-222T, 700-020A-C-T, 700-040A-C-T, 700-040FB, 700-040FEB, 700-138A-C-T, 700-138FBA, 700-138FEBA, 700-162A-C-T, 700-162FBA, 700-162FEBA, 700-162FG, 700-222A-C, 700-222FB, 700-222FEB, 700-222T, 700-224A-C, 700-224FBA, 700-224FEBA, 700-224FG, 700-224T, 900-020A-C-T, 900-040A-C-T, 900-040F, 900-040FE, 900-138A-C-T, 900-138FA, 900-138FEA, 900-162A-C-T, 900-162FA, 900-162FEA, 900-162FG, 900-182F, 900-182FE, 900-302		
<b>accessories for</b>	104096		
	<b>Part No.</b>	101250	<b>Ref. No.</b> 270201680
	union nut thread M20x1.5 for pipe ø 10mm		
	<b>Part No.</b>	101278	<b>Ref. No.</b> —
	olive for pipe ø 10mm Qty 1 pcs		
	<b>Part No.</b>	104091	<b>Ref. No.</b> 790300799
	burner head D ø 124mm for burner cap ø 80mm suitable for 50, 90, 92, 110 series (old)		
	<b>Part No.</b>	104093	<b>Ref. No.</b> 270200170 770324790
	venturi C/D		
	<b>Part No.</b>	105060	<b>Ref. No.</b> 760305080 764305190
	burner head C for burner cap ø 60mm suitable for 60, 62 series		
	<b>Part No.</b>	105062	<b>Ref. No.</b> 760311640
	venturi C		
	<b>Part No.</b>	105068	<b>Ref. No.</b> 741312350
	air mixing sleeve		
	<b>Part No.</b>	105076	<b>Ref. No.</b> 790300789
	burner head C for burner cap ø 60mm suitable for 70, 90, 92 series (old)		
	<b>Part No.</b>	105079	<b>Ref. No.</b> 770336760
	burner head D ø 100mm		
	<b>Part No.</b>	105091	<b>Ref. No.</b> 770339300
	burner head C for burner cap ø 60mm		
	<b>Part No.</b>	105098	<b>Ref. No.</b> 770336750
	burner head D for burner cap ø 80mm		
	<b>Part No.</b>	105099	<b>Ref. No.</b> A00419
	burner head A for burner cap ø 110mm		

Table continues overleaf



<b>accessories for</b>	104096		
	<b>Part No.</b>	105100	<b>Ref. No.</b> A00418
	burner head A for burner cap ø 110mm		
	<b>Part No.</b>	105119	<b>Ref. No.</b> A00420
	burner head B for burner cap ø 90mm		

	1		
<b>Part No.</b>	105077	<b>Ref. No.</b>	270204230 290200460
<b>description</b>	burner ring C for burner cap ø 60mm		
<b>accessories for</b>	105077		
	<b>Part No.</b>	104093	<b>Ref. No.</b> 270200170 770324790
	venturi C/D		
	<b>Part No.</b>	104096	<b>Ref. No.</b> 241202412
	burner holder with nozzle holder connection M20x1.5		
	<b>Part No.</b>	105068	<b>Ref. No.</b> 741312350
	air mixing sleeve		
	<b>Part No.</b>	105076	<b>Ref. No.</b> 790300789
	burner head C for burner cap ø 60mm suitable for 70, 90, 92 series (old)		
	<b>Part No.</b>	105078	<b>Ref. No.</b> 290200450
	burner cap C ø 60mm		
	<b>Part No.</b>	105091	<b>Ref. No.</b> 770339300
	burner head C for burner cap ø 60mm		

	1		
<b>Part No.</b>	105082	<b>Ref. No.</b>	A00003
<b>description</b>	burner ring C with burner cap ø60mm		
<b>For models:</b>	64-020T-64-040T, 64-040FCE, 64-040FE, 64-040F-FV, 64-222F, 64-222FCE, 64-222FE, 64-222T, 700-020A-C-T, 700-040A-C-T, 700-040FB, 700-040FEB, 700-138A-C-T, 700-138FBA, 700-138FEBA, 700-162A-C-T, 700-162FBA, 700-162FEBA, 700-162FG, 700-222A-C, 700-222FB, 700-222FEB, 700-222T, 700-224A-C, 700-224FBA, 700-224FEBA, 700-224FG, 700-224T, 900-302		

	1		
<b>Part No.</b>	105147	<b>Ref. No.</b>	A00024
<b>description</b>	nozzle holder L 61mm M10x1 gas inlet 1/2" gas outlet M14x1		
<b>For models:</b>	110-120AL-ALR, 110-120TL-TLR, 110-122AL-ALR, 110-122ALC, 110-122FELC, 110-122FEL-FELR, 110-122FLC, 110-122FL-FLR, 110-122TL, 110-122TL-TLR, 110-200A-T, 110-200F, 110-200FE, 500-120AL-AR, 500-120ALC, 500-120TLC, 500-120TL-TR, 500-122AL-ALR-AR, 500-122ALC, 500-122TLC, 500-122TL-TLR-TR, 500-125A-126A, 500-601A, 500-750A, 500-800A, 64-040F-FV, 64-120TLC, 64-120TL-TR, 64-122TL, 64-122TLC, 64-122TLR-TR, 64-125T-126T, 64-130TL-TR, 64-132TL TLR-TR, 64-222F, 64-600T-603T, 700-040FB, 700-120AL-AR-CL, 700-120ALC-CLC, 700-120CR-TL, 700-120TLC, 700-120TR, 700-122AL, 700-122ALC, 700-122ALR-AR-CL, 700-122CLC, 700-122CLR-CR-TL, 700-122TLC, 700-122TLR-TR, 700-125A-C...(Other models you can see in the webshop)		

	1		
<b>Part No.</b>	105364	<b>Ref. No.</b>	A00176
<b>description</b>	round burner ø 190mm		
<b>For models:</b>	110-200A-T, 110-200F, 110-200FE, 700-138A-C-T, 700-138FBA, 700-138FEBA, 700-200A-C-T, 700-200FB, 700-200FEB, 900-138A-C-T, 900-138FA, 900-138FEA, 900-200A-C-T, 900-200F, 900-200FE, 920-200A-T, 920-200F, 920-200FE		

	1		
<b>Part No.</b>	104093	<b>Ref. No.</b>	270200170 770324790
<b>description</b>	venturi C/D		
<b>For models:</b>	64-222F, 64-222FCE, 64-222FE, 64-222T, 700-020A-C-T, 700-040A-C-T, 700-040FB, 700-040FEB, 700-138A-C-T, 700-138FBA, 700-138FEBA, 700-162A-C-T, 700-162FBA, 700-162FEBA, 700-162FG, 700-222AC, 700-222FB, 700-222FEB, 700-222T, 700-224A-C, 700-224FBA, 700-224FEBA, 700-224FG, 700-224T, 900-020A-C-T, 900-040A-C-T, 900-040F, 900-040FE, 900-138A-C-T, 900-138FA, 900-138FEA, 900-162A-C-T, 900-162FA, 900-162FEA, 900-162FG, 900-182F, 900-182FE		
<b>accessories for</b>	104093		
	<b>Part No.</b>	104091	<b>Ref. No.</b> 790300799
	burner head D ø 124mm for burner cap ø 80mm suitable for 50, 90, 92, 110 series (old)		
	<b>Part No.</b>	104096	<b>Ref. No.</b> 241202412
	burner holder with nozzle holder connection M20x1.5		
	<b>Part No.</b>	105068	<b>Ref. No.</b> 741312350
	air mixing sleeve		
	<b>Part No.</b>	105076	<b>Ref. No.</b> 790300789
	burner head C for burner cap ø 60mm suitable for 70, 90, 92 series (old)		
	<b>Part No.</b>	105079	<b>Ref. No.</b> 770336760
	burner head D ø 100mm		
	<b>Part No.</b>	105091	<b>Ref. No.</b> 770339300
	burner head C for burner cap ø 60mm		
	<b>Part No.</b>	105098	<b>Ref. No.</b> 770336750
	burner head D for burner cap ø 80mm		
	<b>Part No.</b>	105099	<b>Ref. No.</b> A00419
	burner head A for burner cap ø 110mm		
	<b>Part No.</b>	105100	<b>Ref. No.</b> A00418
	burner head A for burner cap ø 110mm		
	<b>Part No.</b>	105119	<b>Ref. No.</b> A00420
	burner head B for burner cap ø 90mm		



pan supports



1

<b>Part No.</b>	210028	<b>Ref. No.</b>	270203609
<b>description</b>	pan support W 287mm L 387mm H 46mm suitable for GICO		

reducers for pan supports



1

<b>Part No.</b>	210001	<b>Ref. No.</b>	241200480
<b>description</b>	reducer for pan support L 265mm W 265mm SS suitable for universal		

accessories

reducers for pan supports



1

<b>Part No.</b>	210001	<b>Ref. No.</b>	241200480
<b>description</b>	reducer for pan support L 265mm W 265mm SS suitable for universal		

bar burners

bar burners



1

<b>Part No.</b>	105353	<b>Ref. No.</b>	A00271
<b>description</b>	bar burner 2 row L 370mm W 178mm ømm H 145mm griddle		



1

<b>Part No.</b>	105148	<b>Ref. No.</b>	A00422
<b>description</b>	bar burner 2 row L 380mm W 245mm ømm H 150mm fryer		
<b>For models:</b>	700-601A-S, 700-602A-S, 900-601A-S, 900-602A-S		



1

<b>Part No.</b>	105354	<b>Ref. No.</b>	A00272
<b>description</b>	bar burner 2 row L 400mm W 205mm ømm H 150mm griddle		



1

<b>Part No.</b>	107147	<b>Ref. No.</b>	A00226
<b>description</b>	bar burner 2 row L 440mm W 250mm ømm H 50mm		



1

<b>Part No.</b>	105363	<b>Ref. No.</b>	260202640 A00273
<b>description</b>	bar burner 2 row L 445mm W 200mm ømm H 50mm chargrill		



1

<b>Part No.</b>	105149	<b>Ref. No.</b>	A00423
<b>description</b>	bar burner 2 row L 470mm W 245mm ømm H 150mm fryer		
<b>For models:</b>	700-604A-605A, 900-604A-S, 900-605A-S, 920-604A-S		



1

<b>Part No.</b>	104342	<b>Ref. No.</b>	A00274
<b>description</b>	bar burner 2 row L 510mm W 200mm ømm H 45mm chargrill		





1

<b>Part No.</b>	105351	<b>Ref. No.</b>	A00162
<b>description</b>	bar burner 2 row L 510mm W 250mm ømm H 45mm gas range		
<b>For models:</b>	700-040FB, 700-138FBA, 700-162FBA, 700-162FG, 700-200FB, 700-222FB, 700-224FBA, 700-224FG, 700-401B		







			
1			
<b>Part No.</b>	105355	<b>Ref. No.</b>	A00110 A00193
<b>description</b>	bar burner 2 row L 530mm W 250mm ømm H 35mm griddle		
<b>For models:</b>	920-120AL-AR, 920-120ALC, 920-120TLC, 920-120TL-TR, 920-122ALALR-AR, 920-122ALC, 920-122FELC, 920-122FEL-FELR-FER, 920-122FELR, 920-122FER, 920-122FLC, 920-122FL-FLR-FR, 920-122TLC, 920-122TL-TLR-TR		

			
1			
<b>Part No.</b>	105352	<b>Ref. No.</b>	A00161
<b>description</b>	bar burner 2 row L 650mm W 235mm ømm H 40mm gas range		
<b>For models:</b>	900-040F, 900-138FA, 900-162FA, 900-162FG, 900-182F, 900-200F, 900-401, 920-122FLC, 920-122FL-FLR-FR, 920-200F		

			
1			
<b>Part No.</b>	105152	<b>Ref. No.</b>	770118950
<b>description</b>	bar burner ø 40mm Wmm Hmm L 309mm flange width 50mm gas range flange ø 61mm		
<b>For models:</b>	64-040F-FV, 64-222F, 64-900T, 700-400A-C-T, 700-402A-C-T		

			
1			
<b>Part No.</b>	105142	<b>Ref. No.</b>	770118960
<b>description</b>	bar burner ø 40mm Wmm Hmm L 409mm flange width 50mm griddle flange ø 61mm		
<b>For models:</b>	900-400A-C-T, 900-402A-C-T, 920-400A-T, 920-402A-T		

			
1			
<b>Part No.</b>	104155	<b>Ref. No.</b>	4323105
<b>description</b>	bar burner ø 40mm Wmm Hmm L 460mm 5.8kW frying pan		
<b>For models:</b>	900-622, 900-900		

			
1			
<b>Part No.</b>	105145	<b>Ref. No.</b>	790117780
<b>description</b>	bar burner ø 40mm Wmm Hmm L 510mm with retainer for nozzle rod flange width 50mm flange length 70mm griddle		

			
1			
<b>Part No.</b>	105361	<b>Ref. No.</b>	4323117
<b>description</b>	bar burner ø 50mm L 463mm flange width 71mm pasta cooker flange ø 75mm		

			
1			
<b>Part No.</b>	105156	<b>Ref. No.</b>	270203350
<b>description</b>	bar burner ø 50mm Wmm Hmm L 185mm flange width 71mm kettle flange ø 75mm		
<b>For models:</b>	700-508		

			
1			
<b>Part No.</b>	105366	<b>Ref. No.</b>	293200290
<b>description</b>	bar burner ø 50mm Wmm Hmm L 298mm flange width 65mm flange length 71mm		

			
1			
<b>Part No.</b>	105154	<b>Ref. No.</b>	770120430
<b>description</b>	bar burner ø 50mm Wmm Hmm L 308mm flange width 71mm pasta cooker flange ø 75mm		
<b>For models:</b>	500-750A, 700-750A-S, 700-800A-S		





			
1			
<b>Part No.</b>	105359	<b>Ref. No.</b>	4323115
<b>description</b>	bar burner ø 50mm Wmm Hmm L 325mm flange width 71mm frying pan flange ø 75mm		
<b>For models:</b>	900-503, 920-503		

			
1			
<b>Part No.</b>	105155	<b>Ref. No.</b>	790118660
<b>description</b>	bar burner ø 50mm Wmm Hmm L 465mm with retainer for nozzle rod with flange flange width 70mm flange length 75mm pasta cooker		
<b>For models:</b>	900-750A-S, 900-800A-S, 920-750A-S		

			
1			
<b>Part No.</b>	105365	<b>Ref. No.</b>	293200270
<b>description</b>	bar burner ø 50mm Wmm Hmm L 615mm flange width 65mm flange length 71mm		

			
1			
<b>Part No.</b>	105358	<b>Ref. No.</b>	250200190
<b>description</b>	bar burner ø 50mm Wmm Hmm L 715mm with bolt M5x12 flange with bolt M4 flange width 65mm flange length 71mm pasta cooker		
<b>For models:</b>	500-800A		

			
1			
<b>Part No.</b>	105157	<b>Ref. No.</b>	293201090
<b>description</b>	bar burner ø 50mm Wmm Hmm L 775mm flange with bolt M4 flange width 65mm flange length 71mm		

			
1			
<b>Part No.</b>	105151	<b>Ref. No.</b>	A00169
<b>description</b>	bar burner ømm W 40mm H 35mm L 490mm		

			
1			
<b>Part No.</b>	105150	<b>Ref. No.</b>	A00290
<b>description</b>	bar burner ømm W 42mm H 38mm L 375mm bain marie		

tube burners

			
1			
<b>Part No.</b>	105357	<b>Ref. No.</b>	A00174
<b>description</b>	tubular burner L 225mm W 55mm H 54mm mounting pos. left for fryer oval		

			
1			
<b>Part No.</b>	105356	<b>Ref. No.</b>	A00173
<b>description</b>	tubular burner L 225mm W 55mm H 54mm mounting pos. right for fryer oval		



accessories

nozzle holders



1	<b>Part No.</b>	105147	<b>Ref. No.</b>	A00024
	<b>description</b>	nozzle holder L 61mm M10x1 gas inlet 1/2" gas outlet M14x1		
<b>For models:</b>	110-120AL-ALR, 110-120TL-TLR, 110-122AL-ALR, 110-122ALC, 110-122FELC, 110-122FEL-FELR, 110-122FLC, 110-122FL-FLR, 110-122TL, 110-122TL-TLR, 110-200A-T, 110-200F, 110-200FE, 500-120AL-AR, 500-120ALC, 500-120TLC, 500-120TL-TR, 500-122AL-ALR-AR, 500-122ALC, 500-122TLC, 500-122TL-TLR-TR, 500-125A-126A, 500-601A, 500-750A, 500-800A, 64-040F-FV, 64-120TLC, 64-120TL-TR, 64-122TL, 64-122TLC, 64-122TLR-TR, 64-125T-126T, 64-130TL-TR, 64-132TL TLR-TR, 64-222F, 64-600T-603T, 700-040FB, 700-120AL-AR-CL, 700-120ALC-CLC, 700-120CR-TL, 700-120TLC, 700-120TR, 700-122AL, 700-122ALC, 700-122ALR-AR-CL, 700-122CLC, 700-122CLR-CR-TL, 700-122TLC, 700-122TLR-TR, 700-125A-C...(Other models you can see in the webshop)			

gas nozzles

main nozzles

gas nozzles M10x1



1	<b>Part No.</b>	100973	<b>Ref. No.</b>	290201330
	<b>description</b>	gas injector thread M10x1 bore ø 0.8mm L 30mm WS 12		



1	<b>Part No.</b>	106400	<b>Ref. No.</b>	270200461
	<b>description</b>	gas injector thread M10x1 bore ø 1.1mm L 30mm WS 12		



1	<b>Part No.</b>	100671	<b>Ref. No.</b>	290201400
	<b>description</b>	gas injector thread M10x1 bore ø 1.25mm L 30mm WS 12		



1	<b>Part No.</b>	106762	<b>Ref. No.</b>	290201530
	<b>description</b>	gas injector thread M10x1 bore ø 2.1mm L 30mm WS 12		



1	<b>Part No.</b>	106469	<b>Ref. No.</b>	241204941
	<b>description</b>	gas injector thread M10x1 WS 12 bore ø 2.5mm		



1	<b>Part No.</b>	106491	<b>Ref. No.</b>	241203471
	<b>description</b>	gas injector thread M10x1 WS 11 bore ø 2.1mm		



1	<b>Part No.</b>	107341	<b>Ref. No.</b>	290201890
	<b>description</b>	gas injector thread M10x1 WS 12 bore ø 0.75mm		



1	<b>Part No.</b>	100380	<b>Ref. No.</b>	241204851
	<b>description</b>	gas injector thread M10x1 WS 12 bore ø 0.7mm		





1	<b>Part No.</b>	100535	<b>Ref. No.</b>	241204861
	<b>description</b>	gas injector thread M10x1 WS 12 bore ø 0.8mm		





1	<b>Part No.</b>	102126	<b>Ref. No.</b>	270202260
	<b>description</b>	gas injector thread M10x1 WS 12 bore ø 0.9mm		





			
1			
<b>Part No.</b>	100382	<b>Ref. No.</b>	270202170
<b>description</b>	gas injector thread M10x1 WS 12 bore ø 1.05mm		

			
1			
<b>Part No.</b>	100540	<b>Ref. No.</b>	241202341
<b>description</b>	gas injector thread M10x1 WS 12 bore ø 1.2mm		

			
1			
<b>Part No.</b>	107544	<b>Ref. No.</b>	241204891
<b>description</b>	gas injector thread M10x1 WS 12 bore ø 1.35mm		

			
1			
<b>Part No.</b>	100387	<b>Ref. No.</b>	241204901
<b>description</b>	gas injector thread M10x1 WS 12 bore ø 1.45mm		

			
1			
<b>Part No.</b>	102151	<b>Ref. No.</b>	270200140
<b>description</b>	gas injector thread M10x1 WS 12 bore ø 1.4mm		

			
1			
<b>Part No.</b>	100661	<b>Ref. No.</b>	290201850
<b>description</b>	gas injector thread M10x1 WS 12 bore ø 1.65mm		

			
1			
<b>Part No.</b>	100537	<b>Ref. No.</b>	270200910
<b>description</b>	gas injector thread M10x1 WS 12 bore ø 1mm		

## pilot burner nozzles

## pilot burner nozzles POLIDORO

			
1			
<b>Part No.</b>	100208	<b>Ref. No.</b>	4372022
<b>description</b>	pilot burner nozzle POLIDORO LPG code 20 bore ø 0.2mm Qty 1 pcs		

			
1			
<b>Part No.</b>	106763	<b>Ref. No.</b>	4372027
<b>description</b>	pilot burner nozzle POLIDORO natural gas code 27.2A bore ø 2x 0.27mm Qty 1 pcs		

## pilot burner nozzles SIT

## 100 series

			
1			
<b>Part No.</b>	100245	<b>Ref. No.</b>	4370001
<b>description</b>	pilot burner nozzle LPG code 20 bore ø 0.2mm Qty 1 pcs thread M8x0.75		

			
1			
<b>Part No.</b>	107170	<b>Ref. No.</b>	4370002
<b>description</b>	pilot burner nozzle SIT natural gas bore ø 0.35mm Qty 1 pcs		

## 140/150 series

			
1			
<b>Part No.</b>	100205	<b>Ref. No.</b>	43702019
<b>description</b>	pilot burner nozzle SIT LPG code 19 bore ø 0.23/0.26mm Qty 1 pcs suitable for SIT 150 series		

			
1			
<b>Part No.</b>	100206	<b>Ref. No.</b>	43702036
<b>description</b>	pilot burner nozzle SIT natural gas code 36 bore ø 0.60/0.55mm Qty 1 pcs suitable for SIT 150 series		





			
1			
<b>Part No.</b>	106761	<b>Ref. No.</b>	43701037
<b>description</b>	pilot burner nozzle SIT natural gas code 37 bore ø 0.55mm Qty 1 pcs		

160 series			
			
1			
<b>Part No.</b>	107172	<b>Ref. No.</b>	43701025
<b>description</b>	pilot burner nozzle SIT LPG code 25 Qty 1 pcs		

			
1			
<b>Part No.</b>	107650	<b>Ref. No.</b>	43703030
<b>description</b>	pilot burner nozzle SIT LPG code 30 Qty 1 pcs		

			
1			
<b>Part No.</b>	107173	<b>Ref. No.</b>	43701035
<b>description</b>	pilot burner nozzle SIT natural gas code 35 Qty 1 pcs suitable for 160 series nozzle ø 0.35mm		

			
1			
<b>Part No.</b>	107174	<b>Ref. No.</b>	43701041
<b>description</b>	pilot burner nozzle SIT natural gas code 41 Qty 1 pcs		

			
1			
<b>Part No.</b>	107175	<b>Ref. No.</b>	43703051
<b>description</b>	pilot burner nozzle SIT natural gas code 51 Qty 1 pcs suitable for 160 series		

bypass nozzles

bypass nozzles PEL20/21			
			
1			
<b>Part No.</b>	100550	<b>Ref. No.</b>	4399206
<b>description</b>	bypass nozzle type PEL20/21 bore ø 0.55mm thread M5x0.5		

			
1			
<b>Part No.</b>	100526	<b>Ref. No.</b>	4399209
<b>description</b>	bypass nozzle type PEL20/21 bore ø 0.5mm thread M5x0.5		

			
1			
<b>Part No.</b>	100548	<b>Ref. No.</b>	4399208
<b>description</b>	bypass nozzle type PEL20/21 bore ø 0.65mm thread M5x0.5		

			
1			
<b>Part No.</b>	100551	<b>Ref. No.</b>	4399260
<b>description</b>	bypass nozzle type PEL20/21 bore ø 0.6mm thread M5x0.5		

			
1			
<b>Part No.</b>	100278	<b>Ref. No.</b>	4399237
<b>description</b>	bypass nozzle type PEL20/21 bore ø 0.75mm thread M5x0.5		

			
1			
<b>Part No.</b>	100552	<b>Ref. No.</b>	4399251
<b>description</b>	bypass nozzle type PEL20/21 bore ø 0.7mm thread M5x0.5		

			
1			
<b>Part No.</b>	100527	<b>Ref. No.</b>	4399239
<b>description</b>	bypass nozzle type PEL20/21 bore ø 0.85mm thread M5x0.5		

			
1			
<b>Part No.</b>	100394	<b>Ref. No.</b>	4399247
<b>description</b>	bypass nozzle type PEL20/21 bore ø 1.25mm thread M5x0.5		

			
1			
<b>Part No.</b>	100534	<b>Ref. No.</b>	4399238
<b>description</b>	bypass nozzle type PEL20/21 bore ø 1.4mm thread M5x0.5		





1			
<b>Part No.</b>	100529	<b>Ref. No.</b>	4399250
<b>description</b>	bypass nozzle type PEL20/21 bore $\varnothing$ 1mm thread M5x0.5		



## bypass nozzles PEL23/24

1			
<b>Part No.</b>	106760	<b>Ref. No.</b>	4399235
<b>description</b>	bypass nozzle type PEL23/24 bore $\varnothing$ 2.8mm thread M8x0.5		



## auxiliary gas parts

## screw connections

## olives

1				
<b>Part No.</b>	101249	<b>Ref. No.</b>	270201580	
<b>description</b>	olive for pipe $\varnothing$ 10mm Qty 1 pcs			
<b>accessories for</b>	101249			
	<b>Part No.</b>	101250	<b>Ref. No.</b>	270201680
	union nut thread M20x1.5 for pipe $\varnothing$ 10mm			

## union nuts

1				
<b>Part No.</b>	101250	<b>Ref. No.</b>	270201680	
<b>description</b>	union nut thread M20x1.5 for pipe $\varnothing$ 10mm			
<b>accessories for</b>	101250			
	<b>Part No.</b>	101249	<b>Ref. No.</b>	270201580
	olive for pipe $\varnothing$ 10mm Qty 1 pcs			

## union screws

1			
<b>Part No.</b>	100904	<b>Ref. No.</b>	4392050
<b>description</b>	locking screw M10x1 for pipe $\varnothing$ 4mm Qty 1 pcs		

## pressure switches

1			
<b>Part No.</b>	541073	<b>Ref. No.</b>	6440001
<b>description</b>	pressure control $\varnothing$ 45mm pressure range adjustable 5-20mbar pressure connection vertical gas technology connection 1/4" pressure connection $\varnothing$ 1/4"mm		

## equipment-specific units

## for pasta cookers

1			
<b>Part No.</b>	520505	<b>Ref. No.</b>	A00465
<b>description</b>	ball valve ET 3/8" for pasta cooker shaft $\varnothing$ 10x8mm		
<b>For models:</b>	700-750A-S, 700-755A-S, 700-800A-S, 700-855A-S, 900-750A-S, 900-755A-S, 900-800A-S, 900-855A-S, 920-750A-S, 920-755A-S		

1			
<b>Part No.</b>	694345	<b>Ref. No.</b>	750309770
<b>description</b>	coupling for water valve int. $\varnothing$ 1 10mm int. $\varnothing$ 2 22mm ED $\varnothing$ 20/28mm L 34mm WS 24 thread M5		

## for dishwashers

## drain and intake components

## miscellaneous

## overflow pipes

1			
<b>Part No.</b>	540268	<b>Ref. No.</b>	711106890
<b>description</b>	overflow pipe		



knobs

producer-specific knobs

GICO



1

<b>Part No.</b>	110875	<b>Ref. No.</b>	293202250 A00250
<b>description</b>	knob switch zero mark ø 54mm shaft ø 6x4.6mm shaft flat upper black		
<b>For models:</b>	64-040FCE, 64-050FCE, 64-222FCE		



1

<b>Part No.</b>	110833	<b>Ref. No.</b>	790106630
<b>description</b>	knob		



1

<b>Part No.</b>	110039	<b>Ref. No.</b>	790106610
<b>description</b>	knob gas tap with ignition flame ø 60mm shaft ø 10x8mm shaft left		



1

<b>Part No.</b>	110834	<b>Ref. No.</b>	790106620
<b>description</b>	knob gas tap with ignition flame ø 60mm shaft ø 8x6.5mm shaft flat upper		



1

<b>Part No.</b>	110857	<b>Ref. No.</b>	790106980
<b>description</b>	knob gas thermostat 1-8 ø 60mm shaft ø 8x6.5mm shaft flat upper black		



1

<b>Part No.</b>	110846	<b>Ref. No.</b>	790106900
<b>description</b>	knob switch 0-1-0-1 ø 60mm shaft ø 6x4.6mm shaft flat upper		



1

<b>Part No.</b>	110837	<b>Ref. No.</b>	790106910
<b>description</b>	knob switch 4-position ø 60mm shaft ø 6x4.6mm shaft flat upper black		



1

<b>Part No.</b>	110838	<b>Ref. No.</b>	790106920
<b>description</b>	knob switch 7-position ø 60mm shaft ø 6x4.6mm shaft flat upper		



1

<b>Part No.</b>	110850	<b>Ref. No.</b>	790106930
<b>description</b>	knob thermostat t.max. 110°C ø 60mm shaft ø 6x4.6mm shaft flat upper black temperature range 30-110°C		



1

<b>Part No.</b>	110842	<b>Ref. No.</b>	790106940
<b>description</b>	knob thermostat t.max. 180°C ø 60mm shaft ø 6x4.6mm shaft flat lower black temperature range 100-180°C		

1

<b>Part No.</b>	110853	<b>Ref. No.</b>	790107000
<b>description</b>	knob thermostat t.max. 300°C ø 60mm shaft ø 6x4.6mm shaft flat upper black temperature range 50-300°C		



1

<b>Part No.</b>	110854	<b>Ref. No.</b>	790109210
<b>description</b>	knob thermostat t.max. 300°C ø 60mm shaft ø 6x4.6mm shaft flat upper black temperature range 50-300°C thermostat		



1

<b>Part No.</b>	110841	<b>Ref. No.</b>	790106950
<b>description</b>	knob thermostat t.max. 300°C ø 60mm shaft ø 6x4.6mm shaft flat upper temperature range 50-300°C rotation 270° thermostat		



1

<b>Part No.</b>	110845	<b>Ref. No.</b>	790106970
<b>description</b>	knob thermostat t.max. 90°C ø 60mm shaft ø 6x4.6mm shaft flat upper black temperature range 30-90°C		



1

<b>Part No.</b>	110849	<b>Ref. No.</b>	760106080
<b>description</b>	knob water ø 60mm shaft ø 6x4.6mm shaft flat upper		



1

<b>Part No.</b>	110011	<b>Ref. No.</b>	790119450
<b>description</b>	knob gas tap with ignition flame ø 60mm shaft ø 10x8mm shaft flat left black		
<b>For models:</b>	110-200A-T, 110-200F, 110-200FE, 500-125A-126A, 500-750A, 500-800A, 700-125A-C, 700-126A-C, 700-127A-C, 700-138A-C-T, 700-138FBA, 700-138FEBA, 700-200A-C-T, 700-200FB, 700-200FEB, 700-224FG, 700-508, 700-750A-S, 700-800A-S, 900-125A-C, 900-126AC, 900-127A-C, 900-138A-C-T, 900-138FA, 900-138FEA, 900-200A-C-T, 900-200F, 900-200FE, 900-503, 900-506, 900-750A-S, 900-800A-S, 900-301, 920-200A-T, 920-200F, 920-200FE, 920-503, 920-506, 920-750A-S		



1

<b>Part No.</b>	112909	<b>Ref. No.</b>	790119460
<b>description</b>	knob gas tap with ignition flame ø 60mm shaft ø 8x6.5mm shaft flat upper		
<b>For models:</b>	64-125T-126T, 64-130TL-TR, 64-132TL-TLR-TR, 64-222F, 64-222FCE, 64-222FE, 64-222T, 700-020A-C-T, 700-040A-C-T, 700-040FB, 700-040FEB, 700-125T, 700-126T, 700-127T, 700-130AL-AR, 700-130CL-CR, 700-130TL-TR, 700-132AL-AR, 700-132ALR, 700-132CL-CR, 700-132CLR, 700-132TLR, 700-132TL-TR, 700-138A-C-T, 700-138FBA, 700-138FEBA, 700-162A-C-T, 700-162FBA, 700-162FEBA, 700-162FG, 700-222A-C, 700-222FB, 700-222FEB, 700-222T, 700-224A-C, 700-224FBA, 700-224FEBA, 700-224FG, 700-224T, 900-020A-C-T, 900-040A-C-T, 900-040F, 900-040FE, 900-125T, 900-126T, 900-127T, 900-130AL-AR, 900-130CL-CR, 900-130TL-TR, 900-132AL-ALR-AR...(Other models you can see in the webshop)		



1

<b>Part No.</b>	112103	<b>Ref. No.</b>	790119470
<b>description</b>	knob gas tap without ignition flame ø 60mm shaft ø 8x6.5mm shaft flat upper black		
<b>For models:</b>	64-020T-64-040T, 64-040FCE, 64-040FE, 64-040F-FV, 64-222F, 64-222FCE, 64-222FE, 64-222T		

1

<b>Part No.</b>	110863	<b>Ref. No.</b>	790106960 790119530
<b>description</b>	knob graduated ø 60mm shaft ø 6x4.6mm shaft flat upper black		
<b>For models:</b>	110-032A-T, 110-038A, 110-052A, 110-052FE, 110-052T, 110-058A, 500-038A, 500-039A, 700-038A-058A, 700-039A, 700-052A-C-T, 700-052FEB, 700-054A, 700-054C, 700-054FEB, 700-054T, 700-325A-326A, 70-820, 70-840, 900-038A-058A, 900-038AM-058AM, 900-039A, 900-052A-C-T, 900-052FE, 900-054A-C-T, 900-054FE, 900-325A-326A, 920-032A-T, 920-038A, 920-052A-T, 920-052FE, 920-058A, ES-023N, ES-121NVC, ES-121NVCG, ES-151NVC, ES-151NVCG, ES-181NVC, ES-181NVCG, ES-702N, ES-IR090C-I, ES-IR120C-I, ES-IR150C-I, ES-IR180C-I		



2

<b>Part No.</b>	110871	<b>Ref. No.</b>	790119500 A00428
<b>description</b>	knob switch 1-0-1 ø 60mm shaft ø 6x4.6mm shaft flat left black		



1

<b>Part No.</b>	110868	<b>Ref. No.</b>	790119490
<b>description</b>	knob switch 1-0-1 ø 60mm shaft ø 6x4.6mm shaft flat upper black		
<b>For models:</b>	110-500A-T, 700-500A-C-T, 700-542A-C-T, 900-500A-C-T, 900-542A-C-T, 920-500A-T, 920-542A-T, 9ES-122N, 9ES-122NG, 9ES-152N, 9ES-152NG, 9ES-182N, 9ES-182NG		



1

<b>Part No.</b>	111749	<b>Ref. No.</b>	790119510
<b>description</b>	knob switch 4-position ø 60mm shaft ø 6x4.6mm shaft flat upper black		
<b>For models:</b>	110-030A-T, 110-050A-T, 110-050FE, 500-030A-T, 500-050A-T, 500-050FE, 64-755T, 700-035A-C-T, 700-055A-C-T, 700-055FEB, 700-528, 900-030A-C-T, 900-050A-C-T, 900-050FE, 900-172A-C-T, 900-172FEA, 900-521-522, 900-523, 900-526, 90-821, 920-030A-T, 920-050A-T, 920-050FE, 920-172A-T, 920-172FEA, 920-523, 920-526		



1

<b>Part No.</b>	112199	<b>Ref. No.</b>	790106910
<b>description</b>	knob switch 4-position ø 60mm shaft ø 6x4.6mm shaft flat upper black		



1

<b>Part No.</b>	112163	<b>Ref. No.</b>	790119520
<b>description</b>	knob switch 7-position ø 60mm shaft ø 6x4.6mm shaft flat upper black		
<b>For models:</b>	64-030T, 64-050FCE, 64-050FE-FEV, 64-050T, 700-030A-C-T, 700-050A-C-T, 700-050FEB		



1

<b>Part No.</b>	110852	<b>Ref. No.</b>	790109390 790119590
<b>description</b>	knob thermostat t.max. 110°C ø 60mm shaft ø 6x4.6mm shaft flat upper black temperature range 30-110°C		



1

<b>Part No.</b>	111750	<b>Ref. No.</b>	790119560
<b>description</b>	knob thermostat t.max. 180°C ø 60mm shaft ø 6x4.6mm shaft flat upper black		
<b>For models:</b>	500-701A, 64-700T, 64-703T, 700-701A-S, 700-702A-S, 700-704A-S, 700-705A-S, 700-708A-S, 900-701A-S, 900-702A-S, 900-704A-S, 900-705A-S, 900-706A-S, 920-704A-S		





			
1			
<b>Part No.</b>	111714	<b>Ref. No.</b>	790119570
<b>description</b>	knob thermostat t.max. 300°C 50-300°C ø 60mm shaft ø 6x4.6mm shaft flat upper black		
<b>For models:</b>	110-050FE, 110-052FE, 110-057FE, 110-122FELC, 110-122FEL-FELR, 110-200FE, 110-320AL-ALR, 110-320TL-TLR, 110-322AL-ALC-ALR, 110-322FEL-FELC-FELR, 110-322TL-TLC-TLR, 500-320AL-ALC-AR, 500-320TL-TLC-TR, 500-322AL-ALC-ALR-AR, 500-322TL-TLC-TLR TR, 64-320TL-TLC-TR, 64-322TL-TLC-TLR-TR, 700-320AL-ALC-AR, 700-320CL-CLC-CR, 700-320TL-TLC-TR, 700-322AL-ALC-ALR-AR, 700-322CL-CLC-CLR-CR, 700-322TL-TLC-TLR-TR, 700-960A-D, 700-962A, 900-040FE, 900-050FE, 900-052FE, 900-054FE, 900-057FE, 900-138FEA, 900-162FEA, 900-172FEA, 900-182FE, 900-200FE, 900-320AL-ALC, 900-320AR, 900-320CL-CLC-CR, 900-320TL-TLC-TR, 900-322AL-ALC, 900-322ALR-AR, 900-322CL-CLC, 900-322CLR-CR, 900-322TLR-TR, 900-322TL-TLC, 900-411-413, 900-960A, 900-962A, 920-050FE, 920-052FE...(Other models you can see in the webshop)		

			
1			
<b>Part No.</b>	112251	<b>Ref. No.</b>	790119550
<b>description</b>	knob thermostat t.max. 90°C ø 60mm shaft ø 6x4.6mm shaft flat upper black temperature range 30-90°C rotation 270°		
<b>For models:</b>	110-500A-T, 500-500A, 64-500T, 64-519T, 64-520T, 64-542T, 700-500A-C-T, 700-519A-C-T, 700-520T, 700-542A-C-T, 900-500A-C-T, 900-542A-C-T, 920-500A-T, 920-542A-T, 9ES-122N, 9ES-122NG, 9ES-152N, 9ES-152NG, 9ES-182N, 9ES-182NG, ES-121NVC, ES-121NVCG, ES-151NVC, ES-151NVCG, ES-181NVC, ES-181NVCG, ES-424NC, ES-828NC, ES-861NC, ES-891NC		

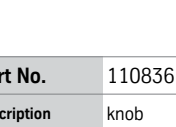
			
2			
<b>Part No.</b>	110873	<b>Ref. No.</b>	790119580 A00427
<b>description</b>	knob thermostat t.max. 300°C ø 60mm shaft ø 6x4.6mm shaft flat left black temperature range 50-300°C		
<b>For models:</b>	64-930T, 700-622, 700-632, 700-900, 700-930, 900-622, 900-632, 900-642, 900-652, 900-900, 900-930, 900-940, 900-950, 920-622, 920-632, 920-642, 920-652, 920-900, 920-930, 920-940, 920-950		

			
1			
<b>Part No.</b>	110836	<b>Ref. No.</b>	790109350
<b>description</b>	knob		

			
1			
<b>Part No.</b>	110866	<b>Ref. No.</b>	790115900
<b>description</b>	knob thermostat t.max. 300°C ø 60mm shaft ø 6x4.6mm shaft flat upper black temperature range 50-300°C		

			
1			
<b>Part No.</b>	110835	<b>Ref. No.</b>	790109350
<b>description</b>	knob gas tap with ignition flame ø 60mm shaft ø 10x8mm shaft flat left		
<b>accessories for</b>	110835		
	<b>Part No.</b>	110832	<b>Ref. No.</b> 290202430
	knob spring		

			
1			
<b>Part No.</b>	110867	<b>Ref. No.</b>	790115910 790119600
<b>description</b>	knob thermostat t.max. 300°C ø 60mm shaft ø 6x4.6mm shaft flat upper black temperature range 50-300°C		
<b>For models:</b>	500-050FE, 700-040FEB, 700-050FEB, 700-054A, 700-054FEB, 700-055FEB, 700-057FEB, 700-138FEBA, 700-162FEBA, 700-200FEB, 700-222FEB, 700-224FEBA, 700-411B		

			
1			
<b>Part No.</b>	110859	<b>Ref. No.</b>	790109340
<b>description</b>	knob gas tap with ignition flame ø 60mm shaft ø 8x6.5mm shaft flat upper		







1

<b>Part No.</b>	110864	<b>Ref. No.</b>	790109420
<b>description</b>	knob graduated ø 60mm shaft ø 6x4.6mm shaft flat upper		



1

<b>Part No.</b>	110844	<b>Ref. No.</b>	790109410
<b>description</b>	knob thermostat t.max. 180°C ø 60mm shaft ø 6x4.6mm shaft flat upper black		



1

<b>Part No.</b>	110872	<b>Ref. No.</b>	A00430
<b>description</b>	knob switch 0-1-0-1 ø 60mm shaft ø 6x4.6mm shaft flat lower		



1

<b>Part No.</b>	110843	<b>Ref. No.</b>	790109400
<b>description</b>	knob thermostat t.max. 300°C ø 60mm shaft ø 6x4.6mm shaft flat upper		



1

<b>Part No.</b>	110848	<b>Ref. No.</b>	790109360 A00430
<b>description</b>	knob switch 0-1-0-1 ø 60mm shaft ø 6x4.6mm shaft flat lower black		



1

<b>Part No.</b>	110874	<b>Ref. No.</b>	A00429
<b>description</b>	knob thermostat t.max. 300°C ø 60mm shaft ø 6x4.6mm shaft flat upper black temperature range 45-295°C		



1

<b>Part No.</b>	110839	<b>Ref. No.</b>	790109370
<b>description</b>	knob switch 4-position ø 60mm shaft ø 6x4.6mm shaft flat upper black		



1

<b>Part No.</b>	110847	<b>Ref. No.</b>	790109480
<b>description</b>	knob thermostat t.max. 90°C ø 60mm shaft ø 6x4.6mm shaft flat upper black temperature range 30-90°C		
<b>For models:</b>	9ES-122N, 9ES-122NG, 9ES-152N, 9ES-152NG, 9ES-182N, 9ES-182NG		



1

<b>Part No.</b>	110840	<b>Ref. No.</b>	790109380
<b>description</b>	knob switch 7-position ø 60mm shaft ø 6x4.6mm shaft flat upper		





1

<b>Part No.</b>	110851	<b>Ref. No.</b>	760105400
<b>description</b>	knob water ø 60mm shaft ø 6x4.6mm shaft flat upper black		







1

<b>Part No.</b>	112681	<b>Ref. No.</b>	766100000
<b>description</b>	knob gas tap with ignition flame t.max.°C°C ø 60mm shaft ø 10x8mm shaft flat left grey		
<b>accessories for</b>	112681		
	<b>Part No.</b>	110832	<b>Ref. No.</b> 290202430
	knob spring		



1

<b>Part No.</b>	112676	<b>Ref. No.</b>	766100010
<b>description</b>	knob gas tap with ignition flame t.max.°C°C ø 60mm shaft ø 8x6.5mm shaft flat upper grey		
<b>accessories for</b>	112676		
	<b>Part No.</b>	110830	<b>Ref. No.</b> 290202350
	rosette for knob red ID ø 60mm		
	<b>Part No.</b>	110832	<b>Ref. No.</b> 290202430
	knob spring		



1

<b>Part No.</b>	112675	<b>Ref. No.</b>	766100020
<b>description</b>	knob gas tap without ignition flame t.max.°C°C ø 60mm shaft ø 8x6.5mm shaft flat upper grey		



1

<b>Part No.</b>	112883	<b>Ref. No.</b>	766100100
<b>description</b>	knob switch 1-0-1 ø 60mm shaft ø 6x4.6mm shaft flat left grey		

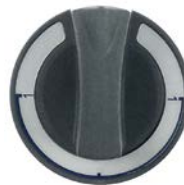

1

<b>Part No.</b>	111794	<b>Ref. No.</b>	766100040
<b>description</b>	knob switch 1-0-1 t.max.°C°C ø 60mm shaft ø 6x4.6mm shaft flat upper grey		



1

<b>Part No.</b>	111478	<b>Ref. No.</b>	766100050
<b>description</b>	knob switch 4-position t.max.°C°C ø 60mm shaft ø 6x4.6mm shaft flat upper grey		

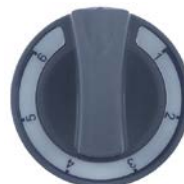

1

<b>Part No.</b>	112679	<b>Ref. No.</b>	766100070
<b>description</b>	knob switch 7-position t.max.°C°C ø 60mm shaft ø 6x4.6mm shaft flat upper grey		



1

<b>Part No.</b>	112872	<b>Ref. No.</b>	766100160
<b>description</b>	knob thermostat t.max. 110°C ø 60mm shaft ø 6x4.6mm shaft flat upper grey		



1

<b>Part No.</b>	112683	<b>Ref. No.</b>	766100120
<b>description</b>	knob thermostat t.max. 180°C 100-180°C ø 60mm shaft ø 6x4.6mm shaft flat upper grey		

1

<b>Part No.</b>	112685	<b>Ref. No.</b>	766100130
<b>description</b>	knob thermostat t.max. 300°C 50-300°C ø 60mm shaft ø 6x4.6mm shaft flat upper grey		



1

<b>Part No.</b>	112776	<b>Ref. No.</b>	766100140
<b>description</b>	knob thermostat t.max. 300°C 50-300°C ø 60mm shaft ø 6x4.6mm shaft flat upper grey		



1

<b>Part No.</b>	112680	<b>Ref. No.</b>	766100110
<b>description</b>	knob thermostat t.max. 90°C 30-90°C ø 60mm shaft ø 6x4.6mm shaft flat upper grey temperature range 30-90°C rotation 270°		



1

<b>Part No.</b>	112873	<b>Ref. No.</b>	770124670
<b>description</b>	knob gas tap with ignition flame ø 70mm shaft ø 8x6mm shaft flat upper grey		



1

<b>Part No.</b>	112779	<b>Ref. No.</b>	770124790
<b>description</b>	knob thermostat t.max. 110°C 30-110°C ø 70mm shaft ø 6x4.6mm shaft flat upper		



1

<b>Part No.</b>	110832	<b>Ref. No.</b>	290202430
<b>description</b>	knob spring		
<b>For models:</b>	110-030A-T, 110-032A-T, 110-037A-T, 110-038A, 110-050A-T, 110-050FE, 110-052A, 110-052FE, 110-052T, 110-057A-T, 110-057FE, 110-058A, 110-122FELC, 110-122FEL-FELR, 110-200A-T, 110-200F, 110-200FE, 110-320AL-ALR, 110-320TL-TLR, 110-322AL-ALC-ALR, 110-322FEL-FELC-FELR, 110-322TL-TLC-TLR, 500-030A-T, 500-038A, 500-039A, 500-050A-T, 500-050FE, 500-125A-126A, 500-320AL-ALCAR, 500-320TL-TLC-TR, 500-322AL-ALC-ALR-AR, 500-322TL-TLC-TLR-TR, 64-020T-64-040T, 64-030T, 64-037T, 64-040FCE, 64-040FE, 64-040F-FV, 64-050FCE, 64-050FE-FEV, 64-050T, 64-057FE, 64-057T, 64-125T-126T, 64-132TL-TLR-TR, 64-222F, 64-222FCE, 64-222FE, 64-222T, 64-320TL-TLC-TR...(Other models you can see in the webshop)		



1

<b>Part No.</b>	110830	<b>Ref. No.</b>	290202350
<b>description</b>	rosette for knob red ID ø 60mm		
<b>For models:</b>	110-030A-T, 110-032A-T, 110-037A-T, 110-038A, 110-050A-T, 110-050FE, 110-052A, 110-052FE, 110-052T, 110-057A-T, 110-057FE, 110-058A, 110-122FELC, 110-122FEL-FELR, 110-200A-T, 110-200F, 110-200FE, 110-320AL-ALR, 110-320TL-TLR, 110-322AL-ALC-ALR, 110-322FEL-FELC-FELR, 110-322TL-TLC-TLR, 110-500A-T, 500-030AT, 500-038A, 500-039A, 500-050A-T, 500-050FE, 500-125A-126A, 500-320AL-ALC-AR, 500-320TL-TLC-TR, 500-322AL-ALC-ALR-AR, 500-322TL-TLC-TLR-TR, 500-500A, 500-701A, 700-020A-C-T, 700-030A-C-T, 700-035A-C-T, 700-037A-T, 700-038A-058A, 700-039A, 700-040A-C-T, 700-040FB, 700-040FEB, 700-050A-C-T, 700-050FEB, 700-052A-C-T, 700-052FEB, 700-054A, 700-054C...(Other models you can see in the webshop)		

steam/water taps

steam/water taps



1

<b>Part No.</b>	110851	<b>Ref. No.</b>	760105400
<b>description</b>	knob water ø 60mm shaft ø 6x4.6mm shaft flat upper black		



## handles and hand wheels

## hand wheels

## hand wheels



1

<b>Part No.</b>	691815	<b>Ref. No.</b>	770307460
-----------------	--------	-----------------	-----------

**description** hand wheel  $\varnothing$  180mm D1  $\varnothing$  40mm bore  $\varnothing$  14mm depth of bore 26mm hole  $\varnothing$  4mm hole distance 5mm L2 156mm with folding handle

**spare parts for** 691815

	<b>Part No.</b>	690856	<b>Ref. No.</b>	—
	folding handle $\varnothing$ 28mm total length 105mm seat $\varnothing$ 21mm shaft $\varnothing$ 8mm thread M6 with shaft and pin L 105mm			



1

<b>Part No.</b>	540742	<b>Ref. No.</b>	790325450
-----------------	--------	-----------------	-----------

**description** hand wheel  $\varnothing$  180mm D1  $\varnothing$  40mm bore  $\varnothing$  17mm depth of bore 26mm hole  $\varnothing$  5mm hole distance 10mm L2 156mm with folding handle

**For models:** 700-900, 700-930, 900-900, 900-930, 900-940, 900-950, 920-900, 920-930, 920-940, 920-950

**spare parts for** 540742

	<b>Part No.</b>	690856	<b>Ref. No.</b>	—
	folding handle $\varnothing$ 28mm total length 105mm seat $\varnothing$ 21mm shaft $\varnothing$ 8mm thread M6 with shaft and pin L 105mm			

## star handles



1

<b>Part No.</b>	540738	<b>Ref. No.</b>	760308790 790305070
-----------------	--------	-----------------	------------------------

**description** star handle thread bore  $\varnothing$  10mm  $\varnothing$  58mm L 38mm black

## hand cranks



1

<b>Part No.</b>	540741	<b>Ref. No.</b>	770307460
-----------------	--------	-----------------	-----------

**description** hand crank bore  $\varnothing$  14mm L 80mm with folding handle



1

<b>Part No.</b>	540743	<b>Ref. No.</b>	790107790
-----------------	--------	-----------------	-----------

**description** hand crank for frying pan

**For models:** 700-622, 700-632, 900-622, 900-632, 900-642, 900-652, 920-622, 920-632, 920-642, 920-652

## locks

## edgmount latches

## push button latches

## RAHRBACH

## 6186 PRESTO series

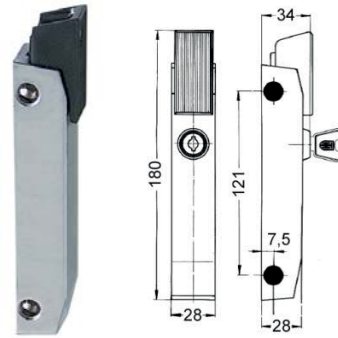

1

<b>Part No.</b>	700045	<b>Ref. No.</b>	419506186
-----------------	--------	-----------------	-----------

**description** push button latch L 180mm mounting distance 121mm non lockable refrigeration units 6186 H 34mm W 28mm type PRESTO

**spare parts for** 700045

	<b>Part No.</b>	700046	<b>Ref. No.</b>	—
	handle H 26.5mm L 55mm W 23.5mm plastic with spring spring length 14mm mounting thread M4 spring thickness 0.5mm			

**accessories for** 700045

	<b>Part No.</b>	690108	<b>Ref. No.</b>	—
	base plate H 5mm L 47.5mm W 21mm for swinging strike hole distance 31mm type PRESTO no. 6186			

	<b>Part No.</b>	690109	<b>Ref. No.</b>	—
	base plate H 1mm L 47.5mm W 21mm plastic hole distance 31mm type PRESTO no. 6186			

	<b>Part No.</b>	700050	<b>Ref. No.</b>	—
	door catch H 5mm L 47mm W 21mm hole distance 31mm with spigot refrigeration units type PRESTO no. 6186			

	<b>Part No.</b>	700051	<b>Ref. No.</b>	—
	door catch H 5mm L 48mm W 21mm adjustable hole distance 31mm with spigot type PRESTO no. 6186			



handle latches



<b>Part No.</b>	700045	<b>Ref. No.</b>	419506186
<b>description</b>	push button latch L 180mm mounting distance 121mm non lockable refrigeration units 6186 H 34mm W 28mm type PRESTO		
<b>spare parts for</b>	700045		
	<b>Part No.</b>	700046	<b>Ref. No.</b> —
	handle H 26.5mm L 55mm W 23.5mm plastic with spring spring length 14mm mounting thread M4 spring thickness 0.5mm		
<b>accessories for</b>	700045		
	<b>Part No.</b>	690108	<b>Ref. No.</b> —
	base plate H 5mm L 47.5mm W 21mm for swinging strike hole distance 31mm type PRESTO no. 6186		
	<b>Part No.</b>	690109	<b>Ref. No.</b> —
	base plate H 1mm L 47.5mm W 21mm plastic hole distance 31mm type PRESTO no. 6186		
	<b>Part No.</b>	700050	<b>Ref. No.</b> —
	door catch H 5mm L 47mm W 21mm hole distance 31mm with spigot refrigeration units type PRESTO no. 6186		
	<b>Part No.</b>	700051	<b>Ref. No.</b> —
	door catch H 5mm L 48mm W 21mm adjustable hole distance 31mm with spigot type PRESTO no. 6186		

hinges

oven hinges

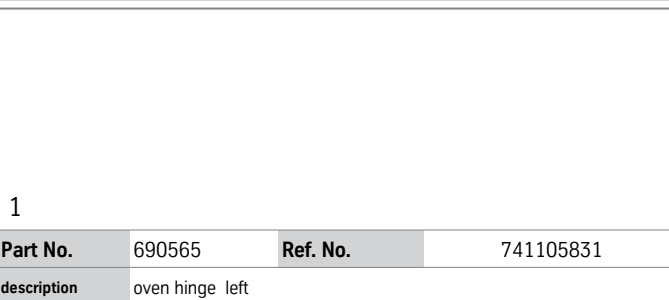

<b>Part No.</b>	690565	<b>Ref. No.</b>	741105831
<b>description</b>	oven hinge left		

<b>Part No.</b>	690564	<b>Ref. No.</b>	741105741
<b>description</b>	oven hinge right		



<b>Part No.</b>	690560	<b>Ref. No.</b>	A00006
<b>description</b>	oven hinge right/left		
<b>For models:</b>	110-050FE, 110-052FE, 110-057FE, 110-122FELC, 110-122FEL-FELR, 110-122FLC, 110-122FL-FLR, 110-200F, 110-200FE, 110-322FEL-FELCFELR, 500-050FE, 64-050FE-FEV, 64-057FE, 64-222FE, 700-040FB, 700-040FEB, 700-050FEB, 700-052FEB, 700-054FEB, 700-055FEB, 700-057FEB, 700-138FBA, 700-138FEBA, 700-162FBA, 700-162FEBA, 700-162FG, 700-200FB, 700-200FEB, 700-222FB, 700-222FEB, 700-224FBA, 700-224FEBA, 700-224FG, 700-411B, 900-040F, 900-040FE, 900-050FE, 900-052FE, 900-054FE, 900-057FE, 900-138FA, 900-138FEA, 900-162FA, 900-162FEA, 900-162FG, 900-172FEA, 900-200F, 900-200FE, 900-411-413, 920-050FE...(Other models you can see in the webshop)		



<b>Part No.</b>	700995	<b>Ref. No.</b>	241201850
<b>description</b>	spring L 170mm ø 18mm wire gauge ø 3.5mm for oven hinge		

fittings for catering equipment

outlet taps

producer-specific

GICO



<b>Part No.</b>	540746	<b>Ref. No.</b>	760103840
<b>description</b>	adapter for outlet		
<b>For models:</b>	64-600T-603T		





<b>Part No.</b>	514130	<b>Ref. No.</b>	333302006
<b>description</b>	ball handle thread M6 IT		
<b>For models:</b>	64-500T, 64-542T, 700-400A-C-T, 700-402A-C-T, 700-500A-C-T, 700-542A-C-T		







			
1			
<b>Part No.</b>	540730	<b>Ref. No.</b>	433207
<b>description</b>	ball valve connection 3/4" IT - 3/4" IT DN20 total length 70mm with lever handle handle length 95mm		
<b>For models:</b>	500-750A, 500-755A, 500-800A, 700-750A-S, 700-755A-S, 700-800A-S, 700-855A-S, 900-750A-S, 900-755A-S, 900-800A-S, 900-855A-S, 920-750A-S, 920-755A-S		

			
1			
<b>Part No.</b>	540734	<b>Ref. No.</b>	760302430
<b>description</b>	drain pipe thread		
<b>For models:</b>	64-600T-603T, 64-700T, 64-703T, 700-400A-C-T, 700-402A-C-T		

			
1			
<b>Part No.</b>	540735	<b>Ref. No.</b>	760103020
<b>description</b>	lever for outlet tap		

			
1			
<b>Part No.</b>	520506	<b>Ref. No.</b>	A00450
<b>description</b>	outlet tap connection 1" IT complete with shaft and lever handle length 70mm H 89mm L 115mm W 47mm shaft L 170mm for fryer IT 1" lever handle spout ø 26mm		
<b>For models:</b>	700-601A-S, 700-602A-S, 700-604A-605A, 700-609A, 700-701A-S, 700-702A-S, 900-601A-S, 900-602A-S, 900-604A-S, 900-605A-S, 900-701A-S, 900-702A-S, 920-604A-S		

### aerators and air bleeders

			
1			
<b>Part No.</b>	540824	<b>Ref. No.</b>	42233014
<b>description</b>	pressure compensation valve thread 1/4" ET WS 19 chrome-plated L 18mm		
<b>For models:</b>	900-503, 900-506, 900-523, 900-526, 920-503, 920-506, 920-523, 920-526		

### lid hinges

#### miscellaneous

#### lid hinges

			
1			
<b>Part No.</b>	700034	<b>Ref. No.</b>	A00421
<b>description</b>	lid hinge flange radius 220mm type 700 series for circular lids		
<b>For models:</b>	700-508, 700-528		

			
1			
<b>Part No.</b>	700035	<b>Ref. No.</b>	A00415
<b>description</b>	lid hinge flange radius 320mm type 900,920 series for circular lids		
<b>For models:</b>	900-503, 900-506, 900-521-522, 900-523, 900-526, 920-503, 920-506, 920-523, 920-526		

### drain taps

#### brass

#### drain taps

			
1			
<b>Part No.</b>	548001	<b>Ref. No.</b>	422116
<b>description</b>	drain tap 1 1/2" IT O-ring seal kettle connection with union nut A 80mm B1 68mm B2 132mm		
<b>For models:</b>	700-508, 700-528		
<b>spare parts for</b>	548001		
	<b>Part No.</b>	505092	<b>Ref. No.</b> —
	O-ring EPDM thickness 5.34mm ID ø 43.82mm Qty 1 pcs		
	<b>Part No.</b>	540213	<b>Ref. No.</b> —
	handle ID ø 5mm L 117mm		



safety fittings

accessories



1			
<b>Part No.</b>	540860	<b>Ref. No.</b>	4227034
<b>description</b>	fitting support thread 3/4" ET suitable for manometer		
<b>For models:</b>	700-508, 700-528		

safety valves



1			
<b>Part No.</b>	540721	<b>Ref. No.</b>	42230020
<b>description</b>	safety valve triggering pressure 0.5bar M88 thread 1 1/4"		
<b>For models:</b>	900-503, 900-506, 900-523, 900-526, 920-503, 920-506, 920-523, 920-526		

accessories for 540721



<b>Part No.</b>	541501	<b>Ref. No.</b>	—
<b>description</b>	reducer for safety fitting IT 1 1/4" ET 3/4"		

baskets

fryer baskets

GICO



1			
<b>Part No.</b>	970641	<b>Ref. No.</b>	270202130
<b>description</b>	fryer basket L1 300mm W1 103mm H1 100mm L2 515mm H2 210mm H3 245mm		



1			
<b>Part No.</b>	970604	<b>Ref. No.</b>	270203840
<b>description</b>	fryer basket L1 365mm W1 115mm H1 100mm L2 575mm H2 150mm H3 200mm chrome-plated steel		



1			
<b>Part No.</b>	970731	<b>Ref. No.</b>	290201220
<b>description</b>	fryer basket W1 128mm L1 400mm H1 102mm		



1			
<b>Part No.</b>	970732	<b>Ref. No.</b>	270202100 270204830
<b>description</b>	fryer basket W1 210mm L1 310mm H1 120mm L2 520mm H2 190mm H3 260mm chrome-plated steel		



1			
<b>Part No.</b>	970730	<b>Ref. No.</b>	270203850
<b>description</b>	fryer basket W1 230mm L1 365mm H1 102mm		

pasta baskets

GICO



1			
<b>Part No.</b>	970000	<b>Ref. No.</b>	264200240
<b>description</b>	pasta basket L1 150mm W1 110mm H1 176mm H2 285mm SS		



1

<b>Part No.</b>	970003	<b>Ref. No.</b>	264200230
<b>description</b>	pasta basket L1 300mm W1 112mm H1 176mm H3 270mm SS		

<b>accessories for</b>	970123		
	<b>Part No.</b>	694701	<b>Ref. No.</b> —
	shelf support L 31/28mm W 22mm H 17mm SS with hook Qty 12 pcs		



## shelves and shelf rails

### grates

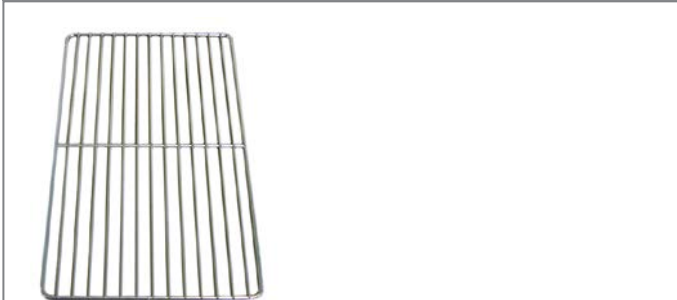

#### universal

#### without upstand

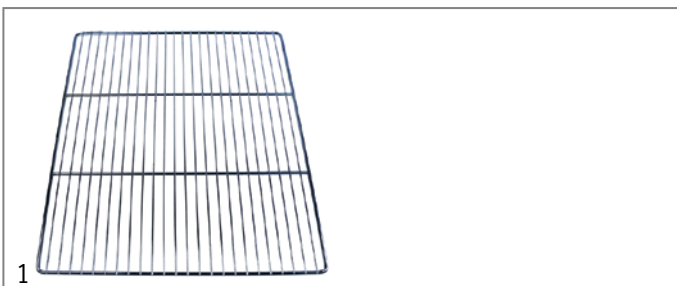

<b>Part No.</b>	970120	<b>Ref. No.</b>	793108350
<b>description</b>	grate W 325mm D 530mm GN 1/1 chrome-plated steel wire gauge frame 7mm lengthwise wires gauge 4mm crossing wires 1		
<b>accessories for</b>	970120		
	<b>Part No.</b>	690330	<b>Ref. No.</b> —
	rack L 1000mm W 22mm H 4mm aperture 3x8mm hole distance 12.5mm stainless steel		
	<b>Part No.</b>	694700	<b>Ref. No.</b> —
	shelf support L 31/28mm W 22mm H 18mm SS Qty 12 pcs		
	<b>Part No.</b>	694701	<b>Ref. No.</b> —
	shelf support L 31/28mm W 22mm H 17mm SS with hook Qty 12 pcs		



<b>Part No.</b>	970123	<b>Ref. No.</b>	241200292
<b>description</b>	grate W 650mm D 530mm GN 2/1 stainless steel wire gauge frame 7.8mm lengthwise wires gauge 3.8mm crossing wires 2 suitable for refrigerator		
<b>accessories for</b>	970123		
	<b>Part No.</b>	690330	<b>Ref. No.</b> —
	rack L 1000mm W 22mm H 4mm aperture 3x8mm hole distance 12.5mm stainless steel		
	<b>Part No.</b>	694700	<b>Ref. No.</b> —
	shelf support L 31/28mm W 22mm H 18mm SS Qty 12 pcs		

## gaskets

### refrigeration gaskets

#### plug-in gaskets

#### profile 9048

We offer custom-made gaskets for this profile

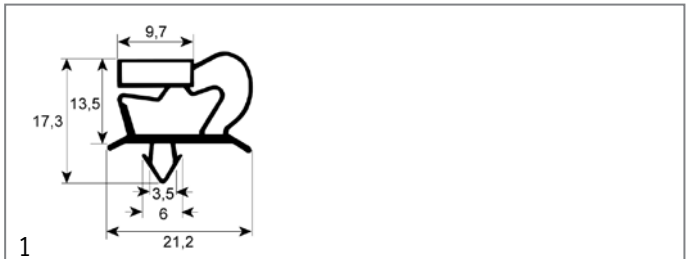

<b>Part No.</b>	901412	<b>Ref. No.</b>	239201360
<b>description</b>	refrigeration gasket profile 9048 W 375mm L 375mm plug size		
<b>For models:</b>	BF70120, BF70160, ES123N, ES124N, ES153N, ES154N, ES183N, ES184N		

### gaskets for heated units

#### window seals



<b>Part No.</b>	900172	<b>Ref. No.</b>	293200610
<b>description</b>	window gasket profile 1540 Qty supplied by meter		

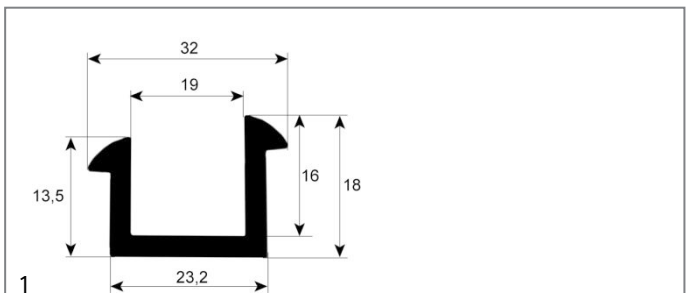

<b>Part No.</b>	900173	<b>Ref. No.</b>	293200620 293203080
<b>description</b>	window gasket profile 1900 L 2400mm Qty 1		



door seals

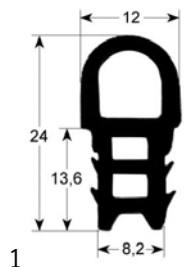

<b>Part No.</b>	900171	<b>Ref. No.</b>	284204130
<b>description</b>	door seal profile 2050 external size Qty supplied by meter		

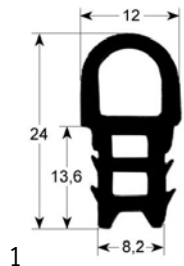

<b>Part No.</b>	901428	<b>Ref. No.</b>	293201230
<b>description</b>	door seal profile 2050 L 1850mm		

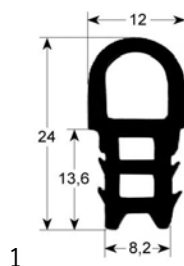

<b>Part No.</b>	901316	<b>Ref. No.</b>	284201430 284201490 293200500 293201400 684201490
<b>description</b>	door seal profile 2050 L 3010mm Qty 1 suitable for GICO		

sealing cords

square



<b>Part No.</b>	601098	<b>Ref. No.</b>	793303880
<b>description</b>	sealing cord square size 6x6mm braided L 0.2m Qty 1		

springs

torsion springs



<b>Part No.</b>	700066	<b>Ref. No.</b>	270203340
<b>description</b>	torsion spring $\varnothing$ 31.1mm L2 140mm wire gauge $\varnothing$ 3.6mm L1 27mm		
<b>For models:</b>	700-508, 700-528		



<b>Part No.</b>	700068	<b>Ref. No.</b>	241200840
<b>description</b>	torsion spring $\varnothing$ 33.2mm L2 135mm wire gauge $\varnothing$ 5.2mm L1 31mm		
<b>For models:</b>	900-503, 900-506, 900-521-522, 900-523, 900-526, 920-503, 920-506, 920-523, 920-526		

compression springs



<b>Part No.</b>	540736	<b>Ref. No.</b>	260201950
<b>description</b>	compression spring $\varnothing$ 20mm L 23mm wire gauge $\varnothing$ 1.3mm		



<b>Part No.</b>	100767	<b>Ref. No.</b>	270200710
<b>description</b>	compression spring $\varnothing$ 9mm L 18mm		



<b>Part No.</b>	700995	<b>Ref. No.</b>	241201850
<b>description</b>	spring L 170mm $\varnothing$ 18mm wire gauge $\varnothing$ 3.5mm for oven hinge		

tension springs



<b>Part No.</b>	700169	<b>Ref. No.</b>	290203700
<b>description</b>	tension spring $\varnothing$ 35mm total length 360mm wire gauge $\varnothing$ 5.3mm		
<b>For models:</b>	900-622, 900-642, 900-900, 900-940, 920-622, 920-642, 920-900, 920-940		



<b>Part No.</b>	700168	<b>Ref. No.</b>	290202420
<b>description</b>	tension spring $\varnothing$ 35mm total length 555mm wire gauge $\varnothing$ 5.1mm		



## valves and tank inlets

## ball valves

## universal

## ball valves with lever handle



<b>Part No.</b>	514325	<b>Ref. No.</b>	4332010
<b>description</b>	ball valve connection 1" IT - 1" IT DN25 total length 83mm with lever handle		
<b>For models:</b>	700-603A, 700-609A, 900-609A, 920-609A		



<b>Part No.</b>	520280	<b>Ref. No.</b>	422312012
<b>description</b>	ball valve connection 1/2" IT - 1/2" IT DN15 total length 50mm with lever handle handle length 85mm		



<b>Part No.</b>	540730	<b>Ref. No.</b>	433207
<b>description</b>	ball valve connection 3/4" IT - 3/4" IT DN20 total length 70mm with lever handle handle length 95mm		
<b>For models:</b>	500-750A, 500-755A, 500-800A, 700-750A-S, 700-755A-S, 700-800A-S, 700-855A-S, 900-750A-S, 900-755A-S, 900-800A-S, 900-855A-S, 920-750A-S, 920-755A-S		

## producer-specific

## GICO



<b>Part No.</b>	520505	<b>Ref. No.</b>	A00465
<b>description</b>	ball valve ET 3/8" for pasta cooker shaft ø 10x8mm		
<b>For models:</b>	700-750A-S, 700-755A-S, 700-800A-S, 700-855A-S, 900-750A-S, 900-755A-S, 900-800A-S, 900-855A-S, 920-750A-S, 920-755A-S		



<b>Part No.</b>	540733	<b>Ref. No.</b>	433206
<b>description</b>	ball valve inlet 1/2" ET outlet 1/2" ET L 74mm without handle shaft ø 10x7mm for pipe ø 14mm		
<b>For models:</b>	500-125A-126A, 500-750A, 500-755A, 500-800A, 64-500T, 64-542T, 64-600T-603T, 64-700T, 64-703T, 64-755T, 700-125A-C, 700-125T, 700-126A-C, 700-126T, 700-127A-C, 700-127T, 700-325A-326A, 700-400A-C-T, 700-402A-C-T, 700-500A-C-T, 700-542A-C-T, 900-125A-C, 900-125T, 900-126A-C, 900-126T, 900-127A-C, 900-127T, 900-325A-326A		



<b>Part No.</b>	520506	<b>Ref. No.</b>	A00450
<b>description</b>	outlet tap connection 1" IT complete with shaft and lever handle length 70mm H 89mm L 115mm W 47mm shaft L 170mm for fryer IT 1" lever handle spout ø 26mm		
<b>For models:</b>	700-601A-S, 700-602A-S, 700-604A-605A, 700-609A, 700-701A-S, 700-702A-S, 900-601A-S, 900-602A-S, 900-604A-S, 900-605A-S, 900-701A-S, 900-702A-S, 920-604A-S		

## ball valves electric



<b>Part No.</b>	403026 <sup>1</sup>	<b>Ref. No.</b>	6441001 6441002
<b>description</b>	ball valve inlet 1/2" IT outlet 1/2" IT 230V L 90mm 50/60Hz off-current open mode of operation electric W 60mm H 100mm connection cable 450mm IT 1/2"		

<sup>1</sup>off-current open







shut-off valves

producer-specific



GICO



<b>Part No.</b>	540737	<b>Ref. No.</b>	790304640
<b>description</b>	shut-off valve connection 1/2" 1/2" straight total length 52mm mounting pos. rosette thread G2 26x19G shaft $\emptyset$ M5x0.8mm		
<b>accessories for</b>	540737		
	<b>Part No.</b>	514085	<b>Ref. No.</b> —
	rosette connection 26x19G chrome-plated total lengthmm mounting pos.		
	<b>Part No.</b>	514086	<b>Ref. No.</b> —
	hexagonal nut connection 26x19G brass total lengthmm mounting pos. H 6mm WS 34 Qty 1 pcs		
	<b>Part No.</b>	540738	<b>Ref. No.</b> 760308790 790305070
	star handle thread bore $\emptyset$ 10mm $\emptyset$ 58mm L 38mm black		



<b>Part No.</b>	540738	<b>Ref. No.</b>	760308790 790305070
<b>description</b>	star handle thread bore $\emptyset$ 10mm $\emptyset$ 58mm L 38mm black		

<b>accessories for</b>	542005		
	<b>Part No.</b>	511474	<b>Ref. No.</b> —
	flat washer for thread 1/2"		
	<b>Part No.</b>	511477	<b>Ref. No.</b> —
	flat gasket rubber ED $\emptyset$ 42mm ID $\emptyset$ 21mm thickness 2mm Qty 1 pcs		



<b>Part No.</b>	540740	<b>Ref. No.</b>	760105750
<b>description</b>	inlet spout		

accessories

miscellaneous



<b>Part No.</b>	694345	<b>Ref. No.</b>	750309770
<b>description</b>	coupling for water valve int. $\emptyset$ 1 10mm int. $\emptyset$ 2 22mm ED $\emptyset$ 20/28mm L 34mm WS 24 thread M5		

inlet taps

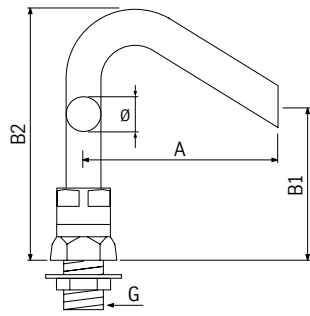

<b>Part No.</b>	542005	<b>Ref. No.</b>	A00086
<b>description</b>	inlet spout connection 1/2" ET tube $\emptyset$ 18mm projection 105mm overall height 130mm spout height 70mm rotation 360°		
<b>For models:</b>	500-750A, 500-755A, 500-800A, 700-508, 700-528, 700-750A-S, 700-755A-S, 700-800A-S, 700-855A-S, 900-503, 900-506, 900-521-522, 900-523, 900-526, 900-750A-S, 900-755A-S, 900-800A-S, 900-855A-S, 920-503, 920-506, 920-523, 920-526, 920-750A-S, 920-755A-S		
<b>accessories for</b>	542005		
	<b>Part No.</b>	511470	<b>Ref. No.</b> —
	nut thread 1/2" $\emptyset$ 40mm H 8mm WS 25 brass Qty 1 pcs		

drain systems and wash basins

drain fittings

producer-specific



<b>Part No.</b>	515117	<b>Ref. No.</b>	423301 739308000
<b>description</b>	drain fitting thread 3/4" ID $\emptyset$ 20mm ED $\emptyset$ 32mm		



## standpipes

producer-specific

GICO



1

<b>Part No.</b>	515116	<b>Ref. No.</b>	270122320
<b>description</b>	drain fitting thread M36x2 H 20mm ID ø 30mm complete with over-flow pipe ED ø 45mm WS 41		

## accessories



1

<b>Part No.</b>	697894	<b>Ref. No.</b>	790330660
<b>description</b>	drain pipe thread 3/4 L 100mm ø 26.6mm		

## measuring equipment

thermometers

built-in thermometers

ø52mm



1

<b>Part No.</b>	541077	<b>Ref. No.</b>	4251103552
<b>description</b>	thermometer mounting ø 52mm t.max. 350°C +50 up to +350°C probe ø 6mm probe L 30mm capillary pipe 1000mm built-in depth 28mm		

**GASTRO**PARTS.COM

