



GASTROPARTS

Gastrofrit

- [EN]** Equipment
- [DE]** Geräte
- [ES]** Aparatos
- [FR]** Équipement
- [IT]** Attrezzature
- [PL]** Urządzenia
- [RU]** Оборудование

✉ gastroparts@gastroparts.com

☎ +48 56 657 00 66

📘 fb.com/gastroparts.global

GASTROPARTS.COM





heating elements

heating elements for fryers

1

Part No.	418532	Ref. No.	306010.024
description	heating element 6900W 230/400V heating circuits 3 L 350mm W 215mm H 242mm L1 18mm L2 332mm H1 210mm H2 32mm flange length 250mm flange width 30mm hole distance 85mm hole \varnothing 6mm connection cable cable length 320mm rectangular flange fryer		

1

Part No.	418549	Ref. No.	306010.014
description	heating element 10000W 400V heating circuits 3 L 345mm W 200mm H 275mm windings 15 H1 235mm H2 40mm fryer heaters connection cable		

1

Part No.	418552	Ref. No.	306010.013
description	heating element 10000W 400V heating circuits 3 L 345mm W 206mm H 265mm windings 15 H1 204mm H2 40mm fryer heaters cable length 1000mm tube \varnothing 8.5mm connection length 430mm		

1

Part No.	418550	Ref. No.	306010.017
description	heating element 14000W 400V heating circuits 3 L 349mm W 342mm H 275mm windings 18 H1 242mm H2 33mm fryer heaters tube \varnothing 8.5mm special fixing connection special		

1

Part No.	418551	Ref. No.	306010.010
description	heating element 7200W 400V heating circuits 3 L 285mm W 145mm H 268mm windings 12 H1 238mm H2 30mm fryer heaters cable length 1200mm		

1

Part No.	418572	Ref. No.	306010.041
description	heating element 10000W 400V heating circuits 3 L 335mm W 204mm H 30mm windings 12 fryer heaters tube \varnothing 8mm		

1

Part No.	418573	Ref. No.	306010.042
description	heating element 13500W 400V heating circuits 3 L 343mm W 335mm H 33mm windings 18 fryer heaters tube \varnothing 8mm connection length 13mm		

1

Part No.	418553	Ref. No.	306010.040
description	heating element 7200W 400V heating circuits 3 L 260mm W 155mm H 33mm windings 12 special fixing connection special fryer heaters tube \varnothing 8mm		

1 electric components



accessories

miscellaneous



1

Part No.	418533	Ref. No.	306035.032
-----------------	--------	-----------------	------------

description	connecting block for heating element
--------------------	--------------------------------------



1

Part No.	551106	Ref. No.	306015.006
-----------------	--------	-----------------	------------

description	connecting block for heating element
--------------------	--------------------------------------



1

Part No.	551091	Ref. No.	505000.000
-----------------	--------	-----------------	------------

description	plug-in connection 5-pole with cable for heating element
--------------------	--

thermostats

control and safety thermostats

EGO

control thermostats

55.34_ series



1

Part No.	375143	Ref. No.	306025.007
-----------------	--------	-----------------	------------

description	thermostat t.max. 110°C temperature range 32-110°C 3-pole 3NO 16A probe ø 6mm probe L 138mm capillary pipe 1480mm capillary pipe isolated 1100mm gland nut M9x1 shaft ø 6x4.6mm shaft L 23mm shaft position upper rotation 270°
--------------------	---



1

Part No.	375821	Ref. No.	306025.001 306025.006
-----------------	--------	-----------------	--------------------------

description	thermostat t.max. 190°C temperature range 100-190°C 3-pole 3NO 16A probe ø 6mm probe L 133mm capillary pipe 530mm capillary pipe isolated 500mm gland nut shaft ø 6x4.6mm shaft L 23mm shaft position upper rotation 270° special fixing
--------------------	--

safety thermostats

55.32_ series

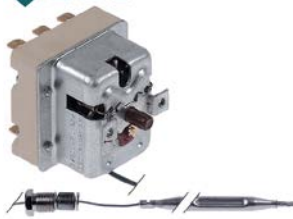

1

Part No.	375393	Ref. No.	306025.010
-----------------	--------	-----------------	------------

description	safety thermostat switch-off temp. 235°C 3-pole 1CO/2NC 20A probe ø 6mm probe L 87mm capillary pipe 1790mm capillary pipe isolated 1710mm gland nut M9x1 probe SS
--------------------	---

55.33_ series



1

Part No.	375746	Ref. No.	306025.005
-----------------	--------	-----------------	------------

description	safety thermostat switch-off temp. 230°C 3-pole 20A probe ø 6mm probe L 117mm capillary pipe 1470mm capillary pipe isolated 1100mm gland nut M9x1 probe SS
--------------------	--





1

Part No.	375995	Ref. No.	306050.010
description	safety thermostat switch-off temp. 230°C 3-pole 3NC 20A probe ø 6mm probe L 103mm capillary pipe 1170mm capillary pipe isolated 1060mm gland nut starting temperature 216°C probe		

switches and momentary switches

microswitches

lever actuated



1

Part No.	347622	Ref. No.	306040.045
description	microswitch with lever 250V 12A 1CO connection male faston 6.3mm L 51mm ambient temperature max. 85°C mounting distance 22.2mm type XGK2-88-J26Z1 actuating force: 40g		



1

Part No.	345791	Ref. No.	306040.045
description	microswitch with lever 250V 12A 1CO connection male faston L 51mm ambient temperature max. 85°C		

cam switches

operation switches



1

Part No.	301214	Ref. No.	306040.030
description	cam switch 2 operating positions operation switch 16A sequence 0-1 shaft ø 6x4.6mm shaft L 33mm connection male faston 6.3mm plastic ambient temperature max. 150°C		

miscellaneous



1

Part No.	346853	Ref. No.	306040.040
description	safety switch heating element with cable		

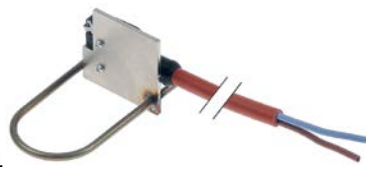

1

Part No.	347626	Ref. No.	505000.106
description	safety switch heating element with cable 1160mm		

control equipment

GEV special

ø22mm

switches (complete)





1



Part No.	347602	Ref. No.	306040.009
description	momentary push switch mounting measurements ø22mm 2NO/2NC 660V max. 16(4)A 0-1 momentary green illuminated connection screw		









1

Part No.	346858	Ref. No.	306040.016	
description	push switch mounting measurements ø22mm 1NO 660V max. 16(4) A 0-1 latching ON-OFF green illuminated connection screw			
spare parts for	346858			
	Part No.	345261	Ref. No.	—
	contact block 2NO 660V max. 16(4)A connection screw			
	Part No.	359252	Ref. No.	—
	light bulb socket Ba9s 230V			



			
1			
Part No.	346857	Ref. No.	306040.013 306040.014
description	push switch mounting measurements ø22mm 1NO 660V max. 16(4) A 0-1 latching red illuminated connection screw		
spare parts for	346857		
	Part No.	345261	Ref. No. —
	contact block 2NO 660V max. 16(4)A connection screw		
	Part No.	359606	Ref. No. —
	neon light bulb socket Ba9s 220V 2W clear ø 10mm L 28mm		

			
1			
Part No.	346856	Ref. No.	306040.008
description	push switch mounting measurements ø22mm 1NO 660V max. 16(4) A 0-1 latching water blue illuminated connection screw		
spare parts for	346856		
	Part No.	345261	Ref. No. —
	contact block 2NO 660V max. 16(4)A connection screw		
	Part No.	359252	Ref. No. —
	light bulb socket Ba9s 230V		

			
1			
Part No.	346855	Ref. No.	306040.014 306040.015
description	push switch mounting measurements ø22mm 3NO/1NC 660V max. 16(4)A 0-1 latching oil pump yellow illuminated connection screw/ F6.3		
spare parts for	346855		
	Part No.	345261	Ref. No. —
	contact block 2NO 660V max. 16(4)A connection screw		
	Part No.	345272	Ref. No. —
	contact block 1NC/1NO 660V max. 16(4)A connection screw		
	Part No.	359606	Ref. No. —
	neon light bulb socket Ba9s 220V 2W clear ø 10mm L 28mm		

			
1			
Part No.	347625	Ref. No.	306040.011
description	push switch mounting measurements ø22mm 3NO/1NC 660V max. 16(4)A 0-1 latching yellow illuminated connection screw		

lamps

indicator lights

indicator lights (complete)

ø10mm

with plug-in socket

			
1			
Part No.	359439	Ref. No.	306045.010
description	indicator light ø 10mm 230V green cable length 220mm		

			
1			
Part No.	359438	Ref. No.	306045.011
description	indicator light ø 10mm 230V red cable length 220mm		

contactors

TELEMECANIQUE (Schneider Electric)

power contactors

			
1			
Part No.	380698	Ref. No.	306020.004
description	power contactor resistive load 20A 230VAC (AC3/400V) 12A/5.5kW main contacts 3NO auxiliary contacts 1NO/1NC connection spring terminal type LCD123P7		

1

Part No.	380700	Ref. No.	306020.003
description	power contactor resistive load 38A 230VAC (AC3/400V) 18.5kW main contacts 1NO auxiliary contacts 1NC type LC1D38P7		



1

Part No.	403878	Ref. No.	505000.205
description	solid state relay CRYDOM 3 phase 50A 530V 4-32 L 125mm W 95mm with heat sink		

ALLEN BRADLEY

power contactors



1

Part No.	380459	Ref. No.	306020.002 306020.003
description	power contactor resistive load 65A 230VAC (AC3/400V) 30A/15kW main contacts 3NO connection screw connection type 100-C30KF00 50/60Hz		

miscellaneous



1

Part No.	402564	Ref. No.	505000.094
description	solid state relay AIKS 3 phase 40A 48-480V 3-32 L 105mm W 75mm screw type ASS02-440DA		

solid state relays

CRYDOM



1

Part No.	403038	Ref. No.	505000.150
description	solid state relay CRYDOM 1 phase 50A 480V 4-32VDC L 57mm W 45mm screw type CWD4850P		



probes

producer-specific probes

probes



1

Part No.	400773	Ref. No.	306025.030
description	temperature probe Pt100 cable PTFE probe -100 up to 450°C cable -40 up to +250°C connection 2-wire thread M10x1.5 probe ø4x20mm cable length 0.5m		
accessories for	400773		
	Part No.	532590	Ref. No. —
	O-ring silicone thickness 2.62mm ID ø 13.95mm Qty 1 pcs		
	Part No.	560197	Ref. No. —
	nut thread M10 H 8mm WS 17 SS DIN/ISO DIN 934 / ISO 4032/8673 Qty 1 pcs		



1

Part No.	403037	Ref. No.	306025.033
description	temperature probe Pt1000 cable PTFE probe -100 up to 450°C cable -40 up to +250°C connection 2-wire thread M10 probe ø4x30mm cable length 1m		



electronics

PCBs



1			
Part No.	403044	Ref. No.	502000.019
description	conversion kit Gastro 6/7 into Gastro 8		



1			
Part No.	400770	Ref. No.	306200.020
description	display PCB		

Triacs

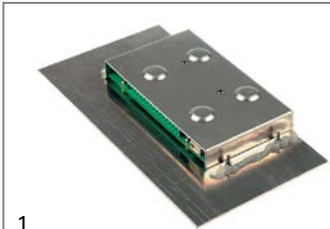

1			
Part No.	400771	Ref. No.	306200.007
description	Triac		

keypads

membrane keypads



1			
Part No.	403036	Ref. No.	306200.013
description	membrane keypad buttons 7 L 150mm W 80mm		

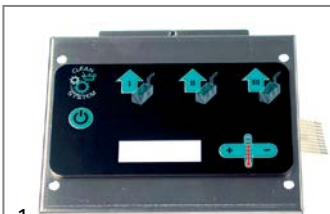

1			
Part No.	400766	Ref. No.	306200.015
description	membrane keypad for fryer		

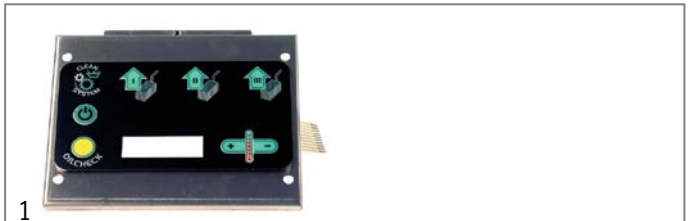

1			
Part No.	400767	Ref. No.	306200.016
description	membrane keypad for fryer		

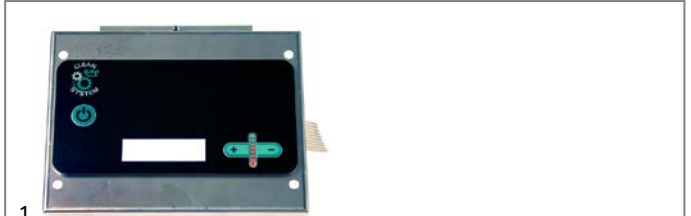

1			
Part No.	400768	Ref. No.	306200.014
description	membrane keypad for fryer		

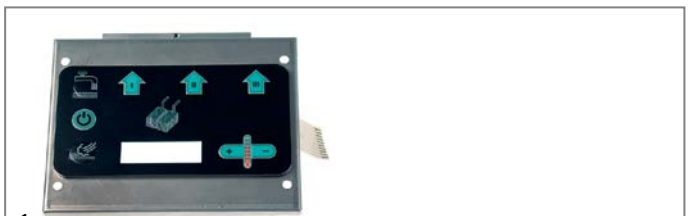

1			
Part No.	400765	Ref. No.	306200.018
description	membrane keypad for pasta cooker		

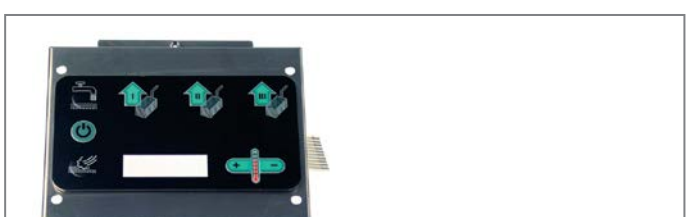

1			
Part No.	400764	Ref. No.	306200.017
description	membrane keypad pasta cooker TW-300		

solenoid valves

solenoid valves (water)

various



1			
Part No.	372215	Ref. No.	309030.001 501000.002 (old version)
description	solenoid valve assembly		



metal

ODE

2-way



1

Part No.	372004	Ref. No.	501000.002
description	solenoid valve assembly brass 2-ways supply 220/230VAC inlet 3/8" ET outlet 3/8" ET L 145mm DN 12mm ODE p max 0.1bar p min 20bar 50/60Hz		

pumps

oil pumps



1

Part No.	500673	Ref. No.	306099.200
description	oil pump BRINKMANN type TB16/170-GZX+581 70W 230V 50Hz L 300mm 960l/h capacitor 5µF		

electric accessories

plugs - couplings - power sockets

protective contact power sockets

producer-specific power sockets

miscellaneous



1

Part No.	551104	Ref. No.	306035.033
description	power socket SEV1011 type 13 built-in version 3-pole contacts P+N+E max. 10A max 250V countries CH		

cables

ribbon cables

group 1



1

Part No.	400772	Ref. No.	306200.006
description	ribbon cable 34-pole L 135mm plug type FC-34P raster size 2.54mm		

terminals

PCB terminal blocks



1

Part No.	403039	Ref. No.	306035.038
description	PCB terminal block 13-pole raster size 5mm		

equipment-specific units

for deep fryers

miscellaneous



1

Part No.	692220	Ref. No.	302050.025
description	lifting device for basket mounting pos. left		



1

Part No.	692221	Ref. No.	302025.024 302050.024
description	lifting device for basket mounting pos. right		



1

Part No.	693942	Ref. No.	306099.015
description	lifting device without limit switch for fryer basket mounting pos. right		

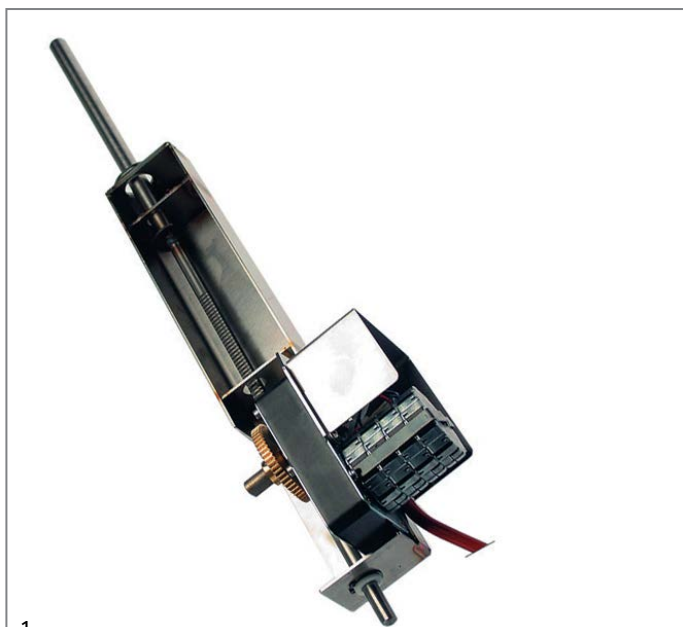

1

Part No.	693941	Ref. No.	306099.010
description	lifting device without limit switch for fryer basket mounting pos. left		



1

Part No.	692222	Ref. No.	303090.010
description	pump hose with pipe		

knobs

universal knobs

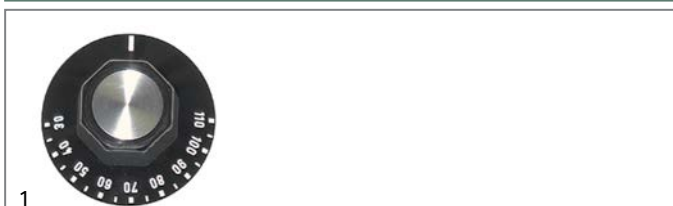

1

Part No.	110119	Ref. No.	306025.004
description	knob thermostat t.max. 110°C ø 50mm shaft ø 6x4.6mm shaft flat upper black temperature range 30-110°C rotation 270°		

accessories for 110119

	Part No.	110135	Ref. No.	—
	rosette knob up to ø 52mm			





1

Part No.	110434	Ref. No.	306025.002
description	knob thermostat t.max. 190°C ø 50mm shaft ø 6x4.6mm shaft flat upper silver temperature range 100-190°C rotation 270°		
accessories for	110434		
	Part No.	110135	Ref. No.
			—
	rosette knob up to ø 52mm		

producer-specific knobs

GASTROFRIT



1

Part No.	110119	Ref. No.	306025.004
description	knob thermostat t.max. 110°C ø 50mm shaft ø 6x4.6mm shaft flat upper black temperature range 30-110°C rotation 270°		
accessories for	110119		
	Part No.	110135	Ref. No.
			—
	rosette knob up to ø 52mm		



1

Part No.	110434	Ref. No.	306025.002
description	knob thermostat t.max. 190°C ø 50mm shaft ø 6x4.6mm shaft flat upper silver temperature range 100-190°C rotation 270°		
accessories for	110434		
	Part No.	110135	Ref. No.
			—
	rosette knob up to ø 52mm		

filters

deep fryer filters



1

Part No.	970544	Ref. No.	305099.002
description	oil filter W 200mm L 260mm Qty 1 pcs for fryer Hmm without handle		



1

Part No.	970543	Ref. No.	305099.003
description	oil filter W 230mm L 475mm Qty 1 pcs for fryer H 30mm metall frame		
accessories for	970543		
	Part No.	970544	Ref. No.
			305099.002
	oil filter W 200mm L 260mm Qty 1 pcs for fryer Hmm without handle		

baskets

fryer baskets

GASTROFRIT



1

Part No.	970881	Ref. No.	503000.366
description	bezel for fryer basket		



1

Part No.	970882	Ref. No.	503000.365
description	bezel for fryer basket		



1 

Part No.	970752	Ref. No.	303010.001
description	fryer basket W1 150mm L1 250mm H1 160mm H2 250mm		
accessories for	970752		
	Part No.	970882	Ref. No. 503000.365
	bezel for fryer basket		

1 

Part No.	970755	Ref. No.	303010.004
description	fryer basket W1 350mm L1 310mm H1 160mm H2 230mm		

1 

Part No.	970751	Ref. No.	303010.002
description	fryer basket W1 215mm L1 300mm H1 160mm H2 250mm		
accessories for	970751		
	Part No.	970881	Ref. No. 503000.366
	bezel for fryer basket		

1 

Part No.	970538	Ref. No.	303010.004
description	fryer basket W1 350mm L1 310mm H1 160mm H2 250mm		

pasta baskets

GASTROFRIT

1 

Part No.	970759	Ref. No.	303010.052
description	fryer basket W1 350mm L1 295mm H1 160mm stainless steel		

1 

Part No.	970756	Ref. No.	301080.073
description	pasta basket H1 155mm W1 105mm L1 155mm size 1/6 left		

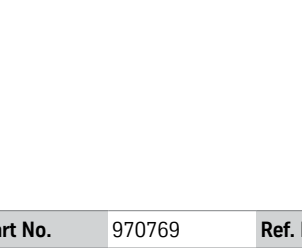
1 

Part No.	970769	Ref. No.	303010.052
description	fryer basket W1 350mm L1 300mm H1 195mm stainless steel with bezel		

1 

Part No.	970757	Ref. No.	301080.076
description	pasta basket H1 155mm W1 105mm L1 155mm size 1/6 right		

1

Part No.	970806	Ref. No.	301080.070
description	pasta basket H1 185mm W1 95mm L1 135mm size 1/6 H2 250mm		



1

Part No.	970754	Ref. No.	303010.053
description	pasta basket H1 195mm W1 200mm L1 300mm L2 530mm H2 250mm with holder		



1

Part No.	970540	Ref. No.	303010.056	
description	pasta basket L1 300mm W1 150mm H1 200mm H3 245mm stainless steel			
accessories for	970540			
	Part No.	970882	Ref. No.	503000.365
	bezel for fryer basket			



1

Part No.	970541	Ref. No.	303010.055
description	pasta basket L1 300mm W1 200mm H1 155mm H3 250mm stainless steel		



1

Part No.	970542	Ref. No.	303010.057	
description	pasta basket L1 300mm W1 345mm H1 200mm H3 245mm stainless steel			
accessories for	970542			
	Part No.	970881	Ref. No.	503000.366
	bezel for fryer basket			



1

Part No.	970760	Ref. No.	303010.058
description	pasta basket W1 150mm L1 300mm H1 195mm stainless steel		



1

Part No.	970758	Ref. No.	301080.069
description	pasta basket W1 90mm L1 135mm H1 185mm size 1/6		

gaskets

O-rings

Viton



Part No.	532622	Ref. No.	503000.030
description	O-ring EPDM thickness 5.7mm ID ø 34mm Qty 1 pcs		

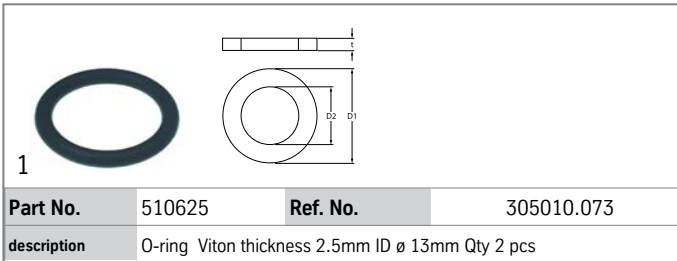

Part No.	510625	Ref. No.	305010.073
description	O-ring Viton thickness 2.5mm ID ø 13mm Qty 2 pcs		

valves and tank inlets

ball valves

universal

ball valves with lever handle

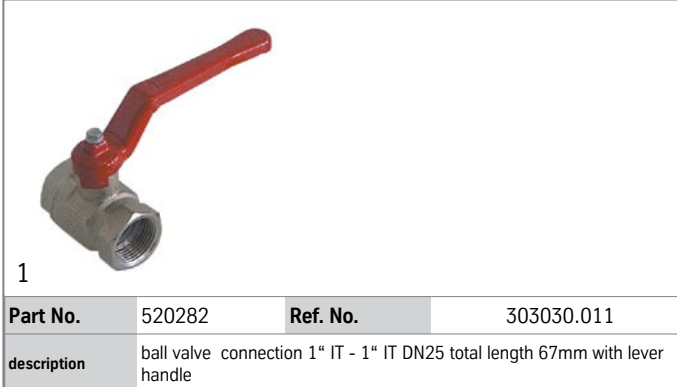

Part No.	520282	Ref. No.	303030.011
description	ball valve connection 1" IT - 1" IT DN25 total length 67mm with lever handle		

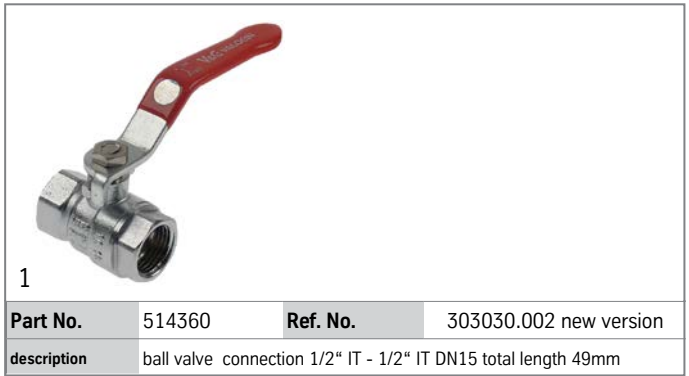

Part No.	514360	Ref. No.	303030.002 new version
description	ball valve connection 1/2" IT - 1/2" IT DN15 total length 49mm		

producer-specific

GASTROFRIT

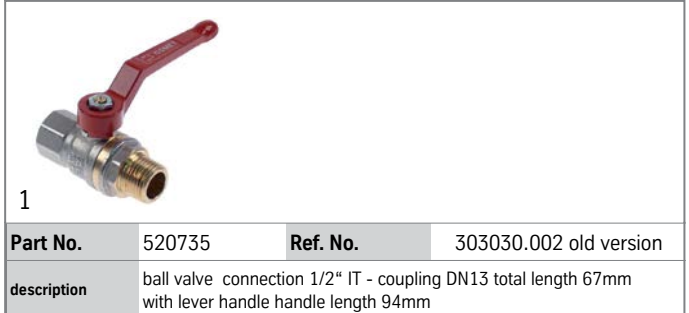

Part No.	520735	Ref. No.	303030.002 old version
description	ball valve connection 1/2" IT - coupling DN13 total length 67mm with lever handle handle length 94mm		