



**GASTROPARTS**

# Gamko

- [EN]** Equipment
- [DE]** Geräte
- [ES]** Aparatos
- [FR]** Équipement
- [IT]** Attrezzature
- [PL]** Urządzenia
- [RU]** Оборудование

✉ [gastroparts@gastroparts.com](mailto:gastroparts@gastroparts.com)

☎ +48 56 657 00 66

📘 [fb.com/gastroparts.global](https://fb.com/gastroparts.global)

**GASTROPARTS.COM**





## switches and momentary switches

### microswitches

with push button

switches with snap-fit



1

<b>Part No.</b>	346772	<b>Ref. No.</b>	008040111
<b>description</b>	microswitch with push button 250V 5A 1CO connection male faston 4.8mm L 24x27mm ambient temperature max. 85°C actuating force: 160g		

## timers

### defrost timers

MINI T



1

<b>Part No.</b>	360150	<b>Ref. No.</b>	008060005
<b>description</b>	switch clock type 3611 defrosting interval 1-48x per 24h defrosting time 15-144 minmin fan delaymin defr. funct. 1-48x per 24h		

## electronic controllers

### DIXELL

refrigeration controllers

built-in version



1

<b>Part No.</b>	378267	<b>Ref. No.</b>	005050168	
<b>description</b>	electronic controller DIXELL XR02CX-5N0C1 mounting measurements 71x29mm built-in depth 56mm 230V voltage AC NTC relay outputs 1 NO-20A(8) NTC DI protection IP54 defrosting function/time control -40 up to +110°C display 2½ digit			
<b>For models:</b>	MG145-McDonalds, MG95-McDonalds			
<b>accessories for</b>	378267			
	<b>Part No.</b>	379161	<b>Ref. No.</b>	—
	temperature probe NTC 10kOhm cable thermoplastic probe -40 up to +110°C cable -40 up to +110°C probe ø6x14mm cable length 3m without screw connection 2-wire			
	<b>Part No.</b>	381249	<b>Ref. No.</b>	—
	temperature probe NTC 10kOhm cable PVC probe -40 up to +110°C cable -10 up to 100°C connection 2-wire thread probe ø6x14mm cable length 3m			

## LAE

refrigeration controllers

built-in version



1

<b>Part No.</b>	378184	<b>Ref. No.</b>	005050225	
<b>description</b>	electronic controller LAE type LCD32Q4E-C mounting measurements 149x30mm 230V voltage AC NTC relay outputs 4 NO-20A(6) NO-12A(4) NO-8A(3) CO-8A(3) NTC NTC DI DI front measurements 169x38mm built-in depth 78mm protection IP55 yes yes -30 up to +30°C display 3 digits			
<b>accessories for</b>	378184			
	<b>Part No.</b>	379784	<b>Ref. No.</b>	—
	temperature probe NTC 2kOhm cable thermoplastic probe -40 up to +110°C cable -40 up to +110°C probe ø6x35mm cable length 2m without screw connection 2-wire resistor 2kOhm			

## evaporation and condensing trays

### condensing trays heated

universal

condensing trays



1

<b>Part No.</b>	750431	<b>Ref. No.</b>	008100029	
<b>description</b>	condensing tray horizontal L 300mm W 140mm H 100mm with howle for heating cartridge PTC (3/8") universal capacity 2.8l			
<b>accessories for</b>	750431			
	<b>Part No.</b>	417570	<b>Ref. No.</b>	—
	heating cartridge 110W 230V ø 12mm L 120mm thread 3/8" cable length 1000mm universal			
	<b>Part No.</b>	417571	<b>Ref. No.</b>	—
	heating cartridge 230W 230V ø 12mm L 180mm thread 3/8" cable length 1000mm universal			
	<b>Part No.</b>	417572	<b>Ref. No.</b>	—
	heating cartridge 330W 230V ø 12mm L 240mm thread 3/8" cable length 1000mm universal			
	<b>Part No.</b>	417577	<b>Ref. No.</b>	—
	heating cartridge 190W 230V ø 12mm L 180mm thread 3/8" cable length 300mm suitable for MONDIAL			



## fans

## axial fans

## import



1

<b>Part No.</b>	601601 <sup>1</sup>	<b>Ref. No.</b>	007030229
<b>description</b>	axial fan L 119mm W 119mm H 38mm 230VAC 50/60Hz 22W bearing slide bearing manuf. no. DP200A2123XST.GN SUNON input current 0.14A		
<b>For models:</b>	MG145-McDonalds, MG95-McDonalds		

<sup>1</sup>with slide bearings

1

<b>Part No.</b>	601457 <sup>1</sup>	<b>Ref. No.</b>	007030260
<b>description</b>	axial fan L 127mm W 127mm H 38mm 12VDC 12.72W bearing ball bearing connection cable 300mm plastic ADDA fan wheel ø 120mm		

<sup>1</sup>with ball bearings

## refrigeration fans

## refrigeration motors universal

## ebm-papst

## multi fit fan motors

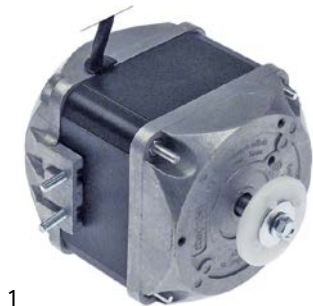

1

<b>Part No.</b>	601760	<b>Ref. No.</b>	007030268
<b>description</b>	fan motor 25W 230V 50/60Hz L1 44mm L3 103mm W 77.5mm cable length 1500mm 1300/1550rpm ebm-papst M4Q045-EA01-75 5 mounting options bearing slide bearing		
<b>spare parts for</b>	601760		
	<b>Part No.</b>	601413	<b>Ref. No.</b> —
	fixing plate suitable for fanwheel ED ø 32mm shaft ø 7 mounting distance 26mm		

## ELCO

## N series - multi fit







1

<b>Part No.</b>	601528	<b>Ref. No.</b>	007030267
<b>description</b>	fan motor ELCO 16W 230V 50/60Hz bearing slide bearing L1 48mm L2 64mm L3 91.5mm W 83mm connection cable 500mm 1300/1550rpm 5 mounting options VNT16-25/029		
<b>spare parts for</b>	601528		
	<b>Part No.</b>	601413	<b>Ref. No.</b> —
	fixing plate suitable for fanwheel ED ø 32mm shaft ø 7 mounting distance 26mm		



1

<b>Part No.</b>	601430	<b>Ref. No.</b>	007030265
<b>description</b>	fan motor ELCO 5W 230V 50/60Hz bearing slide bearing L1 48mm L2 52mm L3 79.5mm W 83mm connection cable 500mm 1300/1550rpm 5 mounting options VNT5-13/027		
<b>spare parts for</b>	601430		
	<b>Part No.</b>	560140	<b>Ref. No.</b> —
	hexagonal nut thread M4 H 4.8mm SS WS 7 Qty 20 pcs DIN/ISO DIN 985 self-locking		
	<b>Part No.</b>	560332	<b>Ref. No.</b> —
	plain washer ID ø 4.3mm ED ø 9mm thickness 0.8mm SS Qty 1 pcs		
	<b>Part No.</b>	560340	<b>Ref. No.</b> —
	hexagonal nut thread M4 H 3.2mm WS 7 SS DIN/ISO DIN 934 / ISO 4032/8673 Qty 1 pcs		
	<b>Part No.</b>	601413	<b>Ref. No.</b> —
	fixing plate suitable for fanwheel ED ø 32mm shaft ø 7 mounting distance 26mm		



FMI



1

<b>Part No.</b>	601331	<b>Ref. No.</b>	007030203
<b>description</b>	fan motor 10W 230V 50Hz L1 58mm L2 51mm L3 88mm W 84mm cable length 500mm 1250rpm AA.7AL.639.X 5 mounting options bearing slide bearing		
<b>spare parts for</b>	601331		
	<b>Part No.</b>	601413	<b>Ref. No.</b> —
	fixing plate suitable for fanwheel ED $\varnothing$ 32mm shaft $\varnothing$ 7 mounting distance 26mm		



1

<b>Part No.</b>	601330	<b>Ref. No.</b>	
<b>description</b>	fan motor 5W 230V 50Hz L1 51mm L2 51mm L3 81mm W 84mm cable length 200mm 1250rpm AA.7AL.639.X 5 mounting options bearing slide bearing		
<b>spare parts for</b>	601330		
	<b>Part No.</b>	601413	<b>Ref. No.</b> —
	fixing plate suitable for fanwheel ED $\varnothing$ 32mm shaft $\varnothing$ 7 mounting distance 26mm		

**motors**

gear motors

for ice-cube maker

miscellaneous



1

<b>Part No.</b>	601445	<b>Ref. No.</b>	025010609
<b>description</b>	gear motor 1rpm		

for gyros grills



1

<b>Part No.</b>	500605	<b>Ref. No.</b>	025010611
<b>description</b>	gear motor CROUZET type 805274 16.7W 230V 50Hz 1rpm shaft $\varnothing$ 7x8mm L 65mm W 65mm H 58mm		

**gaskets**

refrigeration gaskets

plug-in gaskets

profile 9197

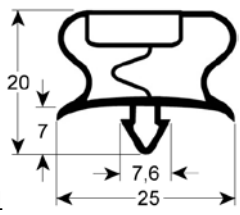

1

<b>Part No.</b>	902568	<b>Ref. No.</b>	006110523
<b>description</b>	refrigeration gasket profile 9197 W 295mm L 399mm plug size		

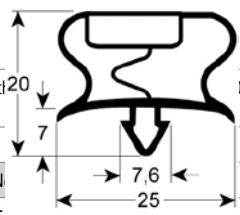

1

<b>Part No.</b>	902567	<b>Ref. No.</b>	006110522
<b>description</b>	refrigeration gasket profile 9197 W 399mm L 627mm plug size		

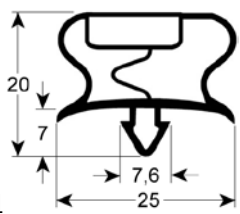

1

<b>Part No.</b>	902566	<b>Ref. No.</b>	006110517
<b>description</b>	refrigeration gasket profile 9197 W 399mm L 670mm plug size		



<b>Part No.</b>	902572	<b>Ref. No.</b>	006110565
<b>description</b>	refrigeration gasket profile 9197 W 485mm L 506mm plug size		

<b>Part No.</b>	902565	<b>Ref. No.</b>	006110512
<b>description</b>	refrigeration gasket profile 9197 W 617mm L 1467mm plug size		

profile 9153

We offer custom-made gaskets for this profile

<b>Part No.</b>	902561	<b>Ref. No.</b>	006110484
<b>description</b>	refrigeration gasket profile 9153 W 224mm L 491mm plug size		

<b>Part No.</b>	902570	<b>Ref. No.</b>	006110537
<b>description</b>	refrigeration gasket profile 9153 W 287mm L 752mm plug size		

<b>Part No.</b>	902563	<b>Ref. No.</b>	006110486
<b>description</b>	refrigeration gasket profile 9153 W 294mm L 491mm plug size		

<b>Part No.</b>	902560	<b>Ref. No.</b>	006110483
<b>description</b>	refrigeration gasket profile 9153 W 356mm L 491mm plug size		

<b>Part No.</b>	902562	<b>Ref. No.</b>	006110485
<b>description</b>	refrigeration gasket profile 9153 W 420mm L 491mm plug size		

<b>Part No.</b>	902558	<b>Ref. No.</b>	006110417
<b>description</b>	refrigeration gasket profile 9153 W 483mm L 738mm plug size		

<b>Part No.</b>	902559	<b>Ref. No.</b>	006110470
<b>description</b>	refrigeration gasket profile 9153 W 491mm L 752mm plug size		

<b>Part No.</b>	902569	<b>Ref. No.</b>	006110536
<b>description</b>	refrigeration gasket profile 9153 W 499mm L 752mm plug size		

<b>Part No.</b>	902564	<b>Ref. No.</b>	006110487
<b>description</b>	refrigeration gasket profile 9153 W 502mm L 707mm plug size		

<b>Part No.</b>	902571	<b>Ref. No.</b>	005110555
<b>description</b>	refrigeration gasket profile 9153 W 527mm L 752mm plug size		



screw-in gaskets

profile 9207

We offer custom-made gaskets for this profile



<b>Part No.</b>	902557	<b>Ref. No.</b>	006110104
<b>description</b>	refrigeration gasket profile 9207 W 494mm L 753mm external size		

refrigeration cycle components

valves

Schrader valves

Schrader valves (complete)



<b>Part No.</b>	750101	<b>Ref. No.</b>	010030216
<b>description</b>	Schrader valve complete connection 1/4" SAE L 130mm		

refrigeration pipes

insulation



<b>Part No.</b>	694746	<b>Ref. No.</b>	006030466
<b>description</b>	insulating hose 10mm (3/8") thickness 9mm Qty 50m ARMAFLEX refrigeration		



<b>Part No.</b>	694747	<b>Ref. No.</b>	006030467
<b>description</b>	insulating hose 12mm (1/2") thickness 9mm Qty 45m ARMAFLEX refrigeration		



<b>Part No.</b>	694748	<b>Ref. No.</b>	006030468
<b>description</b>	insulating hose 16mm (5/8") thickness 9mm Qty 40m ARMAFLEX refrigeration		

**GASTRO**PARTS.COM

