



GASTROPARTS

Gaggia

- [EN]** Equipment
- [DE]** Geräte
- [ES]** Aparatos
- [FR]** Équipement
- [IT]** Attrezzature
- [PL]** Urządzenia
- [RU]** Оборудование

✉ gastroparts@gastroparts.com

☎ +48 56 657 00 66

📘 fb.com/gastroparts.global

GASTROPARTS.COM







heating elements

heating elements for coffee machine



1 			
Part No.	400338	Ref. No.	DM1804/001
description	heating cartridge 80W 240V ø 12.7mm L 55mm connection cable length 60mm		



1 			
Part No.	417121	Ref. No.	N/A
description	heating element 1000W 230V mounting ø 42mm L 406mm heating circuits 1 connection M6 hole distance 55mm hole ø 10mm W 39mm H 40mm immersion heater tube ø 8mm 3 hole flange L1 40mm L2 50mm L3 316mm suitable for ITALCREM, VISACREM		

1 			
Part No.	417123	Ref. No.	N/A
description	heating element 1250W 230V mounting ø 42mm L 580mm heating circuits 1 connection M6 hole distance 56mm hole ø 10mm W 40mm H 43mm immersion heater tube ø 8mm 3 hole flange L1 45mm L2 45mm L3 490mm suitable for ITALCREM, VISACREM H1 8mm H2 35mm		

1 			
Part No.	417151	Ref. No.	N/A
description	heating element 1300W 230V mounting ø 42mm L 350mm heating circuits 1 connection M6x0.9 hole distance 56mm hole ø 9mm W 38mm H 110mm immersion heater tube ø 8.1mm 3 hole flange L1 50mm L2 105mm L3 220mm suitable for VISACREM H1 8mm H2 98mm		



1 			
Part No.	526629	Ref. No.	ES9190.297.00A
description	heating element 1500W 230V heating circuits 1 mounting ø 40mm hole distance 51mm L 125mm W 35mm H 31mm hole ø 9mm length thermostat sleeves 120mm thermostat sleeves ø 6mm number of thermostat sleeves 1 thermostat sleeve eccentric, clinging/not clinging tube ø 8mm connection male faston 6.3mm immersion heater copper		

1 			
Part No.	417120	Ref. No.	N/A
description	heating element 1500W 230V heating circuits 1 mounting ø 42mm hole distance 56mm L 190mm W 20mm H 40mm hole ø 9mm connection M6x1 immersion heater 3 hole flange suitable for ITALCREM, VISACREM		
accessories for	417120		
	Part No.	528008	Ref. No. N/A
	gasket ID ø 30mm fibre thickness 3mm hole ø 9mm hole distance 44mm for heating element coffee machine parts		

1 			
Part No.	417057	Ref. No.	N/A
description	heating element 1500W 230V heating circuits 2 thread 1¼" L 145mm W 23mm H 37mm tube ø 8mm connection M4 immersion heater flange with thread		
accessories for	417057		
	Part No.	510405	Ref. No. —
	flat gasket fibre ED ø 56mm ID ø 42mm thickness 2mm for thread 1¼" Qty 1 pcs		
	Part No.	528021	Ref. No. —
	flat gasket PTFE ED ø 53mm ID ø 42.5mm thickness 3mm Qty 1 pcs equiv. no. 12001/02286 suitable for Astoria/Aurora/Brasilia/Wega		

1 			
Part No.	417021	Ref. No.	N/A
description	heating element 1500W 230V heating circuits 3 mounting ø 40mm hole distance 52mm L 145mm W 34mm H 30mm hole ø 6.5mm connection male faston 6.3mm immersion heater 8 hole flange		

1 			
Part No.	417122	Ref. No.	N/A
description	heating element 1500W 230V mounting ø 42mm L 400mm heating circuits 1 connection M6 hole distance 55mm hole ø 10mm W 42mm H 44mm immersion heater tube ø 8mm 3 hole flange H1 9mm H2 35mm L1 45mm L2 50mm L3 315mm suitable for ITALCREM, VISACREM		

1 			
Part No.	417118	Ref. No.	N/A
description	heating element 1750W 230V heating circuits 1 mounting ø 30mm hole distance 44mm L 525mm W 25mm H 40mm L1 25mm L2 60mm L3 440mm H1 8mm H2 32mm hole ø 9mm tube ø 8mm connection grip connection immersion heater 3 hole flange suitable for GAGGIA		
spare parts for	417118		
	Part No.	528008	Ref. No. N/A
	gasket ID ø 30mm fibre thickness 3mm hole ø 9mm hole distance 44mm for heating element coffee machine parts		

1 			
Part No.	417152	Ref. No.	N/A
description	heating element 1900W 230V mounting ø 42mm L 590mm heating circuits 1 connection M6 hole distance 56mm hole ø 10mm W 37mm H 112mm immersion heater tube ø 8mm 3 hole flange L1 45mm L2 80mm L3 480mm suitable for VISACREM		





			
Part No.	417153	Ref. No.	N/A
description	heating element 1900W 400V mounting \varnothing 42mm L 545mm heating circuits 1 connection M6 hole distance 56mm hole \varnothing 10mm W 39mm H 99mm immersion heater tube \varnothing 8mm 3 hole flange L1 60mm L2 60mm L3 425mm suitable for VISACREM H1 8mm H2 91mm		



			
Part No.	417022	Ref. No.	N/A
description	heating element 2000W 220V heating circuits 3 mounting \varnothing 40mm hole distance 52mm L 228mm W 36mm H 34mm hole \varnothing 6mm tube \varnothing 8.5mm connection male faston 6.3mm immersion heater 6 hole flange		

			
Part No.	417349	Ref. No.	N/A
description	heating element 2000W 230V heating circuits 3 mounting \varnothing 40mm hole distance 43mm L 125mm W 33mm H 30mm immersion heater 4 hole flange		

			
Part No.	417019	Ref. No.	N/A
description	heating element 2000W 230V heating circuits 3 mounting \varnothing 40mm hole distance 43mm L 139mm W 30mm H 30mm hole \varnothing 10mm tube \varnothing 8.5mm connection male faston 6.3mm immersion heater 4 hole flange		

			
Part No.	417124	Ref. No.	N/A
description	heating element 2500W 230V mounting \varnothing 42mm L 545mm heating circuits 1 connection M6 hole distance 57mm hole \varnothing 10mm W 40mm H 42mm immersion heater tube \varnothing 8mm 3 hole flange L1 45mm L2 45mm L3 455mm suitable for ITALCREM, VISACREM H2 20mm		



			
Part No.	417105	Ref. No.	02212538
description	heating element 3700W 230V heating circuits 2 mounting \varnothing 42mm hole distance 74mm L 530mm W 28mm H 50mm L1 30mm L2 75mm L3 400mm H1 25mm H2 25mm hole \varnothing 9mm tube \varnothing 8.4mm thermostat sleeves \varnothing 7.5mm length thermostat sleeves 185mm thermostat sleeve eccentric, non clinging number of thermostat sleeves 1 connection M6 immersion heater 2 hole flange suitable for FAEMA		

			
Part No.	417020	Ref. No.	N/A
description	heating element 4000W 230V heating circuits 3 mounting \varnothing 40mm hole distance 43mm L 350mm W 32mm H 30mm hole \varnothing 9mm tube \varnothing 8mm connection male faston 6.3mm immersion heater rectangular flange		
accessories for	417020		
	Part No.	528007	Ref. No. N/A
	flat gasket PTFE ED \varnothing 50mm ID \varnothing 40mm thickness 2.5mm Qty 1 pcs		
	Part No.	528965	Ref. No. —
	flat gasket FIBER ED \varnothing 50mm ID \varnothing 40mm thickness 3mm Qty 1 pcs		

			
Part No.	526625	Ref. No.	11003362
description	heating element 4370/4760W 220/240V heating circuits 3 mounting \varnothing 40mm hole distance 51mm L 315mm W 33mm H 33mm hole \varnothing 9mm length thermostat sleeves 140mm thermostat sleeves \varnothing 6.5mm number of thermostat sleeves 1 thermostat sleeve centre not clinging tube \varnothing 8mm connection male faston 6.3mm immersion heater copper		

			
Part No.	526628	Ref. No.	4027004002
description	heating element 4370W 230V heating circuits 3 hole distance 51mm L 307mm W 32mm H 32mm hole \varnothing 9mm length thermostat sleeves 145mm thermostat sleeves \varnothing 6mm number of thermostat sleeves 1 thermostat sleeve centre not clinging tube \varnothing 6.3mm connection male faston 6.3mm immersion heater stainless steel		
accessories for	526628		
	Part No.	526674	Ref. No. 4027001000
	gasket ID \varnothing 41mm fibre thickness 2mm hole \varnothing 7.5mm hole distance 52mm suitable for GAGGIA		

			
Part No.	526624	Ref. No.	11003363
description	heating element 5000/5950W 220/240V heating circuits 3 mounting \varnothing 40mm hole distance 51mm L 405mm W 33mm H 33mm thermostat sleeves \varnothing 7mm length thermostat sleeves 140mm number of thermostat sleeves 1 thermostat sleeve centre not clinging tube \varnothing 8mm connection male faston 6.3mm immersion heater copper		

			
Part No.	417119	Ref. No.	N/A
description	heating element 5000W 220V heating circuits 2 mounting \varnothing 40mm hole distance 43mm L 398mm W 32mm H 33mm hole \varnothing 9mm connection male faston 6.3mm immersion heater 4 hole flange		
accessories for	417119		
	Part No.	528007	Ref. No. N/A
	flat gasket PTFE ED \varnothing 50mm ID \varnothing 40mm thickness 2.5mm Qty 1 pcs		



			
1			
Part No.	417110	Ref. No.	02212637
description	heating element 5000W 230V heating circuits 2 mounting ø 42mm hole distance 74mm L 525mm W 26mm H 45mm L1 25mm L2 80mm L3 420mm H1 30mm H2 15mm hole ø 10mm tube ø 8.5mm thermostat sleeves ø 7mm length thermostat sleeves 210mm thermostat sleeve eccentric, non clinging number of thermostat sleeves 1 connection M6 immersion heater 2 hole flange windings 2		

			
1			
Part No.	526627	Ref. No.	4027004003
description	heating element 5889W 240V heating circuits 3 L 405mm W 33mm H 33mm length thermostat sleeves 150mm thermostat sleeves ø 6mm number of thermostat sleeves 1 thermostat sleeve centred, adjacent tube ø 6.3mm connection male faston 6.3mm immersion heater stainless steel		

heating cartridges

			
1			
Part No.	418985	Ref. No.	WGADM2125/01
description	heating cartridge 80W 240V ø 12.7mm L 55mm connection 2x female faston 6.3mm cable length 60mm brewing unit		

			
1			
Part No.	400338	Ref. No.	DM1804/001
description	heating cartridge 80W 240V ø 12.7mm L 55mm connection cable length 60mm		

flow heaters

			
1			
Part No.	419226	Ref. No.	EF0030/02/A
description	boiler 120/240VACV		

accessories

sealing washers

fibre gaskets

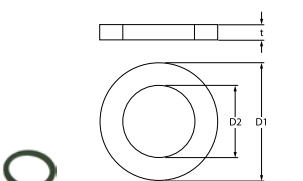
			
1			
Part No.	528009	Ref. No.	N/A
description	gasket fibre		

PTFE gaskets

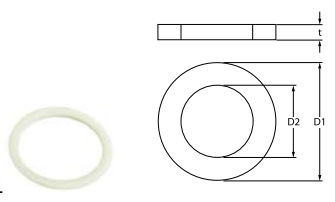
			
1			
Part No.	528007	Ref. No.	N/A
description	flat gasket PTFE ED ø 50mm ID ø 40mm thickness 2.5mm Qty 1 pcs		

flange gaskets



			
1			
Part No.	528008	Ref. No.	N/A
description	gasket ID ø 30mm fibre thickness 3mm hole ø 9mm hole distance 44mm for heating element coffee machine parts		

			
1			
Part No.	526674	Ref. No.	4027001000
description	gasket ID ø 41mm fibre thickness 2mm hole ø 7.5mm hole distance 52mm suitable for GAGGIA		

thermostats

bi-metal thermostats

safety bi-metal thermostats

			
1			
Part No.	390369	Ref. No.	189428200
description	bi-metal safety thermostat hole distancemm switch-off temp. 175°C 1NC 1-pole 16A connection F6.3		
accessories for	390369		
	Part No.	504736	Ref. No.
			—
	 bracket for contact thermostat		

bi-metal thermostats

			
1			
Part No.	390697	Ref. No.	WGADM1561
description	bi-metal thermostat hole distancemm switch-off temp. 103°C 1NC 1-pole 10A 250V connection F6.3 M4		



			
1			
Part No.	390152	Ref. No.	DM.1168 DM.1288
description	bi-metal thermostat hole distancemm switch-off temp. 107°C 1NC 1-pole 16A connection F6.3 M4		

control and safety thermostats

EGO

safety thermostats

55.11_ series

			
1			
Part No.	390696	Ref. No.	5008006000
description	safety thermostat switch-off temp. 153°C 1-pole 1NC probe ø 6mm probe L 78mm capillary pipe 880mm capillary pipe isolated 880mm gland nut probe probe material SS		

55.32_ series

			
1			
Part No.	390324	Ref. No.	07476906
description	safety thermostat switch-off temp. 169°C 3-pole 3NC 20A probe ø 4mm probe L 128mm capillary pipe 890mm capillary pipe isolated 210/210mm gland nut probe SS		

			
1			
Part No.	390695	Ref. No.	5024007000
description	safety thermostat switch-off temp. 170°C 3-pole 3NC probe ø 6mm probe L 74mm capillary pipe 900mm capillary pipe isolated 900mm gland nut starting temperature 156°C probe material SS		

IMIT / TEMPOMATIC / ARATHERMO

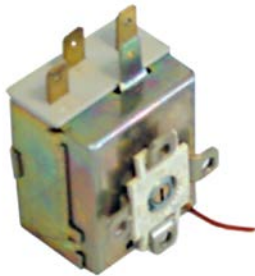

control thermostats

			
1			
Part No.	390339	Ref. No.	DM687
description	thermostat temperature range 30-120°C 1-pole 1CO 15A probe ø 6.5mm probe L 85mm capillary pipe 900mm capillary pipe isolatedmm gland nut 250V		

switches and momentary switches

rocker/momentary rocker switches

30x22mm

			
1			
Part No.	301001	Ref. No.	5008002000
description	rocker switch mounting measurements 30x22mm red 2NO 250V 16A illuminated 0-I connection male faston 6.3mm ambient temperature max. 125/55°C protection IP65		
accessories for	301001		
	Part No.	301036	Ref. No. —
	protective cover internal size 30x22mm for rocker switch mounting measurementsmm		

			
1			
Part No.	347252	Ref. No.	DM1362/RO
description	rocker switch mounting measurements 30x22mm red 2-pole 2NO 250V 10A + lamp cup connection male faston 6.3mm		

push/momentary push switches

19x13mm

			
1			
Part No.	347261	Ref. No.	WGA4001080000
description	element holder VA connection suitable for switch 19x13		





1

Part No.	347260	Ref. No.	WGA5001001000
description	switch mounting measurements 19x13mm 2NO 250V 16A connection male faston 6.3mm ambient temperature max. 125/55°C protection IP40		
accessories for	347260		
	Part No.	347261	Ref. No.
	element holder VA connection suitable for switch 19x13		



1

Part No.	347257	Ref. No.	WGA5302001000
description	switch mounting measurements 19x13mm red 1NO 250V 16A connection male faston 6.3mm ambient temperature max. 125/55°C protection IP40		
accessories for	347257		
	Part No.	347261	Ref. No.
	element holder VA connection suitable for switch 19x13		

Ø25mm



1

Part No.	345162 ¹	Ref. No.	WGADM2104
description	push switch mounting Ø 25mm yellow 2NO 250V 16A illuminated connection male faston 6.3mm ambient temperature max. 85°C protection IP40		

¹illuminated

miscellaneous



1

Part No.	347417	Ref. No.	12001020
description	push switch mounting measurements 19x13mm white 2NO 250V 16A connection male faston 6.3mm ambient temperature max. 125/55°C protection IP40		



1

Part No.	347259	Ref. No.	WGA5001009000
description	switch mounting Ø 19x13mm 1NO 250V 16A momentary connection male faston 6.3mm ambient temperature max. 85°C protection IP40		
accessories for	347259		
	Part No.	347261	Ref. No.
	element holder VA connection suitable for switch 19x13		

system switches (ROLD)



1

Part No.	347182	Ref. No.	5024009000
description	element holder mounting measurements 20.6x16.4mm chrome-plated arched for push buttons 13x17mm		



1

Part No.	347256	Ref. No.	5027014000
description	element holder Ø 25mm chrome-plated		



1

Part No.	345130	Ref. No.	12000723 5024003000
description	momentary switch unit 1NO 250V 16A connection male faston 6.3mm		





1

Part No.	347255	Ref. No.	5027015000
description	push button Ø 21mm chrome-plated edition		



1

Part No.	347181	Ref. No.	5024010000
description	push button size 13x17mm chrome-plated		
accessories for	347181		
	Part No.	347182	Ref. No.
	element holder mounting measurements 20.6x16.4mm chrome-plated arched for push buttons 13x17mm		



1

Part No.	345722	Ref. No.	5024006000
description	switch 1NO 250V 16A connection male faston 6.3mm		



			
1			
Part No.	345720	Ref. No.	5024008000
description	switch 2NO 250V 16A connection male faston 6.3mm		

rotary switches

BREMAS

A1700 series

			
1			
Part No.	347487 ¹	Ref. No.	N/A
description	rotary switch 3 1-0-2 sets of contacts 4 type CA0200006P2 400V 25A shaft ø 5x5mm shaft L 24mm shaft square connection screw		

¹incl. knob and dial plate

A2000 series

			
1			
Part No.	346054	Ref. No.	N/A
description	rotary switch 1-0-2 20A shaft ø 5x5mm shaft L 24mm 3 operating positions 4-pole		

A2500 series

			
1			
Part No.	347251	Ref. No.	WGADM1944
description	rotary switch 4 0-1-2-3 sets of contacts 6 type CS0258542 600V 32A shaft ø 5x5mm shaft L 27mm shaft square connection screw 4 operating positions		

accessories

			
1			
Part No.	111012	Ref. No.	12000822
description	knob switch zero mark t.max.°C ø 34/60mm shaft ø 5x5mm shaft flat black H 22mm L 50mm		

miscellaneous

			
1			
Part No.	347604	Ref. No.	DM0781 P310802
description	rotary switch 4 0-1-2-3 sets of contacts 6 690V 32A shaft ø 5x5mm shaft L 27mm shaft square kit connection cable		
spare parts for	347604		
	Part No.	347251	Ref. No. WGADM1944
description	rotary switch 4 0-1-2-3 sets of contacts 6 type CS0258542 600V 32A shaft ø 5x5mm shaft L 27mm shaft square connection screw 4 operating positions		

miscellaneous

			
1			
Part No.	347253	Ref. No.	DM0781
description	rotary switch 0-1-2 25A shaft L 21mm connection screw ø 43mm 6-pole P300802 VM shaft 5x5mm		

lamps

indicator lights

indicator lights (complete)

ø 9mm

			
1			
Part No.	359135	Ref. No.	5008005000
description	indicator light ø 9mm 230V red connection male faston 6.3mm temp.-resist. 120°C with lens		

			
1			
Part No.	359484	Ref. No.	5027013000
description	indicator light ø 9mm 240V blue connection plug-in connection temp.-resist. 120°C		

ø25mm

			
1			
Part No.	359202	Ref. No.	WGA5001012000
description	indicator light ø 25mm 230V red connection male faston 6.3mm		



20x13mm



1

Part No.	347262	Ref. No.	DM2044
description	indicator light mounting measurements 20x13mm 230V green connection male faston 4.8mm temp.-resist. 125°C		

miscellaneous



1

Part No.	359485	Ref. No.	WGA5001010000
description	indicator light 230V connection male faston 6.3mm cable length 200mm ambient temperature max. 120°C		
spare parts for	359485		
	Part No.	359833	Ref. No. —
	indicator light lens red Qty 1 pcs ø 8mm		

contactors

ABB

power contactors



1

Part No.	380104	Ref. No.	5027002000
description	power contactor resistive load 25A 230VAC (AC3/400V) 9A/4kW main contacts 3NO auxiliary contacts 1NO connection screw connection type A9-30-10		

relays

power relays

with bracket mounting



1

Part No.	380052	Ref. No.	WGADM2122
description	power relays 230VAC 25A 2NO connection male faston 6.3mm flange support		

level relays

GICAR



1

Part No.	402103	Ref. No.	DM1940/04
description	level controller 230/240V voltage AC 50/60Hz connection F6.3 type NRL30/1E-2C/F		



1

Part No.	402331	Ref. No.	WGADM1940
description	level controller 230V voltage AC 50/60Hz 5A connection male faston 6.3mm type RL30/1E-2C/F		

GIEMME



1

Part No.	402332	Ref. No.	5008003000
description	level controller 230V voltage AC 50/60Hz 10/5/16A connection male faston 6.3mm type RLO 1E/1S/4C/F		

electronics

PCBs



1

Part No.	402338	Ref. No.	5027003000
description	display PCB		



central units



1

Part No.	402784	Ref. No.	DM2181/02/230
description	central unit 2-group 230V 50/60Hz type 3d5 MAESTRO 2GRCTZ		



1

Part No.	402334	Ref. No.	DM2182/02/230
description	central unit 2-group 230V dosing + level control type 3d5 Maestro 2GRCTZD voltage AC		



1

Part No.	402336	Ref. No.	5027001000
description	central unit 3-group 230V dosing + level control voltage AC		



1

Part No.	402337	Ref. No.	DM2182/3/230
description	central unit 3-group 230V dosing + level control voltage AC		



1

Part No.	402335	Ref. No.	12000669
description	central unit 4-group 230V dosing + level control voltage AC		

dosing electronics

GICAR



1

Part No.	402330	Ref. No.	5014004000
description	dosing electronics 2-group 230V voltage AC 50/60Hz type RL30 MICRO Z		

keypads

keypad units



1

Part No.	402342	Ref. No.	8027063000
description	keypad unit buttons 2 round		



1

Part No.	402344	Ref. No.	8001073000
description	keypad unit buttons 5		





1

Part No.	402345	Ref. No.	8003023000
description	keypad unit buttons 5		



			
1			
Part No.	402786	Ref. No.	8001051000
description	keypad unit buttons 5 lighting white L 122mm W 46mm		

			
1			
Part No.	402341	Ref. No.	WGA8003007000
description	keypad unit buttons 5 oval		

			
1			
Part No.	402351	Ref. No.	8001051000
description	keypad unit buttons 5 oval		

			
1			
Part No.	402340	Ref. No.	8027061000
description	keypad unit buttons 5 round		

accessories

			
1			
Part No.	526633	Ref. No.	WGA6003016000
description	button oval L 17mm W 14mm H 10mm chrome-plated		

			
1			
Part No.	526632	Ref. No.	6001024000
description	button oval L 21mm W 17mm H 14mm chrome-plated		

solenoid valves

solenoid valves (water)

metal

PARKER

2-way

E-146 series



1			
Part No.	370679	Ref. No.	DM1197 DM1197/220/5060
description	solenoid valve 2-ways 230VAC connection 1/4" DN 1.5mm slide-on receptacle DIN -20° up to 130°C PARKER type series VE146V coil type ZB09 membranes FKM (water) p max 40bar		



1			
Part No.	370564	Ref. No.	WGADM2115
description	solenoid valve 2-ways 230VAC inlet 1/4" outlet 1/4" connection 1/4" L 40mm DN 2.5mm slide-on receptacle DIN -20° up to 130°C PARKER type series VE-146 coil type ZB09 membranes FKM (water) p max 15bar 50/60Hz brass		

3-way

VE-128 series



1			
Part No.	370057	Ref. No.	WGADM0647
description	solenoid valve 3-ways 230VAC body outer cone DN 1.2mm slide-on receptacle DIN -20° up to 140°C PARKER type series VE-128 coil type ZB09 membranes ruby p max 10bar brass flange 32x32mm		

spare parts for	370057			
	Part No.	370062	Ref. No.	—
	solenoid valve body PARKER 3-ways outer cone			

	Part No.	371029	Ref. No.	—
	solenoid coil PARKER 230VAC 9VA coil type ZB09 seat ø 14mm H 33mm W 34mm D 43mm			

accessories for	370057			
	Part No.	371090	Ref. No.	—
	power socket plug type DIN 43650A screw			





	Part No.	371095	Ref. No.	—
	O-ring Viton thickness 1.78mm ID ø 6.07mm Qty 1 pcs			

Table continues overleaf



accessories for	370057			
	Part No.	371100	Ref. No.	—
	O-ring silicone thickness 1.78mm ID ø 6.07mm Qty 1 pcs			

Solenoid valve - accessories

	1			
Part No.	528952	Ref. No.	18G1511/01	
description	mounting plate for solenoid valve			
accessories for	528952			
	Part No.	528954	Ref. No.	—
	nozzle hole ø 0.8mm thread M6 thread L 6mm brass			

pressure switches

for coffee machines

ø 33mm

	1		
Part No.	541745	Ref. No.	S451308
description	pressure control ø 33mm pressure range 0.5-1.2bar 16A 250V coffee machine parts connection 1/4" 1NC ambient temperature max. 125°C pressure connection 1/4"		

ø 38mm



	1		
Part No.	541153	Ref. No.	5008001000
description	pressure control ø 38mm pressure range 1-2.5bar pressure connection vertical preset at 1.2bar 16A 250V coffee machine parts connection 1/4" pressure connection 1/4" GAS		

pumps

booster pumps II



pump heads

FLUID-O-TECH

	1			
Part No.	500064	Ref. No.	N/A	
description	pump head P0204 FLUID-O-TECH L 82mm 200l/h connection 3/8" GAS with bypass brass clip connection for coffee machine shaft ø 4.8x11mm			
accessories for	500064			
	Part No.	520126	Ref. No.	—
	clamp for pump/motor			



vibration pumps

	1		
Part No.	500232	Ref. No.	N/A
description	vibration pump type 1106PAAAM1N 24V 50/60Hz 45W inlet ø 1/8" IT outlet ø 1/8" IT L 129mm FLUID-O-TECH		

	1			
Part No.	500217	Ref. No.	N/A	
description	vibration pump type 1106PAALB2N 230V 50Hz 70W inlet ø 1/8" IT outlet ø 1/8" IT outlet conical L 129mm with bypass FLUID-O-TECH			
spare parts for	500217			
	Part No.	520250	Ref. No.	—
	by-pass thread 1/8" IT T2: M12x1 IG			





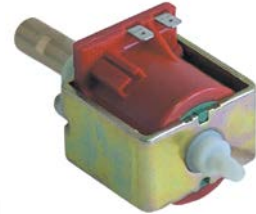

1

Part No.	500123	Ref. No.	N/A
description	vibration pump type 1106PAALM1N 230V 50Hz 70W inlet \varnothing 1/8" IT outlet \varnothing 1/8" IT outlet conical L 129mm FLUID-O-TECH		
accessories for	500123		
	Part No.	371090	Ref. No. —
	power socket plug type DIN 43650A screw		
	Part No.	371120	Ref. No. —
	diode type IN5408		
	Part No.	390698	Ref. No. —
	thermal fuse switch-off temp. 110°C suitable for ULKA pump		



1

Part No.	500124	Ref. No.	N/A
description	vibration pump type EX 5 230V 48W 50/60Hz inlet \varnothing 6 outlet \varnothing 1/8" IT flat seal ULKA brass L 123mm		
accessories for	500124		
	Part No.	520152	Ref. No. —
	hose connector Santoprene grommet \varnothing 7mm grommet length 14mm		
	Part No.	520330	Ref. No. —
	bracket rubber dimensions 69x44x4mm		



1

Part No.	500219	Ref. No.	N/A
description	vibration pump type CP.3A.958.1/ST 230V 65W 50Hz inlet \varnothing 6 outlet \varnothing 1/8" IT EATON (INVENSYS) L 123mm		

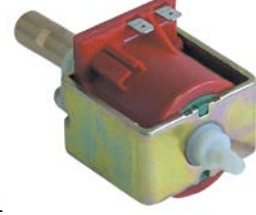

1

Part No.	500179	Ref. No.	N/A
description	vibration pump type EX 5 24V 48W 50/60Hz inlet \varnothing 6 outlet \varnothing 1/8" IT ULKA outlet flat brass L 123mm		

equipment-specific units for espresso machines

filter holders

filter holders standard

filter holders (complete)



1

Part No.	500173	Ref. No.	DM1594/230/240
description	vibration pump type EP 5 230V 48W 50Hz inlet \varnothing 6 outlet \varnothing 1/8" IT ULKA outlet flat plastic L 123mm		



1

Part No.	525974	Ref. No.	8027086000
description	filter holder with outlet, 2-fold suitable for GAGGIA ID \varnothing 6.1mm outlet distance 48mm mounting \varnothing 79		



1

Part No.	500178	Ref. No.	853-8372211
description	vibration pump type EP 5 24V 48W 50/60Hz inlet \varnothing 6 outlet \varnothing 1/8" IT ULKA outlet flat plastic L 123mm		



 <p>1</p>			
Part No.	525973	Ref. No.	
description	filter holder with outlet, single suitable for GAGGIA 1-way ID ø 61mm outlet distancemm mounting ø 79		

filter holder without spout			
 <p>1</p>			
Part No.	525979	Ref. No.	N/A
description	filter holder suitable for GAGGIA without outlet mounting ø 79mm outlet 3/8" ID ø 61.4mm wedge hight 10mm wedge position diagonal number of wedges 2 lever straight		

 <p>1</p>			
Part No.	525972	Ref. No.	6027004000
description	filter holder suitable for GAGGIA without outlet mounting ø 79mm outlet 3/8" ID ø 61mm wedge hight 10mm wedge position diagonal number of wedges 2 lever straight		

 <p>1</p>			
Part No.	531123	Ref. No.	N/A
description	filter holder suitable for GAGGIA without outlet mounting ø 79mm outlet 3/8" ID ø 61mm wedge hight 10mm wedge position diagonal number of wedges 2 lever straight		

filter holders short			
 <p>1</p>			
Part No.	531186	Ref. No.	26G0104 Original WGA26G0104
description	filter holder mounting ø 79mm outlet 3/8" ID ø 61mm handle M10x1.5 wedge hight 7.5mm wedge position diagonal number of wedges 2 lever straight chrome-plated brass		

filter holders long			
 <p>1</p>			
Part No.	529054	Ref. No.	N/A
description	filter holder mounting ø 78.8mm outlet 3/8" ID ø 61mm handle M10 wedge hight 10mm wedge position diagonal number of wedges 2 lever straight		

handles			
with external thread			
 <p>1</p>			
Part No.	531187	Ref. No.	8001061000 Original
description	handle for filter holder ø 30mm thread M10x1.5 thread L 18mm L 125mm black plastic/rubber		

with bore			
 <p>1</p>			
Part No.	529056	Ref. No.	N/A
description	handle ø 35mm aperture 14x14mm L 117mm black		

filters			
for 1 cup			
 <p>1</p>			
Part No.	529021	Ref. No.	N/A
description	coffee filter ø 68mm mounting ø 60.5mm H 24mm cups 1 amount of coffee 7g		





1

Part No.	526664	Ref. No.	WGANF08/002/B
description	coffee filter ø 69.5mm mounting ø 60.8mm H 20mm cups 1 amount of coffee 6.5g SS		



1

Part No.	526665	Ref. No.	WGANF08/004/B
description	coffee filter ø 69.5mm mounting ø 60.8mm H 24mm cups 1 amount of coffee 7g SS		



1

Part No.	529077	Ref. No.	N/A
description	coffee filter ø 69mm mounting ø 60.8mm H 24.3mm cups 1 amount of coffee 7g ECONOMY 18/0		

for 2 cups



1

Part No.	529022	Ref. No.	NF08/005 NF08/005/B
description	coffee filter ø 68mm mounting ø 60.5mm H 24.5mm cups 2 amount of coffee 14g		



1

Part No.	526666	Ref. No.	WGANF08/005/B
description	coffee filter ø 69.5mm mounting ø 60.8mm H 24.5mm cups 2 amount of coffee 12-14g		

filter holder springs



1

Part No.	531243	Ref. No.	WGA25G0075
description	filter holder spring L 70mm W 60mm wire gauge ø 1.3mm for espresso filter holder Qty 20 pcs		

brewing units

shower screens

flat



1

Part No.	529087	Ref. No.	WGADM0269
description	shower screen ø 55mm hole ø 5.2mm		

screws



1

Part No.	560397	Ref. No.	WGADI0964-5X8I
description	oval head screw thread M5 thread L 5mm stainless steel Qty 1 pcs head ø 9mm L 8mm		

filter holder gaskets

flat

with external notch



1

Part No.	526667	Ref. No.	WGANG01/001/B
description	filter holder gasket with outside notch D1 ø 72.3mm D2 ø 56mm H 8.5mm with outside notch Qty 1 pcs		

standard



1

Part No.	528064	Ref. No.	N/A
description	filter holder gasket D1 ø 72mm D2 ø 56mm H 9mm		

with bevel 45x2



1

Part No.	528042	Ref. No.	N/A
description	filter holder gasket with bevel 45x2 D1 ø 72mm D2 ø 56mm H 8mm		

mechanical components,
equipment accessories

1



filter holder supports



1

Part No.	698785	Ref. No.	8G251
description	bracket ED \varnothing 39.5mm ID \varnothing 14.5x31mm H 26mm for filter holder		

water dispersions

water dispersions

group 3



1

Part No.	529166	Ref. No.	16G1002
description	water distributor \varnothing 58.3 / 53.4mm H 15.5mm 4 holes hole \varnothing 1.75mm thread M5 mounting \varnothing 6.6mm bore \varnothing 10.4mm brass		

safety valves

safety valves

3/8"



1

Part No.	526645	Ref. No.	WGADM2184/A
description	safety valve connection 3/8" triggering pressure 1.8bar		



1

Part No.	526649	Ref. No.	8008016000
description	safety valve connection 3/8" triggering pressure 1.9bar L 70mm hose \varnothing 7mm		

metric thread



1

Part No.	529308	Ref. No.	WGADM1380/003
description	safety valve connection M19x1 triggering pressure 1.8bar		

expansion valves

with hose connection



1

Part No.	526650	Ref. No.	WGADM0262/003
description	expansion valve T1: 3/8" IT hose \varnothing 7mm triggering pressure 11bar L 70mm		

drain pans

drain pans



1

Part No.	525494	Ref. No.	AS0180/A
description	drain pan L 90mm W 90mm H 34mm hose \varnothing 16mm		



1

Part No.	526669	Ref. No.	AS0180/01/A
description	drain pan L 90mm W 90mm H 34mm hose \varnothing 16mm		



1

Part No.	526668	Ref. No.	WGA4001097000
description	drain pan L 97mm W 90mm H 47mm hose \varnothing 12mm		

accessories



1



Part No.	526670	Ref. No.	WGA4001099000
description	collector L 100mm W 42mm H 39mm hose \varnothing 8mm		



			
1			
Part No.	526671	Ref. No.	AS0062
description	connection angle hose ø 16mm		

			
1			
Part No.	526673	Ref. No.	WGA5001021000
description	hose connector plastic hose ø 15-15mm angled L 48mm W 48mm		

aerators and air bleeders

			
1			
Part No.	529303	Ref. No.	WGADM2186
description	aerator and air bleeder connection 1/4" only steam		
spare parts for	529303		
	Part No.	528687	Ref. No.
	 O-ring Viton thickness 1.78mm ID ø 3.69mm Qty 1 pcs		

boilers

gaskets

O-rings

			
1			
Part No.	528678	Ref. No.	N/A
description	gasket set 4-piece		

steam/water taps

steam/water taps

steam/water taps

			
1			
Part No.	526641	Ref. No.	RB0740/A
description	tap body mounting pos. left/right steam/water		

			
1			
Part No.	526642	Ref. No.	WGA8001027000
description	tap body mounting pos. left/right steam/water		

components

gaskets

			
1			
Part No.	526681	Ref. No.	WGARB0902
description	gasket D1 ø 14.5mm D2 ø 6.5mm thickness PTFEmm H 9mm		

			
1			
Part No.	528695	Ref. No.	WGARB0709
description	gasket D1 ø 15mm D2 ø 6.8mm thickness 6.3mm for tap		

springs

			
1			
Part No.	526685	Ref. No.	WGARB0712
description	compression spring ø 14.3mm L 30.5mm wire gauge ø 1.8mm		

water taps

water taps

			
1			
Part No.	526640	Ref. No.	700800400
description	water tap mounting pos. left/right with knob pipe chrome-plated brass		



steam/water pipes

steam pipes



1

Part No.	526634	Ref. No.	11006178
description	steam pipe complete L 165mm tube ø 10mm stainless steel		



1

Part No.	526636	Ref. No.	7008003000
description	steam pipe L 100mm tube ø 6mm chrome-plated brass		



1

Part No.	526635	Ref. No.	11011247
description	steam pipe with PTFE gasket L 180mm tube ø 10mm stainless steel		

nozzles for steam pipes



1

Part No.	526672	Ref. No.	8301006000
description	steam nozzle ø 17mm L 85mm 1 holes plastic for pipe ø 6mm		

nozzles for water pipes

nozzles for water pipes



1

Part No.	526637	Ref. No.	11004974 9V387
description	water nozzle D1 ø 24mm H 29mm int. ø 1 9mm		

tap aerators



1

Part No.	526638	Ref. No.	WGA5001005000
description	tap aerator D1 ø 19mm D2 ø 21mm H 12mm		

water pipes



1

Part No.	526639	Ref. No.	WGA7009002000
description	water pipe ø 15mm L 33mm chrome-plated brass		

accessories

gaskets



1

Part No.	528402	Ref. No.	DM0041/030
description	O-ring Viton thickness 2.62mm ID ø 10.78mm Qty 1 pcs		

springs



1

Part No.	526687	Ref. No.	WGARB0882
description	compression spring ø 12mm L 22mm wire gauge ø 1.6mm steel for steam-/water-tap		

tube handles



1

Part No.	526652	Ref. No.	4001144000
description	tube handle ø 7mm L 32mm plastic		

intake valves

intake valves



1

Part No.	526251	Ref. No.	WGA8001033000
description	intake valve with lever		





1

Part No.	526643	Ref. No.	11006180
description	intake valve with lever		





			
1			
Part No.	526644	Ref. No.	8024029000
description	intake valve with lever		

accessories			
bolts			
			
1			
Part No.	526684	Ref. No.	WGARB0844
description	bolt ø 5mm L 20mm brass for lever		

springs			
			
1			
Part No.	526686	Ref. No.	WGA4001089000
description	compression spring ø 12.5mm L 43.5mm wire gauge ø 1.2mm		

levers			
			
1			
Part No.	526651	Ref. No.	WGARB0843
description	lever for filling valve L 92mm		

			
1			
Part No.	526660	Ref. No.	RB0642
description	lever joint for filling valve		

valves			
			
1			
Part No.	526683	Ref. No.	WGA8001072000
description	non-return valve for filling valve L 16.3mm brass		

level glasses			
level glasses			
gaskets			
			
1			
Part No.	526678	Ref. No.	WGA4001076000
description	gasket D1 ø 16.5mm D2 ø 12mm H 11mm		

pressure rings			
			
1			
Part No.	528682	Ref. No.	LV0506
description	press ring D1 ø 15mm D2 ø 11.6mm thickness 3.2mm brass		

level glass pipes			
			
1			
Part No.	526630	Ref. No.	LV0541
description	water level tube ø 11mm H 95mm marking white/red		

			
1			
Part No.	526663	Ref. No.	WGA4001060000
description	water level tube ø 12mm H 107mm marking white/red		

			
1			
Part No.	529062	Ref. No.	11006045
description	water level tube ø 12mm H 134.5mm marking white/red		

miscellaneous			
			
1			
Part No.	526680	Ref. No.	4008036000
description	nozzle D1 ø 12mm D2 ø 8.5mm H 6mm bore ø 1.5mm		

screw connections			
			
1			
Part No.	526677	Ref. No.	WGA4001075000
description	union nut thread M20 hole ø 13mm H 14mm WS 23 brass		

			
1			
Part No.	526676	Ref. No.	LV0505
description	union screw thread 3/8" hole ø 12mm H 12mm WS 17 chrome-plated brass		



non-return valves

complete



1

Part No.	526648	Ref. No.	5024001000
description	non-return valve inlet 1/4" ET outlet 1/4" IT L 61mm		



1

Part No.	526647	Ref. No.	WGADM2198
description	non-return valve inlet 3/8" ET outlet 1/4" IT L 61mm		

for coffee grinders

grinding burrs

grinding burrs straight

standard



1

Part No.	527244	Ref. No.	N/A
description	grinding burrs pair turn direction right D1 ø 50mm ID ø 30mm H 7.5mm tooth spacing 2.5mm hole ø 4.5mm bore ø 7.5mm mounting ø 40 straight suitable for GAGGIA, BABY		

coffee beans containers

supports



1

Part No.	531170	Ref. No.	9M877
description	support for coffee beans container intake conical seat ø 63-62mm suitable for GAGGIA		

EQUIPMENT-SPECIFIC UNITS/KNOBS GAGGIA

knobs

steam/water taps

steam/water taps



1

Part No.	111065	Ref. No.	N/A
description	knob ø 43mm shaft ø 8x8mm black		

accessories for 111065

	Part No.	111066	Ref. No.	—
	description	knob spring		



1

Part No.	526655	Ref. No.	RB0907/A
description	turning handle ø 43mm black with spring		



1

Part No.	526654	Ref. No.	WGA4001085000 WGA8001028000
description	turning handle ø 47mm black		



1

Part No.	526653	Ref. No.	8027044000
description	turning handle ø 47mm black/chrome		

knob dial plates



1

Part No.	526656	Ref. No.	WGADM0794/003
description	knob dial plate steam black/silver ø 14mm self-adhesive		



1

Part No.	526657	Ref. No.	DM0794/001
description	knob dial plate steam self-adhesive ø 15mm black/red		



1

Part No.	526658	Ref. No.	WGADM0793/003
description	knob dial plate water ø 14mm self-adhesive		





			
1			
Part No.	526659	Ref. No.	DM0793/001
description	knob dial plate water self-adhesive ø 15mm black/red		

gaskets

O-rings

EPDM			
			
1			
Part No.	361304	Ref. No.	WGADM0041/053
description	O-ring EPDM ID ø 11.11mm thickness 1.78mm Qty 1 pcs for type DIB3E/DIB5E		

			
1			
Part No.	507309	Ref. No.	WGADM0041/066
description	O-ring EPDM thickness 2.62mm ID ø 17.13mm Qty 1 pcs		

			
1			
Part No.	532453	Ref. No.	DM0041/083
description	O-ring EPDM thickness 2.62mm ID ø 21.89mm Qty 1 pcs		

silicone			
			
1			
Part No.	532190	Ref. No.	140321462
description	O-ring silicone thickness 1.78mm ID ø 4.48mm Qty 10 pcs		

			
1			
Part No.	532562	Ref. No.	WGADM0041/063
description	O-ring silicone thickness 2.62mm ID ø 20.63mm Qty 1 pcs		

Viton			
			
1			
Part No.	532565	Ref. No.	WGADM0041/107
description	O-ring Viton thickness 1.78mm ID ø 15.6mm Qty 1 pcs		

			
1			
Part No.	528687	Ref. No.	WGADM0041/032
description	O-ring Viton thickness 1.78mm ID ø 3.69mm Qty 1 pcs		

			
1			
Part No.	528402	Ref. No.	DM0041/030
description	O-ring Viton thickness 2.62mm ID ø 10.78mm Qty 1 pcs		

			
1			
Part No.	528291	Ref. No.	WGADM0041/106
description	O-ring Viton thickness 2.62mm ID ø 11.91mm Qty 1 pcs		

			
1			
Part No.	532563	Ref. No.	WGADM0041/093
description	O-ring Viton thickness 3.53mm ID ø 41.28mm Qty 1 pcs		

			
1			
Part No.	532564	Ref. No.	WGADM0041/093
description	O-ring Viton thickness 3.53mm ID ø 41.28mm Qty 10 pcs		



sealing washers

rubber gaskets



1

Part No.	526631	Ref. No.	WGA4001094000
-----------------	--------	-----------------	---------------

description	flat gasket rubber ED ø 24mm ID ø 15mm thickness 3mm Qty 1 pcs
--------------------	--

PTFE gaskets



1

Part No.	526679	Ref. No.	WGA4001077000
-----------------	--------	-----------------	---------------

description	flat gasket PTFE ED ø 18mm ID ø 13mm thickness 2mm Qty 1 pcs
--------------------	--



1

Part No.	528007	Ref. No.	N/A
-----------------	--------	-----------------	-----

description	flat gasket PTFE ED ø 50mm ID ø 40mm thickness 2.5mm Qty 1 pcs
--------------------	--

special gaskets

group gaskets



1

Part No.	528132	Ref. No.	N/A
-----------------	--------	-----------------	-----

description	group gasket L 68mm W 68mm thickness 2.5mm suitable for GAGGIA hole distance 49mm
--------------------	---

springs

compression springs



1

Part No.	526686	Ref. No.	WGA4001089000
-----------------	--------	-----------------	---------------

description	compression spring ø 12.5mm L 43.5mm wire gauge ø 1.2mm
--------------------	---



1

Part No.	526687	Ref. No.	WGARB0882
-----------------	--------	-----------------	-----------

description	compression spring ø 12mm L 22mm wire gauge ø 1.6mm steel for steam-/water-tap
--------------------	--



1

Part No.	526685	Ref. No.	WGARB0712
-----------------	--------	-----------------	-----------

description	compression spring ø 14.3mm L 30.5mm wire gauge ø 1.8mm
--------------------	---

manometers



1

Part No.	541707	Ref. No.	WGA5001018000
-----------------	--------	-----------------	---------------

description	manometer double scale ø 63mm pressure range 0-2.5 / 0-16bar connection on the backside thread 1/8"
--------------------	---



1

Part No.	541843	Ref. No.	DM1600
-----------------	--------	-----------------	--------

description	manometer ø 39mm pressure range 0-3bar thread 1/8" marking 1.9-2.1 connection rear
--------------------	--



1

Part No.	541228	Ref. No.	N/A
-----------------	--------	-----------------	-----

description	manometer ø 41mm pressure range 0 up to 15bar thread 1/8" marking 7-8 connection on the backside
--------------------	--



1

Part No.	541714	Ref. No.	DM1600/002
-----------------	--------	-----------------	------------

description	manometer ø 41mm pressure range 0-3bar thread 1/4" marking 1.4-2.1 capillary pipe 430mm
--------------------	---



1

Part No.	541715	Ref. No.	5024005000
-----------------	--------	-----------------	------------

description	manometer ø 41mm pressure range 0-3bar thread 1/4" marking 1.8-3 capillary pipe 430mm
--------------------	---

1

Part No.	541229	Ref. No.	DM1600
description	manometer ø 44mm pressure range 0 up to 3bar thread 1/8" marking 2 connection on the backside		



1

Part No.	541244	Ref. No.	N/A
description	manometer ø 52mm pressure range 0 up to 3bar thread 1/4" marking 1.1-1.3 connection on the backside		



1

Part No.	541217	Ref. No.	3320024
description	manometer ø 49.3mm pressure range 0 up to 3bar thread 1/8" marking 2 connection on the backside		



1

Part No.	541214	Ref. No.	3320022
description	manometer ø 52mm pressure range 0 up to 3bar thread 1/8" connection on the backside		



1

Part No.	541245	Ref. No.	N/A
description	manometer ø 50mm pressure range 0 up to 24bar thread 1/4" marking 8-10 connection on the backside		



1

Part No.	541215	Ref. No.	N/A
description	manometer ø 53mm pressure range 0 up to 16bar thread 1/8" marking 8-10 connection on the backside		



1

Part No.	541789	Ref. No.	N/A
description	manometer ø 50mm pressure range 0 up to 12bar thread 1/4" marking 2-2.4 connection on the backside		



1

Part No.	541216	Ref. No.	ELE 80
description	manometer ø 53mm pressure range 0 up to 16bar thread 1/8" marking 8-10 connection on the backside		



1

Part No.	541284	Ref. No.	N/A
description	manometer ø 52mm pressure range 0 up to 15bar connection on the backside marking 6/7 thread 1/4"		



1

Part No.	541219	Ref. No.	N/A
description	manometer ø 60mm pressure range 0 up to 16bar thread 1/8" marking 8-10 connection on the backside		



1

Part No.	541283	Ref. No.	3320026
description	manometer ø 52mm pressure range 0 up to 3bar connection on the backside marking 1-1.5 thread 1/4"		



1

Part No.	541218	Ref. No.	N/A
description	manometer ø 60mm pressure range 0 up to 3bar thread 1/8" marking 1.5-2 connection on the backside		



1

Part No.	541716	Ref. No.	5024004000
description	manometer pressure range 0-15bar ø 41mm connection 1/4" marking 7-9/12.5-15 capillary pipe 880mm for pump		



1

Part No.	541706	Ref. No.	5014001000
description	manometer pressure range 0-2.5bar ø 63mm connection on the backside thread 1/8" ED ø 70mm		



1

Part No.	541237	Ref. No.	N/A
description	manometer thread 1/4" pressure range 0 up to 3bar black marking 1 connection on the backside		



1

Part No.	541236	Ref. No.	N/A
description	manometer thread 1/4" pressure range 0 up to 3bar red marking 1 connection on the backside		



1

Part No.	541239	Ref. No.	N/A
description	manometer thread 1/4" pressure range 0 up to 18bar black marking 9		



1

Part No.	541238	Ref. No.	N/A
description	manometer thread 1/4" pressure range 0 up to 18bar red marking 1		



1

Part No.	541240	Ref. No.	N/A
description	manometer thread 1/8" pressure range 0 up to 16bar black marking 8 connection horizontal		



1

Part No.	541241	Ref. No.	N/A
description	manometer thread 1/8" pressure range 0 up to 3bar black marking 1-1.25 connection on the backside angled		

dosing pumps

membrane dosing pumps

self-priming

SEKO

spare parts



1

Part No.	361304	Ref. No.	WGADM0041/053
description	O-ring EPDM ID ø 11.11mm thickness 1.78mm Qty 1 pcs for type DIB3E/DIB5E		

self-priming with supporting pressure

SEKO



1

Part No.	361304	Ref. No.	WGADM0041/053
description	O-ring EPDM ID ø 11.11mm thickness 1.78mm Qty 1 pcs for type DIB3E/DIB5E		



fittings, hose and pipe connectors

hose connectors

without screw connection



1

Part No.	526673	Ref. No.	WGA5001021000
description	hose connector plastic hose ø 15-15mm angled L 48mm W 48mm		

valves and tank inlets

ball valves

universal

mini ball valves



1

Part No.	520722	Ref. No.	WGA5001016000
description	ball valve connection 1/4" IT - 1/4" ET DN8 total length 39mm chrome-plated brass		

ancillary products

clamps

one ear clamps



1

Part No.	520752	Ref. No.	12000892
description	one ear clamp ø 7.8-9.5mm width 5mm strip thickness 0.6mm Qty 20 pcs SS W4		

fastening material

screws

countersunk screws



1

Part No.	560077	Ref. No.	DI7987-5x8 I
description	countersunk screw thread M5 L 10mm SS DIN 963/ISO 2009 Qty 20 pcs intake slotted head ø 9.2mm		

fasteners

clamps

one ear clamps



1

Part No.	520752	Ref. No.	12000892
description	one ear clamp ø 7.8-9.5mm width 5mm strip thickness 0.6mm Qty 20 pcs SS W4		

GASTROPARTS.COM

