



GASTROPARTS

Frymaster

- [EN]** Equipment
- [DE]** Geräte
- [ES]** Aparatos
- [FR]** Équipement
- [IT]** Attrezzature
- [PL]** Urządzenia
- [RU]** Оборудование

✉ gastroparts@gastroparts.com

☎ +48 56 657 00 66

📘 fb.com/gastroparts.global

GASTROPARTS.COM





heating elements

heating elements for fryers

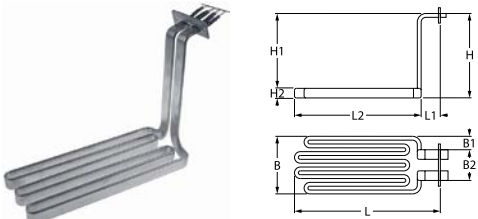

Part No.	417623	Ref. No.	44-8262155 807-2645 826-2155
description	heating element 8500W 240V L 400mm W 145mm H 300mm flange connection plug heating circuits 3 fryer heaters L1 352mm L2 30mm H1 255mm H2 25mm hole distance 85mm hole ø 6mm flange length 101mm flange width 35mm cable length 1000mm		

heating elements for heated cabinets



Part No.	419006	Ref. No.	8070748
description	heating element 825W 208/240V heating circuits 1 L 517mm connection snap-on connection tube ø 11mm for chafing dish		

thermostats

control and safety thermostats

INVENSYS / ROBERTSHAW

control thermostats



Part No.	376042	Ref. No.	8262014
description	thermostat t.max. 191°C 1-pole 1NOA probe ø 8mm probe L 124mm capillary pipe 590mm capillary pipe isolatedmm gland nut shaft ø 6.3x4.7mm shaft L 24mm shaft position upper operating temperature range 375°F		



Part No.	390636	Ref. No.	807-3515
description	thermostat t.max. 204°C temperature range 93-204°C 1-pole 1NO 0.67A probe ø 9.5mm probe L 123mm capillary pipe 915mm capillary pipe isolatedmm gland nut 1/4" NPT shaft ø 6x4.6mm shaft L 21mm shaft position lower rotation 315° probe material nickel-plated probe thread 1/4" US		

various

control thermostats

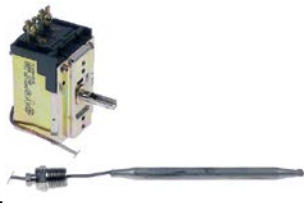

Part No.	580023	Ref. No.	807-1147 807-1692 8262013
description	thermostat temperature range 94-190°C 1-pole probe ø 8mm probe L 120mm capillary pipe 600mm gland nut 1/4" shaft ø 6x4.6mm shaft L 16mm		

safety thermostats

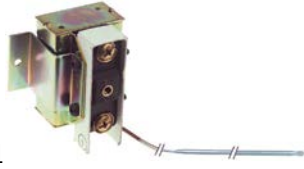

Part No.	580022	Ref. No.	807-0063 8071070 8261001
description	safety thermostat		

accessories

axis extensions



Part No.	580030	Ref. No.	810-0202
description	shaft extension		



1

Part No.	580028	Ref. No.	810-0199 810-0345
description	shaft extension flexible for thermostat		

miscellaneous



1

Part No.	580026	Ref. No.	806-0087 806-0087SP 820-0015
description	bezel for thermostat		

switches and momentary switches

rocker/momentary rocker switches

37x21mm



1

Part No.	348095	Ref. No.	2026 8073580
description	rocker switch mounting measurements 37x21mm black 1NO 250V 20A connection male faston 6.3mm ambient temperature max. 125°C protection IP40		



1

Part No.	347969	Ref. No.	8074036
description	rocker switch mounting measurements 37x21mm black 2NO 250V 10A 0-1 connection male faston 6.3mm ambient temperature max. 85°C protection IP44		

contactors

HARTLAND

power contactors



1

Part No.	381283	Ref. No.	810-1202
description	power contactor resistive load 40A 24VAC 30A/10HP (AC3/240V) 30A/7.46kW main contacts 3NO auxiliary contacts connection screw clamp/male faston 6.3mm type HCCY3XQ02CY		



1

Part No.	381277	Ref. No.	807-2284 8263417
description	power contactor resistive load 50A 24VAC 40A/10HP (AC3/240V) 40A/7.46kW main contacts 3NO auxiliary contacts connection screw clamp/male faston 6.3mm type HCCY3XQ04CG		

transformers

open transformers

with plug connection

1

Part No.	403944	Ref. No.	807-1999 807-5129
description	transformer primary 208/220/230/240VAC secondary 12/24VAC H 65mm L 65mm W 130mm connection male faston 4.8mm 50/60Hz		



probes

producer-specific probes

probes



Part No.	379819	Ref. No.	807-2478 8261526
description	probe PTC 1k0hm cable PVC probe -50 up to +150°C cable -10 up to 100°C connection 2-wire thread probe ø5x280mm cable length 0.6m		

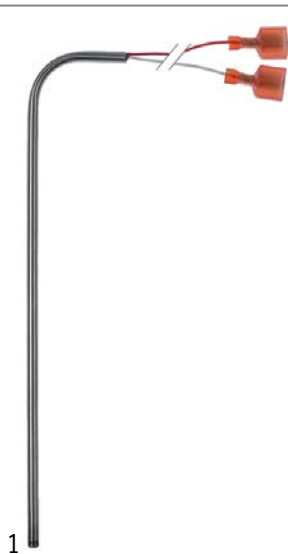

Part No.	403771	Ref. No.	8064764
description	temperature probe Pt1000 cable PTFE probe -40 up to +250°C connection F6.3 thread probe 5x205mm cable length 0.14m		

electronics

PCBs



Part No.	402936	Ref. No.	8262256
description	PCB for fryer H14/H17/H22 L 125mm W 110mm		

gas valves and ignition boxes

gas control valves

HONEYWELL

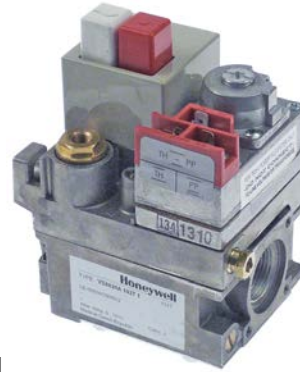



Part No.	107362	Ref. No.	8072122
description	gas valve type VS8820A natural gas 0.75VHz gas inlet 3/4" NPT gas outlet 3/4" NPT thermocouple connection ASA 11/32 pilot connection 1/4" CCT pressure range 2.5-20mbar operator type VS824A HONEYWELL		

ROBERTSHAW

electric controlled valves







Part No.	101429	Ref. No.	806-1452 806-1452SP 807-0308
description	gas valve 120V 50/60Hz gas inlet 3/4" gas outlet 3/4" thermocouple connection 3/8" NEF pilot connection 1/4" pipe US type 7000BMSER-120 pressure controller natural gas 3.5" W.C. suitable for ROBERTSHAW		
spare parts for	101429		
	Part No.	101047	Ref. No. —
	magnet unit T1: ASA 11/32 T2: M24x1 L 59mm ø 4mm suitable for ROBERTSHAW		
	Part No.	101389	Ref. No. —
	pressure controller natural gas suitable for ROBERTSHAW		
	Part No.	580033	Ref. No. 810-0109 810-0433
	knob suitable for ROBERTSHAW		
accessories for	101429		
	Part No.	580035	Ref. No. 810-0162
	thermopile L 36" - 915mm probe ø 9mm probe L 38mm 250-750mV screw connection 7/16" connection 3/8" NEF		

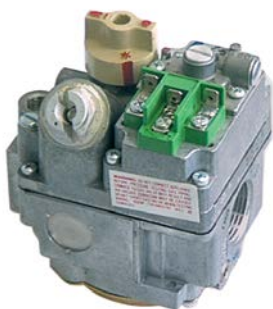



gas controlled valves







1			
Part No.	580032	Ref. No.	807-0428
description	gas valve 50/60Hz gas inlet 1/2" gas outlet 1/2" thermocouple connection 3/8" NEF pilot connection 1/4" pipe US type 7000BMSER pressure controller natural gas 3.5" W.C. suitable for ROBERTSHAW supply 24VAC supply 12VDC		
spare parts for	580032		
	Part No.	101047	Ref. No. —
	magnet unit T1: ASA 11/32 T2: M24x1 L 59mm ø 4mm suitable for ROBERTSHAW		
	Part No.	101389	Ref. No. —
	pressure controller natural gas suitable for ROBERTSHAW		
	Part No.	101403	Ref. No. —
	operator 24V voltage AC natural gas suitable for ROBERTSHAW		
	Part No.	580033	Ref. No. 810-0109 810-0433
	knob suitable for ROBERTSHAW		
accessories for	580032		
	Part No.	580035	Ref. No. 810-0162
	thermopile L 36" - 915mm probe ø 9mm probe L 38mm 250-750mV screw connection 7/16" connection 3/8" NEF		

millivolt controlled valves



1			
Part No.	106122	Ref. No.	8070115 8072427
description	gas valve supply Operator millivolt gas inlet 1/2" NPT gas outlet 1/2" NPT thermocouple connection pilot connection 1/4" CCT type 7000BMVR pressure controller natural gas 4.0" W.C.		
spare parts for	106122		
	Part No.	101422	Ref. No. —
	operator natural gas supply Operator millivolt		
	Part No.	106109	Ref. No. —
	locking screw thread 7/16"-24 UNS for pipe ø 1/4" L 16mm brass Qty 1 pcs WS 7/16" (11.113mm) hole ø 6.4mm		

spare parts for	106122		
	Part No.	580033	Ref. No. 810-0109 810-0433
	knob suitable for ROBERTSHAW		

1			
Part No.	580031	Ref. No.	807-0115 807-0306 807-2427 807-2428 810-0014
description	gas valve supply Operator millivolt gas inlet 3/4" NPT gas outlet 3/4" NPT thermocouple connection pilot connection 1/4" CCT type 7000BMVR pressure controller natural gas 3.5" W.C. suitable for ROBERTSHAW		
spare parts for	580031		
	Part No.	101422	Ref. No. —
	operator natural gas supply Operator millivolt		
	Part No.	106109	Ref. No. —
	locking screw thread 7/16"-24 UNS for pipe ø 1/4" L 16mm brass Qty 1 pcs WS 7/16" (11.113mm) hole ø 6.4mm		
	Part No.	106121	Ref. No. —
	pressure controller natural gas 3.5" W.C.		
	Part No.	580033	Ref. No. 810-0109 810-0433
	knob suitable for ROBERTSHAW		



ignition parts

pilot burners

ROBERTSHAW

pilot burners

universal series - type 6

Width of caps:

6CH10 = 1" (25,4mm)

6CH14 = 1½" (38,1mm)

6CH24 = 2½" (63,5mm)

6CH30 = 3" (76,2mm)



1

Part No.	107394	Ref. No.	8102032
description	pilot burner ROBERTSHAW type 6CH14-2 3 flames natural gas code 26 for pipe ø 1/4" CCT		
spare parts for	107394		
	Part No.	100277	Ref. No. —
	pilot burner nozzle natural gas code 26 suitable for ROBERTSHAW		

HONEYWELL

pilot burners



1

Part No.	107397	Ref. No.	8071707
description	pilot burner type Q348AC1 1144 3 flames natural gas nozzle NE22 1/4"		

WHITE ROGERS



1

Part No.	107419	Ref. No.	8100156 8100157
description	pilot burner type 262A38 0407 2 flames natural gas 1/4" nozzle TL020		



1

Part No.	107393	Ref. No.	8100426
description	pilot burner type 262A38 1112 2 flames natural gas 1/4"		



1

Part No.	107392	Ref. No.	8100427
description	pilot burner type 262A38 1310 2 flames LPG 1/4"		



1



Part No.	107366	Ref. No.	8121286
description	pilot burner type 262A38 2 flames natural gas 1/4"		

piezoelectric igniters

mounting diameter 18mm



1

Part No.	100009	Ref. No.	810-1001
description	piezoelectric igniter body plastic blowing mounting ø 18mm connection ø2.4mm front measurements 26mm M18x1.5		
accessories for	100009		
	Part No.	101339	Ref. No. —
	cover cap for piezoelectric igniter		
	Part No.	106869	Ref. No. —
	cover cap for piezoelectric igniter ID ø 22mm ED ø 35mm H 25mm		
	Part No.	107931	Ref. No. —
	cover cap for piezoelectric igniter ID ø 21mm ED ø 36mm		



thermocouples

plug-in thermocouples

plug-in thermocouples with interruption

1

Part No.	103349	Ref. No.	8103442
description	thermocouple WHITE RODGERS with interrupter L 750mm male faston 6.3mm 7/16" gas connection 11/32"		

thermopiles

1

Part No.	580035	Ref. No.	810-0162
description	thermopile L 36" - 915mm probe \varnothing 9mm probe L 38mm 250-750mV screw connection 7/16" connection 3/8" NEF		

1

Part No.	103362	Ref. No.	810-06171 810-1873
description	thermopile WHITE RODGERS L 900mm probe \varnothing 11.5mm probe L 46mm screw connection connection male faston 6.3mm		

1

Part No.	103243	Ref. No.	6717038 807-3485
description	thermopile with PG9 adapter WHITE RODGERS L 36" - 915mm probe \varnothing 9mm probe L 40mm 250-750mV screw connection 7/16" connection spate terminals		

accessories

interrupters

1

Part No.	580046	Ref. No.	807-0280
description	extension for interruptor L 18" - 455mm		

gas nozzles

main nozzles

gas nozzles 1/8" NPT

1

Part No.	102559	Ref. No.	610-0140 810-0140 826-1352
description	gas injector thread 1/8" NPT WS 13 code 67		

1

Part No.	103256	Ref. No.	8100129 826-1353
description	gas injector thread 1/8" WS 13 bore \varnothing 1.7mm brass code 1.7		

gas nozzles (other)

1

Part No.	103134	Ref. No.	812-1028
description	gas injector T1: 9/16" UNEF T2: 1/8" NPT WS 16 bore \varnothing 2.2mm L 51mm		

pilot burner nozzles

pilot burner nozzles ROBERTSHAW

1

Part No.	100275	Ref. No.	810-0125
description	pilot burner nozzle LPG code 10 bore \varnothing 0.1mm suitable for ROBERTSHAW		



			
1			
Part No.	100276	Ref. No.	810-0126
description	pilot burner nozzle natural gas code 18 suitable for ROBERTSHAW		

equipment-specific units

for deep fryers

miscellaneous

			
1			
Part No.	580026	Ref. No.	806-0087 806-0087SP 820-0015
description	bezel for thermostat		

			
1			
Part No.	580030	Ref. No.	810-0202
description	shaft extension		

			
1			
Part No.	580028	Ref. No.	810-0199 810-0345
description	shaft extension flexible for thermostat		

filters

deep fryer filters

			
1			
Part No.	970749	Ref. No.	6716985 803-0170
description	oil filter W 500mm L 706mm for fryer paper 100pcs		

baskets

fryer baskets

US producers

			
1			
Part No.	970134	Ref. No.	803-0019
description	fryer basket L1 280mm W1 140mm H1 105mm		

			
1			
Part No.	970183	Ref. No.	803-0022 803-0271 803-0307
description	fryer basket L1 308mm W1 160mm H1 135mm		



Part No.	970911	Ref. No.	803-0099
description	fryer basket W1 312mm L1 325mm H1 130mm		

GASTROPARTS.COM

