



GASTROPARTS

FriFri

- [EN]** Equipment
- [DE]** Geräte
- [ES]** Aparatos
- [FR]** Équipement
- [IT]** Attrezzature
- [PL]** Urządzenia
- [RU]** Оборудование

✉ gastroparts@gastroparts.com

☎ +48 56 657 00 66

📘 fb.com/gastroparts.global

GASTROPARTS.COM





heating elements

heating elements for chip scuttles

			
Part No.	418465	Ref. No.	1G592028
description	heating element 800W 230V heating circuits 1 L 370mm W 95mm connection male faston 6.3mm tube \varnothing 6.3mm dry heating element connection distance 89mm		
For models:	SILOFRIT-ASF1, SILOFRIT-BSF1		

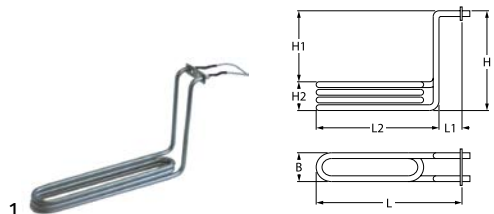
			
Part No.	415738	Ref. No.	09-09 400361 400533
description	heating element 2000W 230V heating circuits 1 L 302mm W 51mm H 177mm L1 15mm L2 285mm H1 152mm H2 25mm windings 3 flange length 56mm flange width 18mm hole distance 18mm hole \varnothing 4.9mm cable length 330mm tube \varnothing 8.5mm rectangular flange fryer heaters		
For models:	D8		

heating elements for fryers

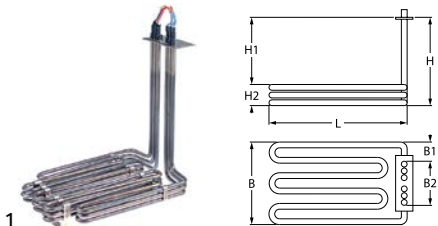
			
Part No.	416426	Ref. No.	300950 300950 (10-09)
description	heating element 11400W 230/400V heating circuits 3 L 310mm W 215mm H 298mm rectangular flange immersion heater W1 66mm W2 60mm H1 260mm H2 32mm hole distance 95mm hole \varnothing 6mm flange length 106mm flange width 52mm cable length 70mm tube \varnothing 8.5mm connection length 33mm		
For models:	FFE31, FFM31, FFS31, FFS41		

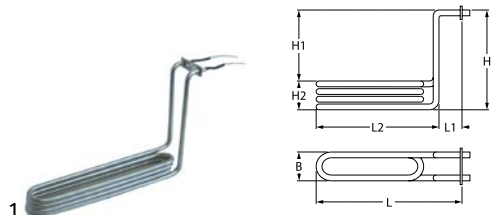
			
Part No.	415739	Ref. No.	09-10 400362 400534
description	heating element 3000W 230V heating circuits 1 L 298mm W 51mm H 190mm L1 18mm L2 280mm H1 150mm H2 40mm windings 4 flange length 57mm flange width 18mm hole distance 18mm hole \varnothing 4mm cable length 250mm connection length 45mm tube \varnothing 8.5mm rectangular flange fryer heaters		
For models:	D4		

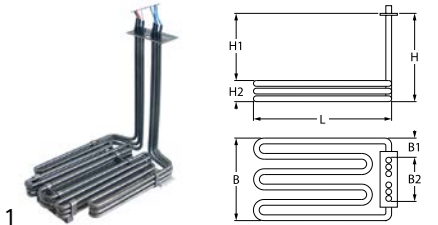
			
Part No.	416425	Ref. No.	100744
description	heating element 11400W 230V heating circuits 3		

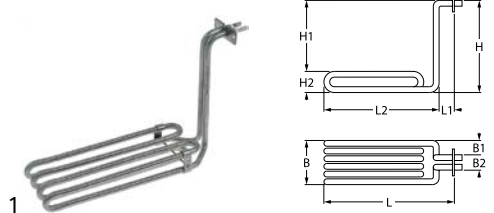
			
Part No.	415742	Ref. No.	100947
description	heating element 2300W 230V heating circuits 1 L 280mm W 90mm H 180mm L1 25mm L2 257mm W1 35mm W2 20mm H1 150mm H2 30mm windings 4 flange length 50mm flange width 20mm hole distance 40mm hole \varnothing 5mm connection male faston 6.3mm tube \varnothing 8.5mm rectangular flange fryer heaters		
For models:	FT10, FT4, FT4+4, FT6, FT8, PROFI10, PROFI6, PROFI6+6, PROFI8, PROFI8+8		

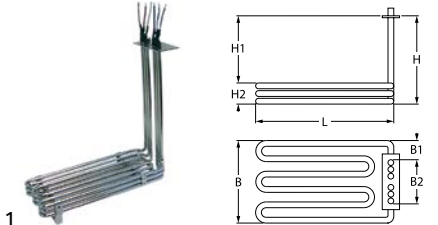
			
Part No.	415741	Ref. No.	100299 101105 12-01 600644
description	heating element 7500W 230/400V heating circuits 3 L 310mm W 130mm H 295mm rectangular flange connection cable fryer heaters W1 26mm W2 78mm H1 261mm H2 34mm hole distance 95mm hole \varnothing 6mm flange length 105mm flange width 52mm cable length 70mm tube \varnothing 8.5mm		
For models:	FF21, FF41, FF42, FFE21, FFE41, FFE41TWIN, FFE42, FFM21, FFM41, FFM41TWIN, FFM42, FFS21, FFS41, FFS42		



Part No.	416424	Ref. No.	300915
description	heating element 3200W 230V heating circuits 1 L 297mm W 180mm H 161mm L1 28mm L2 269mm W1 81mm W2 18mm flange length 47mm flange width 25mm hole distance 34mm windings 3 tube \varnothing 8mm connection length 29mm connection male faston 6.3mm hole \varnothing 4mm rectangular flange immersion heater		
For models:	ECO6, ECO6+6		

Part No.	415719	Ref. No.	09-26
description	heating element 3200W 230V heating circuits 1 L 290mm W 179mm H 148mm rectangular flange connection male faston 6.3mm fryer heaters L1 12mm L2 68mm L3 210mm W1 80mm W2 19mm hole distance 34mm windings 4 hole \varnothing 4mm flange length 47mm flange width 24mm		

Part No.	416423	Ref. No.	300914
description	heating element 3200W 230V heating circuits 1 L 295mm W 127mm H 162mm rectangular flange connection male faston 6.3mm fryer heaters L1 25mm L2 20mm L3 250mm W1 55mm W2 18mm hole distance 34mm windings 3 hole \varnothing 4.5mm flange length 46mm flange width 25mm tube \varnothing 7mm connection length 30mm		
For models:	ECO4, ECO4+4		

Part No.	415743	Ref. No.	09-05 21550015
description	heating element 3750W 230/400V heating circuits 3 L 284mm W 203mm H 164mm L1 19mm L2 265mm W1 55mm W2 75mm H1 140mm H2 24mm windings 9 flange length 65mm flange width 24mm hole distance 29mm hole \varnothing 5mm connection cable cable length 100mm rectangular flange fryer heaters		

heating elements for salamanders/toast-

Part No.	419023	Ref. No.	300563
description	heating element 400W 230V heating circuits 1 L 405mm tube \varnothing 8.5mm dry heating element salamander/pizza oven		
For models:	DUOFOUR, SALAMANDER		

quartz heating elements

1			
Part No.	550346	Ref. No.	25-07, 400.003
description	insulator ceramic for quartz heating element L 15mm \varnothing 9mm		

1			
Part No.	415301	Ref. No.	13-01 23050001
description	quartz heating element 190W 230V L 450mm \varnothing 10mm connection plug-in connection		

1			
Part No.	415309	Ref. No.	12050000 14-01
description	quartz heating element 400W 230V L 340mm \varnothing 10mm connection plug-in connection		

1			
Part No.	415302	Ref. No.	14-04 400595 600005
description	quartz heating element 400W 230V L 420mm \varnothing 10mm connection plug-in connection		
For models:	DUOFOUR, SALAMANDER		

1			
Part No.	415313	Ref. No.	14-03 25550001
description	quartz heating element 420W 230V L 460mm \varnothing 10mm connection plug-in connection		



foil heating elements

 <p>1</p>			
Part No.	418472	Ref. No.	1G962947
description	foil heating element L 400mm W 230mm 175W 230V aluminium cable length 490mm thickness 3mm		
For models:	SILOFRIT-ASF1, SILOFRIT-BSF1		

accessories

 <p>1</p>			
Part No.	550345	Ref. No.	25-06, 230.59.005
description	spring angled for socket		

 <p>1</p>			
Part No.	550346	Ref. No.	25-07, 400.003
description	insulator ceramic for quartz heating element L 15mm ø 9mm		

thermostats

control and safety thermostats

<p>EGO</p> <p>control thermostats</p> <p>55.13_ series</p>  <p>1</p>			
Part No.	375683	Ref. No.	400374
description	thermostat t.max. 175°C temperature range 95-175°C 1-pole 1NO 16A probe ø 4mm probe L 157mm capillary pipe 670mm capillary pipe isolated 350mm gland nut shaft ø 6x4.6mm shaft L 23mm shaft position upper rotation 270°		
For models:	D4		

 <p>1</p>			
Part No.	375224	Ref. No.	400772 601034
description	thermostat t.max. 184°C temperature range 35-184°C 1-pole 1NO 16A probe ø 3mm probe L 165mm capillary pipe 520mm capillary pipe isolated 270mm gland nut shaft ø 6x4.6mm shaft L 20mm shaft position upper rotation 270° probe material SS		
For models:	ECO4, ECO4+4, ECO6, ECO6+6		



E·G·O



Part No.	375677	Ref. No.	400541
description	thermostat t.max. 195°C temperature range 103-195°C 1-pole 1NO 16A probe ø 4mm probe L 157mm capillary pipe 2250mm capillary pipe isolated 2020mm gland nut shaft L 18mm shaft position upper rotation 270°		
For models:	FF21, FF31, FF41, FF42, FFS21, FFS31, FFS41, FFS42		

E·G·O



Part No.	375512	Ref. No.	400370
description	thermostat t.max. 185°C temperature range 95-185°C 3-pole 3NO 16A probe ø 6mm probe L 133mm capillary pipe 2430mm capillary pipe isolated 1100mm gland nut M9x1 shaft ø 6x4.6mm shaft L 23mm shaft position upper rotation 270°		
For models:	D6, D8		

E·G·O

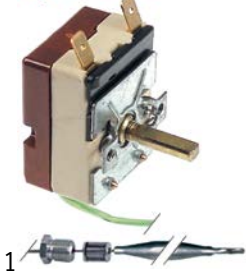

Part No.	375527	Ref. No.	100374
description	thermostat t.max. 200°C temperature range 60-200°C 1-pole 1NO 16A probe ø 6mm probe L 77mm capillary pipe 870mm capillary pipe isolatedmm gland nut M9x1 shaft L 23mm shaft position upper rotation 270°		

E·G·O

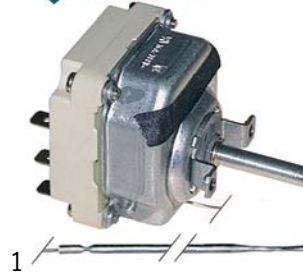

Part No.	375050	Ref. No.	100374
description	thermostat t.max. 200°C temperature range 60-200°C 3-pole 3NO 16A probe ø 3.1mm probe L 235mm capillary pipe 1480mm capillary pipe isolatedmm gland nut shaft L 23mm shaft position upper rotation 270°		

55.34_ series

E·G·O

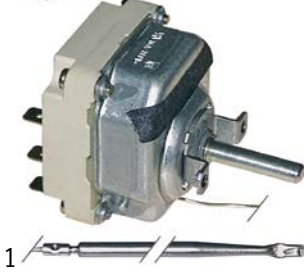

Part No.	375256	Ref. No.	400369
description	thermostat t.max. 175°C temperature range 100-175°C 3-pole 3NO 16A probe ø 4mm probe L 157mm capillary pipe 850mm capillary pipe isolated 350mm gland nut shaft ø 6x4.6mm shaft L 23mm shaft position upper rotation 270°		
For models:	D6, D8		

E·G·O



Part No.	375043	Ref. No.	09580111
description	thermostat t.max. 200°C temperature range 65-200°C 3-pole 3NO 16A probe ø 6mm probe L 77mm capillary pipe 880mm capillary pipe isolated 800mm gland nut M9x1 shaft ø 6x4.6mm shaft L 23mm shaft position upper rotation 270°		



safety thermostats

55.13_ series



Part No.	390817	Ref. No.	09580134
description	safety thermostat switch-off temp. 250°C 1-pole probe ø 6mm probe L 78mm capillary pipe 900mm capillary pipe isolatedmm gland nut probe		
For models:	OPTIMA-E20, OPTIMA-E22, OPTIMA-E30, OPTIMA-E32, OPTIMA-E40, OPTIMA-E42, OPTIMA-E47, OPTIMA-E48, OPTIMA-EE20, OPTIMA-EE22, OPTIMA-EE30, OPTIMA-EE32, OPTIMA-EE40, OPTIMA-EE42, OPTIMA-EE47, OPTIMA-EE48		



Part No.	375678	Ref. No.	400375
description	safety thermostat switch-off temp. 290°C 1-pole 16A probe ø 4mm probe L 111mm capillary pipe 710mm capillary pipe isolated 450mm gland nut probe SS		
For models:	D4		

55.31_ series



Part No.	375127	Ref. No.	02-02 400189
description	safety thermostat switch-off temp. 290°C 3-pole 20A probe ø 6mm probe L 220mm capillary pipe 840mm capillary pipe isolatedmm gland nut probe		



Part No.	375679	Ref. No.	400364
description	safety thermostat switch-off temp. 295°C 3-pole 20A probe ø 4mm probe L 157mm capillary pipe 670mm capillary pipe isolated 350mm gland nut probe SS		
For models:	D6, D8		

56_ series



Part No.	375442	Ref. No.	601275
description	safety thermostat capillary pipe 1760mm probe ø 4mm 1-pole probe L 100mm 16A capillary pipe isolated 1600mm gland nut switch-off temp. 320°C probe		

CAEM

safety thermostats



Part No.	375899	Ref. No.	600381
description	safety thermostat switch-off temp. 222°C 1-pole 16A probe ø 3mm probe L 160mm capillary pipe 900mm capillary pipe isolated 190mm gland nut probe material SS replace set		

JAEGER

safety thermostats





Part No.	375244	Ref. No.	600709
description	safety thermostat		
For models:	ECO4, ECO4+4, ECO6, ECO6+6		



			
1			
Part No.	375248	Ref. No.	600707
description	safety thermostat switch-off temp. 295°C 16A probe ø 3mm probe L 138mm capillary pipe 610mm capillary pipe isolated 440mm screw mounting complete auxiliary equipment		
For models:	FT10, FT4, FT4+4, FT6, FT8		

various
safety thermostats



			
1			
Part No.	375682	Ref. No.	400537 400674 400676 600383
description	safety thermostat switch-off temp. 285°C 1-pole		
For models:	FF21, FF31, FF41, FF42		

			
1			
Part No.	375249	Ref. No.	600711
description	safety thermostat switch-off temp. 305°C probe ø 3mm probe L 140mm capillary pipe 2270mm screw mounting		
For models:	FFS21, FFS31, FFS41, FFS42		

switches and momentary switches

rocker/momentary rocker switches

30x11mm			
			
1			
Part No.	301012	Ref. No.	400553
description	rocker switch mounting measurements 30x11mm green 1NO/ indicator light 250V 16A 0-I connection male faston 6.3mm ambient temperature max. 85/125°C protection IP40		
For models:	DUOFOUR		

30x22mm			
			
1			
Part No.	301003	Ref. No.	400627
description	rocker switch mounting measurements 30x22mm green 2NO 250V 16A illuminated 0-I connection male faston 6.3mm ambient temperature max. 125/55°C protection IP65		
For models:	DUOFOUR, FF21, FF31, FF41, FF42, FT10, FT4, FT4+4, FT6, FT8, SALAMANDER		
accessories for	301003		
	Part No.	301036	Ref. No. 400647
	protective cover internal size 30x22mm for rocker switch mounting measurementsmm		

			
1			
Part No.	301036	Ref. No.	400647
description	protective cover internal size 30x22mm for rocker switch mounting measurementsmm		
For models:	FF21, FF31, FF41, FF42, FT10, FT4, FT4+4, FT6, FT8		

push/momentary push switches

30x22mm			
			
1			
Part No.	301036	Ref. No.	400647
description	protective cover internal size 30x22mm for rocker switch mounting measurementsmm		
For models:	FF21, FF31, FF41, FF42, FT10, FT4, FT4+4, FT6, FT8		

microswitches

pin-plunger actuated

			
1			
Part No.	345060	Ref. No.	400547
description	microswitch with plunger 250V 16A 1NO connection male faston 6.3mm ambient temperature max. 85°C mounting distance 22mm type BS1010 actuating force: 350g red stroke 9mm		
For models:	ECO4, ECO4+4, ECO6, ECO6+6, FF21, FF31, FF41, FF42, FT10, FT4, FT4+4, FT6, FT8, PROF10, PROF16, PROF16+6, PROF18, PROF18+8		

			
1			
Part No.	300092	Ref. No.	400358
description	microswitch with plunger 400V 16A 2NO connection male faston 6.3mm ambient temperature max. 85°C mounting distance 22mm type XTD22A21 actuating force: 150g fryer black		

non-standard

			
1			
Part No.	345126	Ref. No.	03-21 400358
description	microswitch with plunger 2NO connection male faston 6.3mm		
For models:	D4		



cam switches

on/off



1			
Part No.	300074	Ref. No.	1G960702
description	cam switch 4 operating positions 2NO sequence 0-1-0-1 16A shaft \varnothing 6x4.6mm shaft L 23mm connection male faston 6.3mm ceramic		
For models:	SILOFRIT-ASF1, SILOFRIT-BSF1		

operation switches



1			
Part No.	300002	Ref. No.	400371
description	cam switch 2 operating positions 4NO 16A sequence 0-1 shaft \varnothing 6x4.6mm shaft L 23mm connection male faston 6.3mm ceramic		
For models:	D6, D8		



1			
Part No.	300080	Ref. No.	21558010
description	cam switch 2 operating positions 4NO 16A sequence 0-1 shaft \varnothing 6x4.6mm shaft L 23mm connection screw operation switch ceramic ambient temperature max. 150°C		
accessories for	300080		
		Part No.	551456
		Ref. No.	—
	gasket for switch ED \varnothing 14mm ID \varnothing 2.5mm thickness 3.5mm white		



1			
Part No.	300200	Ref. No.	400372
description	operation switch 2 operating positions 2NO 16A sequence 0-1 shaft \varnothing 6x4.6mm shaft L 23mm connection male faston 6.3mm operation switch ceramic		
For models:	D4		

magnetic switches

29x19mm

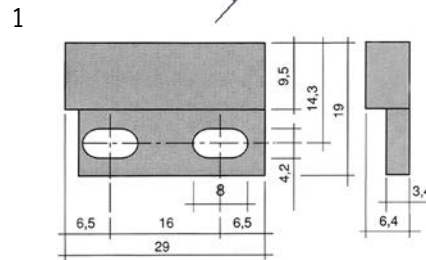

1			
Part No.	345808	Ref. No.	101418 400906
description	magnetic switch L 29mm W 19mm 1CO 150V 0.5A P max. 10W connection cable cable length 1000mm		
For models:	FFE21, FFE31, FFE41, FFE41TWIN, FFE42, FFM21, FFM31, FFM41, FFM41TWIN, FFM42, FFS21, FFS31, FFS41, FFS42		

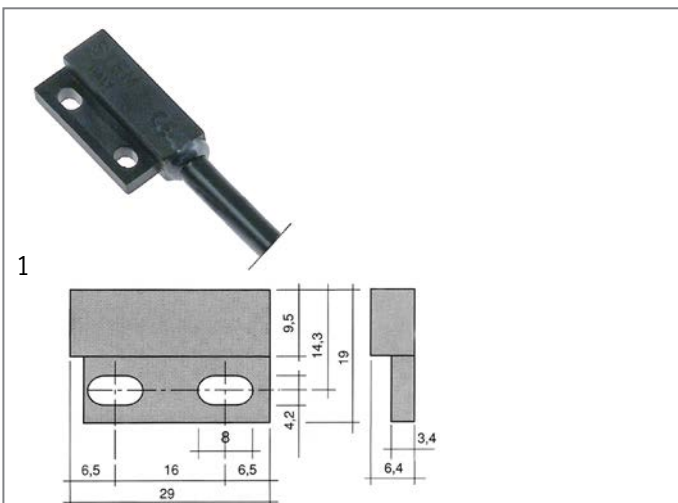

Part No.	345217	Ref. No.	400857
description	magnetic switch L 29mm W 19mm 1NO 125V 0.5A P max. 10W connection cable cable length 2000mm		
For models:	FFE21, FFE31, FFE41, FFE42, FFM31, FFM41, FFM42, FFS21, FFS41, FFS42		

encoders and potentiometers



Part No.	400849	Ref. No.	101336
description	encoder KOhm rotation 360° shaft ø 5.9mm shaft L 214mm for fryer thread M10 plug type male faston cable length 300mm		
For models:	FFS21, FFS31, FFS41, FFS42		

lamps

indicator lights

indicator lights (complete)

ø10mm

with plug-in socket



Part No.	359230	Ref. No.	400543
description	indicator light ø 10mm green 230V connection male faston 2.8mm Qty 1 pcs		
For models:	FF21, FF31, FF41, FF42, FFS18G, FFS21, FFS25G, FFS31, FFS41, FFS42, SIMPLY-S18, SIMPLY-S25		



Part No.	359231	Ref. No.	400544
description	indicator light ø 10mm yellow 230V connection male faston 2.8mm Qty 1 pcs		
For models:	FF21, FF31, FF41, FF42, FFS18G, FFS21, FFS25G, FFS31, FFS41, FFS42, SIMPLY-S18, SIMPLY-S25		



Part No.	359258	Ref. No.	400771
description	indicator light ø 10mm 230V yellow		
For models:	ECO4, ECO4+4, ECO6, ECO6+6		

30x22mm





Part No.	359156	Ref. No.	400698
description	indicator light mounting measurements 30x22mm 230V yellow connection male faston 6.3mm temp.-resist. 125/55°C type RL2		
For models:	FT10, FT4, FT4+4, FT6, FT8		

timers

mechanical timers



Part No.	350049	Ref. No.	400765	
description	timer M2 with bell 2-pole operation time 30min impulse mechanical 2NO at 250V 16A permanent position yes shaft ø 6x4.6mm shaft 6x4.6mm shaft L 23mm mounting distance 28mm connection lateral			
For models:	DUOFOUR, SALAMANDER			
accessories for	350049			
	Part No.	110366	Ref. No.	—
	knob switch zero mark t.max.°C ø 44mm shaft ø 6x4.6mm shaft flat upper black			
	Part No.	111205	Ref. No.	—
	dial plate graduation 30min permanent position yes rotation 30-300° ø 60mm			

contactors

GENERAL ELECTRIC (AEG)

power contactors



Part No.	380239	Ref. No.	400796
description	power contactor resistive load 20A 230VAC (AC3/400V) 8.4A/4kW main contacts 3NO auxiliary contacts 1NC connection screw connection type LS05 01A type AEG LS05 01A type GE MC1A 301A		
For models:	FFE21, FFE42, FFM42, FFS21, FFS42, FT10, FT6, FT8		

1

Part No.	380238	Ref. No.	400796
description	power contactor resistive load 20A 230VAC (AC3/400V) 8.4A/4kW main contacts 3NO auxiliary contacts 1NO connection screw connection type LS0510A type AEG LS0510A type GE MC1A 310A		



1

Part No.	380261	Ref. No.	400797
description	power contactor resistive load 32A 230VAC (AC3/400V) 17A/7.5kW main contacts 3NO auxiliary contacts 1NO connection screw connection type AEG LS7K 10A type GE CL02A 310		
For models:	FF31, FFE21, FFE31, FFE41, FFE41TWIN, FFE42, FFM21, FFM31, FFM41, FFM41TWIN, FFS21, FFS31, FFS41, FFS42		

relays

power relays

with DIN rail mounting

lateral

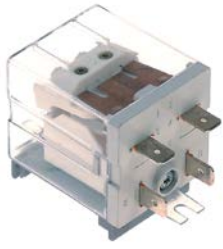

1

Part No.	380376	Ref. No.	400798
description	power relays FINDER 230VAC 30A 1NO connection male faston 6.3mm DIN rail manuf. no. 65.31		
For models:	FFE21, FFE31, FFE41, FFE42, FFM31, FFM41, FFM42, FFS21, FFS31, FFS41, FFS42		

with bracket mounting



1

Part No.	380185	Ref. No.	400559
description	power relays Italiana Relè 230VAC 30A 1NO connection F6.3 bracket mounting dimensions 36.5x32.2x51.8mm manuf. no. A10-230AC-FA		
For models:	FF21, FF31, FF41, FF42		

with special fixing



1

Part No.	380186	Ref. No.	04-06 400640
description	power relays 3NO		
For models:	FT6, FT8		

with male contacts

bullet connectors, 8 contacts



1

Part No.	380134	Ref. No.	400540	
description	power relays Italiana Relè 230VAC 10A 2CO connection plug-in connection round 8-pole manuf. no. C42-230VAC 90.26/ZVE8 250V			
For models:	FF21, FF41, FF42			
accessories for	380134			
	Part No.	380137	Ref. No.	—
	relay socket 8-pole connection plug-in connection round 8-pole dimensions 65x28x40mm 380V voltage AC 10A Italiana Relè manuf. no. ZVE8			
	Part No.	380638	Ref. No.	—
	relay socket 8-pole dimensions 51x41x23mm 250V 10A FINDER manuf. no. 90.26			



probes

producer-specific probes

probes

			
Part No.	378311	Ref. No.	214175
description	temperature probe thermocouple K (NiCr-Ni) cable glass fibre probe -50 up to 1150°C cable -50 up to +350°C connection triple thread probe ø5x290mm cable length 1.5m		

			
Part No.	379909	Ref. No.	214176 600463 600724
description	temperature probe thermocouple K (NiCr-Ni) cable Vetrotex probe -50 up to 1150°C cable -50 up to +350°C connection 3-wire thread probe ø5x120/300mm cable length 1.5m		
For models:	FFE21, FFE31, FFE41, FFE42, FFM31, FFM41, FFM42		

core probes

			
Part No.	379827	Ref. No.	601043
description	temperature probe thermocouple K (NiCr-Ni) cable PTFE probe -40 up to +250°C cable -40 up to +250°C connection 2-wire probe ø5x115/285mm thread cable length 1.5m handle ømm handle lengthmm L1 280mm L2 115mm		
For models:	FFE21, FFE31, FFE41, FFE41TWIN, FFE42, FFM21, FFM31, FFM41TWIN, FFS21, FFS31, FFS41, FFS42		

electronics

PCBs

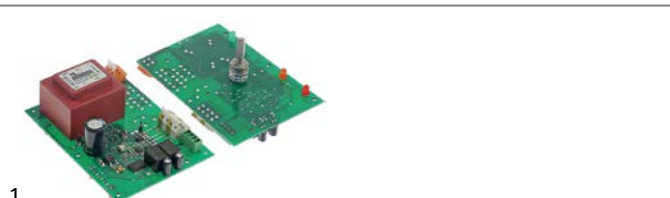
			
Part No.	403538	Ref. No.	101639
description	control PCB EASY / PROFI L 120mm W 90mm suitable for FRIFRI edition since 2006		
For models:	EASY211, EASY411, EASY422, PROF110, PROF16, PROF16+6, PROF18, PROF18+8		

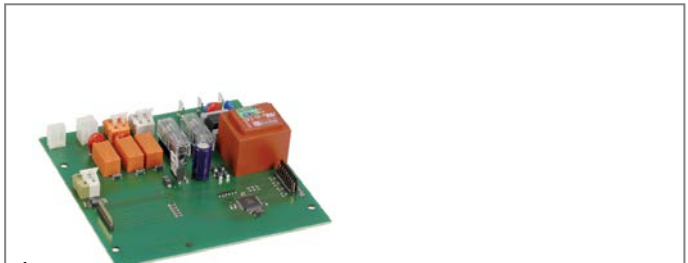
			
Part No.	400844	Ref. No.	101335
description	control PCB for fryer L 125mm W 125mm		
For models:	FFS21, FFS31, FFS41, FFS42		

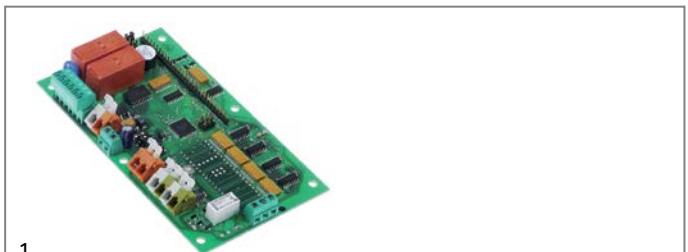
			
Part No.	402993	Ref. No.	214113
description	control PCB fryer ELLEGANCE L 140mm W 80mm with display		
For models:	ELEGANCE-M211, ELEGANCE-M311, ELEGANCE-M411, ELEGANCE-M422, ELEGANCE-S211, ELEGANCE-S311, ELEGANCE-S411, ELEGANCE-S422, V05M211, V05M311, V05M411, V05M422		

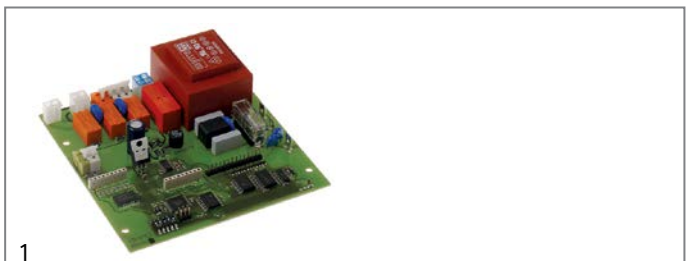
			
Part No.	400650	Ref. No.	101406
description	control PCB fryer FFE 21/31/41		
For models:	FFE21, FFE31, FFE41, FFE41TWIN, FFE42, FFM21, FFM31, FFM41TWIN		

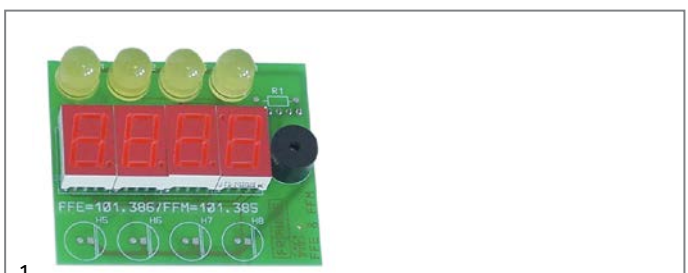
			
Part No.	400638	Ref. No.	101386
description	display for fryer		
For models:	FFE21, FFE31, FFE41, FFE41TWIN, FFE42, FFM21, FFM31, FFM41TWIN		

1

Part No.	400852	Ref. No.	300917
description	PCB		



1

Part No.	401619	Ref. No.	300917
description	PCB		
For models:	FFE21, FFE31, FFE41, FFE42, FFM31, FFM41, FFM42		



1

Part No.	401836	Ref. No.	402022
description	PCB		
For models:	FFE21, FFE31, FFE41, FFE41TWIN, FFE42, FFM21, FFM31, FFM41TWIN, FFS21, FFS31, FFS41, FFS42		



1

Part No.	403146	Ref. No.	101613
description	PCB fryer 2840/FFSE98 L 126mm W 126mm		



1

Part No.	400854	Ref. No.	300918
description	power PCB fryer FFE 21/31/41 edition since 1995		
For models:	FFE21, FFE31, FFE41, FFE42, FFM31, FFM41, FFM42		

keypads

front foils



1

Part No.	400584	Ref. No.	300989
description	keypad foil		
For models:	FFM31		



1

Part No.	400586	Ref. No.	300990
description	keypad foil		
For models:	FFM41		



1

Part No.	400609	Ref. No.	300991
description	keypad foil		
For models:	FFM42		



1

Part No.	400618	Ref. No.	301302
description	keypad foil		
For models:	FFE21, FFM21		



1

Part No.	400633	Ref. No.	301303
description	keypad foil		
For models:	FFE31, FFM31		





1

Part No.	400635	Ref. No.	301304
description	keypad foil		
For models:	FFE41		



			
1			
Part No.	400636	Ref. No.	301305
description	keypad foil		
For models:	FFE42		

			
1			
Part No.	400855	Ref. No.	300992
description	keypad foil		
For models:	FFE21, FFM31		

			
1			
Part No.	400856	Ref. No.	300993
description	keypad foil		
For models:	FFE31, FFM41		

			
1			
Part No.	400858	Ref. No.	300995
description	keypad foil		
For models:	FFE42		

keypad units

			
1			
Part No.	401695	Ref. No.	211090
description	keypad unit fryer BASIC211-422/BUSINESS211-422 L 140mm W 140mm		
For models:	BASIC211, BASIC311, BASIC411, BASIC422, BUSINESS211, BUSINESS311, BUSINESS411, BUSINESS422, VO3BASIC211, VO3BASIC311, VO3BASIC411, VO3BASIC422, VO3BUSINESS211, VO3BUSINESS311, VO3BUSINESS411, VO3BUSINESS422, VO3COMFORT211, VO3COMFORT311, VO3COMFORT411, VO3COMFORT422		

			
1			
Part No.	403120	Ref. No.	216191
description	keypad unit fryer EASY PLUS L 93mm W 155mm suitable for FRIFRI mounting pos. buttons 4		

electric accessories

cables

accessories

cable glands

threaded cable glands

screw connections

			
1			
Part No.	551065	Ref. No.	400848
description	cable gland thread PG7 cable \varnothing 5mm mounting \varnothing 12.5mm Qty 1 plastic WS 15 L 29mm		
For models:	FFE21, FFE31, FFE41, FFE41TWIN, FFE42, FFM21, FFM31, FFM41, FFM41TWIN, FFM42, FFS21, FFS31, FFS41, FFS42		

fastening nuts

			
1			
Part No.	551066	Ref. No.	400849
description	nut thread PG7 plastic mounting \varnothing mm Qty 1 cable \varnothing mm		
For models:	FFE21, FFE31, FFE41, FFE41TWIN, FFE42, FFM21, FFM31, FFM41, FFM41TWIN, FFM42, FFS21, FFS31, FFS41, FFS42		

terminals

connection terminals with faston connections

			
1			
Part No.	551064	Ref. No.	401019
description	rail-mounted terminal block 8-pole connection grip connection cross section 2.5mm ²		
For models:	FFE21, FFE31, FFE41, FFE41TWIN, FFE42, FFM21, FFM31, FFM41, FFM41TWIN, FFM42, FFS21, FFS31, FFS41, FFS42		



equipment-specific units

for deep fryers

lids



1

Part No.	970808	Ref. No.	300938 301194
description	lid for fryer SS L 323mm W 173mm H 7mm		
For models:	ECO4, ECO4+4		

miscellaneous



1

Part No.	694557	Ref. No.	101074
description	guide bar for contol plastic L 79mm W 13mm H 8mm		
For models:	ECO4, ECO4+4, ECO6, ECO6+6		



1

Part No.	694341	Ref. No.	101011
description	guide bar L 150mm W 20mm H 5mm		
For models:	FT10, FT4, FT4+4, FT6, FT8, PROF10, PROF16, PROF16+6, PROF18, PROF18+8		



1

Part No.	694349	Ref. No.	214160 600675
description	hose complete for draining silicone L 1500mm		
For models:	BASIC211, BASIC311, BASIC411, BASIC412, BASIC422, BUSINESS211, BUSINESS311, BUSINESS411, BUSINESS412, BUSINESS422, ELEGANCE-M211, ELEGANCE-M311, ELEGANCE-M411, ELEGANCE-M412, ELEGANCE-M422, ELEGANCE-S211, ELEGANCE-S311, ELEGANCE-S411, ELEGANCE-S412, ELEGANCE-S422, FFE21, FFE31, FFE41, FFE41TWIN, FFE42, FFM21, FFM31, FFM41, FFM41TWIN, FFM42, FFS21, FFS31, FFS41, FFS42, V05M211, V05M311, V05M411, V05M412, V05M422, VO3BASIC211, VO3BASIC311, VO3BASIC411, VO3BASIC412, VO3BASIC422, VO3BUSINESS211, VO3BUSINESS311, VO3BUSINESS411, VO-3BUSINESS412, VO3BUSINESS422, VO3COMFORT211...(Other models you can see in the webshop)		



1

Part No.	550369	Ref. No.	998999 Polyamid P M6/6,1
description	shim for thermostat		

knobs

universal knobs



1

Part No.	110163	Ref. No.	09741069
description	knob switch zero mark ø 42mm shaft 6x4.6mm shaft flat left black		
For models:	DUOFOUR, SALAMANDER		

producer-specific knobs

FRIFRI



1

Part No.	110168	Ref. No.	32-09 400545
description	knob ø 40mm		





1

Part No.	110879	Ref. No.	400769
description	knob switch zero mark ø 40mm shaft 6x4.6mm shaft flat left black		
For models:	ECO4, ECO4+4, ECO6, ECO6+6		



			
1			
Part No.	110163	Ref. No.	09741069
description	knob switch zero mark ø 42mm shaft ø 6x4.6mm shaft flat left black		
For models:	DUOFOUR, SALAMANDER		

			
1			
Part No.	110164	Ref. No.	400755
description	knob switch zero mark ø 45mm		
For models:	D4, D6, D8, OPTIMA-E20, OPTIMA-E22, OPTIMA-E30, OPTIMA-E32, OPTIMA-E40, OPTIMA-E42, OPTIMA-E47, OPTIMA-E48		

			
1			
Part No.	110258	Ref. No.	09741058 32-07
description	knob switch zero mark ø 45mm shaft ø 6x4.6mm shaft flat lower black		

			
1			
Part No.	110880	Ref. No.	400545
description	knob switch zero mark ø 54mm shaft ø 6x4.6mm shaft flat lower black		
For models:	FF21, FF31, FF41, FF42, FFS18G, FFS21, FFS25G, FFS31, FFS41, FFS42, FT10, FT4, FT4+4, FT6, FT8, SIMPLY-S18, SIMPLY-S25		

			
1			
Part No.	112884	Ref. No.	400545-1
description	knob switch zero mark t.max.°C ø 50mm shaft ø 6.5mm shaft flat black		

filters

deep fryer filters

			
1			
Part No.	970782	Ref. No.	101159
description	oil filter W 190mm L 290mm for fryer H 170mm without handle suitable for FRIFRI		
For models:	BASIC311, BASIC411, BASIC412, BUSINESS311, BUSINESS411, BUSINESS412, ELEGANCE-M311, ELEGANCE-M411, ELEGANCE-M412, ELEGANCE-S311, ELEGANCE-S411, ELEGANCE-S412, FFE31, FFE41, FFE41TWIN, FFM31, FFM41, FFM41TWIN, FFS31, FFS41, V05M311, V05M411, V05M412, VO3BASIC311, VO3BASIC411, VO3BASIC412, VO3BUSINESS411, VO3BUSINESS412, VO3COMFORT311, VO3COM-FORT411, VO3COMFORT412		

			
1			
Part No.	970738	Ref. No.	600696
description	oil filter W 225mm L 280mm H 170mm		

equipment feet and end caps

bolting feet

			
1			
Part No.	692331	Ref. No.	400354
description	equipment foot L 35mm W 35mm H 25mm bore ø 5mm mounting distance 14mm		
For models:	D4, D6, D8, FT10, FT4, FT4+4, FT6, FT8, PROFI10, PROFI6, PROFI6+6, PROFI8, PROFI8+8		



baskets

fryer baskets

FRIFRI



1

Part No.	970178	Ref. No.	101010 old version
description	fryer basket L1 250mm W1 130mm H1 100mm chrome-plated steel edition until 12/2006		



1

Part No.	970179	Ref. No.	300716
description	fryer basket L1 250mm W1 215mm H1 105mm L2 500mm H2 160mm H3 220mm chrome-plated steel		
For models:	D6, FT10, FT6, FT8, PROF110, PROF16, PROF16+6		



1

Part No.	970176	Ref. No.	300941
description	fryer basket L1 260mm W1 130mm H1 100mm chrome-plated steel		



1

Part No.	970287	Ref. No.	300941
description	fryer basket L1 260mm W1 140mm H1 100mm L2 220mm H2 165mm H3 190mm chrome-plated steel		
For models:	ECO4, ECO4+4		



1

Part No.	970763	Ref. No.	101010
description	fryer basket L1 260mm W1 145mm H1 100mm edition since 01/2007		
For models:	D4, D8, FT4, FT4+4, FT8		



1

Part No.	970288	Ref. No.	300942
description	fryer basket L1 260mm W1 190mm H1 105mm chrome-plated steel		
For models:	ECO6, ECO6+6		



1

Part No.	970481	Ref. No.	300717
description	fryer basket L1 263mm W1 313mm H1 105mm L2 200mm H2 180mm H3 210mm		
For models:	D8, FT10, FT8, PROF18, PROF18+8		





1

Part No.	970290	Ref. No.	301093
description	fryer basket L1 275/345mm W1 108mm H1 155mm L2 585mm H2 280mm H3 315mm stainless steel		
For models:	BASIC311, BUSINESS311, ELEGANCE-M311, ELEGANCE-S311, FFE21, FFE31, FFM31, FFS31, V05M311, V03BASIC311, V03BUSINESS311, V03COMFORT311		



			
1			
Part No.	970289	Ref. No.	100831
description	fryer basket L1 275/345mm W1 140mm H1 155mm L2 585mm H2 280mm H3 315mm stainless steel handle height 310mm		
For models:	BASIC211, BASIC411, BASIC412, BASIC422, BUSINESS211, BUSINESS411, BUSINESS412, BUSINESS422, EASY211, EASY411, EASY422, ELEGANCE-M211, ELEGANCE-M411, ELEGANCE-M412, ELEGANCE-M422, ELEGANCE-S211, ELEGANCE-S411, ELEGANCE-S412, ELEGANCE-S422, FF21, FF41, FF42, FFE21, FFE41, FFE41TWIN, FFE42, FFM21, FFM41, FFM41TWIN, FFM42, FFS21, FFS41, FFS42, V05M211, V05M411, V05M412, V05M422, VO3BASIC211, VO3BASIC411, VO3BASIC412, VO3BASIC422, VO3BUSINESS211, VO3BUSINESS411, VO3BUSINESS412, VO3BUSINESS422, VO3COMFORT211, VO3COMFORT411, VO3COMFORT412, VO3COMFORT422		

			
1			
Part No.	970180	Ref. No.	600216
description	fryer basket L1 275mm W1 160mm H1 135mm chrome-plated steel		
For models:	OPTIMA-E20, OPTIMA-E22, OPTIMA-E40, OPTIMA-E42, OPTIMA-E47, OPTIMA-E48, OPTIMA-EE20, OPTIMA-EE22, OPTIMA-EE40, OPTIMA-EE42, OPTIMA-EE47, OPTIMA-EE48		

			
1			
Part No.	970291	Ref. No.	100761
description	fryer basket L1 345mm W1 220mm H1 155mm L2 585mm H2 280mm H3 315mm stainless steel		
For models:	BASIC311, BUSINESS311, ELEGANCE-M311, ELEGANCE-S311, FF31, FFE31, FFM31, FFS31, V05M311, VO3BASIC311, VO3BUSINESS311, VO3COMFORT311		

crumb screens

			
1			
Part No.	970670	Ref. No.	300820
description	crumb screen L 350mm W 152mm		
For models:	EASY211, EASY422, FF21, FF42, FFE21, FFE42, FFM21, FFM42, FFS21, FFS42		

gaskets

special gaskets

thermostat gaskets

			
1			
Part No.	550490	Ref. No.	400373
description	gasket for thermostat ED ø 18.5mm ID ø 12.5mm thickness 5.5mm equiv. no. 400373 suitable for FRIFRI		
For models:			

GASTROPARTS.COM

