



GASTROPARTS

Forved

[EN] Equipment

[DE] Geräte

[ES] Aparatos

[FR] Équipement

[IT] Attrezzature

[PL] Urządzenia

[RU] Оборудование

✉ gastroparts@gastroparts.com

☎ +48 56 657 00 66

📘 fb.com/gastroparts.global

GASTROPARTS.COM





heating elements

heating elements for bain maries

1	
Part No.	416887
Ref. No.	SNACKRESIS01
description	heating element 1350W 230V heating circuits 1 L 385mm W 225mm connection male faston 6.3mm connection distance 110mm tube ø 8.5mm dry heating element W1 50mm W2 125mm H 22mm

1	
Part No.	416884
Ref. No.	VETRRES02 VETRRES03
description	heating element 700W 230V heating circuits 1 L 500mm W 270mm connection male faston 6.3mm connection distance 257mm connection length 20mm tube ø 6.3mm dry heating element

heating elements for fryers

2 hole fixing

1	
Part No.	416891
Ref. No.	3108
description	heating element 3000W 230V heating circuits 1 L 362mm W 65mm H 240mm L1 57mm L2 305mm H1 192mm H2 48mm thread 1/4" tube ø 8.5mm 2 hole fixing connection M5 fryer heaters windings 4

Part No.	416891	Ref. No.	3108	
description	heating element 3000W 230V heating circuits 1 L 362mm W 65mm H 240mm L1 57mm L2 305mm H1 192mm H2 48mm thread 1/4" tube ø 8.5mm 2 hole fixing connection M5 fryer heaters windings 4			
spare parts for	416891			
	Part No.	510417	Ref. No.	—
	flat gasket fibre ED ø 20mm ID ø 14mm thickness 2mm Qty 1 pcs			
accessories for	416891			
	Part No.	501318	Ref. No.	—
	nut thread 1/4" H 6.5mm SS WS 22 Qty 1 pcs			
	Part No.	503045	Ref. No.	—
	nut thread 1/4" H 4.5mm brass WS 17 Qty 1 pcs			
	Part No.	560112	Ref. No.	—
	plain washer ID ø 5.3mm ED ø 10mm thickness 1mm SS Qty 20 pcs DIN 125A for thread M5			
	Part No.	560132	Ref. No.	—
	hexagonal nut thread M5 H 4mm WS 8 SS DIN/ISO DIN 934 / ISO 4032/8673 Qty 20 pcs			

1	
Part No.	416892
Ref. No.	3108A
description	heating element 4000W 230V heating circuits 1 L 347mm W 85mm H 235mm L1 47mm L2 300mm H1 195mm H2 40mm thread 1/4" mounting distance 77mm tube ø 8.5mm 2 hole fixing connection M5 fryer heaters windings 4



Part No.	416892	Ref. No.	3108A	
description	heating element 4000W 230V heating circuits 1 L 347mm W 85mm H 235mm L1 47mm L2 300mm H1 195mm H2 40mm thread 1/4" mounting distance 77mm tube ø 8.5mm 2 hole fixing connection M5 fryer heaters windings 4			
accessories for	416892			
	Part No.	361182	Ref. No.	—
	nut thread 1/4" H 5mm nickel-plated brass WS 17 Qty 1 pcs			
	Part No.	510417	Ref. No.	—
	flat gasket fibre ED ø 20mm ID ø 14mm thickness 2mm Qty 1 pcs			
	Part No.	520228	Ref. No.	—
	tooth lock washer ID ø 15.3mm ED ø 24mm steel Qty 1 pcs for thread M14			
	Part No.	550262	Ref. No.	—
	flat gasket copper ED ø 20mm ID ø 14mm thickness 2mm			
	Part No.	560112	Ref. No.	—
	plain washer ID ø 5.3mm ED ø 10mm thickness 1mm SS Qty 20 pcs DIN 125A for thread M5			
	Part No.	560132	Ref. No.	—
	hexagonal nut thread M5 H 4mm WS 8 SS DIN/ISO DIN 934 / ISO 4032/8673 Qty 20 pcs			

1	
Part No.	416890
Ref. No.	3111
description	heating element 1670W 230V heating circuits 1 L 360mm W 85mm H 233mm L1 60mm L2 300mm H1 200mm H2 48mm thread 1/4" mounting distance 77mm tube ø 8.5mm 2 hole fixing connection M5 connection length 25mm fryer heaters windings 3

Part No.	416890	Ref. No.	3111	
description	heating element 1670W 230V heating circuits 1 L 360mm W 85mm H 233mm L1 60mm L2 300mm H1 200mm H2 48mm thread 1/4" mounting distance 77mm tube ø 8.5mm 2 hole fixing connection M5 connection length 25mm fryer heaters windings 3			
accessories for	416890			
	Part No.	361182	Ref. No.	—
	nut thread 1/4" H 5mm nickel-plated brass WS 17 Qty 1 pcs			
	Part No.	510417	Ref. No.	—
	flat gasket fibre ED ø 20mm ID ø 14mm thickness 2mm Qty 1 pcs			
	Part No.	520228	Ref. No.	—
	tooth lock washer ID ø 15.3mm ED ø 24mm steel Qty 1 pcs for thread M14			
	Part No.	550262	Ref. No.	—
	flat gasket copper ED ø 20mm ID ø 14mm thickness 2mm			





Table continues overleaf

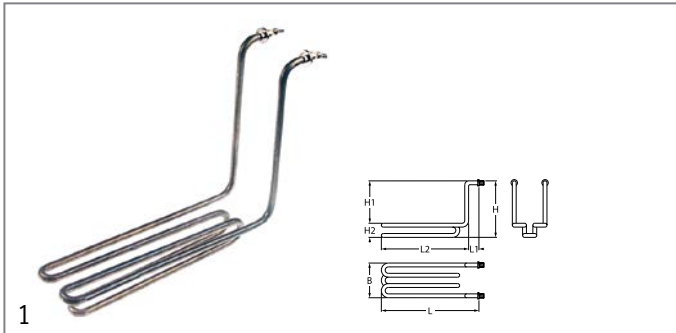

accessories for	416890			
	Part No.	560112	Ref. No.	—
	plain washer ID ø 5.3mm ED ø 10mm thickness 1mm SS Qty 20 pcs DIN 125A for thread M5			
	Part No.	560132	Ref. No.	—
	hexagonal nut thread M5 H 4mm WS 8 SS DIN/ISO DIN 934 / ISO 4032/8673 Qty 20 pcs			



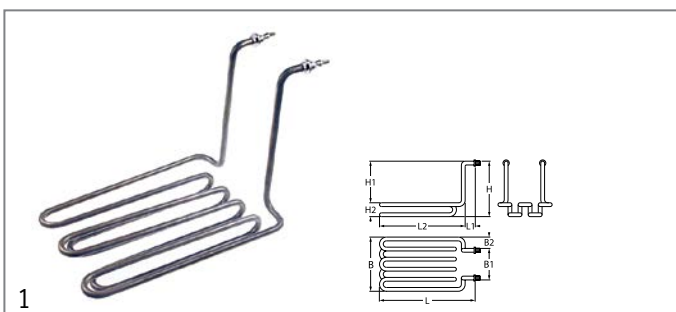

Part No.	416889	Ref. No.	3966
description	heating element 2000W 230V heating circuits 1 L 310mm W 73mm H 225mm L1 40mm L2 270mm H1 190mm H2 36mm thread 1/4" mounting distance 65mm tube ø 8.5mm 2 hole fixing connection M5 fryer heaters windings 3		

accessories for	416889			
	Part No.	361182	Ref. No.	—
	nut thread 1/4" H 5mm nickel-plated brass WS 17 Qty 1 pcs			
	Part No.	510417	Ref. No.	—
	flat gasket fibre ED ø 20mm ID ø 14mm thickness 2mm Qty 1 pcs			
	Part No.	520228	Ref. No.	—
	tooth lock washer ID ø 15.3mm ED ø 24mm steel Qty 1 pcs for thread M14			
	Part No.	550262	Ref. No.	—
	flat gasket copper ED ø 20mm ID ø 14mm thickness 2mm			
	Part No.	560112	Ref. No.	—
	plain washer ID ø 5.3mm ED ø 10mm thickness 1mm SS Qty 20 pcs DIN 125A for thread M5			
	Part No.	560132	Ref. No.	—
	hexagonal nut thread M5 H 4mm WS 8 SS DIN/ISO DIN 934 / ISO 4032/8673 Qty 20 pcs			



Part No.	416888	Ref. No.	3955
description	heating element 3500W 230V heating circuits 2 L 300mm W 115mm H 232mm L1 28mm L2 272mm H1 190mm H2 42mm thread 1/4" tube ø 8.5mm 2 hole fixing connection M5 immersion heater windings 5 W1 70mm W2 45mm		

accessories for	416888			
	Part No.	560112	Ref. No.	—
	plain washer ID ø 5.3mm ED ø 10mm thickness 1mm SS Qty 20 pcs DIN 125A for thread M5			

accessories for	416888			
	Part No.	560132	Ref. No.	—
	hexagonal nut thread M5 H 4mm WS 8 SS DIN/ISO DIN 934 / ISO 4032/8673 Qty 20 pcs			

heating elements for hot counters

Part No.	416883	Ref. No.	VETRESSCB80
description	heating element 230V		

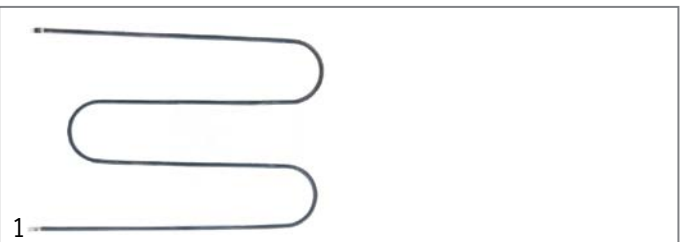

Part No.	416881	Ref. No.	VETRES01
description	heating element 400W 230V heating circuits 1 L 400mm W 280mm tube ø 6.3mm connection male faston 6.3mm dry heating element for vitrine		

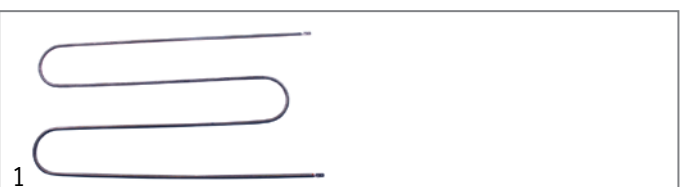

Part No.	416882	Ref. No.	VETRES02
description	heating element 500W 230V heating circuits 1 L 500mm W 275mm connection distance 268mm tube ø 6.3mm connection male faston 6.3mm dry heating element for vitrine		



Part No.	419010	Ref. No.	VETRES01
description	heating element 600W 230V heating circuits 1 L 400mm W 280mm tube ø 6.3mm connection male faston 6.3mm dry heating element for vitrine		

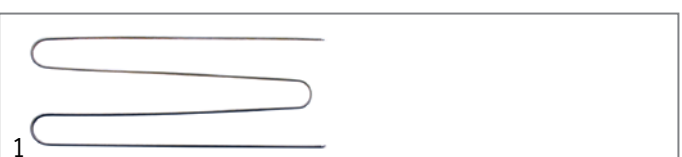

Part No.	418791	Ref. No.	VETRES03
description	heating element 900W 230V heating circuits 1 L 615mm W 265mm tube ø 6.3mm connection male faston 6.3mm dry heating element		

1

Part No.	416885	Ref. No.	VETRRES04
description	heating element 900W 230V heating circuits 1 L 870mm W 345mm connection distance 339mm connection length 20mm tube ø 6.3mm connection male faston 6.3mm dry heating element		

heating elements for contact grills



1

Part No.	416877	Ref. No.	GRILLRES02
description	heating element 1000W 230V L 180mm W 192mm H 18mm L1 5mm L2 175mm W1 53mm W2 86mm tube ø 8.5mm mounting pos. upper connection M5 windings 3 dry heating element		



1

Part No.	416879	Ref. No.	GRILLRES03
description	heating element 1200W 230V L 177mm W 257mm H 18mm L1 8mm L2 160mm W1 73mm W2 111mm tube ø 8.5mm connection length 24mm mounting pos. upper connection M4 windings 4 dry heating element		



1

Part No.	416878	Ref. No.	GRILLRES01
description	heating element 1400W 230V L 198mm W 220mm H 46mm W1 60mm W2 100mm tube ø 8.5mm connection M5 connection length 24mm mounting pos. lower dry heating element windings 4		



1

Part No.	416880	Ref. No.	GRILLRES04
description	heating element 1700W 230V L 198mm W 278mm H 40mm W1 60mm W2 168mm tube ø 8.5mm connection M4 connection length 23mm mounting pos. lower dry heating element windings 5		

heating elements for salamanders/toast-



1

Part No.	416874	Ref. No.	TOSTRESOR
description	heating element 450W 115V L 344mm thread M12x1 connection length 23mm tube ø 8.5mm connection male faston 6.3mm heating circuits 1 dry heating element toaster W 8.5mm H 8.5mm		

quartz heating elements



1

Part No.	416187	Ref. No.	TOSTRES01
description	quartz heating element 400W 115V L 260mm ø 12mm connection male faston 6.3mm mounting distance 24.8mm		



1

Part No.	418625	Ref. No.	TOSTRES02
description	quartz heating element 500W 115V L 365mm ø 10mm connection male faston 6.3mm		



1

Part No.	416873	Ref. No.	TOSTRES04
description	quartz heating element 500W 75V L 510mm ø 12mm connection male faston 6.3mm mounting distance 495mm 110hm		



1

Part No.	416871	Ref. No.	TOSTRES01
description	quartz heating element 800W 230V L 285mm		



hot plates

round

with radiused edge

for domestic and commercial kitchens



1

Part No.	490129	Ref. No.	SNACKPIAS1
description	hot plate ø 180mm 1500W 230V connection 4 screw clamps with 8mm spill ring		



1

Part No.	490130	Ref. No.	SNACKPIAS2
description	hot plate ø 220mm 2000W 230V connection 4 screw clamps with 8mm spill ring		

thermostats

bi-metal thermostats

bi-metal thermostats



1

Part No.	390323	Ref. No.	VETRTERMSICU
description	bi-metal thermostat hole distancemm switch-off temp. 145°C 1NC 1-pole 16A connection F6.3 M4		

control and safety thermostats

EGO

control thermostats

55.10/19_ series

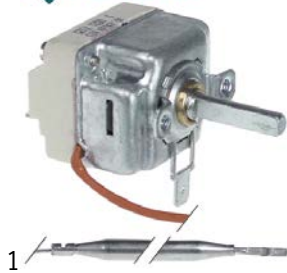

1

Part No.	375777	Ref. No.	3064
description	thermostat t.max. 180°C temperature range 70-180°C 1-pole 1NO 16A probe ø 6mm probe L 87mm capillary pipe 600mm capillary pipe isolated 350mm gland nut shaft ø 6x4.6mm shaft L 23mm shaft position upper rotation 270°		



1

Part No.	375002	Ref. No.	GRILLTERMOS
description	thermostat t.max. 320°C temperature range 55-320°C 1-pole 1NO 16A probe ø 3.1mm probe L 226mm capillary pipe 870mm capillary pipe isolated 850mm gland nut shaft L 23mm shaft position upper rotation 270°		

safety thermostats

55.32_ series



1

Part No.	375724	Ref. No.	03299/A
description	safety thermostat switch-off temp. 246°C 3-pole 20A probe ø 6mm probe L 79mm capillary pipe 1300mm capillary pipe isolated 1100mm gland nut probe SS		

IMIT / TEMPOMATIC / ARTERMO

control thermostats



1

Part No.	375620	Ref. No.	VETRTER120
description	thermostat t.max. 120°C temperature range 30-120°C 1-pole 1CO 15A probe ø 6.5mm probe L 95mm capillary pipe 1000mm capillary pipe isolated 1000mm gland nut shaft ø 6x4.6mm shaft L 19mm shaft position upper rotation 270°		

1

Part No.	375543	Ref. No.	3064
description	thermostat t.max. 190°C 1-pole gland nut shaft ø 6x4.6mm		

safety thermostats



1

Part No.	375542	Ref. No.	9004
description	safety thermostat LS1 8174 switch-off temp. 238°C 1-pole 15A probe ø 5mm probe L 100mm capillary pipe 550mm capillary pipe isolatedmm gland nut probe SS		

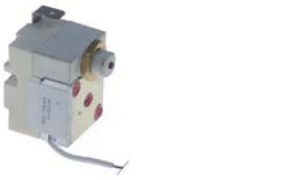

1

Part No.	375509	Ref. No.	9004
description	thermostat switch-off temp. 230°C 1-pole 1NC 16A probe ø 6mm probe L 62mm capillary pipe 450mm capillary pipe isolated 40mm gland nut probe screw connection M10x1 connection male faston 6.3mm		

CAMPINI

safety thermostats



1

Part No.	375915	Ref. No.	9004
description	safety thermostat switch-off temp. 232°C 1-pole 1NC 16A probe ø 5mm probe L 68mm capillary pipe 960mm capillary pipe isolated 70mm screw connection M10		

various

control thermostats



1

Part No.	375820	Ref. No.	3064
description	thermostat t.max. 190°C temperature range 0-190°C 1-pole 1CO 16A probe ø 4.5mm probe L 130mm capillary pipe 550mm shaft ø 6x4.6mm shaft L 19mm shaft position upper rotation 270° 250V		

switches and momentary switches

rocker/momentary rocker switches

30x22mm



1

Part No.	301003	Ref. No.	TOSTINTER	
description	rocker switch mounting measurements 30x22mm green 2NO 250V 16A illuminated 0-I connection male faston 6.3mm ambient temperature max. 125/55°C protection IP65			
accessories for	301003			
	Part No.	301036	Ref. No.	—
	protective cover internal size 30x22mm for rocker switch mounting measurementsmm			

microswitches

lever actuated



1

Part No.	345255	Ref. No.	03041/A
description	microswitch with lever 250V 16A 1CO connection male faston 6.3mm L 35mm L1 28mm ambient temperature max. 125°C mounting distance 22mm actuating force: 136g lever length 27mm		



1

Part No.	347684	Ref. No.	03041/B
description	microswitch with lever 250V 16A 2NO connection male faston 6.3mm L 36mm ambient temperature max. 125°C mounting distance 22.2mm type VRSR01AA1 actuating force: 145g		



cam switches

on/off

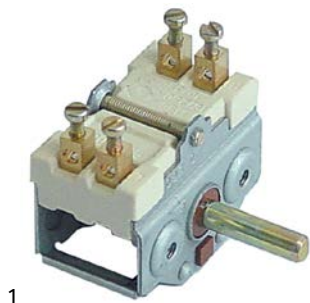

1

Part No.	300151	Ref. No.	03227/B
description	cam switch 2 operating positions 2NO sequence 0-1 16A shaft \varnothing 6x4.6mm shaft L 23mm connection screw ceramic		



1

Part No.	300176	Ref. No.	03227/A
description	cam switch 2 operating positions 4NO sequence 0-1 16A shaft \varnothing 6x4.6mm shaft L 23mm connection screw		

7-position

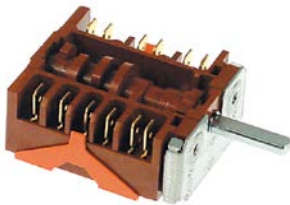

1

Part No.	300177	Ref. No.	SNACKCOMMUT
description	cam switch 7 operating positions 6NO sequence 0-1-2-3-4-5-6 16A shaft \varnothing 6x4.6mm shaft L 23mm connection male faston 6.3mm 7-position		

lamps

indicator lights

indicator light lenses

 \varnothing 10mm (type SR-3)

1

Part No.	359815	Ref. No.	3066
description	indicator light housings mounting measurements \varnothing 10mm clear Qty 1 pcs		



1

Part No.	359816	Ref. No.	3067
description	indicator light housings mounting measurements \varnothing 10mm green Qty 1 pcs		

indicator lamps for socket type SA / SC / SD / SF / SR



1

Part No.	359814	Ref. No.	3676
description	indicator lamp 230V clear connection cable 400mm cable material silicone Qty 1 pcs		

indicator lights (complete)

 \varnothing 10mm

with plug-in socket



1

Part No.	359374	Ref. No.	TOSTGEMMA
description	indicator light \varnothing 10mm 230V green		

 \varnothing 13mm

with plug-in socket



1

Part No.	359142	Ref. No.	GRILLAMPAD
description	indicator light \varnothing 13mm green 230V connection male faston 6.3mm temp.-resist. 120°C Qty 1 pcs		



1

Part No.	359143	Ref. No.	GRILLAMPAD GRILLGEMMA TOSTLAMP VETRIGEMMA
description	indicator light \varnothing 13mm yellow 230V connection male faston 6.3mm temp.-resist. 120°C Qty 1 pcs		



timers

mechanical timers

 <p>1</p>			
Part No.	350032	Ref. No.	Tosttimer
description	timer M2 2-pole operation time 15min impulse mechanical 2NO at 250V 16A permanent position no shaft ø 6x4.6mm shaft 6x4.6mm shaft L 18mm mounting distance 28mm connection rear		
accessories for	350032		
	Part No.	110366	Ref. No. Tosttimerman
	knob switch zero mark t.max.°C ø 44mm shaft ø 6x4.6mm shaft flat upper black		
	Part No.	110371	Ref. No. —
	dial plate graduation 15min permanent position no rotation 30-330° ø 60mm timers knob ø 45mm		

spare parts and accessories

knobs

 <p>1</p>			
Part No.	110366	Ref. No.	Tosttimerman
description	knob switch zero mark t.max.°C ø 44mm shaft ø 6x4.6mm shaft flat upper black		

contactors

GENERAL ELECTRIC (AEG)

power contactors

 <p>1</p>			
Part No.	380238	Ref. No.	9023 SALAMANDCONT
description	power contactor resistive load 20A 230VAC (AC3/400V) 8.4A/4kW main contacts 3NO auxiliary contacts 1NO connection screw connection type LS0510A type AEG LS0510A type GE MC1A 310A		

ignition parts

pilot burners

SIT

100 series

 <p>1</p>			
Part No.	107139	Ref. No.	03139
description	pilot burner SIT type 100 series 1 flame nozzle ø 0.2mm gas connectionmm		
spare parts for	107139		
	Part No.	100854	Ref. No. —
	pilot burner bracket double		
	Part No.	100885	Ref. No. —
	air mixing sleeve for pilot burner Qty 1 pcs		
	Part No.	107160	Ref. No. —
	pilot burner cap SIT 1 flame Hmm Lmm Qty 1 pcs		
accessories for	107139		
	Part No.	100904	Ref. No. —
	locking screw M10x1 for pipe ø 4mm Qty 1 pcs		
	Part No.	100905	Ref. No. —
	locking screw M10x1 for pipe ø 6mm Qty 1 pcs		
	Part No.	100998	Ref. No. —
	pilot burner bottom part nozzle ø 0.21mm suitable for 100 series		
	Part No.	102110	Ref. No. —
	pilot tube copper pipe ø 4mm thickness 1mm L 3000mm		
	Part No.	102111	Ref. No. —
	pilot tube copper pipe ø 6mm thickness 1mm L 3000mm		



accessories

ignition electrodes

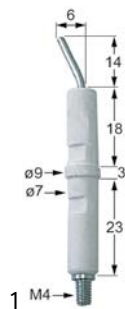

Part No. 100706 **Ref. No.** 3152

description ignition electrode connection M4 Qty 1 pcs

electrodes



Part No. 100706 **Ref. No.** 3152

description ignition electrode connection M4 Qty 1 pcs

gas nozzles

main nozzles

gas nozzles M12x1



Part No. 106568 **Ref. No.** FRIGUGELLI

description gas injector thread M12x1 WS 13 bore ø 1.25mm

equipment-specific units

for toasters

pliers

pliers



Part No. 690010 **Ref. No.** TOSTPINZA

description plier for toaster H 180mm total length 100mm

knobs

producer-specific knobs

FORVED



Part No. 112011 **Ref. No.** 3096

description knob switch zero mark ø 41mm shaft ø 6x4.6mm shaft flat upper black



Part No. 111550 **Ref. No.** SNACKMANCUC VETREMANTERM

description knob switch zero mark ø 48mm shaft ø 6x4.6mm shaft flat upper black

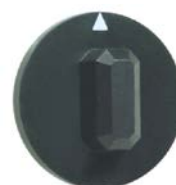

Part No. 110366 **Ref. No.** Tosttimerman

description knob switch zero mark t.max.°C°C ø 44mm shaft ø 6x4.6mm shaft flat upper black



handles and hand wheels

handle bars

handle bars



1

Part No.	693200	Ref. No.	GRILLIMPEGNO
description	handle rod		

bracket handles



1

Part No.	693440	Ref. No.	3063
description	pull handle mounting distance 88mm for fryer		
For models:	FLT 8+8BS, FLT 8BS, FLT12+12B, FLT12+12BS, FLT12B, FLT12BS, FLT20+20B, FLT20+20BS, FLT20B, FLT20BS		

hinges

oven hinges

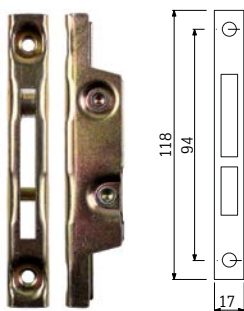



1

Part No.	700001	Ref. No.	03808c
description	opposite support L 118mm W 17mm mounting distance 94mm		



1

Part No.	700006	Ref. No.	03478D
description	oven hinge mounting distance 173mm mounting distance 2 105mm lug mounting 14mm lever length 120mm groove distance 11mm spring thickness 3.5mm mounting ear position left spring length 112mm W 25mm		
accessories for	700006		
	Part No.	700001	Ref. No.
			03808c
	opposite support L 118mm W 17mm mounting distance 94mm		

accessories for	700006		
	Part No.	700007	Ref. No.
			03478s
	oven hinge mounting distance 173mm mounting distance 2 105mm lug mounting 14mm lever length 120mm groove distance 11mm spring thickness 3.5mm mounting ear position right spring length 112mm W 25mm		

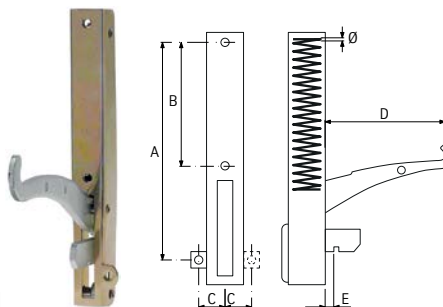

1

Part No.	700007	Ref. No.	03478s
description	oven hinge mounting distance 173mm mounting distance 2 105mm lug mounting 14mm lever length 120mm groove distance 11mm spring thickness 3.5mm mounting ear position right spring length 112mm W 25mm		

accessories for	700007		
	Part No.	700001	Ref. No.
			03808c
	opposite support L 118mm W 17mm mounting distance 94mm		

	Part No.	700006	Ref. No.
			03478D
	oven hinge mounting distance 173mm mounting distance 2 105mm lug mounting 14mm lever length 120mm groove distance 11mm spring thickness 3.5mm mounting ear position left spring length 112mm W 25mm		

fittings for catering equipment

outlet taps

universal

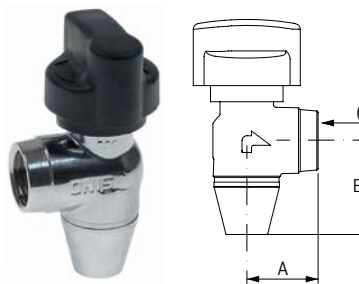

1

Part No.	540747	Ref. No.	FRIGRUBINFR8
description	outlet tap chrome-plated brass angled W 30mm H 40mm thread 1/2" IT		



producer-specific

FORVED



1			
Part No.	514006	Ref. No.	3962
description	drain pipe L 200mm thread ø 22mm		



1			
Part No.	540952	Ref. No.	3964
description	outlet tap L 84mm fryer lever handle grommet ø 30mm grommet length 29mm thread 3/4" IT handle length 81mm		

baskets

fryer baskets

FORVED



1			
Part No.	970372	Ref. No.	3960
description	fryer basket W1 190mm L1 245mm H1 110mm L2 450mm H2 225mm		



1			
Part No.	970373	Ref. No.	3967
description	fryer basket W1 210mm L1 250mm H1 110mm		



1			
Part No.	970701	Ref. No.	3961
description	fryer basket W1 220mm L1 280mm H1 110mm H2 200mm		



1			
Part No.	970374	Ref. No.	3961
description	fryer basket W1 235mm L1 270mm H1 110mm H2 210mm chrome-plated steel		



1			
Part No.	970004	Ref. No.	100117
description	fryer basket W1 313mm L1 490mm H1 115mm		



1			
Part No.	970376	Ref. No.	3323
description	fryer basket W1 337mm L1 606mm H1 115mm		

springs

torsion springs



1			
Part No.	693199	Ref. No.	GRILLMOLLA
description	torsion spring ø 21mm L1 38mm L2 118mm L3 38mm wire gauge ø 3.8mm		



valves and tank inlets

ball valves

universal

ball valves with lever handle



1

Part No.	540910	Ref. No.	3118
description	ball valve connection 3/4" IT - hose ø19mm total length 110mm with lever handle handle length 95mm		

GASTROPARTS.COM

