



**GASTROPARTS**

# Fornitalia

- [EN]** Equipment
- [DE]** Geräte
- [ES]** Aparatos
- [FR]** Équipement
- [IT]** Attrezzature
- [PL]** Urządzenia
- [RU]** Оборудование

✉ [gastroparts@gastroparts.com](mailto:gastroparts@gastroparts.com)

☎ +48 56 657 00 66

📘 [fb.com/gastroparts.global](https://fb.com/gastroparts.global)

**GASTROPARTS.COM**





## heating elements

### heating elements for pizza ovens



<b>Part No.</b>	418094	<b>Ref. No.</b>	105/65Z15 K105/65 15
<b>description</b>	heating element 1000W 230V L 600mm W 95mm thread 1/4" mounting distance 86mm connection length 84mm connection M4 tube ø 8.5mm heating circuits 1 dry heating element mounting pos. lower 2 hole fixing		

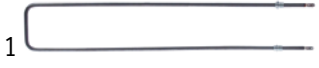

<b>Part No.</b>	418987	<b>Ref. No.</b>	K65/65 18
<b>description</b>	heating element 1000W 230V L 604mm W 113mm thread 1/4" mounting distance 105mm connection length 85mm connection M4 tube ø 8.5mm heating circuits 1 dry heating element mounting pos. upper 2 hole fixing pizza oven		







<b>Part No.</b>	419145	<b>Ref. No.</b>	K105/6518 K65/65 15
<b>description</b>	heating element 1000W 230V L 610mm W 94mm thread 1/4" mounting distance 86mm connection length 87mm connection M4 tube ø 8.5mm heating circuits 1 dry heating element mounting pos. upper 2 hole fixing		



<b>Part No.</b>	419187	<b>Ref. No.</b>	K65/105 15
<b>description</b>	heating element 1600W 230V L 1000mm W 115mm thread 1/4" mounting distance 106.5mm connection length 85mm connection M4 tube ø 8.5mm heating circuits 1 dry heating element mounting pos. lower 2 hole fixing pizza oven		





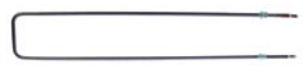

<b>Part No.</b>	418089	<b>Ref. No.</b>	40/60Z6
<b>description</b>	heating element 600W 230V L 480mm W 120mm thread 1/4" mounting distance 112mm connection length 42mm connection male faston 6.3mm tube ø 8.5mm heating circuits 1 dry heating element mounting pos. upper 2 hole fixing		
<b>accessories for</b>	418089		
	<b>Part No.</b>	361182	<b>Ref. No.</b> —
	nut thread 1/4" H 5mm nickel-plated brass WS 17 Qty 1 pcs		
	<b>Part No.</b>	510417	<b>Ref. No.</b> —
	flat gasket fibre ED ø 20mm ID ø 14mm thickness 2mm Qty 1 pcs		
	<b>Part No.</b>	520228	<b>Ref. No.</b> —
	tooth lock washer ID ø 15.3mm ED ø 24mm steel Qty 1 pcs for thread M14		
	<b>Part No.</b>	550262	<b>Ref. No.</b> —
	flat gasket copper ED ø 20mm ID ø 14mm thickness 2mm		



<b>Part No.</b>	418092	<b>Ref. No.</b>	65/65Z15 K65/65 15 K65/65 15 old version
<b>description</b>	heating element 600W 230V L 595mm W 122mm thread 1/4" mounting distance 115mm connection length 84mm connection M4 tube ø 8.5mm heating circuits 1 dry heating element mounting pos. lower 2 hole fixing		



<b>Part No.</b>	418090	<b>Ref. No.</b>	40/60Z7 BJ07
<b>description</b>	heating element 700W 230V L 480mm W 120mm thread 1/4" mounting distance 111mm connection length 55mm connection male faston 6.3mm tube ø 8.5mm heating circuits 1 dry heating element mounting pos. lower 2 hole fixing		
<b>accessories for</b>	418090		
	<b>Part No.</b>	361182	<b>Ref. No.</b> —
	nut thread 1/4" H 5mm nickel-plated brass WS 17 Qty 1 pcs		
	<b>Part No.</b>	510417	<b>Ref. No.</b> —
	flat gasket fibre ED ø 20mm ID ø 14mm thickness 2mm Qty 1 pcs		
	<b>Part No.</b>	520228	<b>Ref. No.</b> —
	tooth lock washer ID ø 15.3mm ED ø 24mm steel Qty 1 pcs for thread M14		
	<b>Part No.</b>	550262	<b>Ref. No.</b> —
	flat gasket copper ED ø 20mm ID ø 14mm thickness 2mm		

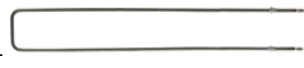

<b>Part No.</b>	418097	<b>Ref. No.</b>	105/105Z18
<b>description</b>	heating element 900W 230V L 1000mm W 195mm thread M14x1.5 mounting distance 186mm connection length 85mm connection M4 tube ø 8.5mm dry heating element mounting pos. upper 2 hole fixing		



## thermostats

## control and safety thermostats

EGO

control thermostats

55.10/19\_series



<b>Part No.</b>	375253	<b>Ref. No.</b>	40/60Z17
-----------------	--------	-----------------	----------

<b>description</b>	thermostat t.max. 455°C temperature range 85-455°C 1-pole 1NO 16A probe ø 3.9mm probe L 228mm capillary pipe 870mm capillary pipe isolated 660mm gland nut shaft ø 6x4.6mm shaft L 23mm shaft position upper rotation 270°
--------------------	--

safety thermostats

55.10/19\_series



<b>Part No.</b>	375191	<b>Ref. No.</b>	40/60Z19
-----------------	--------	-----------------	----------

<b>description</b>	safety thermostat switch-off temp. 500°C 1-pole 16A probe ø 3.9mm probe L 230mm capillary pipe 870mm capillary pipe isolated 660mm gland nut probe
--------------------	--

## switches and momentary switches

## cam switches

on/off

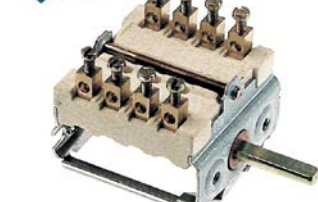

<b>Part No.</b>	300176	<b>Ref. No.</b>	40/60Z18
-----------------	--------	-----------------	----------

<b>description</b>	cam switch 2 operating positions 4NO sequence 0-1 16A shaft ø 6x4.6mm shaft L 23mm connection screw
--------------------	---

## lamps

## indicator lights

indicator lights (complete)

ø 6mm



<b>Part No.</b>	359336	<b>Ref. No.</b>	40/60Z12
-----------------	--------	-----------------	----------

<b>description</b>	indicator light ø 6mm 230V green
--------------------	----------------------------------

## screw-on/push-on fit

halogen lamp

for socket GU5.3 / GU10 / GZ5.3



1

<b>Part No.</b>	359496	<b>Ref. No.</b>	65/65Z10 K65/65
-----------------	--------	-----------------	--------------------

<b>description</b>	halogen lamp socket GU5.3 12V 50W temp.-resist. 300°C
--------------------	---

## oven lamps

producer-specific oven lamps

FORNITALIA



1

<b>Part No.</b>	359495	<b>Ref. No.</b>	65/65Z11
-----------------	--------	-----------------	----------

<b>description</b>	frame without socket
--------------------	----------------------



1

<b>Part No.</b>	359497	<b>Ref. No.</b>	65/65Z9 K65/6509
-----------------	--------	-----------------	---------------------

<b>description</b>	lamp glass ø 52mm
--------------------	-------------------



1

<b>Part No.</b>	359498	<b>Ref. No.</b>	65/65Z7 K65/6507
-----------------	--------	-----------------	---------------------

<b>description</b>	spring for lens
--------------------	-----------------



			
1			
<b>Part No.</b>	359496	<b>Ref. No.</b>	65/65Z10 K65/65
<b>description</b>	halogen lamp socket GU5.3 12V 50W temp.-resist. 300°C		

**lamps**  
halogen lamps  
for socket GU5,3 / GU10

			
1			
<b>Part No.</b>	359496	<b>Ref. No.</b>	65/65Z10 K65/65
<b>description</b>	halogen lamp socket GU5.3 12V 50W temp.-resist. 300°C		

**transformers**

open transformers

with clamp terminal

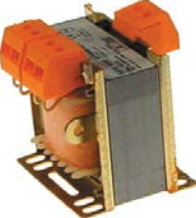
			
1			
<b>Part No.</b>	401176	<b>Ref. No.</b>	65/65Z26
<b>description</b>	transformer primary 230V secondary 10/24V 50VA		

for lighting

			
1			
<b>Part No.</b>	401177	<b>Ref. No.</b>	65/65Z24
<b>description</b>	transformer primary 230V secondary 11.5V 50W		

**probes**

producer-specific probes

			
1			
<b>Part No.</b>	379930	<b>Ref. No.</b>	65/65Z25
<b>description</b>	temperature probe thermocouple K (NiCr-Ni) cable Vetrotex probe -50 up to 1150°C cable -50 up to +350°C connection 2-wire thread probe ø3x100mm cable length 3.2m		

**electronics**

PCBs

			
1			
<b>Part No.</b>	401178	<b>Ref. No.</b>	105/105Z22 65/65 22 65/65Z22
<b>description</b>	control PCB		

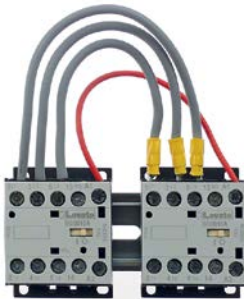
			
1			
<b>Part No.</b>	403643	<b>Ref. No.</b>	K65/65 23 (old version)
<b>description</b>	conversion kit pizza oven K65 suitable for FORNITALIA		

			
1			
<b>Part No.</b>	401179	<b>Ref. No.</b>	65/65Z23 K65/65 23 (old)
<b>description</b>	power PCB pizza oven K65 suitable for FORNITALIA		



1

<b>Part No.</b>	403072	<b>Ref. No.</b>	K65/65 23
<b>description</b>	power PCB pizza oven K65 suitable for FORNITALIA		

## keypads

### front foils

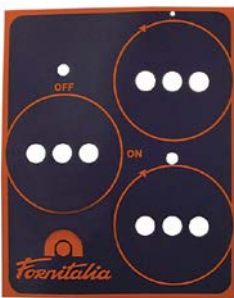

1

<b>Part No.</b>	693371	<b>Ref. No.</b>	40/60Z16
<b>description</b>	front foil		

## fans

### axial fans

#### import



1

<b>Part No.</b>	601158 <sup>1</sup>	<b>Ref. No.</b>	65/65Z20 B65/65 20
<b>description</b>	axial fan L 119mm W 119mm H 25mm 12VDC 5.4W bearing ball bearing connection cable 300mm plastic ADDA temp.-resist. -10 up to +70°C		

<sup>1</sup>with ball bearings

## accessories

### fan guards

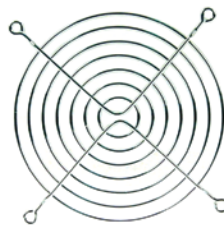

1

<b>Part No.</b>	601206	<b>Ref. No.</b>	65/65Z19
<b>description</b>	guard ø 115mm mounting distance 105mm for axial fan 119mm		

## equipment-specific units

### for pizza ovens

### springs



1

<b>Part No.</b>	693369	<b>Ref. No.</b>	65/65Z1 B65/65 01
<b>description</b>	torsion spring ø 22mm L2 51mm wire gauge ø 3.7mm L1 38mm L3 15mm		

### glass panels



1

<b>Part No.</b>	693374	<b>Ref. No.</b>	40/60Z1
<b>description</b>	glass panel L 258mm W 78mm thickness 4mm rectangular		



1

<b>Part No.</b>	693372	<b>Ref. No.</b>	16/K65/65 65/65Z16 K65/65 16
<b>description</b>	glass panel L 418mm W 103mm thickness 4mm rectangular		

firebricks



1

<b>Part No.</b>	850090	<b>Ref. No.</b>	K105/105 14
<b>description</b>	firebrick L 1025mm W 500mm H 15mm mounting pos. lower delivery freight forwarding company only		
<b>For models:</b>	KCK105/105		



1

<b>Part No.</b>	850092	<b>Ref. No.</b>	K65/105 14
<b>description</b>	firebrick L 1025mm W 605mm H 15mm mounting pos. lower delivery freight forwarding company only		



1

<b>Part No.</b>	850081	<b>Ref. No.</b>	KCK105/105 R5
<b>description</b>	firebrick L 1030mm W 160mm H 15mm with lamp duct mounting pos. side part right delivery freight forwarding company only		
<b>For models:</b>	KCK105/105		



1

<b>Part No.</b>	850082	<b>Ref. No.</b>	KCK105/105 R2
<b>description</b>	firebrick L 1030mm W 160mm H 15mm with probe duct mounting pos. side part left delivery freight forwarding company only		
<b>For models:</b>	KCK105/105		



1

<b>Part No.</b>	850083	<b>Ref. No.</b>	KCK105/105 R3
<b>description</b>	firebrick L 1045mm W 160mm H 15mm mounting pos. side part at the back delivery freight forwarding company only		
<b>For models:</b>	KCK105/105		



1

<b>Part No.</b>	850089	<b>Ref. No.</b>	KCK105/65 R4
<b>description</b>	firebrick L 1045mm W 325mm H 15mm mounting pos. upper delivery freight forwarding company only		
<b>For models:</b>	KCK105/65		



1



<b>Part No.</b>	850091	<b>Ref. No.</b>	KCK105/105 R4
<b>description</b>	firebrick L 1045mm W 520mm H 15mm mounting pos. upper delivery freight forwarding company only		
<b>For models:</b>	KCK105/105		

1



<b>Part No.</b>	850118	<b>Ref. No.</b>	K65/105 14
<b>description</b>	firebrick L 342mm W 605mm H 14mm mounting pos. lower delivery freight forwarding company only		
<b>For models:</b>	KCK65/105		

1



<b>Part No.</b>	850094	<b>Ref. No.</b>	K65/65 14
<b>description</b>	firebrick L 606mm W 313mm H 15mm mounting pos. lower Qty 2 pcs delivery freight forwarding company only		
<b>For models:</b>	KCK65/65		

1



<b>Part No.</b>	850095	<b>Ref. No.</b>	Bigou Z4 BJ04
<b>description</b>	firebrick L 625mm W 425mm H 15mm delivery freight forwarding company only		
<b>For models:</b>	BJ60/60		

1



<b>Part No.</b>	850087	<b>Ref. No.</b>	K105/65 14
<b>description</b>	firebrick L 625mm W 500mm H 15mm mounting pos. lower delivery freight forwarding company only		
<b>For models:</b>	KCK105/65		

1



<b>Part No.</b>	850085	<b>Ref. No.</b>	KCK65/65 R2
<b>description</b>	firebrick L 630mm W 160mm H 15mm with lamp duct mounting pos. side part left delivery freight forwarding company only		
<b>For models:</b>	KCK65/65		

1



<b>Part No.</b>	850084	<b>Ref. No.</b>	KCK65/65 R5
<b>description</b>	firebrick L 630mm W 160mm H 15mm with lamp duct mounting pos. side part right delivery freight forwarding company only		
<b>For models:</b>	KCK65/65		

1



<b>Part No.</b>	850086	<b>Ref. No.</b>	KCK65/65 R3
<b>description</b>	firebrick L 645mm W 160mm H 15mm mounting pos. side part at the back delivery freight forwarding company only		
<b>For models:</b>	KCK65/65		



1

<b>Part No.</b>	850088	<b>Ref. No.</b>	KCK65/105 R4
<b>description</b>	firebrick L 645mm W 520mm H 15mm mounting pos. upper delivery freight forwarding company only		
<b>For models:</b>	KCK65/105		



1

<b>Part No.</b>	850123	<b>Ref. No.</b>	KCK65/65 R4
<b>description</b>	firebrick L 645mm W 640mm H 15mm mounting pos. upper delivery freight forwarding company only		
<b>For models:</b>	KCK65/65		

### doors



1

<b>Part No.</b>	693368	<b>Ref. No.</b>	65/65Z2 K65/65 02
<b>description</b>	bush for door		

## knobs

### universal knobs



1

<b>Part No.</b>	110253	<b>Ref. No.</b>	40/60Z13
<b>description</b>	knob switch zero mark t.max. °C ø 50mm shaft ø 6x4.6mm shaft flat upper black		

### producer-specific knobs

#### FORNITALIA



1

<b>Part No.</b>	111742	<b>Ref. No.</b>	65/65Z13
<b>description</b>	knob potentiometer ø 78mm shaft ø 6x4.6mm shaft flat upper black		



1

<b>Part No.</b>	111740	<b>Ref. No.</b>	40/60Z15 BJ15
<b>description</b>	knob thermostat t.max. 450°C ø 49mm shaft ø 6x4.6mm shaft flat upper black temperature range 85-450°C rotation 270°		

## handles and hand wheels

### cone handles



1

<b>Part No.</b>	693370	<b>Ref. No.</b>	65/65Z17
<b>description</b>	cone handle thread M12x1.5 thread L 12.5mm		

## filters

### device filters

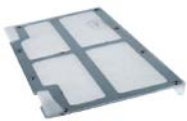

1

<b>Part No.</b>	693373	<b>Ref. No.</b>	65/65Z21 K65/65 21
<b>description</b>	filter		





## springs

## torsion springs



1

<b>Part No.</b>	693369	<b>Ref. No.</b>	65/65Z1 B65/65 01
<b>description</b>	torsion spring $\varnothing$ 22mm L2 51mm wire gauge $\varnothing$ 3.7mm L1 38mm L3 15mm		

**GASTRO**PARTS.COM

