



GASTROPARTS

Forcar

- [EN]** Equipment
- [DE]** Geräte
- [ES]** Aparatos
- [FR]** Équipement
- [IT]** Attrezzature
- [PL]** Urządzenia
- [RU]** Оборудование

✉ gastroparts@gastroparts.com

☎ +48 56 657 00 66

📘 fb.com/gastroparts.global

GASTROPARTS.COM





heating elements

heating elements for bain maries

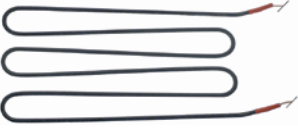
			
Part No.	417748	Ref. No.	SL0006
description	heating element 1200W 230V heating circuits 1 L 365mm W 190mm connection cable 500mm tube ø 6.3mm		
For models:	BM11, BM21, BM31, BMV11, BMV21, BMV31, CT1758TD, CT1760TD, CT1765, CT1765A700, CT1766, CT1766A700, CT1770, CT1770A700, CT1771, CT1771A700		

heating elements for refrigeration

heating elements for defrosting

			
Part No.	420150	Ref. No.	GN650BT. 01 RC0136
description	heating element 400W 230V L 290mm W 75mm H 90mm L1 60mm L2 230mm W1 16mm W2 43mm connection spate terminal M4 cable length 1200mm tube ø 10mm refrigeration for evaporator		
For models:	GN650BT, GN650BTG, GN650BTM, GN650TN, GN650TNG, GN650TNM		

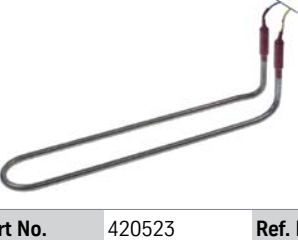
			
Part No.	420523	Ref. No.	RC0234
description	heating element 450W 220V L 400mm W 75mm H 135mm cable length 1480mm tube ø 9.6mm		

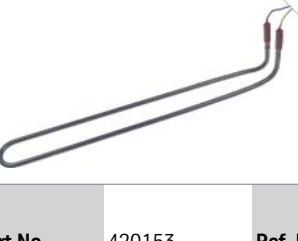
			
Part No.	420153	Ref. No.	GN140BT.02 GN1410BT.01 PA800BT.01 RC0062
description	heating element 700W L 590mm W 75mm H 115mm L1 60mm L2 530mm W1 13.5mm W2 48mm connection spate terminal M4 cable length 1700mm tube ø 10mm immersion heater refrigeration		
For models:	GE800BT, GN1410BT, GN1410BTM, GN1410TN, GN1410TNG, GN1410TNM, PA800BT, PA800TN		

immersion heating elements

with expansion flange 70 x 18mm

			
Part No.	420058	Ref. No.	SL0560
description	heating element 1950W 230V heating circuits 1 flange 70x18mm L 238mm W 64mm connection male faston 6.3mm tube ø 8.5mm		

			
Part No.	417618	Ref. No.	SL0004
description	heating element 2000W		
For models:	BM1780, BM1782, BM1784, BM1786, CL2772, CL2774, CL2774W, CL2777, CL2777W, CL2778, CL2778W, CS1751, CS1753, CS1755, CT1756, CT1758, CT1760, CT1762, DC1703, DC1704, ELC2828, ELC2828W, ELC2832, ELC2832W, ELC2834, ELC2834W, ELS2830		

switches and momentary switches

rocker/momentary rocker switches

<h4>30x22mm</h4>			
			
Part No.	347791	Ref. No.	S900.01 SL0621
description	rocker switch mounting measurements 30x22mm green 2NO 230V 20A illuminated 0-I connection male faston 6.3mm ambient temperature max. 125/55°C protection IP65 with rubber collar		
For models:	BC2PS, BC3PS, BI4719, BM11, BM1780, BM1782, BM1784, BM1786, BM21, BM31, BMS1781, BMS1783, BMS1785, BMV11, BMV21, BMV31, CA1439R, CA1439RG, CA1440AC, CA1440ACG, CAR2779, CAR2780, CAR2780BT, CL2772, CL2774, CL2774W, CL2775, CL2775W, CL2776, CL2776W, CL2777, CL2777W, CL2778, CL2778W, CL2781, CL2781W, CLR2782, CLR2782W, CLR2784, CLR2786, CLR2786W, CLR2787, CLR2787BT, CLR2787BTW, CLR2787W, CLR2788, CLR2788BT, CLR2788BTW, CLR2788W, CS1751...(Other models you can see in the webshop)		



EKTRON

refrigeration controllers

built-in version



1

Part No.	378034	Ref. No.	CO0862 SL0531
description	electronic controller EKTRON type REK31ED-0021 mounting measurements 71x29mm 230V voltage AC NTC/PTC relay outputs 1 CO-8A(4) NTC/PTC NTC/PTC built-in depth 71mm defr. funct. yes -50 up to +95°C display 3 digits		
For models:	CA1439RG, CAR2779, CAR2780, CAR2780BT, CLR2782, CLR2782W, CLR2786, CLR2786W, CLR2787, CLR2787BT, CLR2787BTW, CLR2787W, CLR2788, CLR2788BT, CLR2788BTW, CLR2788W, ELR2825, ELR2825W, ELR2826, ELR2826W, ELR2827, ELR2827W, ELS2830, GN1200BT, GN1200TN, GN600BT, GN600TN, GNB1200BT, GNB1200TN, PS200, PS300, PS900, RI330, RI380, S900, S901, S902, S903, S903PZ, S903TOP, SNACK340, SNACK400BT, SNACK400TN, SNACK638, SS45		
accessories for	378034		
	Part No.	379053	Ref. No. —
	temperature probe PTC 1kOhm cable PVC probe -50 up to +150°C cable -10 up to 100°C probe ø6x30mm cable length 3m without screw connection 2-wire		
	Part No.	379782	Ref. No. —
	temperature probe PTC 1kOhm cable thermoplastic probe -50 up to +150°C cable -40 up to +110°C probe ø6x14mm cable length 3m 2-wire resistor 1kOhm		



1

Part No.	378118	Ref. No.	CO0019
description	electronic controller EKTRON type REK33-1021 mounting measurements 71x29mm 230V voltage AC PTC relay outputs 3 NO-16A NO-8A(4) NO-8A(4) PTC PTC built-in depth 71mm -50 up to +95°C display 3½ digits		
accessories for	378118		
	Part No.	379052	Ref. No. —
	temperature probe PTC 1kOhm cable silicone probe -50 up to +150°C cable -50 up to +180°C probe ø6x40mm cable length 1.5m without screw connection 2-wire		

probes

universal probes

temperature probes

1			
Part No.	379161	Ref. No.	RC0321 S900.32
description	temperature probe NTC 10kOhm cable thermoplastic probe -40 up to +110°C cable -40 up to +110°C probe ø6x14mm cable length 3m without screw connection 2-wire		
For models:	BC2PS, BC3PS, EF400, EF600, ER400, ER400G, ER600, ER600G, GN1200BT, GN1200TN, GN600BT, GN600TN, GNB1200BT, GNB1200TN, PS200, PS300, PS900, RI330, RI380, S900, S901, S901TOP, S902, S902STD, S903, S903PZ, S903TOP, SNACK400BT, SNACK400TN, SS45, SS45BT		

electronics

PCBs

1			
Part No.	402813	Ref. No.	HR600.07 RC0419
description	display PCB for fridge L 150mm W 37mm suitable for ER400/600 with potentiometer with thermostat type LTC-20HT		
For models:	ER400, ER400G, ER600, ER600G		

1			
Part No.	402812	Ref. No.	HF600.07 RC0429
description	display PCB refrigerator EF400/600 L 150mm W 38mm with potentiometer with thermostat type LTC-24HT		
For models:	EF600		

1 electric components



compressors

ACC/ZEL

R134A

LBP monophase

Lower evaporation temperature below -20°C



1

Part No.	605126	Ref. No.	RC0047 S900.41
description	compressor coolant R134a type OF1350A 220-240V 50Hz LBPkg 1/4HP power input 158W cylinder capacity 7.5cm ³ RSIR H 183mmWWWWWWWW ZEL		
For models:	BC3PS, ER600, ER600G, GN1200DT, GN1200DTV, GN2100TN, GN2100TNG, GN2200TN, GN3100TN, GN3100TNG, GN600DTV, GN600TN, GNV1200DT, GNV600DT, PA2100TN, PS200, PS300, PS900, PZ2600TN, PZ2610TN, S900, S901, S901TOP, S902, S902STD, SNACK176, SNACK2100TN, SNACK251, SNACK290, SNACK3100TN, SNACK340, SNACK400STN, SNACK400TN, U-GN2100TN, U-GN3100TN, VRX2000-330, VRX2000-380		

EMBRACO / ASPERA

R134A

HMBP monophase

High/Medium evaporation temperature above -20/-15 °C



1

Part No.	605244	Ref. No.	GN1410TN. 11 NE1130Z RC0564
description	compressor coolant R134a type FFI12HBK 220-240V 50Hz HMBP 10.8kg 1/3HP cylinder capacity 11.15cm ³ CSIR H 180mm 223W 304W 405W 527W 671W 836W 1024W 1236W 1471W test method EN 12900		
For models:	EF600, GN1200TN, GN1410TN, GN1410TNG, GN1410TNM, SNACK638, SS45BT		

fans

axial fans

import





1

Part No.	601604 ¹	Ref. No.	RC0011 RC0654 S900.34
description	axial fan L 119mm W 119mm H 38mm 230VAC 50/60Hz 17/15W bearing slide bearing manuf. no. AA1282HS-AT connection cable 300mm fan wheel ø 110mm temp.-resist. 70°C input current 0.1A airflow 130m ³ /h 2600rpm		
For models:	BC2PS, BC3PS, EF400, EF600, ER400, ER400G, ER600, ER600G, GN1200BT, GN1200DT, GN1200TN, GN600BT, GN600TN, GNB1200BT, GNB1200TN, GNB600BT, PS200, PS300, PS900, RI330, RI380, S900, S901, S902, S902STD, S903, S903PZ, S903TOP, SNACK176, SNACK251, SNACK290, SNACK340, SNACK400BT, SNACK400SBT, SNACK400STN, SNACK400TN, SNACK638, SS45, SS45BT, VRX1200-330, VRX1200-380, VRX1400-330, VRX1500-330, VRX1500-380, VRX1800-330, VRX1800-380, VRX2000-330, VRX2000-380		

¹with slide bearings

1

Part No.	601055 ¹	Ref. No.	GN2100TN.35
description	axial fan L 92mm W 92mm H 25mm 230VAC 50/60Hz 14.5/14W bearing ball bearing connection male faston 2.8mm metal ADDA fan wheel ø 85mm temp.-resist. 70°C		
For models:	GN2100BT, GN2100TN, GN2100TNG, GN2200TN, GN3100BT, GN3100TN, GN3100TNG, GN4100BT, GN4100TN, GN4100TNG, GN4200TN, PA2100TN, PA3100TN, PZ2600TN, PZ2610TN, PZ3600TN, SNACK2100TN, SNACK3100TN, SNACK340, SNACK4100TN, SNACK638		
accessories for	601055		
	Part No.	550898	Ref. No. —
	connecting cable cable length 2000mm connection F 2.8 connection distance 7.9mm for axial flow fan		
	Part No.	691103	Ref. No. —
	guard ø 90mm mounting distance 83mm for axial fan 92mm		

¹with ball bearings

refrigeration fans



refrigeration motors universal

ebm-papst

miscellaneous



1

Part No.	601783	Ref. No.	GN650TN.34 S900.37
description	fan motor 10W 230V 50/60Hz L3 87mm W 67mm cable length 400mm 1300rpm ebm-papst M4Q045-CA03-51/C18 3 mounting options bearing slide bearing for refrigerated counters		
For models:	GN1200BT, GN1200DT, GN1200DTV, GN1200TN, GN1410BT, GN1410BTM, GN1410TN, GN1410TNG, GN1410TNM, GN2100BT, GN2100TN, GN2100TNG, GN2200TN, GN3100BT, GN3100TN, GN3100TNG, GN3200BT, GN4100BT, GN4100TN, GN4100TNG, GN4200TN, GN600DTV, GN600TN, GN650BT, GN650BTG, GN650BTM, GN650TN, GN650TNG, GN650TNM, GNV1200DT, GNV600DT, PA2100TN, PA3100TN, PA800TN, PS200, PS300, PS900, PZ2600TN, PZ2610TN, PZ3600TN, S900, S901TOP, S902STD, S903, S903PZ, S903TOP, SNACK2100TN, SNACK3100TN, SNACK340, SNACK400SBT... (Other models you can see in the webshop)		
spare parts for	601783		
	Part No.	601413	Ref. No. —
accessories for	601783		
	Part No.	601385	Ref. No. —
	fan wheel sucking ø 172mm fan wheel mounting 25.4mm blade angle 34° W 42mm aluminium		

accessories

fan guards





1

Part No.	601738	Ref. No.	RC0219 S900.38
description	guard for fan wheel ø 170mm ø 216mm H 30mm mounting distance 1 224 up to 254mm mounting distance 2 94.5mm		
For models:	PS200, PS900, S901TOP, S902STD, SNACK3100TN, SNACK638, SS45BT, U-GN2100TN, U-GN3100TN, U-GN4100TN		

cooling motors (complete)



1

Part No.	601739	Ref. No.	GN650BT. 11 RC0229
description	fan 230V 10W 50Hz fan wheel ø 230mm shaft L 20mm L 86mm W 67mm blade angle 34° connection spate terminal M4 cable length 1100mm		
For models:	GE800BT, GN1200BT, GN1200DT, GN1200DTV, GN1200TN, GN1410BT, GN1410BTM, GN1410TN, GN1410TNG, GN1410TNM, GN600BT, GN600DTV, GN600TN, GN650BT, GN650BTG, GN650BTM, GN650TN, GN650TNG, GN650TNM, GNB1200BT, GNB1200TN, GNB600BT, GNV1200DT, GNV600DT, PA800BT, PA800TN, PS200, PS300, PS900, S900, S901, S902, S903, S903PZ, S903TOP, SNACK340, SNACK400BT, SNACK400TN, SNACK638, SS45		
spare parts for	601739		
	Part No.	601172	Ref. No. —
	fan wheel sucking ø 230mm fan wheel mounting 25.4mm blade angle 34° W 50mm aluminium		
	Part No.	601757	Ref. No. —
	fan motor 10W 230V 50/60Hz L1 43.5mm L3 82mm W 67mm cable length 1500mm 1300/1550rpm ebm-papst M4Q045-CA03-75 5 mounting options bearing slide bearing		
	Part No.	601783	Ref. No. GN650TN. 34 S900.37
	fan motor 10W 230V 50/60Hz L3 87mm W 67mm cable length 400mm 1300rpm ebm-papst M4Q045-CA03-51/C18 3 mounting options bearing slide bearing for refrigerated counters		



1

Part No.	602042	Ref. No.	RC1184
description	fan 240V 7.5W 50/60Hz fan wheel ø 100mm mounting distance 95mm ø 150mm		



electric accessories

cables

power supply cables



1

Part No.	551085	Ref. No.	SL0130
description	cable CEE7/7 type E+F 3-pole contacts P+N+E 1.5mm ² max. 16A max 230V 2m with plug H05VV-F 3G1.5		
For models:	BI4719, BM11, BM1780, BM1782, BM1784, BM1786, BM21, BM31, BMS1781, BMS1783, BMS1785, BMV11, BMV21, BMV31, CA1439R, CA1439RG, CA1440AC, CA1440ACG, CAR2779, CAR2780, CAR2780BT, CL2772, CL2774, CL2774W, CL2775, CL2775W, CL2776, CL2776W, CL2777, CL2777W, CL2778, CL2778W, CL2781, CL2781W, CLR2782, CLR2782W, CLR2784, CLR2786, CLR2786W, CLR2787, CLR2787BT, CLR2787BTW, CLR2787W, CLR2788, CLR2788BT, CLR2788BTW, CLR2788W, CS1751, CS1753, CS1755... (Other models you can see in the webshop)		

terminal boxes



1

Part No.	551214	Ref. No.	S900.48
description	terminal box 4-pole L 90mm W 52mm H 28mm with strain relief Qty 1 pcs		
For models:	PS200, PS300, PS900, S900, S901TOP, S902STD, S903, S903PZ, S903TOP, SNACK176, SNACK251, SNACK290, SS45BT, VRX1200-330, VRX1200-380, VRX1400-330, VRX1500-330, VRX1500-380, VRX1800-330, VRX1800-380, VRX2000-330, VRX2000-380		



1

Part No.	551090	Ref. No.	GN650TN. 16 RC0235
description	terminal box 5-pole L 95mm W 63mm H 27mm		
For models:	EF400, EF600, ER400, ER400G, ER600, ER600G, GE800BT, GN1200BT, GN1200DT, GN1200DTV, GN1200TN, GN1410BT, GN1410BTM, GN1410TN, GN1410TNG, GN1410TNM, GN2100BT, GN2100TN, GN2100TNG, GN2200TN, GN3100BT, GN3100TN, GN3100TNG, GN3200BT, GN4100BT, GN4100TN, GN4100TNG, GN4200TN, GN600BT, GN600DTV, GN600TN, GN650BT, GN650BTG, GN650BTM, GN650TN, GN650TNG, GN650TNM, GNB1200BT, GNB1200TN, GNB600BT, GNV1200DT, GNV600DT, PA2100TN, PA3100TN, PA800BT, PA800TN, PZ2600TN, PZ2610TN, RI330, RI380...(Other models you can see in the webshop)		

equipment-specific units

for fridges

housing and bezels

caps



1

Part No.	692372	Ref. No.	PS900.03 RC0736
description	cap grey ø 16.5mm mounting ø 12.5mm H 7mm Qty 1 pcs		
For models:	PS200, PS300, PS900, RI330, RI380, S900, S901, S901TOP, S902, S902STD, S903, S903PZ, S903TOP, SNACK340, SNACK400SBT, SNACK400STN, SNACK638, SS45, SS45BT, VRX1200-330, VRX1200-380, VRX1400-330, VRX1500-330, VRX1500-380, VRX1800-330, VRX1800-380, VRX2000-330, VRX2000-380		

miscellaneous



1

Part No.	696413	Ref. No.	GN650TN. 01 RC0316
description	screw thread M6 L 18mm		
For models:	GN1200BT, GN1200TN, GN1410BT, GN1410BTM, GN1410TN, GN1410TNG, GN1410TNM, GN600BT, GN600TN, GN650BT, GN650BTG, GN650BTM, GN650TN, GN650TNG, GN650TNM, GNB600BT, SNACK400SBT, SNACK400STN, SNACK400TN		

for refrigerated counters

spare parts and accessories



1

Part No.	697917	Ref. No.	C00140 S900.29	
description	fixing plate with opposite support thread M5			
For models:	PS200, PS300, S900, S902STD, S903			
accessories for	697917			
	Part No.	697916	Ref. No.	C00139 S900.28
	screw bolt with nut L 8mm thread M5 ø 6mm			





1

Part No.	697916	Ref. No.	C00139 S900.28
description	screw bolt with nut L 8mm thread M5 ø 6mm		
For models:	PS200, PS300, PZ2610TN, S900, S902STD, S903		
accessories for	697916		
	Part No.	697917	Ref. No. C00140 S900.29
fixing plate with opposite support thread M5			

for saladettes

spare parts and accessories



1

Part No.	697917	Ref. No.	C00140 S900.29
description	fixing plate with opposite support thread M5		
For models:	PS200, PS300, S900, S902STD, S903		
accessories for	697917		
	Part No.	697916	Ref. No. C00139 S900.28
screw bolt with nut L 8mm thread M5 ø 6mm			



1

Part No.	697916	Ref. No.	C00139 S900.28
description	screw bolt with nut L 8mm thread M5 ø 6mm		
For models:	PS200, PS300, PZ2610TN, S900, S902STD, S903		
accessories for	697916		
	Part No.	697917	Ref. No. C00140 S900.29
fixing plate with opposite support thread M5			

for dishwashers

hood mechanics for dishwashers

rollers



1

Part No.	694774	Ref. No.	RC1207
description	roller for vitrine L 42mm		

locks

locking devices

producer-specific

FORCAR





1

Part No.	692338	Ref. No.	RC0725
description	hook H 25mm L 44mm W 30mm hole ø 3.5mm for catch		



1

Part No.	692188	Ref. No.	RC0128
description	key cylinder with lever ø 17.3mm rotation 90° cam length 49mm cam width 13mm		
For models:	GN1200BT, GN1200TN, GN600BT, GN600TN, GNB1200BT, GNB1200TN, SNACK340, SNACK400BT, SNACK400TN, SNACK638		
accessories for	692188		
	Part No.	692338	Ref. No. RC0725
hook H 25mm L 44mm W 30mm hole ø 3.5mm for catch			



1

Part No.	692148	Ref. No.	GN2100TN.02 GN650TN.86 RC0243 RC0425
description	key cylinder with lever ø 17.5mm		
For models:	EF400, EF600, ER400, ER400G, ER600, ER600G, GE800BT, GN1200BT, GN1200DT, GN1200DTV, GN1200TN, GN1410BT, GN1410BTM, GN1410TN, GN1410TNG, GN1410TNM, GN2100BT, GN2100TN, GN2100TNG, GN2200TN, GN3100BT, GN3100TN, GN3100TNG, GN3200BT, GN4100BT, GN4100TN, GN4100TNG, GN4200TN, GN600BT, GN600DTV, GN600TN, GN650BT, GN650BTG, GN650BTM, GN650TN, GN650TNG, GN650TNM, GNB600BT, GNV1200DT, GNV600DT, PA2100TN, PA3100TN, PA800BT, PA800TN, PZ2600TN, PZ2610TN, PZ3600TN, SNACK176, SNACK2100TN, SNACK251...(Other models you can see in the webshop)		



hinges

spring assisted hinges

universal

INTERKLIMAT

hinges



1

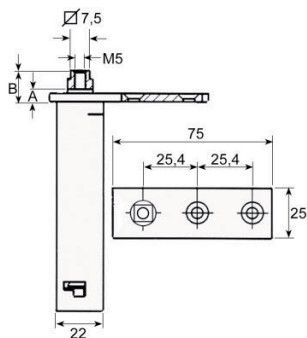

Part No.	690622	Ref. No.	GN650TN. 14 RC0089
description	spring assisted hinge series 28L mounting pos. left/right L 75mm W 25mm H 103mm A 13mm B 18mm mounting measurements 22x22mm intake 7.5x7.5 refrigeration units		
For models:	GE800BT, GN1200BT, GN1200DT, GN1200DTV, GN1200TN, GN1410BT, GN1410BTM, GN1410TN, GN1410TNG, GN1410TNM, GN2100BT, GN2100TN, GN2100TNG, GN2200TN, GN3100BT, GN3100TN, GN3100TNG, GN3200BT, GN4100BT, GN4100TN, GN4100TNG, GN4200TN, GN600BT, GN600DTV, GN600TN, GN650BT, GN650BTG, GN650BTM, GN650TN, GN650TNG, GN650TNM, GNB1200BT, GNB1200TN, GNB600BT, GNV1200DT, GNV600DT, PA2100TN, PA3100TN, PA800BT, PA800TN, PZ2600TN, PZ2610TN, SNACK2100TN, SNACK3100TN, SNACK340, SNACK400BT, SNACK400SBT, SNACK400STN, SNACK400TN, SNACK4100TN... (Other models you can see in the webshop)		

door bearing



1

Part No.	700975	Ref. No.	HF600.19 RC0536
description	bolt L 20mm mounting pos. upper/lower thread M5 ø 7mm for hinge		
For models:	EF400, EF600, ER400, ER400G, ER600, ER600G		

	1		
Part No.	701257	Ref. No.	S900.06
description	bolt L 25mm mounting pos. upper thread M5 ø 7mm complete for door hinge Qty 1 pcs		
For models:	GE800BT, GN1200BT, GN1200DT, GN1200DTV, GN1200TN, GN1410BT, GN1410BTM, GN1410TN, GN1410TNG, GN1410TNM, GN600BT, GN600DTV, GN600TN, GN650BT, GN650BTM, GN650TN, GN650TNG, GN650TNM, GNB600BT, GNV1200DT, PA800BT, PA800TN, PS200, PS300, PS900, S900, S901TOP, S902STD, S903, S903PZ, S903TOP, SNACK400TN, SS45BT		

	1		
Part No.	701032	Ref. No.	GN2100TN.03 GN2100TN.05 GN2100TN.06 RC0175 RC0652
description	bolt L 32.4mm mounting pos. upper thread M8x1.25 ø 5/7mm with nut for door		
For models:	GN2100BT, GN2100TN, GN2100TNG, GN2200TN, GN3100BT, GN3100TN, GN3100TNG, GN4100BT, GN4100TN, GN4100TNG, GN4200TN, PA2100TN, PA3100TN, PS200, PS300, PS900, PZ2600TN, PZ2610TN, PZ3600TN, S900, S901, S902, S903, S903PZ, S903TOP, SNACK2100TN, SNACK3100TN, SNACK4100TN, SS45, U-GN2100TN, U-GN3100TN, U-GN4100TN		

	1		
Part No.	700976	Ref. No.	GN2100TN. 070 RC0176
description	bush L 20mm ø 9mm ID ø 7.1mm for hinge		
For models:	PS200, PS300, PS900, S900, S901, S902, S903, S903PZ, S903TOP, SNACK340, SNACK638, SS45		

	1		
Part No.	692258	Ref. No.	S900.55
description	hinge L 30mm W 30mm H 45mm mounting pos. bottom left thickness 3mm		





 <p>1</p>			
Part No.	692374	Ref. No.	S900.05
description	hinge L 30mm W 30mm H 45mm mounting pos. bottom right thickness 3mm Qty 1 pcs		
For models:	PS200, PS300, PS900, S900, S901TOP, S902STD, S903, S903PZ, S903TOP, SS45BT		

 <p>2</p>			
Part No.	700974	Ref. No.	HF600.08 RC0535
description	hinge L 49mm W 40mm H 43mm mounting pos. lower thickness 4mm		
For models:	EF400, EF600, ER400, ER400G, ER600, ER600G		

 <p>1</p>			
Part No.	700973	Ref. No.	HF600.01 RC0534
description	hinge L 51mm W 40mm mounting pos. upper thickness 3mm		
For models:	EF400, EF600, ER400, ER400G, ER600, ER600G		

 <p>1</p>			
Part No.	701034	Ref. No.	RC0064
description	hinge camp mounting pos. bottom right L 86mm W 46mm H 17mm hole distance 25mm shaft diameter 8x8mm		

 <p>1</p>			
Part No.	701033	Ref. No.	GN2100TN. 28 RC0063
description	hinge camp mounting pos. left bottom L 86mm W 44mm H 19mm hole distance 25mm shaft diameter 8x8mm		

 <p>1</p>			
Part No.	701035	Ref. No.	GN650TN. 51 RC0088
description	hinge camp mounting pos. upper left L 100mm W 63mm H 30mm hole distance 60mm shaft diameter 8x8mm		

 <p>1</p>			
Part No.	701038	Ref. No.	GN650TN. 15 RC0087
description	hinge camp mounting pos. upper right L 99mm W 64mm H 30mm hole distance 60mm shaft diameter 8x8mm		
For models:	GE800BT, GN1200BT, GN1200DT, GN1200DTV, GN1200TN, GN1410BT, GN1410BTM, GN1410TN, GN1410TNG, GN1410TNM, GN600BT, GN600DTV, GN600TN, GN650BT, GN650BTM, GN650TN, GN650TNM, GNB1200BT, GNB1200TN, GNB600BT, GNV1200DT, PA800BT, PA800TN, SNACK400BT, SNACK400SBT, SNACK400STN, SNACK400TN		

equipment feet and end caps

screw-in feet

 <p>1</p>			
Part No.	700972	Ref. No.	S900.13 SL0494
description	equipment foot thread M10 thread L 16mm ø 29mm H 11.5mm Qty 1 pcs for fridge		
For models:	BM11, BM21, BM31, CA1439B, CA1439BG, CA1440B, CA1440BG, EF400, EF600, ER400, ER400G, ER600, ER600G, GE800BT, GN2100BT, GN2100TN, GN2100TNG, GN2200TN, GN3100BT, GN3200BT, GN4100BT, GN4100TN, GN4100TNG, GN4200TN, GN650BT, GN650BTG, GN650BTM, GN650TN, GN650TNG, GN650TNM, PA2100TN, PA3100TN, PA800BT, PA800TN, PS200, PS300, PS900, PZ2600TN, S900, S901, S901TOP, S902, S902STD, S903, S903PZ, S903TOP, SNACK2100TN, SNACK340, SNACK4100TN, SNACK638... (Other models you can see in the webshop)		

baskets

warewashing baskets

accessories

cutlery inserts

 <p>1</p>			
Part No.	972032	Ref. No.	CP8
description	cutlery insert L 430mm W 205mm ømm H 150mm		







shelves and shelf rails

grates

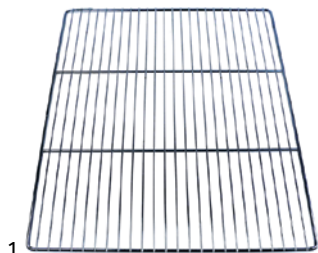
universal

without upstand



Part No.	970123	Ref. No.	GN650TN. 08 GRI21
description	grate W 650mm D 530mm GN 2/1 stainless steel wire gauge frame 7.8mm lengthwise wires gauge 3.8mm crossing wires 2 suitable for refrigerator		
For models:	GN1200DTV, GN1410BT, GN1410BTM, GN1410TN, GN1410TNG, GN1410TNM, GN600DTV, GN650BT, GN650BTG, GN650BTM, GN650TN, GN650TNG, GN650TNM, GNV1200DT, GNV600DT		
accessories for	970123		
	Part No.	Ref. No.	—
	690330		
description	rack L 1000mm W 22mm H 4mm aperture 3x8mm hole distance 12.5mm stainless steel		
	Part No.	Ref. No.	—
	694700		
description	shelf support L 31/28mm W 22mm H 18mm SS Qty 12 pcs		
	Part No.	Ref. No.	—
	694701		
description	shelf support L 31/28mm W 22mm H 17mm SS with hook Qty 12 pcs		

with upstand



Part No.	970772	Ref. No.	GRP600
description	grate W 650mm D 530mm GN 2/1 H 40mm plastic-coated steel with hinge camp crossing wires 4		

shelf rails and supports

producer-specific



Part No.	696443	Ref. No.	S900.10.1
description	pair of setting bar U-shape L 548mm W 20mm inner height 13mm mounting pos. left/right		

SHELVES AND SHELF RAILS/GASKETS FORCAR



Part No.	696388	Ref. No.	CG11 GN2100TN.31 S900.10
description	pair of setting bar U-shape L 550mm W 20mm H 17mm mounting pos. left/right		
For models:	GN2100BT, GN2100TN, GN2100TNG, GN2200TN, GN3100BT, GN3100TN, GN3100TNG, GN3200BT, GN4100BT, GN4100TN, GN4100TNG, GN4200TN, PS200, PS300, PS900, S900, S901, S901TOP, S902, S902STD, S903, S903PZ, S903TOP, SS45, SS45BT, U-GN2100TN, U-GN3100TN, U-GN4100TN		



Part No.	694507	Ref. No.	AG G350.08 RC0361
description	shelf support L 38/26mm W 22mm H 24mm SS Qty 4 pcs		
For models:	BC2PS, BC3PS, SNACK176, SNACK251, SNACK290, SNACK340, SNACK638		

gaskets

refrigeration gaskets

plug-in gaskets

profile 9153

We offer custom-made gaskets for this profile

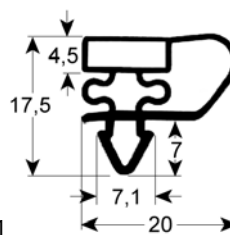

Part No.	902266	Ref. No.	N/A
description	refrigeration gasket profile 9153 Wmm L 2500mm		



profile 9150

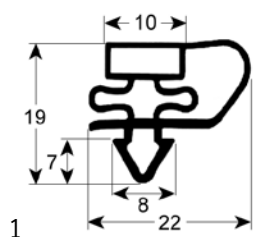

Part No.	901279	Ref. No.	RC0072 S900.08
description	refrigeration gasket profile 9150 W 395mm L 490mm plug size		
For models:	PS200, PS300, PS900, S900, S901, S901TOP, S902, S902STD, S903, S903PZ, S903TOP, SS45		

profile 9157

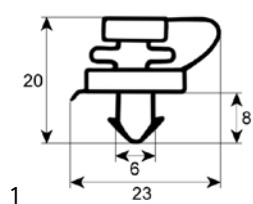

Part No.	901281	Ref. No.	HF400.03 RC0421
description	refrigeration gasket profile 9157 W 570mm L 1650mm plug size Qty 1		
For models:	EF400, ER400, ER400G		

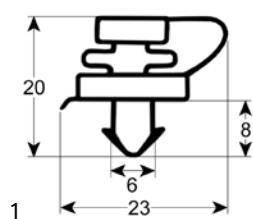

Part No.	901975	Ref. No.	RC0199 SNACK400TN.06
description	refrigeration gasket profile 9157 W 615mm L 1445mm plug size		
For models:	GN1200BT, GN1200DT, GN1200DTV, GN1200TN, GN600BT, GN600DTV, GN600TN, GNB600BT, GNV1200DT, SNACK400SBT, SNACK400STN, SNACK400TN		

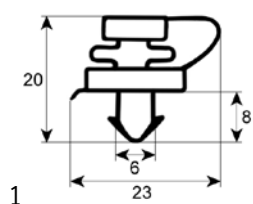

Part No.	901333	Ref. No.	GN650TN. 13 RC0153
description	refrigeration gasket profile 9157 W 695mm L 1477mm plug size L1 1467mm W1 685mm external size		
For models:	GE800BT, GN1410BT, GN1410TN, GN4100TN, GN4100TNG, GN4200TN, GN650BT, GN650BTG, GN650TN, PA800BT, PA800TN, PZ3600TN, SNACK4100TN		

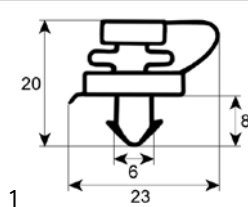

Part No.	901282	Ref. No.	HF600.06 RC0426
description	refrigeration gasket profile 9157 W 750mm L 1700mm plug size		
For models:	EF600, ER600, ER600G		

profile 9041

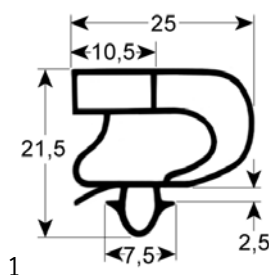

Part No.	901957	Ref. No.	GN2100TN. 33 RC0041
description	refrigeration gasket profile 9041 W 385mm L 595mm plug size		
For models:	GN2100BT, GN2100TN, GN2200TN, GN3100BT, GN3100TN, GN4100BT, GN4100TN, GN4200TN, SNACK2100TN, SNACK3100TN, SNACK4100TN		

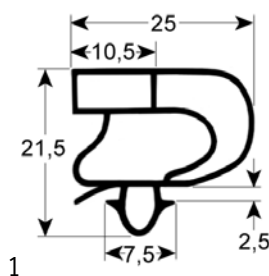

Part No.	901958	Ref. No.	PA2100TN. 9 RC0162
description	refrigeration gasket profile 9041 W 460mm L 592mm plug size		
For models:	PA2100TN, PA3100TN, PZ2600TN, PZ2610TN, PZ3600TN		

profile 9326

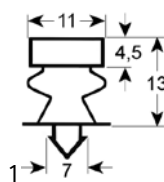

Part No.	901959	Ref. No.	RC0770
description	refrigeration gasket profile 9326 W 535mm L 1155mm plug size		



refrigeration cycle components

valves

Schrader valves

Schrader valves (complete)



Part No.	750101	Ref. No.	S900.42
description	Schrader valve complete connection 1/4" SAE L 130mm		

filter driers

miscellaneous



Part No.	750618	Ref. No.	GN1410TN.14
description	dryer size 15g ø 19mm L 114mm connection 2,7/6,5mm type XH9 Qty 1 pcs		
For models:	GE800BT, GN1200BT, GN1200DTV, GN1200TN, GN1410BT, GN1410BTM, GN1410TN, GN1410TNG, GN1410TNM, GN2100BT, GN2100TNG, GN3100BT, GN3200BT, GN4100BT, GN4100TNG, GN600BT, GN600TN, GN650BT, GN650BTG, GN650BTM, GN650TN, GN650TNG, GN650TNM, GNB600BT, GNV600DT, PA2100TN, PA3100TN, PA800BT, PA800TN, PZ2600TN, PZ3600TN, SNACK400SBT, SNACK400STN, SNACK400TN		



Part No.	750324	Ref. No.	RC0066 S900.44
description	dryer size 20g ø 23mm L 117mm connection 4,8/8,3mm		
For models:	GN1200BT, GN1200TN, GN2100TN, GN2200TN, GN3100TN, GN3100TNG, GN4100TN, GN4200TN, GN600BT, GN600TN, GNB1200BT, GNB1200TN, PS200, PS300, PS900, PZ2610TN, RI330, RI380, S900, S901, S901TOP, S902, S902STD, S903, S903PZ, S903TOP, SNACK2100TN, SNACK3100TN, SNACK340, SNACK400BT, SNACK400TN, SNACK4100TN, SNACK638, SS45, SS45BT, U-GN2100TN, U-GN3100TN, U-GN4100TN, VRX1200-330, VRX1200-380, VRX1400-330, VRX1500-330, VRX1500-380, VRX1800-330, VRX1800-380, VRX2000-330, VRX2000-380		



Part No.	750619	Ref. No.	RC0768
description	dryer size 30g ø 24mm L 140mm connection 2,6/6,5mm Qty 1 pcs		

refrigeration pipes

capillary pipes



Part No.	694442	Ref. No.	RC0523 S900.43
description	capillary pipe ID ø 1.15mm copper Qty 1m L 300mm refrigeration ED ø 2.1mm		
For models:	BC2PS, BC3PS, GN1200BT, GN1200TN, GN2100BT, GN2100TN, GN2100TNG, GN2200TN, GN3100BT, GN3100TN, GN3100TNG, GN3200BT, GN4100BT, GN4100TN, GN4100TNG, GN4200TN, GN600BT, GN600TN, GNB600BT, PA2100TN, PA3100TN, PS200, PS300, PS900, PZ2600TN, PZ2610TN, PZ3600TN, S900, S901TOP, S902STD, S903, S903PZ, S903TOP, SNACK2100TN, SNACK3100TN, SNACK340, SNACK400STN, SNACK400TN, SNACK4100TN, SNACK638, SS45BT, U-GN2100TN, U-GN3100TN, U-GN4100TN		



Part No.	694443	Ref. No.	GN1410BT.05
description	capillary pipe ID ø 1.4mm copper Qty 1m L 2500mm refrigeration ED ø 2.8mm		
For models:	GN1410BT, GN1410BTM		



1

Part No.	694444	Ref. No.	GN1410TN.13
description	capillary pipe ID ø 1.4mm copper Qty 1m L 3000mm refrigeration ED ø 2.8mm		
For models:	GN1410TN, GN1410TNG, GN1410TNM		

copper pipes uninsulated



1

Part No.	694452	Ref. No.	GN2100TN.09
description	refrigeration pipe copper ED ø 6mm L 0.5m Qty 1m for evaporator		
For models:	GN2100BT, GN2100TN, GN2100TNG, GN2200TN, GN3100BT, GN3100TN, GN3100TNG, GN3200BT, GN4100BT, GN4100TN, GN4100TNG, GN4200TN, PA2100TN, PA3100TN, PZ2600TN, PZ2610TN, PZ3600TN, U-GN2100TN, U-GN3100TN, U-GN4100TN		



1

Part No.	694441	Ref. No.	GN650TN.40
description	refrigeration pipe insulated copper ID ø 7mm ED ø 8mm L 1.8m suction line		
For models:	GE800BT, GN1410TN, GN1410TNG, GN1410TNM, GN650TN, GN650TNG, GN650TNM, PA800BT, PA800TN, SNACK400TN		

evaporators

for fridges

producer-specific



1

Part No.	750300	Ref. No.	RC0589
description	condenser L 170mm W 85mm H 180mm suitable for ER600		



1

Part No.	750294	Ref. No.	HR400.07 RC0605
description	evaporator for fridge ER400 L 1000mm W 440mm		
For models:	ER400, ER400G		



1

Part No.	750295	Ref. No.	HR600.04 RC0606
description	evaporator for fridge ER600 L 1000mm W 580mm		
For models:	ER600, ER600G		



1

Part No.	750410	Ref. No.	GN650TN. 21 RC0319
description	evaporator L 216mm W 130mm H 200mm total length 298mm overall width 130mm overall height 220mm		
For models:	GN650TN, GN650TNG, GN650TNM		



1



Part No.	750317	Ref. No.	GN650BT. 02 RC0283
description	evaporator L 298mm W 152mm H 220mm total length 518mm for fridge		
For models:	GN650BT, GN650BTG, GN650BTM		

1



Part No.	750322	Ref. No.	GN2100TN.18 GN2100TN21 RC0285
description	evaporator L 505mm W 95mm H 265mm suitable for ER400/ER400G/ER400SS		
For models:	GN2100BT, GN2100TN, GN2100TNG, GN2200TN, GN3100BT, GN3100TN, GN3100TNG, GN4100BT, GN4100TN, GN4100TNG, GN4200TN, PA2100TN, PA3100TN, PZ2600TN, PZ2610TN, PZ3600TN, SNACK2100TN, SNACK3100TN, SNACK4100TN		

1



Part No.	750318	Ref. No.	GN1410TN. 01 RC0320
description	evaporator L 595mm W 130mm H 220mm for fridge		
For models:	GN1410TN, GN1410TNG, GN1410TNM		

1

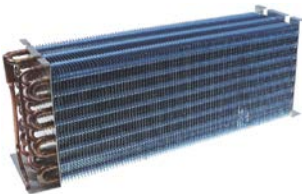

Part No.	750321	Ref. No.	GN1410BT. 08 RC0221
description	evaporator L 595mm W 130mm H 220mm for fridge		
For models:	GN1410BT, GN1410BTM		

condensers

filters

1



Part No.	694587	Ref. No.	S900.04
description	air filter for condenser L 218mm W 194mm thickness 6mm Qty 1 pcs		
For models:	PS200, PS900, S900, S901TOP, S902STD, SS45BT		

1



Part No.	694446	Ref. No.	RC0122 S903.08
description	air filter for condenser L 218mm W 205mm thickness 6mm		
For models:	GN1200BT, GN1200DT, GN1200DTV, GN1200TN, GN600BT, GN600DTV, GN600TN, GN650TN, GN650TNG, GN650TNM, GNB1200BT, GNB1200TN, GNV1200DT, GNV600DT, PA800TN, PS200, PS300, PS900, S900, S901, S902, S903, S903PZ, S903TOP, SNACK400BT, SNACK400SBT, SNACK400STN, SNACK400TN, SS45		

1



Part No.	694445	Ref. No.	GN1410BT. 07 RC0556
description	air filter for condenser L 245mm W 215mm thickness 6mm		
For models:	GN1410BT, GN1410BTM		

1



Part No.	694447	Ref. No.	GN2100TN.34
description	air filter for condenser W 175mm H 228mm thickness 6mm		
For models:	GN2100TN, GN2200TN, GN3100TN, GN4100TN, GN4200TN, SNACK2100TN, SNACK3100TN, SNACK4100TN		

1

Part No.	694860	Ref. No.	RC1340
description	air filter L 218mm W 175mm thickness 4.5mm		

condensers

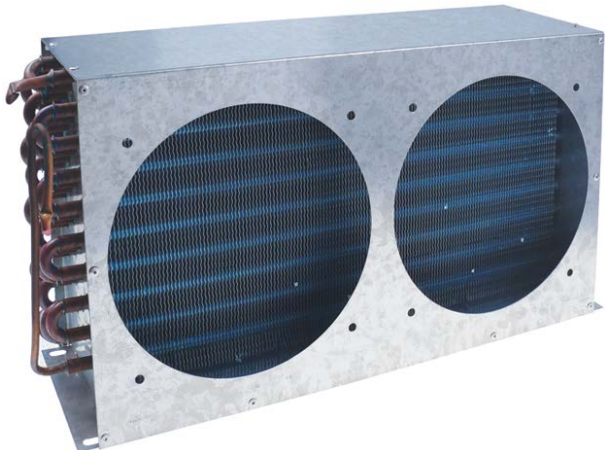

1

Part No.	750323	Ref. No.	GN1410BT. 06 RC0292
description	condenser for fridge W 140mm H 271mm L 500mm		
For models:	GN1410BT, GN1410BTM		

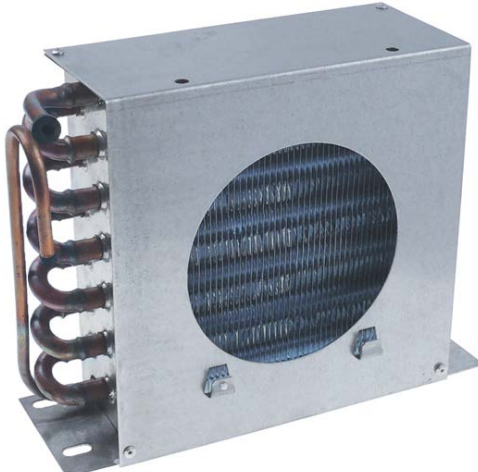

1

Part No.	750319	Ref. No.	RC0201 VRX.11
description	condenser for pizza table W 228mm D 77mm H 179mm		
For models:	VRX1200-330, VRX1200-380, VRX1400-330, VRX1500-330, VRX1500-380, VRX1800-330, VRX1800-380, VRX2000-330, VRX2000-380		



1

Part No.	750320	Ref. No.	GN2100TN. 08 RC0286
description	condenser for pizza table W 280mm D 190mm H 230mm		
For models:	GN2100BT, GN2100TN, GN2100TNG, GN2200TN, GN3100BT, GN3100TN, GN3100TNG, GN4100BT, GN4100TN, GN4100TNG, GN4200TN, PA2100TN, PA3100TN, PZ2600TN, PZ2610TN, PZ3600TN, SNACK2100TN, SNACK3100TN, SNACK340, SNACK4100TN, SNACK638		



1

Part No.	750347	Ref. No.	S900.35
description	condenser W 220mm D 100mm H 230mm L 270mm		
For models:	PS200, PS900, S900, S901TOP, S902STD, SS45BT		



fastening material

screws

hexagonal screws



1

Part No.	696413	Ref. No.	GN650TN. 01 RC0316
description	screw thread M6 L 18mm		
For models:	GN1200BT, GN1200TN, GN1410BT, GN1410BTM, GN1410TN, GN1410TNG, GN1410TNM, GN600BT, GN600TN, GN650BT, GN650BTG, GN650BTM, GN650TN, GN650TNG, GN650TNM, GNB600BT, SNACK400SBT, SNACK400STN, SNACK400TN		

GASTROPARTS.COM

