



GASTROPARTS

Faema

- [EN]** Equipment
- [DE]** Geräte
- [ES]** Aparatos
- [FR]** Équipement
- [IT]** Attrezzature
- [PL]** Urządzenia
- [RU]** Оборудование

✉ gastroparts@gastroparts.com

☎ +48 56 657 00 66

📘 fb.com/gastroparts.global

GASTROPARTS.COM





heating elements

heating elements for coffee machine



1

Part No.	417113	Ref. No.	N/A
description	heating element 1000W 230V heating circuits 1 ø 57mm H 59mm W1 50mm H1 29mm H2 30mm mounting distance 44mm thread M12x1.25 stainless steel windings 3 tube ø 6.3mm immersion heater 2 hole fixing connection male faston 6.3mm		
accessories for	417113		
	Part No.	550681	Ref. No. —
	nut thread M12x1.25 H 5mm WS 17 brass Qty 1 pcs		



1

Part No.	417114	Ref. No.	N/A
description	heating element 1000W 230V heating circuits 1 ø 57mm H 60mm W1 38mm H1 29mm H2 31mm mounting distance 32mm thread 1/4" stainless steel windings 4 tube ø 6.3mm immersion heater 2 hole fixing		



1

Part No.	417014	Ref. No.	—
description	heating element 1300W 230V heating circuits 1 hole distance 59mm L 185mm W 40mm H 18mm hole ø 9mm tube ø 8.5mm connection male faston 6.3mm immersion heater 3 hole flange suitable for CIMBALI		
accessories for	417014		
	Part No.	529484	Ref. No. —
	flat gasket fibre ED ø 58mm ID ø 50mm thickness 2mm Qty 1 pcs		



1

Part No.	417083	Ref. No.	3541118963
description	heating element 1500W 220V heating circuits 1 mounting ø 42mm hole distance 61mm L 165mm W 25mm H 71mm hole ø 7mm tube ø 8mm connection M6 immersion heater 3 hole flange suitable for FAEMA		



1

Part No.	417002	Ref. No.	N/A
description	heating element 1500W 230V heating circuits 2 mounting ø 42mm hole distance 74mm L 140mm W 25mm H 58mm L1 16mm L2 54mm L3 70mm H1 26mm H2 32mm hole ø 11mm tube ø 8mm connection M6x1 immersion heater 2 hole flange suitable for FAEMA		
accessories for	417002		
	Part No.	528002	Ref. No. N/A
	flat gasket PTFE ED ø 57mm ID ø 42mm thickness 3mm Qty 1 pcs equiv. no. 12001/W10470 suitable for		
	Part No.	528488	Ref. No. —
	flat gasket fibre ED ø 57mm ID ø 42mm thickness 3mm Qty 1 pcs		



1

Part No.	417116	Ref. No.	N/A
description	heating element 1800W 230V heating circuits 2 mounting ø 42mm hole distance 74mm L 240mm W 36mm H 44mm L1 25mm L2 40mm L3 173mm H1 31mm H2 12mm hole ø 9mm tube ø 8.5mm thermostat sleeves ø 6mm length thermostat sleeves 205mm thermostat sleeve not clinging number of thermostat sleeves 1 connection M4 immersion heater 2 hole flange		



1

Part No.	417011	Ref. No.	421601010 421610000
description	heating element 1800W 230V heating circuits 3 hole distance 59mm L 170mm W 34mm H 35mm hole ø 9.7mm thermostat sleeves ø 7mm length thermostat sleeves 170mm number of thermostat sleeves 1 thermostat sleeve eccentric, non clinging tube ø 8.5mm connection male faston 6.3mm immersion heater 3 hole flange suitable for CIMBALI		
accessories for	417011		
	Part No.	528002	Ref. No. N/A
	flat gasket PTFE ED ø 57mm ID ø 42mm thickness 3mm Qty 1 pcs equiv. no. 12001/W10470 suitable for		
	Part No.	528488	Ref. No. —
	flat gasket fibre ED ø 57mm ID ø 42mm thickness 3mm Qty 1 pcs		





1

Part No.	417004	Ref. No.	3541116635
description	heating element 2400W 230V heating circuits 2 mounting ø 42mm hole distance 74mm L 175mm W 27mm H 58mm L1 30mm L2 55mm L3 90mm H1 28mm H2 30mm hole ø 9.5mm tube ø 8.5mm connection M6 immersion heater 2 hole flange suitable for FAEMA		
accessories for	417004		
	Part No.	525652	Ref. No. —
	grub screw thread M10 L 10mm brass DIN 914 intake hexagonal WS 5 Qty 1 pcs		



Table continues overleaf









accessories for 417004			
	Part No.	528002	Ref. No. N/A
	flat gasket PTFE ED ø 57mm ID ø 42mm thickness 3mm Qty 1 pcs equiv. no. 12001/W10470 suitable for		
	Part No.	528488	Ref. No. —
	flat gasket fibre ED ø 57mm ID ø 42mm thickness 3mm Qty 1 pcs		



			
Part No.	417581	Ref. No.	3541117863 3541134417
description	heating element 2440/2900W 220/240V heating circuits 2 mounting ø 42mm hole distance 74mm L 295mm W 28mm H 50mm L1 30mm L2 55mm L3 210mm H1 26mm H2 24mm hole ø 10mm tube ø 8.5mm thermostat sleeves ø 7mm length thermostat sleeves 208mm thermostat sleeve bottom/centre number of thermostat sleeves 1 connection M6 immersion heater 2 hole flange		

			
Part No.	417001	Ref. No.	3541133003
description	heating element 2600W 230V heating circuits 2 mounting ø 42mm hole distance 74mm L 330mm W 30mm H 60mm L1 23mm L2 65mm L3 202mm H1 30mm H2 30mm hole ø 12mm tube ø 8.5mm thermostat sleeves ø 7mm length thermostat sleeves 195mm thermostat sleeve eccentric, non clinging number of thermostat sleeves 1 connection M6 immersion heater 2 hole flange		

accessories for 417001			
	Part No.	528002	Ref. No. N/A
	flat gasket PTFE ED ø 57mm ID ø 42mm thickness 3mm Qty 1 pcs equiv. no. 12001/W10470 suitable for		
	Part No.	528488	Ref. No. —
	flat gasket fibre ED ø 57mm ID ø 42mm thickness 3mm Qty 1 pcs		

			
Part No.	417005	Ref. No.	N/A
description	heating element 2600W 230V immersion heater		
accessories for 417005			
	Part No.	528002	Ref. No. N/A
	flat gasket PTFE ED ø 57mm ID ø 42mm thickness 3mm Qty 1 pcs equiv. no. 12001/W10470 suitable for		
	Part No.	528488	Ref. No. —
	flat gasket fibre ED ø 57mm ID ø 42mm thickness 3mm Qty 1 pcs		

			
Part No.	417007	Ref. No.	N/A
description	heating element 2600W 230V immersion heater		
accessories for 417007			
	Part No.	528002	Ref. No. N/A
	flat gasket PTFE ED ø 57mm ID ø 42mm thickness 3mm Qty 1 pcs equiv. no. 12001/W10470 suitable for		
	Part No.	528488	Ref. No. —
	flat gasket fibre ED ø 57mm ID ø 42mm thickness 3mm Qty 1 pcs		

			
Part No.	417524	Ref. No.	903553010 903553016 903553020 903553030
description	heating element 3000/3570W 220-240V heating circuits 3 mounting ø 42mm hole distance 70mm L 210mm W 37mm H 69mm L1 25mm L2 60mm L3 125mm H1 33mm H2 36mm hole ø 10mm tube ø 8mm thermostat sleeves ø 6mm length thermostat sleeves 140mm thermostat sleeve centre not clinging number of thermostat sleeves 1 connection F6.3 immersion heater 2 hole flange suitable for FAEMA		
accessories for 417524			
	Part No.	529484	Ref. No. —
	flat gasket fibre ED ø 58mm ID ø 50mm thickness 2mm Qty 1 pcs		

			
Part No.	417582	Ref. No.	3541133004 3541-134418
description	heating element 3360/4000W 220/240V heating circuits 2 mounting ø 42mm hole distance 74mm L 415mm W 30mm H 46mm L1 45mm L2 45mm L3 325mm H1 22mm H2 24mm hole ø 10mm tube ø 8.5mm thermostat sleeves ø 7mm length thermostat sleeves 200mm thermostat sleeve bottom/centre number of thermostat sleeves 1 connection M6 immersion heater 2 hole fixing		

			
Part No.	417108	Ref. No.	N/A
description	heating element 3500W 230V heating circuits 2 mounting ø 42mm hole distance 74mm L 380mm W 30mm H 50mm L1 25mm L2 70mm L3 275mm H1 25mm H2 25mm hole ø 10mm tube ø 8.5mm thermostat sleeves ø 7mm length thermostat sleeves 190mm thermostat sleeve not clinging number of thermostat sleeves 1 connection M4 immersion heater 2 hole flange		

			
Part No.	417202	Ref. No.	2841135092 3541135077 911544000 911544010
description	heating element 4000W 230V heating circuits 3 mounting ø 42mm hole distance 74mm L 295mm W 34mm H 63mm L1 30mm L2 70mm L3 190mm H1 31mm H2 32mm hole ø 9mm tube ø 8.5mm thermostat sleeves ø 6.5mm length thermostat sleeves 199mm thermostat sleeve not clinging number of thermostat sleeves 1 connection male faston 6.3mm immersion heater 2 hole flange		
accessories for 417202			
	Part No.	528022	Ref. No. —
	flat gasket PTFE ED ø 52mm ID ø 41mm thickness 2mm size 1¼" Qty 1 pcs suitable for CARIMALI, FAEMA, MARZOCCO, PAVONI		
	Part No.	528488	Ref. No. —
	flat gasket fibre ED ø 57mm ID ø 42mm thickness 3mm Qty 1 pcs		





			
1			
Part No.	417583	Ref. No.	911545000 911545010 911545020
description	heating element 4500/5360W 220/240V heating circuits 3 mounting ø 42mm hole distance 74mm L 392mm W 32mm H 65mm L1 32mm L2 55mm L3 305mm H1 30mm H2 35mm hole ø 10mm tube ø 8.5mm thermostat sleeves ø 7mm length thermostat sleeves 150mm thermostat sleeve centre not clinging number of thermostat sleeves 1 connection male faston immersion heater 2 hole fixing		

			
1			
Part No.	417112	Ref. No.	3541-135 078
description	heating element 4500W 230V heating circuits 3 mounting ø 42mm hole distance 74mm L 390mm W 35mm H 70mm L1 30mm L2 50mm L3 300mm H1 33mm H2 37mm hole ø 9mm tube ø 8mm thermostat sleeves ø 6.5mm length thermostat sleeves 200mm thermostat sleeve not clinging number of thermostat sleeves 1 connection male faston 6.3mm immersion heater 2 hole flange		

			
1			
Part No.	417110	Ref. No.	3581130091
description	heating element 5000W 230V heating circuits 2 mounting ø 42mm hole distance 74mm L 525mm W 26mm H 45mm L1 25mm L2 80mm L3 420mm H1 30mm H2 15mm hole ø 10mm tube ø 8.5mm thermostat sleeves ø 7mm length thermostat sleeves 210mm thermostat sleeve eccentric, non clinging number of thermostat sleeves 1 connection M6 immersion heater 2 hole flange windings 2		

			
1			
Part No.	417584	Ref. No.	3541-134419
description	heating element 5040/6000W 220/240V heating circuits 2 mounting ø 42mm hole distance 74mm L 620mm W 25mm H 55mm L1 30mm L2 60mm L3 530mm H1 20mm H2 35mm hole ø 9mm tube ø 8.5mm thermostat sleeves ø 7mm length thermostat sleeves 210mm thermostat sleeve bottom/centre number of thermostat sleeves 1 connection M6 immersion heater 2 hole flange		

			
1			
Part No.	417585	Ref. No.	927597000 927597010 927597020
description	heating element 5400/6400W 220/240V heating circuits 3 mounting ø 42mm hole distance 74mm L 605mm W 34mm H 75mm L1 30mm L2 50mm L3 525mm H1 35mm H2 40mm hole ø 9mm tube ø 8.5mm thermostat sleeves ø 5.5mm length thermostat sleeves 150mm thermostat sleeve centre not clinging number of thermostat sleeves 1 connection male faston immersion heater 2 hole flange		

			
1			
Part No.	417099	Ref. No.	—
description	heating element 5790W 230V heating circuits 3 hole distance 59mm L 577mm W 35mm H 34mm hole ø 9.7mm thermostat sleeves ø 7mm length thermostat sleeves 170mm number of thermostat sleeves 1 thermostat sleeve not clinging tube ø 8mm connection male faston 6.3mm immersion heater 3 hole flange suitable for CIMBALI		

thermostats

control and safety thermostats

EGO

safety thermostats

55.32_ series

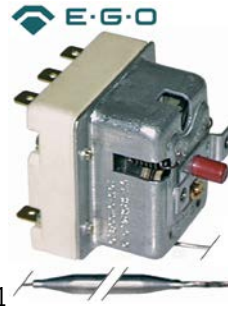

1			
Part No.	390166	Ref. No.	3231133006
description	safety thermostat switch-off temp. 150°C 3-pole 20A probe ø 6mm probe L 87mm capillary pipe 1490mm capillary pipe isolated 1250mm gland nut M9x1 probe SS		



1			
Part No.	390324	Ref. No.	3231-135 058 531-193 100
description	safety thermostat switch-off temp. 169°C 3-pole 3NC 20A probe ø 4mm probe L 128mm capillary pipe 890mm capillary pipe isolated 210/210mm gland nut probe SS		

switches and momentary switches

rocker/momentary rocker switches

19x13mm



1			
Part No.	301066	Ref. No.	3302136675 532-006 800
description	rocker switch mounting measurements 19x13mm black 2NO 250V 6A 0-I connection male faston 4.8mm ambient temperature max. 85°C protection IP40		
accessories for	301066		

1			
Part No.	301064	Ref. No.	—
description	protective cover for pressure switch external size 23,4x17,4mm internal size 19x13mm H 7.5mm clear mounting measurementsmm		



28x13.5mm



1

Part No.	347371	Ref. No.	3302-134 423 990-888 000
description	rocker switch mounting measurements 27.4x12.4mm black/green 2NO 250V 16A illuminated O connection male faston 6.3mm ambient temperature max. 85°C protection IP40		

push/momentary push switches

28.5x28.5mm



1

Part No.	345142	Ref. No.	3761130381
description	push switch mounting measurements 28.5x28.5mm red/green 2NO 250V 16A connection male faston 6.3mm ambient temperature max. 150°C protection IP40 with indicator		

accessories

push buttons



1

Part No.	400308	Ref. No.	4529-132 818 4531-133 348
description	push button black suitable for FAEMA series DUE S		
accessories for	400308		
	Part No.	Ref. No.	3341-132 683 532-021 708 800-132 683
	switch 2NO 250V 16A connection male faston 6.3mm		

protective covers



1

Part No.	347164	Ref. No.	802131619
description	protector H 6mm L 80mm W 26mm		

microswitches

universal



1

Part No.	345042	Ref. No.	3342-133 738 3761-119 075
description	microswitch with plunger 250V 16A 1CO connection male faston 6.3mm L 28mm ambient temperature max. 125°C mounting distance 22mm type EF83161.3 actuating force: 75g blue/black		
For models:	MC90		
accessories for	345042		
	Part No.	Ref. No.	—
	lever set 5-piece		

pin-plunger actuated



1

Part No.	347269	Ref. No.	3341-133 175 3341-135 175
description	microswitch 230V 16A 1NO connection male faston 6.3mm ambient temperature max. 85°C mounting distance 22mm with plunger red		



1

Part No.	305004	Ref. No.	3341-133 478
description	microswitch with plunger 250V 16A 1NO/1NC connection male faston 6.3mm ambient temperature max. 85°C mounting distance 22mm type XP2Z11 actuating force: 500g red stroke 8mm		





1

Part No.	347268	Ref. No.	3301-134 618 965-718 000
description	microswitch with plunger 400V 16A 2NO connection male faston 6.3mm ambient temperature max. 85°C mounting distance 22mm black stroke 15mm		
For models:	MC90		







			
1			
Part No.	347345	Ref. No.	3301-133 542
description	microswitch with plunger 400V 16A 2NO connection male faston 6.3mm ambient temperature max. 85°C mounting distance 22mm type XTD22P black stroke 15mm		

			
1			
Part No.	347271	Ref. No.	3301-133 541
description	microswitch 400V 3A 1CO connection male faston 2.8mm ambient temperature max. 85°C mounting distance 22mm green/grey stroke 2mm		
For models:	MC90		



			
1			
Part No.	345042	Ref. No.	3342-133 738 3761-119 075
description	microswitch with plunger 250V 16A 1CO connection male faston 6.3mm L 28mm ambient temperature max. 125°C mounting distance 22mm type EF83161.3 actuating force: 75g blue/black		
For models:	MC90		
accessories for	345042		
	Part No.	345043	Ref. No. —
	lever set 5-piece		



1			
Part No.	347452	Ref. No.	3341-134 617 965-719 000
description	safety switch 230V		
For models:	MC90		



miscellaneous			
			
1			
Part No.	347372	Ref. No.	532-015 900
description	momentary switch unit 250V 16A 1NO connection male faston 6.3mm ambient temperature max. 105°C		
accessories for	347372		
	Part No.	347362	Ref. No. 902-114 000
	push button grey suitable for FAEMA series E92 ELITE		

			
1			
Part No.	347373	Ref. No.	3761-132 128
description	switch 250V 16A 1NO connection male faston 6.3mm ambient temperature max. 105°C		
accessories for	347373		
	Part No.	347362	Ref. No. 902-114 000
	push button grey suitable for FAEMA series E92 ELITE		

system switches (ROLD)

			
1			
Part No.	347372	Ref. No.	532-015 900
description	momentary switch unit 250V 16A 1NO connection male faston 6.3mm ambient temperature max. 105°C		
accessories for	347372		
	Part No.	347362	Ref. No. 902-114 000
	push button grey suitable for FAEMA series E92 ELITE		

			
1			
Part No.	347373	Ref. No.	3761-132 128
description	switch 250V 16A 1NO connection male faston 6.3mm ambient temperature max. 105°C		
accessories for	347373		
	Part No.	347362	Ref. No. 902-114 000
	push button grey suitable for FAEMA series E92 ELITE		

			
1			
Part No.	345141	Ref. No.	3341-132 683 532-021 708 800-132 683
description	switch 2NO 250V 16A connection male faston 6.3mm		
accessories for	345141		
	Part No.	347362	Ref. No. 902-114 000
	push button grey suitable for FAEMA series E92 ELITE		
	Part No.	400308	Ref. No. 4529-132 818 4531-133 348
	push button black suitable for FAEMA series DUE S		



rotary switches

BREMAS

A1600 series



1

Part No.	345147	Ref. No.	2761130012
description	rotary switch 3 1-0-2 sets of contacts 6 type CS0169873 400V 16A shaft \varnothing 5x5mm shaft L 17mm shaft square connection screw		

miscellaneous



1

Part No.	347689	Ref. No.	3761119055
description	rotary switch sets of contacts 2 2 0-1 type CS20-00063 690V 25A shaft \varnothing 5x5mm shaft L 22mm shaft square connection male faston 6.3mm		

accessories

knobs



1

Part No.	111254	Ref. No.	3831-130 501
description	knob switch zero mark t.max. °C \varnothing 26mm shaft \varnothing 5x5mm shaft flat black H 20mm L 36mm		

lamps

indicator lights

indicator lamps for socket type SRZ / SDK / SDY / SFK



1

Part No.	359132	Ref. No.	902-524 000
description	indicator lamp green 250V connection male faston 6.3mm protection IP54 ambient temperature max. 85°C		

indicator lights (complete)

 \varnothing 10mm

with plug-in socket



1

Part No.	357014	Ref. No.	3541-116 308
description	indicator light \varnothing 10mm 250V red cable length 250mm socket push-in		

 \varnothing 12mm

with plug-in socket



1

Part No.	359041	Ref. No.	3541-133 504
description	indicator light \varnothing 12mm green 230V connection male faston 6.3mm temp.-resist. 120°C Qty 1 pcs		
For models:	MC90		



1

Part No.	359494	Ref. No.	3491-133 636 3591-133 546 535-573 008
description	indicator light \varnothing 12mm green 400V connection male faston 6.3mm temp.-resist. 120°C Qty 1 pcs		
For models:	MC90		



1

Part No.	347368	Ref. No.	3342-133 957 530-151 900
description	indicator light \varnothing 12mm 250V green		



1

Part No.	359493	Ref. No.	3402-133 614
description	indicator light \varnothing 12mm 250V green connection male faston 6.3mm temp.-resist. 120°C		



oven lamps

universal oven lamps

mounting diameter 47.8mm

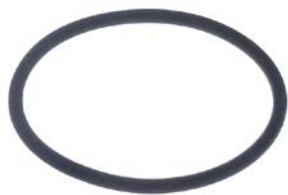

1

Part No.	525313	Ref. No.	4701-030 129 915-117 000
description	O-ring Viton ID ø 60.33mm thickness 3.53mm Qty 1 pcs		

contactors

ABB

power contactors



1

Part No.	380905	Ref. No.	2492-133 739 535-560 008
description	power contactor resistive load 25A 230/400VAC (AC3/400V) 9A/4kW main contacts 3NO auxiliary contacts 1NO connection screw connection type A9-30-10		
For models:	MC90		



1

Part No.	381017	Ref. No.	531506600 531-507 208 531507200
description	power contactor resistive load 30A 230VAC (AC3/400V) 17A/7.5kW main contacts 4NO auxiliary contacts connection screw connection type A16-40-00		

relays

time relays

time relays



1

Part No.	360468	Ref. No.	2341-117 504 531-202 308 531202208
description	time relay CDC TN 80 time range 3s-60min 24-230VAC/24-48VDC 6A 1CO 8-pole raster size 35x35mm		
accessories for	360468		
	Part No.	360230	Ref. No. —
	base		

probes

producer-specific probes

probes



1

Part No.	400082	Ref. No.	3761117825
description	temperature probe NTC 10kOhm cable probe -40 up to +110°C cable°C connection male faston 6.3mm thread probe ø10x30mm cable lengthm		

electronics

PCBs



1

Part No.	400580	Ref. No.	3301-091 861 3301-133 922
description	control PCB coffee machine		







1

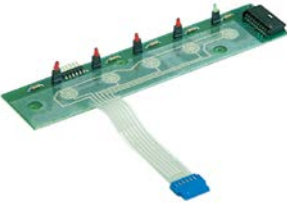

Part No.	402607	Ref. No.	537-036 700 537-036 708
description	display for coffee machine model E92 C		





1 			
Part No.	402829	Ref. No.	903-007 000 903-007 008
description	keypad PCB 2 groups L 469mm W 44mm suitable for FAEMA JUBILE buttons 11 for E61		

1 			
Part No.	400585	Ref. No.	3301135184
description	keypad PCB mounting pos. left		
accessories for	400585		
	Part No.	400304	Ref. No. 4831-132 302
buttons strip mounting pos. centre buttons 5 L 166mm W 22mm			

1 			
Part No.	400574	Ref. No.	3301-134 295 3301-134 925
description	keypad PCB suitable for FAEMA DIPLOMAT buttons 3 for E91 A		
accessories for	400574		
	Part No.	400307	Ref. No. 4533-133 828
push button dark grey suitable for FAEMA			
	Part No.	400575	Ref. No. 4831-134 292
buttons strip buttons 3 L 77mm W 59mm			

1 			
Part No.	400302	Ref. No.	3301-132 571 909954008
description	keypad PCB suitable for FAEMA DIPLOMAT mounting pos. right buttons 6 for E91		
accessories for	400302		
	Part No.	400305	Ref. No. 4831-132 303
buttons strip			

1 			
Part No.	402611	Ref. No.	902-768 008 902768000
description	keypad PCB suitable for FAEMA ELITE mounting pos. centre buttons 5 for E92 A		



1 			
Part No.	402614	Ref. No.	902-771 008 902771000
description	keypad PCB suitable for FAEMA ELITE mounting pos. centre buttons 5 for E92 S		

1 			
Part No.	402613	Ref. No.	902-769 008 902769000
description	keypad PCB suitable for FAEMA ELITE mounting pos. left buttons 6 for E92 S		

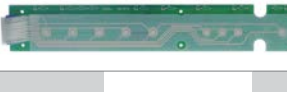
1 			
Part No.	402612	Ref. No.	902-767 008 902767000
description	keypad PCB suitable for FAEMA ELITE mounting pos. right buttons 9 for E92 A		

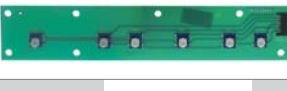
1 			
Part No.	402615	Ref. No.	902-770 008 902770000
description	keypad PCB suitable for FAEMA ELITE mounting pos. right buttons 9 for E92 S		

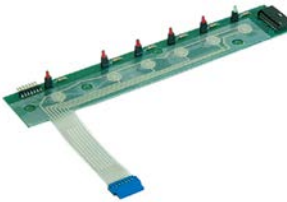
1 			
Part No.	402616	Ref. No.	903-510 018 903510010
description	keypad PCB suitable for FAEMA JUBILE 1 group buttons 6 for E61		

1 			
Part No.	400300	Ref. No.	3301-132 570
description	keypad PCB suitable for FAEMA mounting pos. left buttons 6 for E91		
accessories for	400300		
	Part No.	400303	Ref. No. 4831-132 300
buttons strip mounting pos. left buttons 6 L 190mm W 17mm			

1 			
Part No.	402610	Ref. No.	902-766 008 902766000
description	keypad PCB suitable for FAEMA mounting pos. left buttons 6 for E92 A		

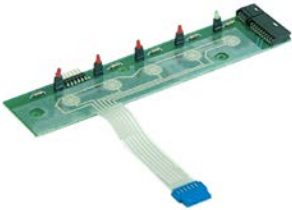
1

Part No.	400301	Ref. No.	3301-131 572 3301-132 572
description	keypad PCB suitable for FAEMA with LED mounting pos. centre buttons 5 for E91		
accessories for	400301		
	Part No.	400304	Ref. No. 4831-132 302
	buttons strip mounting pos. centre buttons 5 L 166mm W 22mm		



1

Part No.	400680	Ref. No.	3341132868 3341135683 537029600
description	PCB		

1

Part No.	400681	Ref. No.	3761130706
description	PCB		

1

Part No.	400682	Ref. No.	3761130707
description	PCB		



1

Part No.	400683	Ref. No.	3761130708
description	PCB		



1

Part No.	400684	Ref. No.	3761-119 516
description	PCB coffee machine		



1

Part No.	403440	Ref. No.	952846000 952846010
description	PCB coffee machine		



1

Part No.	400685	Ref. No.	3301-132 720 3301-132 721 3301134346 3341-134 037 3341-134 038 3341134039 3341134819 3341-135 069 3342133152 3342133153 3761-132 135 3761-132 142
description	PCB E91 FAEMA series DIPLOMAT		



1

Part No.	402621	Ref. No.	920-757 008 920-757 018 920-757 028
description	PCB E92 A / EMBLEMA RESTYLING FAEMA		



1

Part No.	402620	Ref. No.	537-029 500
description	PCB E92 A FAEMA series ELITE		



1

Part No.	402608	Ref. No.	902-038 000 902-038 008
description	PCB E92 A green LED triple		



1

Part No.	402609	Ref. No.	902-039 000 902-039 010 902-039 018
description	PCB E92 S cable length 110mm green LED triple		



1

Part No.	401299	Ref. No.	3341-134 100 5370-296 000 537-031 801 918-910 008
description	PCB FAEMA series E97, E98 NA32		



1

Part No.	402617	Ref. No.	535-517 008
description	PCB for sensor RESTYLING A series E92		



1

Part No.	402606	Ref. No.	3341-132 863 3341-135 935 535-514 008 903-011 000
description	PCB level regulator PRESIDENT S L 90mm W 70mm 230V		
For models:	PRESIDENT		

Triacs



1

Part No.	400032	Ref. No.	4761117735
description	Triac		

keypads

membrane keypad



1

Part No.	400437	Ref. No.	3301134529
description	membrane keypad		

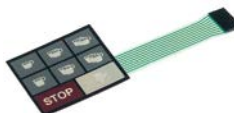

1

Part No.	400672	Ref. No.	3301132463 3529091848
description	membrane keypad		



1

Part No.	401407	Ref. No.	3301-134 930
description	membrane keypad		



1			
Part No.	400670	Ref. No.	442127000
description	membrane keypad 1 group suitable for FAEMA		

1			
Part No.	400675	Ref. No.	3301-134 530 3301-134 648
description	membrane keypad suitable for FAEMA L 68mm W 58mm		

control panel

2			
Part No.	400671	Ref. No.	495286000
description	membrane keypad 2 groups suitable for FAEMA		

1			
Part No.	531190	Ref. No.	4538134243
description	keypad housing L 240mm anthracite H 100mm for E91 A FAEMA		

1			
Part No.	400674	Ref. No.	3301-134 647
description	membrane keypad coffee machine buttons 6 L 58mm W 68mm		

accessories

1			
Part No.	400081	Ref. No.	3761131514
description	membrane keypad coffee machine COMPACT		

1			
Part No.	400305	Ref. No.	4831-132 303
description	buttons strip		

1			
Part No.	400309	Ref. No.	3301-132 827 3301-132 842
description	membrane keypad coffee machine DUE suitable for FAEMA old edition		

1			
Part No.	402599	Ref. No.	902-829 000
description	buttons strip buttons 1 L 30mm W 42mm gold		

1			
Part No.	401408	Ref. No.	3301-134 927
description	membrane keypad coffee machine parts buttons 6 suitable for FAEMA L 176mm W 49mm		

1			
Part No.	402600	Ref. No.	902-704 000
description	buttons strip buttons 1 L 30mm W 42mm silver		



1			
Part No.	400321	Ref. No.	902-037 010 902037000
description	membrane keypad L 149mm W 36mm		

1			
Part No.	402601	Ref. No.	902-703 000
description	buttons strip buttons 1 L 38mm W 42mm silver		





			
1			
Part No.	402595	Ref. No.	902-828 000
description	buttons strip buttons 1 L 42mm W 37mm gold suitable for FAEMA for E92 ELITE		

			
1			
Part No.	400581	Ref. No.	4831-134 255
description	buttons strip buttons 1 L 52mm W 22mm		

			
1			
Part No.	400575	Ref. No.	4831-134 292
description	buttons strip buttons 3 L 77mm W 59mm		
accessories for	400575		
	Part No.	400307	Ref. No. 4533-133 828
	push button dark grey suitable for FAEMA		
	Part No.	402604	Ref. No. 4538-133 828
	push button dark blue suitable for FAEMA		

			
1			
Part No.	402597	Ref. No.	902-827 000
description	buttons strip mounting pos. centre buttons 5 L 163mm W 42mm gold		

			
1			
Part No.	402655	Ref. No.	902-702 000
description	buttons strip mounting pos. centre buttons 5 L 163mm W 42mm silver suitable for FAEMA for E92 A		

			
1			
Part No.	400304	Ref. No.	4831-132 302
description	buttons strip mounting pos. centre buttons 5 L 166mm W 22mm		

			
1			
Part No.	400303	Ref. No.	4831-132 300
description	buttons strip mounting pos. left buttons 6 L 190mm W 17mm		

			
1			
Part No.	402596	Ref. No.	902-826 010
description	buttons strip mounting pos. left buttons 6 L 205mm W 42mm gold suitable for FAEMA for E92 ELITE		

			
1			
Part No.	402654	Ref. No.	902-701 010 902701000
description	buttons strip mounting pos. left buttons 6 L 205mm W 42mm silver suitable for FAEMA for E92 A		

			
1			
Part No.	402598	Ref. No.	902-825 000
description	buttons strip mounting pos. right buttons 9 L 305mm W 42mm gold		

			
1			
Part No.	402656	Ref. No.	902-700 000
description	buttons strip mounting pos. right buttons 9 L 305mm W 42mm silver suitable for FAEMA for E92 A		



			
1			
Part No.	402605	Ref. No.	903-003 007
description	push button chrome suitable for FAEMA for JUBILE E61		

			
1			
Part No.	402604	Ref. No.	4538-133 828
description	push button dark blue suitable for FAEMA		

			
1			
Part No.	402602	Ref. No.	3538-133 898
description	push button dark blue/chrome suitable for FAEMA		



			
1			
Part No.	400307	Ref. No.	4533-133 828
description	push button dark grey suitable for FAEMA		

			
1			
Part No.	347362	Ref. No.	902-114 000
description	push button grey suitable for FAEMA series E92 ELITE		
spare parts for	347362		
	Part No.	346104	Ref. No. —
	rotary switch 2 0-1 sets of contacts 3 type CA0170003 400V 20A shaft ø 5x5mm shaft L 21mm shaft square connection screw		

			
1			
Part No.	347370	Ref. No.	902-304 004
description	push button LUX gold suitable for FAEMA series E92 ELITE		

			
1			
Part No.	403053	Ref. No.	3531-134 911 990-728 000
description	push button ø 20mm H 21mm red/chrome		

			
1			
Part No.	347451	Ref. No.	902-458 000
description	push button suitable for FAEMA series E92 A ELITE		

solenoid valves

solenoid valves (water)

metal

LUCIFER

2-way

121F series



			
1			
Part No.	370592 ¹	Ref. No.	2441-134 294 533-898 300R
description	solenoid valve 2-ways 230VAC DN 1.5mm slide-on receptacle DIN -10 up to 140°C PARKER type series 121F coil type 483510S6 XS03XS6 F membranes ruby p max 20bar with flange plate flange 32x32mm nickel-plated brass inlet 6.1mm outlet 3.3mm		

¹nickel-plated

			
1			
Part No.	370626 ¹	Ref. No.	533-893 300 533-893 300R
description	solenoid valve 2-ways 24V DN 1.5mm slide-on receptacle DIN -10 up to 140°C PARKER type series 121F coil type 483510P0 XS03M F membranes ruby p max 20bar flange 32x32mm nickel-plated brass		



¹nickel-plated

7121ZBG series

			
1			
Part No.	370594 ¹	Ref. No.	2441135475 533-798 300 533-798 310 533-798 310R 533-895-200R
description	solenoid valve 2-ways 230VAC connection 1/8" L 30mm DN 2.5mm slide-on receptacle DIN -10 up to 140°C PARKER type series 7121ZBG coil type 483510S6 XS03XS6 F membranes FKM (water/steam) p max 10bar p min 0bar nickel-plated brass		
spare parts for	370594		
	Part No.	371031	Ref. No. —
	solenoid coil LUCIFER-PARKER 230VAC 9VA coil type DZ06S6 seat ø 15mm		
accessories for	370594		
	Part No.	371090	Ref. No. —
	power socket plug type DIN 43650A screw		





¹nickel-plated





3-way			
131F series			
			
1			
Part No.	370776	Ref. No.	533-894-600R
description	solenoid valve 2-ways 230VAC DN 1.5/2.5mm -10 up to 140°C PARKER type series 131F coil type DZ06S6 membranes ruby p max 10bar p min 0bar flange 32x32mm nickel-plated brass		
spare parts for	370776		
	Part No.	371031	Ref. No. —
	solenoid coil LUCIFER-PARKER 230VAC 9VA coil type DZ06S6 seat ø 15mm		
accessories for	370776		
	Part No.	371090	Ref. No. —
	power socket plug type DIN 43650A screw		

			
1			
Part No.	370593 ¹	Ref. No.	533795500 533795510 533795510R 533-894 500R
description	solenoid valve 3-ways 24VAC DN 1.5/2.5mm slide-on receptacle DIN -10 up to 140°C PARKER type series 131F coil type 483510P0 XS03M F membranes ruby p max 10bar p min 0bar flange 32x32mm nickel-plated brass		

¹nickel-plated

			
1			
Part No.	370054	Ref. No.	484074000
description	solenoid valve 3-ways 24VAC DN 2.5mm slide-on receptacle DIN -10 up to 140°C type series 131F coil type DZ06P0 membranes FKM (water/steam) p max 10bar flange 32x32mm		
spare parts for	370054		
	Part No.	370061	Ref. No. FA03
	solenoid valve body LUCIFER-PARKER 3-ways outer cone		
	Part No.	371032	Ref. No. —
	solenoid coil LUCIFER-PARKER 24VAC 9VA 50/60Hz coil type DZ06P0 seat ø 15mm		
accessories for	370054		
	Part No.	371090	Ref. No. —
	power socket plug type DIN 43650A screw		
	Part No.	371095	Ref. No. —
	O-ring Viton thickness 1.78mm ID ø 6.07mm Qty 1 pcs		

accessories for	370054		
	Part No.	371100	Ref. No. —
	O-ring silicone thickness 1.78mm ID ø 6.07mm Qty 1 pcs		

131K series			
			
1			
Part No.	370595	Ref. No.	533-895 800
description	solenoid valve 3-ways 230VAC connection 1/4" L 40mm DN 2.5mm slide-on receptacle DIN -10 up to 140°C PARKER type series 131K coil type 483510S6 F DZ06S6 membranes ruby p max 5bar brass DN 1 3mm DN 2 2.5mm		

spare parts and accessories

valve bodies

			
1			
Part No.	370061	Ref. No.	FA03
description	solenoid valve body LUCIFER-PARKER 3-ways outer cone		

PARKER

spare parts and accessories

valve bodies

			
1			
Part No.	370062	Ref. No.	FA02 FA03
description	solenoid valve body PARKER 3-ways outer cone		
accessories for	370062		
	Part No.	371029	Ref. No. —
	solenoid coil PARKER 230VAC 9VA coil type ZB09 seat ø 14mm H 33mm W 34mm D 43mm		
	Part No.	371030	Ref. No. —
	solenoid coil 24VDC 12VA coil type ZB12 seat ø 14mm		
	Part No.	371033	Ref. No. —
	solenoid coil PARKER 230VAC 9VA coil type YB09 with cable seat ø 14mm		
	Part No.	371036	Ref. No. —
	solenoid coil 24VAC 9VA coil type ZB09 seat ø 14mm		
	Part No.	371095	Ref. No. —
	O-ring Viton thickness 1.78mm ID ø 6.07mm Qty 1 pcs		

Table continues overleaf







accessories for	370062			
	Part No.	371100	Ref. No.	—
	O-ring silicone thickness 1.78mm ID ø 6.07mm Qty 1 pcs			

pressure switches

for coffee machines

miscellaneous

1 			
Part No.	541157	Ref. No.	468901022 537030700 F468901022
description	pressure control		

1 				
Part No.	541021	Ref. No.	2231116597	
description	pressure control pressure range adjustable 0.5-1.4bar connection 1/4" 30A 3-pole type P302 coffee machine parts SIRAI			
accessories for	541021			
	Part No.	550262	Ref. No.	—
	flat gasket copper ED ø 20mm ID ø 14mm thickness 2mm			
	Part No.	890100	Ref. No.	—
	PTFE tape reel L 12m W 12mm -200 up to +260°C approval DINDVGW, KTW temperature-resistant, elastic for fine thread thickness 0.1mm			

flow meters and flow sensors

flow meters

GICAR			
1 			
Part No.	403410	Ref. No.	534391800 534392300 534393100
description	flow controller thread 1/4" stainless steel coded approval NSF		

accessories			
1 			
Part No.	400258	Ref. No.	4701030130
description	O-ring for flow meter		

DIGMESA			
1 			
Part No.	400005	Ref. No.	2251131855
description	flow meter thread 1/4" brass with piggyback approval NSF reducer ø 1mm connection cable		

accessories			
1 			
Part No.	400259	Ref. No.	4831091782
description	impellor for DIGMESA		

pumps

booster pumps II





pump motors				
flange connection				
1 				
Part No.	500076	Ref. No.	2441116600	
description	pump motor AF type SEC10256/A 170W 230V 50/60Hz connection flange L 190mm W 100mm H 150mm capacitor 10µF			
accessories for	500076			
	Part No.	500314	Ref. No.	—
	coupling ø 40mm shaft diameter 10/11mm			

Table continues overleaf



accessories for	500076		
	Part No.	520158	Ref. No. —
	elastic coupling ø 40mm rubber		
	Part No.	525651	Ref. No. —
	coupling ø 40mm for shaft 3.5x7.5 for FAEMA		



1

Part No.	500077	Ref. No.	2441133416 530298400
description	pump motor AF type SEC10256/B 170W 230V 50/60Hz connection flange L 185mm W 110mm H 115mm capacitor 10µF		
accessories for	500077		
	Part No.	500066	Ref. No. —
	coupling set ø 40mm shaft intake ø 10/11mm		



1

Part No.	500062	Ref. No.	1000091851
description	pump motor RPM type 11039002 150W 230V 50Hz connection flange L 185mm W 155mm H 170mm capacitor 10µF		
accessories for	500062		
	Part No.	365015	Ref. No. 2341-119 567
	operating capacitor capacity 10µF 400V tolerance 5%Hz ambient temperature max. -25 to +85°C ø 35.5mm L 59mm M8 plastic connection male faston 6.3mm protection		

clip connection



1

Part No.	500442	Ref. No.	530-290-800
description	motor RPM type 11002708 165W 230V 50/60Hz connection clip capacitor 10µF shaft ø 13mm		

pump heads

FLUID-O-TECH



1

Part No.	500078	Ref. No.	N/A
description	pump head FA204 FLUID-O-TECH L 75mm 200l/h connection 3/8" GAS with bypass brass 2 hole flange for coffee machine shaft ø 11mm		





1

Part No.	501499	Ref. No.	2241130176 462707010 462713000 462714000 462991000 462991010 533180000 533180010 533197900 533408000 537048400 537048500
description	pump head FLUID-O-TECH 180l/h connection 3/8" GAS		



1

Part No.	500065	Ref. No.	N/A
description	pump head PA204F FLUID-O-TECH L 82mm 200l/h connection 3/8" NPT with bypass brass 3 hole flange for coffee machine shaft ø 11/10mm		
accessories for	500065		
	Part No.	500314	Ref. No. —
	coupling ø 40mm shaft diameter 10/11mm		
	Part No.	520158	Ref. No. —
	elastic coupling ø 40mm rubber		

miscellaneous



1

Part No.	499130	Ref. No.	N/A
description	pump head L 71mm 150/h connection 3/8" GAS shaft \varnothing 3.5x7.5mm		

accessories



1

Part No.	525210	Ref. No.	4821-135 956
description	coupling \varnothing 35mm H 11.5mm shaft diameter 3.5x7.5mm for FAEMA		



1

Part No.	525209	Ref. No.	4081-135 955
description	elastic coupling \varnothing 35mm H 5.5mm rubber		





1

Part No.	365015	Ref. No.	2341-119 567
description	operating capacitor capacity 10 μ F 400V tolerance 5%Hz ambient temperature max. -25 to +85°C \varnothing 35.5mm L 59mm M8 plastic connection male faston 6.3mm protection		

vibration pumps



1

Part No.	500123	Ref. No.	125219 533197400
description	vibration pump type 1106PAALM1N 230V 50Hz 70W inlet \varnothing 1/8" IT outlet \varnothing 1/8" IT outlet conical L 129mm FLUID-O-TECH		
accessories for	500123		
 Part No.	371090	Ref. No.	—
	power socket plug type DIN 43650A screw		
 Part No.	371120	Ref. No.	—
	diode type IN5408		
 Part No.	390698	Ref. No.	—
	thermal fuse switch-off temp. 110°C suitable for ULKA pump		





1

Part No.	500173	Ref. No.	N/A
description	vibration pump type EP 5 230V 48W 50Hz inlet \varnothing 6 outlet \varnothing 1/8" IT ULKA outlet flat plastic L 123mm		





1

Part No.	500124	Ref. No.	N/A
description	vibration pump type EX 5 230V 48W 50/60Hz inlet \varnothing 6 outlet \varnothing 1/8" IT flat seal ULKA brass L 123mm		
accessories for	500124		
 Part No.	520152	Ref. No.	—
	hose connector Santoprene grommet \varnothing 7mm grommet length 14mm		
 Part No.	520330	Ref. No.	—
	bracket rubber dimensions 69x44x4mm		



pumps for ice machines

			
1			
Part No.	500047	Ref. No.	889125070
description	pump REBO type MH30F1 30W 230V 50Hz outlet ø 12.7mm L 135mm rotation direction left		

			
1			
Part No.	365125	Ref. No.	2341-134 750 965473000
description	operating capacitor capacity 8µF 420/470V tolerance 5% ø 35mm L 58mm plastic-coated		

condensators & interference suppression filters

operating capacitors

plastic

			
1			
Part No.	365015	Ref. No.	2341-119 567
description	operating capacitor capacity 10µF 400V tolerance 5%Hz ambient temperature max. -25 to +85°C ø 35.5mm L 59mm M8 plastic connection male faston 6.3mm protection		

			
1			
Part No.	365124	Ref. No.	3341-134 535 965-506 000
description	operating capacitor capacity 8µF 420V tolerance 5% 50/60Hz ambient temperature max. -25 to +85°C ø 35mm L 60mm with discharge resistor M8 plastic connection male faston 6.3mm protection		

			
1			
Part No.	365123	Ref. No.	124744 3341-115 503
description	operating capacitor capacity 12.5µF 425V tolerance 5% 50/60Hz ambient temperature max. -25 to +85°C ø 36mm L 74mm plastic M8 plastic connection male faston 6.3mm 16.10.18SA protection		
For models:	MC90		

<p>metal</p> 			
1			
Part No.	365131	Ref. No.	531404100 531-492 800
description	capacitor capacity 5µF 450V tolerance 5% 50/60Hz ambient temperature max. -25 to +85°C ø 30mm L 60mm M8 aluminium connection male faston 6.3mm protection		

			
1			
Part No.	365021	Ref. No.	3341-131 517
description	operating capacitor capacity 16µF 425V tolerance 5% 50/60Hz ambient temperature max. -25 to +85°C ø 35mm L 73mm single M8 plastic connection male faston 6.3mm 416.10.99 protection		
For models:	MC90		

fuses

fine fuses

			
1			
Part No.	358661	Ref. No.	3501-117 399
description	fine fuse size ø5x20mm 0.1A fast-acting rated 250V Qty 10 pcs		

			
1			
Part No.	358677	Ref. No.	3501-117 396
description	fine fuse size ø5x20mm 4A fast-acting rated 250V Qty 10 pcs		



			
1			
Part No.	358533	Ref. No.	530-115 100
description	fine fuse size ø5x20mm 6.3A fast-acting rated 250V Qty 10 pcs		

			
1			
Part No.	358509	Ref. No.	3501-091 867
description	fine fuse size ø5x20mm 0.05A slow-acting rated 250V Qty 1 pcs		

			
1			
Part No.	358596	Ref. No.	3501-117 398
description	fine fuse size ø5x20mm 0.25A slow-acting rated 250V Qty 10 pcs		

electric accessories

cables

accessories

cable glands

cable glands

			
1			
Part No.	550310	Ref. No.	532123500
description	cable gland ID ø 5mm mounting ø 7mm ED ø 11mm Neoprene -30 up to +90°C Qty 10 pcs		

equipment-specific units

for espresso machines

filter holders

filter holders standard

filter holder without spout

			
1			
Part No.	525984	Ref. No.	N/A
description	filter holder suitable for AURORA/BRASILIA/FAEMA without outlet mounting ø 82.5mm outlet 3/8" ID ø 62mm wedge height 10.5mm wedge position horizontal number of wedges 2 lever straight		

filter holders short

			
1			
Part No.	529041	Ref. No.	N/A
description	filter holder mounting ø 82.5mm outlet 3/8" ID ø 62mm handle M12x1.75 wedge height 10.5mm wedge position horizontal number of wedges 2 lever straight chrome-plated brass		

			
1			
Part No.	525650	Ref. No.	N/A
description	filter holder mounting ø 83mm outlet M16x1 ID ø 62mm handle M10x1.5 wedge position horizontal number of wedges 2 lever straight chrome-plated brass		

handles

with bore

			
1			
Part No.	529046	Ref. No.	N/A
description	handle ø 31mm aperture 13x13mm L 90mm black		

			
1			
Part No.	529047	Ref. No.	N/A
description	handle ø 35mm aperture 13x13mm L 95mm black		

spouts

accessories

			
1			
Part No.	527633	Ref. No.	4162-015 073
description	cover L 54mm W 13mm H 23mm stainless steel		



filters

for 1 cup



1

Part No.	531277	Ref. No.	457232000
description	coffee filter ø 69mm mounting ø 60mm H 18mm cups 1 amount of coffee 6g stainless steel		



1

Part No.	529075	Ref. No.	N/A
description	coffee filter ø 70mm mounting ø 60.5mm H 24.5mm cups 1 amount of coffee 7g ECONOMY		



1

Part No.	527631	Ref. No.	N/A
description	coffee filter ø 70mm mounting ø 60.7mm H 17mm cups 1 amount of coffee 8g		



1

Part No.	529012	Ref. No.	N/A
description	coffee filter ø 70mm mounting ø 60.8mm H 19.5mm cups 1 amount of coffee 6g		



1

Part No.	529011	Ref. No.	N/A
description	coffee filter ø 70mm mounting ø 60mm H 24.5mm cups 1 amount of coffee 7g perforation ø 0.4mm		

for 2 cups



1

Part No.	531278	Ref. No.	458171000
description	coffee filter ø 68mm mounting ø 60mm H 25.5mm cups 2 amount of coffee 14g		



1

Part No.	531279	Ref. No.	457233000
description	coffee filter ø 69mm mounting ø 60mm H 22mm cups 2 amount of coffee 12g		



1

Part No.	529076	Ref. No.	N/A
description	coffee filter ø 70mm mounting ø 60.8mm H 24.5mm cups 2 amount of coffee 14g ECONOMY		

brewing units

shower screens

with upstand



1

Part No.	529083	Ref. No.	N/A
description	shower screen ø 58mm H 19mm		



1

Part No.	531275	Ref. No.	457560000
description	shower screen ø 58mm H 19mm		





			
1			
Part No.	529080	Ref. No.	4771026100
description	shower screen ø 58mm H 20mm		

filter holder gaskets			
flat			
with internal notch			
			
1			
Part No.	528070	Ref. No.	N/A
description	filter holder gasket D1 ø 74mm D2 ø 57.5mm H 8mm with inside notch Qty 1 pcs		

standard			
			
1			
Part No.	528032	Ref. No.	N/A
description	filter holder gasket D1 ø 73mm D2 ø 57mm H 9mm Qty 1 pcs		

shim gaskets			
			
1			
Part No.	528033	Ref. No.	N/A
description	shim gasket D1 ø 71mm D2 ø 58mm thickness 0.8mm paper Qty 1 pcs		

brewing units with solenoid valve			
gaskets			
			
1			
Part No.	528350	Ref. No.	4701-116 687
description	O-ring Viton thickness 2.62mm ID ø 9.13mm Qty 1 pcs		

brewing units manual			
components			
drain units			
drain pipes			
			
1			
Part No.	525330	Ref. No.	4822-135 919 903-164 000
description	drain pipe thread M30x1.5 T1: 1/2" int. ø 1 28mm int. ø 2 19mm L 72mm WS 36 L1 36mm L2 23mm suitable for FAEMA for E61		

			
1			
Part No.	528538	Ref. No.	4152-135 921
description	end piece thread 1/2" int. ø 1 12mm int. ø 2 15mm L 36mm chrome-plated brass WS 26		

gaskets			
			
1			
Part No.	525309	Ref. No.	402-205 000 4701-019 545
description	gasket ED ø 13mm ID ø 4mm H 4mm Qty 1 pcs Viton		

tap aerators			
			
1			
Part No.	527872	Ref. No.	4151-135 920
description	tap aerator ID ø 6mm brass ED ø 15mm L 14mm		

bushes			
			
1			
Part No.	528541	Ref. No.	4151-135 904
description	bush D1 ø 15mm D2 ø 10.8mm ID ø 8mm H 30mm brass		



gaskets



1

Part No.	525309	Ref. No.	402-205 000 4701-019 545
-----------------	--------	-----------------	-----------------------------

description gasket ED ø 13mm ID ø 4mm H 4mm Qty 1 pcs Viton



1

Part No.	525311	Ref. No.	4701-135 888
-----------------	--------	-----------------	--------------

description group gasket L 77mm W 72mm thickness 2mm aperture 9mm hole distance 56mm suitable for FAEMA PTFE

miscellaneous



1

Part No.	528546	Ref. No.	N/A
-----------------	--------	-----------------	-----

description adjusting ring for brewing unit suitable for FAEMA series E64, E66, P4, P6



1

Part No.	525341	Ref. No.	4021-135 902
-----------------	--------	-----------------	--------------

description locking screw for cam shaft suitable for FAEMA E61 series LEGEND



1

Part No.	525318	Ref. No.	4831-135 865
-----------------	--------	-----------------	--------------

description shaft bearing suitable for FAEMA E61

levers

levers



1

Part No.	525302	Ref. No.	4831-135 866
-----------------	--------	-----------------	--------------

description actuator L 56mm for FAEMA model E61 LEGEND

accessories for 525302



Part No.	560370	Ref. No.	503-605 160
-----------------	--------	-----------------	-------------

countersunk screw thread M5 L 16mm stainless steel DIN 965/ISO 7046 Qty 1 pcs intake Phillips head ø 9mm



1

Part No.	531057	Ref. No.	2819-136 651
-----------------	--------	-----------------	--------------

description lever for FAEMA chrome-plated brass

valves



1

Part No.	525351	Ref. No.	2161-136 649
-----------------	--------	-----------------	--------------

description valve group outflow L 61.6mm ED ø 15.5mm shaft ø 4mm



1

Part No.	525352	Ref. No.	2161-136 656 903-835 000
-----------------	--------	-----------------	-----------------------------

description valve group supply L 58.6mm ED ø 15.5mm

components

nozzles

bushes



1

Part No.	528321	Ref. No.	4151-135 895
-----------------	--------	-----------------	--------------

description filter support D1 ø 13mm ID ø 5mm int. ø 1 11mm H 9mm brass

nozzle holders



1

Part No.	525346	Ref. No.	2211-116 078 922785000
-----------------	--------	-----------------	---------------------------

description nozzle holder with nozzle

spare parts for 525346

Part No.	528582	Ref. No.	—
-----------------	--------	-----------------	---

nozzle

Part No.	528584	Ref. No.	—
-----------------	--------	-----------------	---

nozzle holder

accessories for 525346

Part No.	528350	Ref. No.	4701-116 687
-----------------	--------	-----------------	--------------

O-ring Viton thickness 2.62mm ID ø 9.13mm Qty 1 pcs



with thread

 <p>1</p>			
Part No.	528486	Ref. No.	4151-135 890
description	nozzle bore ø 0.7mm thread M6x0.75 L 9mm WS 7		

 <p>1</p>			
Part No.	525343	Ref. No.	903-057 000
description	nozzle bore ø 1mm thread M6 L 9mm		

springs

 <p>1</p>			
Part No.	525321	Ref. No.	4731-135 896
description	compression spring ø 13mm L 37.5mm wire gauge ø 1.1mm windings 7 E61 series LEGEND		

washers

 <p>1</p>			
Part No.	525308	Ref. No.	4051-136 004
description	plain washer ID ø 6.4mm ED ø 11mm thickness 1.5mm SS Qty 1 pcs		

screw connections

 <p>1</p>			
Part No.	527270	Ref. No.	4142-135 892
description	end cap thread M16x1.5 ID ø 8.9mm L 21mm chrome-plated WS 22		

gaskets

 <p>1</p>			
Part No.	525311	Ref. No.	4701-135 888
description	group gasket L 77mm W 72mm thickness 2mm aperture 9mm hole distance 56mm suitable for FAEMA PTFE		

water dispersions

water dispersions			
water dispersions			
group 2			
 <p>1</p>			
Part No.	531081	Ref. No.	4161-133 848 457-342 000 902-405 006
description	water distributor brass		

expansion valves

 <p>1</p>			
Part No.	529300	Ref. No.	N/A
description	expansion valve T1: 3/8" ET T2: 3/8" ET L 46mm		

with hose connection

 <p>1</p>			
Part No.	525327	Ref. No.	2211-134 651
description	expansion valve T1: 1/4" ET hose ø 10mm total length 72mm		

brass 3-way

 <p>1</p>			
Part No.	525356	Ref. No.	415-928 000 415-929 010 415-929 020 415-932 000 415-932 010 427-954 000 537-027 900
description	expansion valve T1: 1/8" connection 7		



drain valves

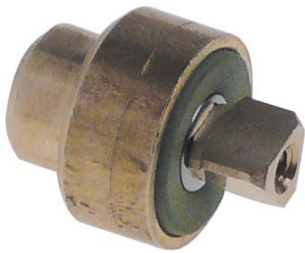

1

Part No.	531078	Ref. No.	2161-136 648 903-828 000
description	drain fitting		

drain pans

covers



1

Part No.	525345	Ref. No.	4831-134 635 484353000
description	lid for drain pan hole \varnothing 15mm suitable for FAEMA		

drain units



1

Part No.	698910	Ref. No.	990073000
description	drain connection connections 3/4" for espresso machine ED \varnothing 58mm ID \varnothing 52mm		

drain pans



1

Part No.	525344	Ref. No.	4831-132 932 484352000
description	drain pan suitable for FAEMA		

aerators and air bleeders



1

Part No.	525329	Ref. No.	3161-134 654 418911002 418911010 418932000 418941000 418941010 537-040 300
description	aerator and air bleeder connection 1/4" for boiler suitable for CIBBALI, FAEMA		

boilers

gaskets

unperforated



1

Part No.	528100	Ref. No.	N/A
description	boiler gasket D1 \varnothing 149mm D2 \varnothing 138mm thickness 3mm PTFE suitable for FAEMA		

miscellaneous



1

Part No.	528109	Ref. No.	N/A
description	lid for boiler 12 holes E61		





1

Part No.	528106	Ref. No.	N/A
description	ring for boiler 16 holes		

steam/water taps

steam/water taps

steam/water taps



1

Part No.	529500	Ref. No.	2221-091 783
description	steam tap		
accessories for	529500		
	Part No.	525340	Ref. No. 3121-134 865
	joint for steam pipe		



1

Part No.	529503	Ref. No.	485-923 012 485-923 022
description	steam tap suitable for FAEMA series E98		
spare parts for	529503		
	Part No.	528517	Ref. No. —
	plain washer ID ø 16.2mm ED ø 21.8mm thickness 1mm Qty 1 pcs		
	Part No.	528518	Ref. No. 568-101 000
	retaining ring bore ø 22mm thickness 1.2mm steel DIN 472		
	Part No.	529412	Ref. No. 400-279 000
	O-ring EPDM thickness 2.62mm ID ø 10.78mm Qty 1 pcs		
	Part No.	529546	Ref. No. 400-274 010 400-274 020
	gasket D1 ø 12mm D2 ø 4mm thickness 4mm Viton Qty 1 pcs		



1

Part No.	525326	Ref. No.	2221-134 646
description	steam/water tap inlet 1/4" outlet M20x1.5 suitable for FAEMA series DUE		



1

Part No.	525328	Ref. No.	485-923 022 485-923 030
description	steam/water tap suitable for FAEMA series E98		
spare parts for	525328		
	Part No.	528517	Ref. No. —
	plain washer ID ø 16.2mm ED ø 21.8mm thickness 1mm Qty 1 pcs		
	Part No.	528518	Ref. No. 568-101 000
	retaining ring bore ø 22mm thickness 1.2mm steel DIN 472		
	Part No.	529412	Ref. No. 400-279 000
	O-ring EPDM thickness 2.62mm ID ø 10.78mm Qty 1 pcs		
	Part No.	529546	Ref. No. 400-274 010 400-274 020
	gasket D1 ø 12mm D2 ø 4mm thickness 4mm Viton Qty 1 pcs		

components

bushes



1

Part No.	525355	Ref. No.	4151-030 015
description	bush for steam-/water-tap D1 ø 10.5mm D2 ø 9mm ID ø 6.3mm H 4mm brass		

gaskets





1

Part No.	528496	Ref. No.	N/A
description	gasket		





			
1			
Part No.	529546	Ref. No.	400-274 010 400-274 020
description	gasket D1 ø 12mm D2 ø 4mm thickness 4mm Viton Qty 1 pcs		

gasket supports			
			
1			
Part No.	525175	Ref. No.	2151136654
description	valve ø hexagon 16mm L 14mm brass		

springs			
			
1			
Part No.	528509	Ref. No.	4731-030 495
description	compression spring ø 11mm L 31mm wire gauge ø 1.2mm windings 9		

			
1			
Part No.	525323	Ref. No.	4731-135 884
description	compression spring ø 11mm L 32mm wire gauge ø 1.7mm windings 7 E61		

			
1			
Part No.	525319	Ref. No.	4731-135 883
description	compression spring ø 15mm L 17mm wire gauge ø 1.8mm windings 5 E61		

			
1			
Part No.	531262	Ref. No.	4731133611
description	spring L 35mm wire gauge ø 0.85mm for steam valve E92 Elite		

tap bodies			
			
1			
Part No.	530547	Ref. No.	958572010
description	tap body T1: 1/4" T2: 3/8" L 99mm		

screws			
			
1			
Part No.	525350	Ref. No.	590-791 010
description	screw for water tap thread M4		

valve bodies			
			
1			
Part No.	525363	Ref. No.	485751000 485751010 485-910 002 485-910 010 985710000 985710010
description	valve body for steam-/water-tap		

steam/water pipes			
			
1			
Part No.	531079	Ref. No.	3951-136 653
description	pipe steam/water E61 edition old edition suitable for FAEMA		

steam pipes			
			
1			
Part No.	525336	Ref. No.	903-505 000
description	pipe thread 1 L 245mm ø 14.1mm for steam/water pipes tube ø 10mm E61		

			
1			
Part No.	525334	Ref. No.	2221-133 709 3952-133 708
description	steam pipe thread M20x1.5 H 130mm L 180mm ø 16mm tube ø 10mm SS E91 / DUE		



			
1			
Part No.	525335	Ref. No.	2221-133 434 3951-133 428
description	steam pipe thread M20x1.5 H 145mm L 180mm ø 14.1mm tube ø 10mm SS E91 / DUE		

			
1			
Part No.	525338	Ref. No.	537-033 010 537033000
description	steam pipe with adapter thread M20x1.5 H 140mm L 205mm ø 14.1mm tube ø 10mm SS suitable for FAEMA		

nozzles for steam pipes			
			
1			
Part No.	529585	Ref. No.	4158-135 926
description	steam nozzle thread M10x1 ø 14mm L 16mm 4 holes bore ø 2mm chrome-plated brass		

nozzles for water pipes			
tap aerators			
			
1			
Part No.	525331	Ref. No.	4151-135 927
description	tap aerator D1 ø 22mm H 45mm thread M10 suitable for FAEMA series E61		

water pipes			
			
1			
Part No.	525336	Ref. No.	903-505 000
description	pipe thread 1 L 245mm ø 14.1mm for steam/water pipes tube ø 10mm E61		

			
1			
Part No.	525333	Ref. No.	2221-134 421
description	water pipe ø 23.5mm L 80mm tube ø 10mm E97		

			
1			
Part No.	525362	Ref. No.	2221-135 266 485149000 922-792 000 922-792 010 936-960 010 936960000
description	water pipe thread 3/8" ø 17mm L 65mm		

			
1			
Part No.	525337	Ref. No.	903-740 000 903-740 010 903-950 000
description	water pipe thread M16x1 ø 14.1mm L 280mm suitable for FAEMA E61		

			
1			
Part No.	525332	Ref. No.	2221-134 620 985-718 000
description	water pipe thread M20x1.5 ø 23.5mm L 64mm suitable for FAEMA		

accessories			
bushes			
			
1			
Part No.	525324	Ref. No.	485-078 000 485-078 010
description	bush D1 ø 14.3mm D2 ø 11.4mm H 6mm PTFE ID ø 7.1mm		

			
1			
Part No.	525357	Ref. No.	4161-132 346
description	bush D1 ø 15mm D2 ø 10.4mm H 10.3mm PTFE ID ø 7.6mm		

gaskets			
			
1			
Part No.	528402	Ref. No.	402-206 000 4701-114 266
description	O-ring Viton thickness 2.62mm ID ø 10.78mm Qty 1 pcs		



springs



Part No.	525317	Ref. No.	485-061 010 F485-061 010
description	compression spring \varnothing 11mm L 23.5mm wire gauge \varnothing 1.9mm		

tube handles



Part No.	525301	Ref. No.	430-119 000 430-119 010 4701-134 278
description	tube handle for pipe \varnothing 10mm \varnothing 16mm L 35mm rubber		

washers



Part No.	525314	Ref. No.	4051-047 130
description	plain washer ID \varnothing 7.5mm ED \varnothing 15mm thickness 1mm brass Qty 1 pcs		

fuse terminal blocks



Part No.	525315	Ref. No.	4731-134 862 485-147 000
description	retainer clip wire gauge \varnothing 1.5mm for steam pipe coffee machine		

miscellaneous



Part No.	525340	Ref. No.	3121-134 865
description	joint for steam pipe		

gaskets

piston seals



Part No.	530427	Ref. No.	402199010
description	piston gasket D1 \varnothing 74mm D2 \varnothing 58mm		

fine filters

holders



Part No.	528321	Ref. No.	4151-135 895
description	filter support D1 \varnothing 13mm ID \varnothing 5mm int. \varnothing 1 11mm H 9mm brass		

fine filters



Part No.	528326	Ref. No.	4771-135 894
description	fine filter flat \varnothing 11.2mm		



Part No.	528562	Ref. No.	4771-116 081
description	fine filter flat \varnothing 9mm		

intake valves

accessories

nozzles



Part No.	525348	Ref. No.	902-808 000
description	nozzle for filling valve bore \varnothing 0.8mm thread M3 L 6.3mm		

spare parts for 525348



Part No.	526824	Ref. No.	4701-117 916
description	O-ring EPDM thickness 1.9mm ID \varnothing 5.7mm Qty 1 pcs		



Part No.	525349	Ref. No.	2151-133 912
description	nozzle for filling valve bore \varnothing 1.2mm thread M3 L 6.3mm		

springs



Part No.	525320	Ref. No.	4731-027 556
description	compression spring \varnothing 6.6mm L 20.5mm wire gauge \varnothing 0.5mm windings 11		

levers



Part No.	525339	Ref. No.	4831-117 704
description	lever for filling valve plastic suitable for FAEMA series E91		





miscellaneous

1 			
Part No.	525237	Ref. No.	4831-117 838
description	spring guide for filling valve D1 ø 15mm D2 ø 5mm H 7mm		

1 			
Part No.	525353	Ref. No.	4831-029 417
description	spring guide for filling valve D1 ø 21.2mm D2 ø 17mm int. ø 1 7mm H 11.5mm		

valves

1 			
Part No.	525366	Ref. No.	2211-130 305 419-505 000 922787000
description	inlet tap for filling valve L 42.5mm suitable for FAEMA E97		

1 			
Part No.	525365	Ref. No.	3211-029 421 419-506 000 922788000
description	valve for filling valve L 16mm suitable for FAEMA		

1 			
Part No.	525364	Ref. No.	2211-117 836 419-504 000 922789000
description	valve for filling valve L 25mm suitable for FAEMA		

1 			
Part No.	525347	Ref. No.	2211-132 290
description	valve for filling valve suitable for FAEMA E91 / DUE		

level glasses

level glasses

gaskets

1 			
Part No.	529363	Ref. No.	4701-116 573
description	gasket L 90.5mm W 29.5mm thickness 1.5mm fibre water level glass suitable for FAEMA		

housings

1 			
Part No.	525779	Ref. No.	4831-132 157
description	tray for water level tube plastic suitable for FAEMA		

level glasses

1 			
Part No.	529365	Ref. No.	4831-130 683
description	level glass L 89mm W 30mm thickness 3.5mm for water level tube polycarbonate		

level glasses (complete)

1 			
Part No.	525325	Ref. No.	990-716 010 990716000
description	level glass thread 3/8" suitable for FAEMA		

miscellaneous

1 			
Part No.	531276	Ref. No.	911025000 927237000
description	guide for grate thread M10x1.5 ø 12.5mm L 42mm PTFE		

1 			
Part No.	530548	Ref. No.	533001200
description	level electrode ø 2.5mm L 154mm		



for coffee grinders

grinding burrs

grinding burrs straight

standard



1

Part No.	527224	Ref. No.	N/A
description	grinding burrs pair turn direction left D1 ø 54mm ID ø 31mm H 8mm tooth spacing 3.5mm hole ø 4.5mm bore ø 6.5mm mounting ø 45 straight suitable for FAEMA (FP)		



1

Part No.	527223	Ref. No.	4801-116 730
description	grinding burrs pair turn direction right D1 ø 54mm ID ø 31mm H 8mm tooth spacing 3.5mm hole ø 4.5mm bore ø 6.5mm mounting ø 45 straight suitable for FAEMA (MP, MPN)		



1

Part No.	527225	Ref. No.	N/A
description	grinding burrs pair turn direction right D1 ø 64mm ID ø 38mm H 9mm tooth spacing 2.5mm hole ø 5mm bore ø 8mm mounting ø 50 straight suitable for FAEMA (Silver)		



1

Part No.	525647	Ref. No.	4801-133 539
description	grinding burrs pair turn direction right D1 ø 75mm ID ø 43.7mm H 9.3mm tooth spacing 3.5mm hole ø 5.5mm bore ø 9mm mounting ø 57		

TITAN



1

Part No.	526274	Ref. No.	990-709 000
description	grinding burrs pair turn direction right D1 ø 75mm ID ø 43.7mm H 9.3mm tooth spacing 3.5mm hole ø 5.5mm bore ø 9mm mounting ø 57 titanium		

grinding burrs conical



1

Part No.	527226	Ref. No.	N/A
description	grinding burrs pair turn direction right D1 ø 68mm D2 ø 49mm H 25mm shaft ø 11mm suitable for FAEMA		



1

Part No.	527431	Ref. No.	2801-131 470
description	grinding burrs pair turn direction right D1 ø 68mm D2 ø 49mm H 25mm shaft ø 11mm suitable for FAEMA		
For models:	MC90		

dosing containers

dosing container lids



1

Part No.	526285	Ref. No.	4529-133 527 990-710 000
description	lid for dosing container ø 121mm 2-piece		



1

Part No.	526284	Ref. No.	4831-130 210 4831-132 155
description	lid for dosing container ø 58mm H 12mm		



glass cylinders



1

Part No.	526278	Ref. No.	4504-133 562 965465000
description	cylinder for dosing container ø 129mm H 121mm		

levers

levers



1

Part No.	526277	Ref. No.	2811-136 553 3529-135 703 4529-133 512 4529-133 513
description	lever right dosing pump hole ø 18mm L 108mm		



1

Part No.	526276	Ref. No.	4816-132 160
description	lever right dosing pump hole ø 20mm L 120mm brass		
For models:	MC90		



1

Part No.	526333	Ref. No.	4812-117 455
description	lever right dosing pump hole ø 20mm L 120mm chrome-plated		
For models:	MC90		

coffee presses

components

pressers



1

Part No.	526287	Ref. No.	465-875 000 4811-133 592 4815-133 591
description	coffee press ø 57mm L 100mm H 11mm thread M10x1.5 plastic		



1

Part No.	526288	Ref. No.	3831-134 913
description	coffee press with bolt ø 57mm L 129mm H 25mm thread M6x1 plastic		

coffee presses



1

Part No.	526286	Ref. No.	1000-091 907 3529-134 432 965-081 000
description	coffee press complete ø 57mm L 70mm H 94mm		
For models:	MC90		

automatic grinding

automatic grinding



1

Part No.	698757	Ref. No.	4529133522	
description	housing for microswitch H 26mm L 102mm			
accessories for	698757			
	Part No.	698756	Ref. No.	4529133521
				lid for microswitch H 20mm



1

Part No.	698756	Ref. No.	4529133521
description	lid for microswitch H 20mm		

nuts



1

Part No.	560502	Ref. No.	4034008834
description	hexagonal nut thread M12x1.5 H 6mm WS 19 SS Qty 1 pcs zinc-plated		
For models:	MC90		



miscellaneous



Part No.	531199	Ref. No.	4081025146
description	clamping ring for dosing container \varnothing 26mm internal size 23mm thickness 1.5mm suitable for FAEMA		

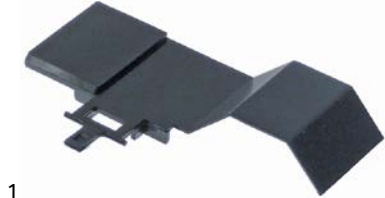

Part No.	531200	Ref. No.	4831119081
description	lever for microswitch L 110mm W 36mm thickness 1mm plastic suitable for FAEMA		



Part No.	560501	Ref. No.	4054043141
description	plain washer ID \varnothing 12.4mm ED \varnothing 25mm thickness 1.5mm SS Qty 1 pcs		
For models:	MC90		



Part No.	531201	Ref. No.	4831119077
description	plate for lid L 25mm W 17mm thickness 3mm plastic suitable for FAEMA		
For models:	MC90		

ratches

pins



Part No.	526299	Ref. No.	4061-119 924
description	pin for ratchet \varnothing 5mm D2 \varnothing 4mm L 18mm		
For models:	MC90		



Part No.	526298	Ref. No.	4061-133 599
description	pin for ratchet \varnothing 5mm L 16mm		

accessories



Part No.	531202	Ref. No.	4831117454
description	bush for pin \varnothing 9mm int. \varnothing 1 5mm plastic		
For models:	MC90		

adjustment mechanism

lockable adjustment



Part No.	526289	Ref. No.	3811-133 571
description	pressure pin for setting ring L 30mm W 25mm shaft \varnothing 6mm shaft length 25mm		



Part No.	526290	Ref. No.	3831-117 444
description	pressure pin for setting ring L 49mm W 17mm shaft \varnothing 8mm shaft length 23mm		

setting rings



Part No.	531189	Ref. No.	3851117441
description	setting ring for coffee grinder \varnothing 104mm ID \varnothing 51mm H 35mm suitable for FAEMA plastic		

coffee beans containers

container lids



Part No.	526281	Ref. No.	4529-134 582 4831-130 111 965422000
description	container lid for coffee beans container \varnothing 266mm W 50mm		
For models:	MC90		



1

Part No.	526283	Ref. No.	4831-130 222 4831-132 087
description	lid coffee beans container L 154mm W 154mm		



1

Part No.	526282	Ref. No.	4529-133 528
description	lid coffee beans container ø 189mm		



1

Part No.	527327	Ref. No.	N/A
description	lid for coffee beans container ø 210mm		

coffee beans containers



1

Part No.	526963	Ref. No.	4504-133 563 4504135040 465-818 000
description	coffee beans container brown ø 193mm H 245mm seat ø 67mm		



1

Part No.	526279	Ref. No.	3504-133 560
description	coffee beans container brown ø 260mm H 222mm seat ø 55mm		
For models:	MC90		



1

Part No.	526280	Ref. No.	3527-133 557 3529-133 557
description	coffee beans container L 160mm W 160mm H 240mm seat ø 51mm		



knobs

producer-specific knobs

FAEMA



1

Part No.	111365	Ref. No.	3533-133 899 3538-133 899
description	knob switch zero mark ø 40mm shaft ø 5x5mm shaft flat horizontal dark blue		



1

Part No.	111254	Ref. No.	3831-130 501
description	knob switch zero mark t.max.°C ø 26mm shaft ø 5x5mm shaft flat black H 20mm L 36mm		



1

Part No.	111364	Ref. No.	3529-133 899 4529-133 789 911-737 000
description	knob switch zero mark t.max.°C ø 40mm shaft ø 5x5mm shaft flat black		



1

Part No.	111368	Ref. No.	4529-132 427
description	knob zero mark ø 31mm shaft ø 5x5mm black		

steam/water taps

steam/water taps



1

Part No.	111360	Ref. No.	3529-132 435
description	handle ø 39mm L 45mm black thread Tr18x2		



1

Part No.	531179	Ref. No.	N/A
description	coffee beans container without lid ø 207mm H 245mm universal		
accessories for	531179		
	Part No.	527327	Ref. No. N/A
	lid for coffee beans container ø 210mm		

supports



1

Part No.	531167	Ref. No.	N/A
description	support for coffee beans container intake conical seat ø 55.5-55mm suitable for FAEMA		

for dishwashers

drain and intake components

miscellaneous

overflow pipes





1

Part No.	519584	Ref. No.	124724 802111002 802131039 977073000
description	overflow pipe L 90mm ø 27mm		



			
1			
Part No.	111370	Ref. No.	4529-134 612
description	knob zero mark ø 31mm shaft ø 8x5.5mm shaft flat right black		

			
1			
Part No.	111366	Ref. No.	902-033 000 924-828 000
description	turning handle ø 24mm L 45mm shaft 6x5mm black		

			
1			
Part No.	111367	Ref. No.	3538-133 797 3538-133 797 BM
description	turning handle ø 30mm L 29mm shaft ø 6x5mm dark blue/chrome		

			
1			
Part No.	111362	Ref. No.	3529-134 824 495-764 000
description	turning handle ø 42mm L 62mm shaft ø 8mm black		

knob dial plates

			
1			
Part No.	111361	Ref. No.	4529-132 464
description	handle ø 44mm L 27mm black		

			
1			
Part No.	111356	Ref. No.	4529-134 741
description	symbol steam ø 39mm L 29mm push-in		

handles and hand wheels

cone handles

			
1			
Part No.	111363	Ref. No.	4741-135 910
description	cone handle thread M10 ø 28mm L 46mm black		

lever handles

			
1			
Part No.	111450	Ref. No.	4831132313DX 911563010
description	slide mounting pos. right		

miscellaneous

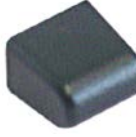
			
1			
Part No.	111031	Ref. No.	4529-132 819
description	handle for steam tap black suitable for FAEMA DUE		

			
1			
Part No.	111799	Ref. No.	911736000 930020010
description	handle without symbol black		

accessories

			
1			
Part No.	525354	Ref. No.	4081-132 841
description	press ring for handle ID ø 9mm		

gaskets

O-rings

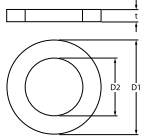
 			
1			
Part No.	528485	Ref. No.	4701-134 861 530-501 200
description	O-ring EPDM thickness 1.78mm ID ø 6.07mm Qty 1 pcs		

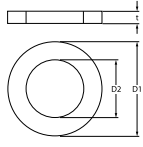
1

Part No.	525310	Ref. No.	4701-030 708
description	O-ring EPDM thickness 1.9mm ID ø 4.2mm Qty 1 pcs		

1

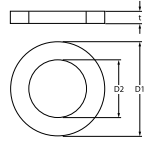
Part No.	525312	Ref. No.	4701-119 817
description	O-ring Viton thickness 1.78mm ID ø 17.17mm Qty 1 pcs		

1

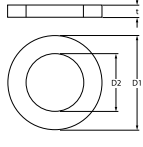
Part No.	526824	Ref. No.	4701-117 916
description	O-ring EPDM thickness 1.9mm ID ø 5.7mm Qty 1 pcs		

1

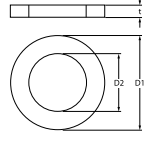
Part No.	532582	Ref. No.	4701-026 914
description	O-ring Viton thickness 1.78mm ID ø 23.52mm Qty 1 pcs		

1

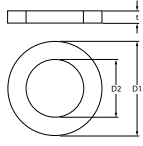
Part No.	529412	Ref. No.	400-279 000
description	O-ring EPDM thickness 2.62mm ID ø 10.78mm Qty 1 pcs		

1

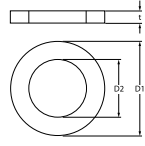
Part No.	101526	Ref. No.	400-293000
description	O-ring Viton thickness 1.78mm ID ø 4.48mm Qty 1 pcs		

1

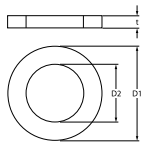
Part No.	529544	Ref. No.	401-320 000
description	O-ring EPDM thickness 2.62mm ID ø 7.59mm Qty 1 pcs		

1

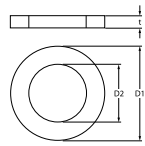
Part No.	101527	Ref. No.	401-371 000 4701-030 138
description	O-ring Viton thickness 1.78mm ID ø 6.75mm Qty 1 pcs		

Viton

1

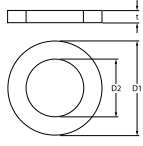
Part No.	525313	Ref. No.	4701-030 129 915-117 000
description	O-ring Viton ID ø 60.33mm thickness 3.53mm Qty 1 pcs		

1

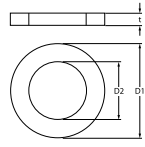
Part No.	528402	Ref. No.	402-206 000 4701-114 266
description	O-ring Viton thickness 2.62mm ID ø 10.78mm Qty 1 pcs		

1

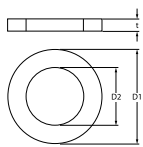
Part No.	528833	Ref. No.	401-204 000 4701-134 887
description	O-ring Viton thickness 1.78mm ID ø 11.11mm Qty 1 pcs		

1

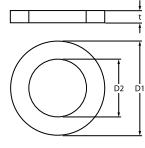
Part No.	532583	Ref. No.	4701-135 932
description	O-ring Viton thickness 2.62mm ID ø 17.86mm Qty 1 pcs		

1

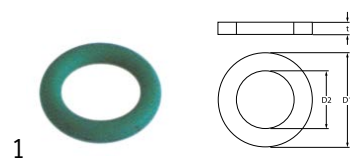
Part No.	528350	Ref. No.	4701-116 687
description	O-ring Viton thickness 2.62mm ID ø 9.13mm Qty 1 pcs		

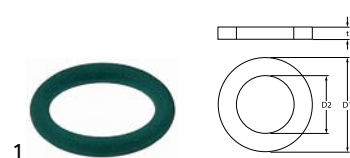

1

Part No.	528525	Ref. No.	4701-135 898
description	O-ring Viton thickness 3.53mm ID ø 18.64mm Qty 1 pcs		

sealing washers

rubber gaskets



1

Part No.	526796	Ref. No.	4701-135 903
description	gasket rubber ED ø 15mm ID ø 7.5mm thickness 4mm Qty 1 pcs		

copper gaskets

DIN-7603-C



1

Part No.	526433	Ref. No.	4701-024 554
description	gasket copper ED ø 18mm ID ø 14mm thickness 2mm		



1

Part No.	528501	Ref. No.	4701-024 558
description	gasket copper ED ø 22mm ID ø 16mm thickness 3mm		

PTFE gaskets



1

Part No.	525306	Ref. No.	4701-116 692
description	flat gasket PTFE ED ø 16.5mm ID ø 12.5mm thickness 0.5mm Qty 1 pcs		



1

Part No.	527154	Ref. No.	4701-135 891
description	flat gasket PTFE ED ø 22mm ID ø 16.8mm thickness 2mm Qty 1 pcs		



1

Part No.	525304	Ref. No.	401-183 000 401-183 010
description	flat gasket PTFE ED ø 22mm ID ø 17mm thickness 1.5mm Qty 1 pcs		



1

Part No.	525303	Ref. No.	400-335 000 400-335 010 4701-024 552
description	flat gasket PTFE ED ø 24.5mm ID ø 21mm thickness 1.5mm Qty 1 pcs		



1

Part No.	525305	Ref. No.	4701-116 694
description	flat gasket PTFE ED ø 26mm ID ø 20.5mm thickness 0.5mm Qty 1 pcs		



1

Part No.	525778	Ref. No.	4701-136 003
description	flat gasket PTFE ED ø 26mm ID ø 22mm thickness 2mm Qty 1 pcs		



1

Part No.	528524	Ref. No.	4701-135 912
description	flat gasket PTFE ED ø 36.5mm ID ø 30.5mm thickness 2mm Qty 1 pcs		



1

Part No.	528002	Ref. No.	N/A
description	flat gasket PTFE ED ø 57mm ID ø 42mm thickness 3mm Qty 1 pcs equiv. no. 12001/W10470 suitable for		



silicone gaskets



Part No.	508398	Ref. No.	0000124578 802011008 984272000
description	flat gasket silicone ED ø 48mm ID ø 38mm thickness 3mm Qty 1 pcs		

special gaskets

group gaskets



Part No.	525311	Ref. No.	4701-135 888
description	group gasket L 77mm W 72mm thickness 2mm aperture 9mm hole distance 56mm suitable for FAEMA PTFE		



Part No.	528115	Ref. No.	N/A
description	group gasket L 79mm W 72mm thickness 2mm hole distance 55mm suitable for FAEMA/FUTURMAT fibre		



Part No.	528113	Ref. No.	N/A
description	group gasket L 80mm W 23mm thickness 2mm suitable for FAEMA/FUTURMAT		

springs

torsion springs



Part No.	526291	Ref. No.	4731-133 581
description	spring ø 27mm wire gauge ø 2mm Qty 1 pcs right		



Part No.	526478	Ref. No.	4731-133 582
description	torsion spring ø 26mm wire gauge ø 2mm Qty 1 pcs left		

compression springs



Part No.	528503	Ref. No.	4731-103 918
description	compression spring ø 10.5mm L 32mm wire gauge ø 1.4mm		



Part No.	526293	Ref. No.	4731117451
description	compression spring ø 10mm L 60mm wire gauge ø 0.7mm for coffee press		



Part No.	525317	Ref. No.	485-061 010 F485-061 010
description	compression spring ø 11mm L 23.5mm wire gauge ø 1.9mm		



Part No.	528509	Ref. No.	4731-030 495
description	compression spring ø 11mm L 31mm wire gauge ø 1.2mm windings 9		



Part No.	525323	Ref. No.	4731-135 884
description	compression spring ø 11mm L 32mm wire gauge ø 1.7mm windings 7 E61		



Part No.	526295	Ref. No.	4731-133 593
description	compression spring ø 12.6mm L 76mm wire gauge ø 1mm		



Part No.	528510	Ref. No.	4731-132 350
description	compression spring ø 13mm L 18mm wire gauge ø 2mm		





Part No.	525321	Ref. No.	4731-135 896
description	compression spring ø 13mm L 37.5mm wire gauge ø 1.1mm windings 7 E61 series LEGEND		





			
1			
Part No.	528533	Ref. No.	4731-135 917
description	compression spring ø 14.6mm L 43mm wire gauge ø 1.4mm		

			
1			
Part No.	528475	Ref. No.	4731-135 918
description	compression spring ø 14.7mm L 33mm wire gauge ø 2mm		

			
1			
Part No.	525322	Ref. No.	4731-022 508
description	compression spring ø 14mm L 24mm wire gauge ø 1.5mm windings 6		

			
1			
Part No.	525319	Ref. No.	4731-135 883
description	compression spring ø 15mm L 17mm wire gauge ø 1.8mm windings 5 E61		

			
1			
Part No.	528542	Ref. No.	4731-135 905
description	compression spring ø 15mm L 27mm wire gauge ø 1.8mm windings 5		

			
1			
Part No.	529701	Ref. No.	4731-109 279
description	compression spring ø 25.7mm L 13mm wire gauge ø 1.9mm		

			
1			
Part No.	526292	Ref. No.	4731-133 577
description	compression spring ø 3.7mm L 20mm wire gauge ø 0.3mm		

			
1			
Part No.	526294	Ref. No.	4731-027 432
description	compression spring ø 5mm L 24mm wire gauge ø 0.4mm Qty 20		
For models:	MC90		

			
1			
Part No.	525320	Ref. No.	4731-027 556
description	compression spring ø 6.6mm L 20.5mm wire gauge ø 0.5mm windings 11		

			
1			
Part No.	528566	Ref. No.	4731-023 460
description	compression spring ø 7.6mm L 26mm wire gauge ø 0.8mm		
For models:	MC90		

			
1			
Part No.	528521	Ref. No.	4731-135 893
description	compression spring ø 8.3mm L 19mm wire gauge ø 0.9mm windings 5		

tension springs

			
1			
Part No.	526297	Ref. No.	4731-117 495
description	tension spring ø 6mm total length 44mm wire gauge ø 0.6mm L1 9.8mm		
For models:	MC90		

			
1			
Part No.	526296	Ref. No.	4731-131 784
description	tension spring ø 9mm total length 51.5mm wire gauge ø 0.8mm L1 31mm		
For models:	MC90		

manometers

			
1			
Part No.	541203	Ref. No.	3781132064 3781133764
description	manometer double scale ø 63mm pressure range 0-2.5 / 0-15bar connection on the backside thread 1/8"		



			
1			
Part No.	541202	Ref. No.	N/A
description	manometer double scale ø 63mm pressure range 0-3 / 0-15bar connection on the backside thread 1/8"		

			
1			
Part No.	541201	Ref. No.	3781135801
description	manometer ø 53.5mm pressure range 0 up to 16bar connection on the backside thread 1/8"		

			
1			
Part No.	541206	Ref. No.	3781118740 3781133399 3781133401
description	manometer ø 42mm pressure range 0 up to 16bar thread 1/8" marking 12 connection on the backside		

fastening material

screws

sheet metal screws

			
1			
Part No.	560323	Ref. No.	4004048325
description	sheet metal screws ø 2.9mm L 19mm SS Qty 20 pcs DIN 7981/ISO 7049 head ø 5.6mm oval head		
For models:	MC90		

			
1			
Part No.	541200	Ref. No.	3781135802
description	manometer ø 52mm pressure range 0 up to 3bar connection on the backside marking 0.7-1 thread 1/8"		

countersunk screws

			
1			
Part No.	560370	Ref. No.	503-605 160
description	countersunk screw thread M5 L 16mm stainless steel DIN 965/ISO 7046 Qty 1 pcs intake Phillips head ø 9mm		

			
1			
Part No.	541282	Ref. No.	N/A
description	manometer ø 52mm pressure range 0 up to 3bar connection on the backside marking 1.5 thread 1/4"		

flat-headed bolts

			
1			
Part No.	560395	Ref. No.	4004-041 348 4004-041 482
description	flat-headed bolt thread M4 thread L 8mm SS DIN 84/ISO 1207 Qty 1 pcs intake slotted head ø 7mm head thickness 2.5mm		
For models:	MC90		

			
1			
Part No.	541248	Ref. No.	3320019
description	manometer ø 52mm pressure range 0 up to 3bar marking 1.6 thread 1/8"		

			
1			
Part No.	560400	Ref. No.	4004-041 359
description	flat-headed bolt thread M5 thread L 8mm SS DIN 84/ISO 1207 Qty 1 pcs intake slotted head ø 8.3mm head thickness 3.2mm		



hexagonal screws

 <p>1</p>			
Part No.	560079	Ref. No.	4004-041 042
description	hexagonal screw thread M6 thread L 12mm SS WS 10 Qty 20 pcs DIN 933 / ISO 4017		

 <p>1</p>			
Part No.	560554	Ref. No.	4814132319
description	hexagonal screw thread M6 thread L 11mm ED ø 6mm chrome-plated brass WS 8 Qty 1 pcs		

cylinder head bolts

DIN 912/ISO 4762

 <p>1</p>			
Part No.	560025	Ref. No.	4001-051 934 4001-051 935 511804120
description	cylinder head bolt thread M4 thread L 10mm WS 3 SS Qty 20 pcs DIN 912/ISO 4762		

 <p>1</p>			
Part No.	560418	Ref. No.	4001-135 922
description	cylinder head bolt thread M6 thread L 8mm L 14mm WS 5 SS Qty 1 pcs intake hexagonal DIN 912/ISO 4762		

grub screws

DIN 913/ISO 4026

 <p>1</p>			
Part No.	560419	Ref. No.	4003-042 353
description	grub screw thread M8 L 10mm stainless steel DIN 913 intake hexagonal WS 4 Qty 1 pcs		

nuts

cap nuts

 <p>1</p>			
Part No.	560137	Ref. No.	4038-135 913
description	cap nuts thread M6 WS 10 SS Qty 20 pcs DIN/ISO DIN 1587		

hexagonal nuts

DIN 985

 <p>1</p>			
Part No.	560553	Ref. No.	4034052287
description	hexagonal nut thread M6 H 8mm SS WS 8 self-locking Qty 1 pcs		

hexagonal nuts metric (without norm)

 <p>1</p>			
Part No.	560502	Ref. No.	4034008834
description	hexagonal nut thread M12x1.5 H 6mm WS 19 SS Qty 1 pcs zinc-plated		
For models:	MC90		

washers

washers

DIN 9021

 <p>1</p>			
Part No.	560120	Ref. No.	4054-043 423
description	plain washer ID ø 6.4mm ED ø 24mm thickness 2mm SS Qty 20 pcs DIN 9021 for thread M6		

miscellaneous

 <p>1</p>			
Part No.	560501	Ref. No.	4054043141
description	plain washer ID ø 12.4mm ED ø 25mm thickness 1.5mm SS Qty 1 pcs		
For models:	MC90		



			
1			
Part No.	525307	Ref. No.	590-715 000
description	plain washer ID ø 13mm ED ø 22mm thickness 1.2mm SS Qty 1 pcs		

			
1			
Part No.	525316	Ref. No.	4051-052 071
description	plain washer ID ø 16.3mm ED ø 27mm thickness 1mm brass Qty 1 pcs for thread M16		

			
1			
Part No.	525308	Ref. No.	4051-136 004
description	plain washer ID ø 6.4mm ED ø 11mm thickness 1.5mm SS Qty 1 pcs		

			
1			
Part No.	528522	Ref. No.	4041-136 010 4051-135 889
description	plain washer ID ø 6.7mm ED ø 10.8mm thickness 1mm brass Qty 1 pcs		

			
1			
Part No.	525314	Ref. No.	4051-047 130
description	plain washer ID ø 7.5mm ED ø 15mm thickness 1mm brass Qty 1 pcs		

fasteners

retaining rings

DIN 471

			
1			
Part No.	529702	Ref. No.	4081-050 302
description	retaining ring spindle shaft ø 16mm thickness 1mm steel DIN 471		

DIN 472

			
1			
Part No.	528518	Ref. No.	568-101 000
description	retaining ring bore ø 22mm thickness 1.2mm steel DIN 472		

DIN 6799			
			
1			
Part No.	528709	Ref. No.	568204051
description	retaining ring E D1 ø 4mm D2 ø 9mm steel DIN 6799 thickness 0.7mm for shaft ø 5-7mm		

cotter pins			
			
1			
Part No.	695209	Ref. No.	4061-024 965
description	cotter pin ø 2mm L 20mm SS		

consumables

fuses

fine fuses

			
1			
Part No.	358661	Ref. No.	3501-117 399
description	fine fuse size ø5x20mm 0.1A fast-acting rated 250V Qty 10 pcs		

			
1			
Part No.	358677	Ref. No.	3501-117 396
description	fine fuse size ø5x20mm 4A fast-acting rated 250V Qty 10 pcs		

			
1			
Part No.	358533	Ref. No.	530-115 100
description	fine fuse size ø5x20mm 6.3A fast-acting rated 250V Qty 10 pcs		

			
1			
Part No.	358509	Ref. No.	3501-091 867
description	fine fuse size ø5x20mm 0.05A slow-acting rated 250V Qty 1 pcs		



			
1			
Part No.	358596	Ref. No.	3501-117 398
description	fine fuse size ø5x20mm 0.25A slow-acting rated 250V Qty 10 pcs		

GASTROPARTS.COM

