



**GASTROPARTS**

# Eurast

- [EN]** Equipment
- [DE]** Geräte
- [ES]** Aparatos
- [FR]** Équipement
- [IT]** Attrezzature
- [PL]** Urządzenia
- [RU]** Оборудование

✉ [gastroparts@gastroparts.com](mailto:gastroparts@gastroparts.com)

☎ +48 56 657 00 66

📘 [fb.com/gastroparts.global](https://fb.com/gastroparts.global)

**GASTROPARTS.COM**





## heating elements

### heating elements for ovens

|                    |   |                 |      |
|--------------------|---|-----------------|------|
|                    |   |                 |      |
| 1                  |   |                 |      |
| <b>Part No.</b>    | 419068  | <b>Ref. No.</b> | 2127 |
| <b>description</b> | heating element 2400W 230V heating circuits 3 L 505mm W 355mm<br>L1 55mm L2 450mm W1 114mm W2 127mm flange length 170mm<br>flange width 45mm hole distance 138mm bridge length 368mm hole ø<br>12/7mm tube ø 8mm connection M4 connection length 30mm<br>windings 4 rectangular flange dry heating element oven |                 |      |
| <b>For models:</b> | H1BPE, S4SHE  |                 |      |

|                    |   |                 |      |
|--------------------|---|-----------------|------|
|                    |   |                 |      |
| 1                  |   |                 |      |
| <b>Part No.</b>    | 419069  | <b>Ref. No.</b> | 2131 |
| <b>description</b> | heating element 4000W 230V heating circuits 3 L 505mm W 510mm<br>L1 55mm L2 450mm W1 191.5mm W2 127mm flange length 170mm<br>flange width 45mm hole distance 138mm bridge length 520mm hole ø<br>12/7mm tube ø 8mm connection M4 connection length 30mm<br>windings 6 rectangular flange dry heating element oven |                 |      |
| <b>For models:</b> | H4HE  |                 |      |

### heating elements for fryers

#### 2 hole fixing

#### group 2

|                    |  |                 |      |
|--------------------|--|-----------------|------|
|                    |  |                 |      |
| 1                  |  |                 |      |
| <b>Part No.</b>    | 419070   | <b>Ref. No.</b> | 2180 |
| <b>description</b> | heating element 2200W 230V heating circuits 1 L 300mm W 110mm<br>H 170mm L1 35mm L2 15mm L3 250mm thread M12x1.25 mounting<br>distance 102mm tube ø 8mm windings 3 2 hole fixing connection M4<br>connection length 35mm fryer cover |                 |      |
| <b>For models:</b> | FRF10-2, FRF5  |                 |      |

#### group 5

|                    |   |                 |          |
|--------------------|---|-----------------|----------|
|                    |   |                 |          |
| 1                  |   |                 |          |
| <b>Part No.</b>    | 419067  | <b>Ref. No.</b> | 65720019 |
| <b>description</b> | heating element 3000W 220V heating circuits 1 L 300mm W 205mm<br>H 180mm 2 hole fixing connection M4 fryer heaters L1 35mm L2<br>15mm L3 250mm W1 42.5mm W2 120mm tube ø 8.5mm thread<br>M12x1 mounting distance 112mm connection length 38mm windings<br>5 |                 |          |
| <b>For models:</b> | FRF10-2, FRF162, FRF16-2, FRF24-2, FRF8   |                 |          |

### ceramic heaters

#### 245x60mm

|                        |  |  |        |
|------------------------|--|--|--------|
|                        |  |  |        |
| 1                      |  |  |        |
| <b>Part No.</b>        | 415102   | <b>Ref. No.</b>  | 2088   |
| <b>description</b>     | ceramic emitter 400W 230V cable beaded cord L 245mm W 60mm<br>H 35mm |  |        |
| <b>For models:</b>     | SCE  |  |        |
| <b>spare parts for</b> | 415102   |  |        |
|                        |  | <b>Part No.</b>  | 415109 |
|                        |  | <b>Ref. No.</b>  | —      |
|                        |  | spring clip  |        |
| <b>accessories for</b> | 415102   |  |        |
|                        |  | <b>Part No.</b>  | 415110 |
|                        |  | <b>Ref. No.</b>  | —      |
|                        |  | reflector L 245mm W 95mm H 31mm thickness 0.75mm hole ø<br>15x40mm |        |

### coil heating elements

|                    |   |                 |      |
|--------------------|---|-----------------|------|
|                    |   |                 |      |
| 1                  |   |                 |      |
| <b>Part No.</b>    | 419071  | <b>Ref. No.</b> | 2264 |
| <b>description</b> | heating element 1000W 230V L 370mm W 50mm H 25mm tube ø<br>8mm thread M12x1.25 connection M4 connection length 30mm dry<br>heating element heating circuits 1 2 hole fixing |                 |      |
| <b>For models:</b> | SCE   |                 |      |



## radiation heaters

|   |   |                 |          |
|---|---|-----------------|----------|
|  |   |                 |          |
| 1   |   |                 |          |
| <b>Part No.</b>   | 419076  | <b>Ref. No.</b> | 97032038 |
| <b>description</b>  | heating element rectangular L 840mm W 190mm 2500W 230/400V H 40mm cable length 450mm chicken rotisserie |                 |          |
| <b>For models:</b>  | 105, 105E, 1260, 1260E, 1680, 1680E, 210, 210E, 315, 315E, 420, 420E, 630, 630E, 840, 840E              |                 |          |

## foil heating elements

|   |  |                 |          |
|---|--|-----------------|----------|
|  |  |                 |          |
| 1   |  |                 |          |
| <b>Part No.</b>   | 419075   | <b>Ref. No.</b> | C5421210 |
| <b>description</b>  | foil heating element L 400mm W 290mm 1000W 230V t.max. 150°C silicone cable length 2000mm thickness 1mm bain marie |                 |          |
| <b>For models:</b>  | BMR311, HBE, HMBE, RBE, RMBE, SBME   |                 |          |

## accessories

## capillary tube clips

|   |   |                 |          |
|---|---|-----------------|----------|
|  |   |                 |          |
| 1   |   |                 |          |
| <b>Part No.</b>   | 550138  | <b>Ref. No.</b> | 68560069 |
| <b>description</b>  | capillary tube clip for pipe ø 8.5mm for circular tube heating elements |                 |          |
| <b>For models:</b>  | FRF10-2, FRF12, FRF16-2, FRF24-2, FRF5, FRF8                            |                 |          |

## spring clips

|   |  |                 |          |
|---|--|-----------------|----------|
|  |  |                 |          |
| 1   |  |                 |          |
| <b>Part No.</b>   | 551078   | <b>Ref. No.</b> | 69340099 |
| <b>description</b>  | probe spring for pipe ø 8mm for probe ø 5mm L 30mm W 10mm wire gauge ø 1mm |                 |          |
| <b>For models:</b>  | FRF10-2, FRF12, FRF16-2, FRF24-2, FRF5, FRF8                               |                 |          |



## hot plates

## round

## with radiused edge

## for domestic and commercial kitchens

|  |  |                 |      |
|--|--|-----------------|------|
|  |  |                 |      |
| 1  |  |                 |      |
| <b>Part No.</b>  | 490018   | <b>Ref. No.</b> | 3216 |
| <b>description</b>   | hot plate ø 220mm 2000W 230V connection 4 screw clamps with 8mm spill ring |                 |      |
| <b>For models:</b>   | S4E, S4SHE   |                 |      |

|  |  |                 |        |
|--|--|-----------------|--------|
|  |  |                 |        |
| 1  |  |                 |        |
| <b>Part No.</b>  | 490020   | <b>Ref. No.</b> | 3235   |
| <b>description</b>   | hot plate ø 220mm 2600W 230V connection 4 screw clamps with 8mm spill ring         |                 |        |
| <b>For models:</b>   | S4E, S4SHE   |                 |        |
| <b>accessories for</b>   | 490020   |                 |        |
|  |  | <b>Part No.</b> | 550796 |
|  |  | <b>Ref. No.</b> | —      |
|  | fixing plate for hot plate ø220mm  |                 |        |

## energy regulators

## EGO

## 1-circuit

|  |   |                 |          |
|--|---|-----------------|----------|
|  |   |                 |          |
| 1  |   |                 |          |
| <b>Part No.</b>  | 380015  | <b>Ref. No.</b> | C5322489 |
| <b>description</b>   | energy regulator 230V 13A single-circuit turn direction right shaft ø 6x4.6mm shaft L 23mm mounting thread M4 power release 6-100% no. 50.57021.010 |                 |          |
| <b>For models:</b>   | 105, 105E, 1155, 1260, 1260E, 1575, 1680, 1680E, 210, 210E, 315, 315E, 420, 420E, 630, 630E, 840, 840E  |                 |          |



## thermostats

### control and safety thermostats

EGO

control thermostats

55.13\_ series



1

|                    |  |                 |      |
|--------------------|--|-----------------|------|
| <b>Part No.</b>    | 375505   | <b>Ref. No.</b> | 2221 |
| <b>description</b> | thermostat t.max. 320°C temperature range 50-320°C 1-pole 1NO 16A probe ø 3mm probe L 160mm capillary pipe 870mm capillary pipe isolatedmm gland nut shaft ø 6x4.6mm shaft L 23mm shaft position upper rotation 270° |                 |      |
| <b>For models:</b> | H1BE, H1BPE, H1TE, H2BE, H4HE, H8HE, R1TCE, S4SHE, SP12CE, SP4CE, SP8CE  |                 |      |

### IMIT / TEMPOMATIC / ARTHERMO

control thermostats



1

|                    |  |                 |          |
|--------------------|--|-----------------|----------|
| <b>Part No.</b>    | 375939   | <b>Ref. No.</b> | C5322059 |
| <b>description</b> | thermostat t.max. 200°C temperature range 0-200°C 1-pole 1CO 16A probe ø 5mm probe L 98mm capillary pipe 1040mm capillary pipe isolatedmm gland nut shaft ø 6x4.6mm shaft L 20mm |                 |          |
| <b>For models:</b> | FRF102, FRF10-2, FRF12, FRF162, FRF16-2, FRF20, FRF242, FRF24-2, FRF5, FRF8  |                 |          |

safety thermostats



1

|                    |  |                 |          |
|--------------------|--|-----------------|----------|
| <b>Part No.</b>    | 375941   | <b>Ref. No.</b> | C5322209 |
| <b>description</b> | safety thermostat switch-off temp. 238°C 1-pole 1NC 16A probe ø 5mm probe L 100mm capillary pipe 1050mm capillary pipe isolatedmm gland nut 250V |                 |          |
| <b>For models:</b> | FRF102, FRF10-2, FRF12, FRF162, FRF16-2, FRF20, FRF242, FRF24-2, FRF5, FRF8  |                 |          |

various

control thermostats



1

|                    |   |                 |          |
|--------------------|---|-----------------|----------|
| <b>Part No.</b>    | 375940  | <b>Ref. No.</b> | C5322579 |
| <b>description</b> | thermostat temperature range 30-90°C 1-pole 1CO 16A probe ø 6mm probe L 108mm capillary pipe 1530mm shaft ø 6x4.6mm shaft L 12mm rotation 270° 400V |                 |          |
| <b>For models:</b> | HBE, HMBE, RBE, RMBE, SBME, SCE   |                 |          |

safety thermostats



1

|   |  |                 |                 |
|---|--|-----------------|-----------------|
| <b>Part No.</b>   | 390754   | <b>Ref. No.</b> | 92011140        |
| <b>description</b>  | safety thermostat switch-off temp. 240°C 1-pole 0.5A probe ø 6mm probe L 79mm capillary pipe 860mm capillary pipe isolated 750mm probe thread M10x1 connection with cable cable length 600mm |                 |                 |
| <b>For models:</b>  | SF10EG, SF20EG   |                 |                 |
| <b>spare parts for</b>  | 390754   |                 |                 |
|  | <b>Part No.</b>  | 375783          | <b>Ref. No.</b> |
|   |  |                 | —               |
|   | safety thermostat switch-off temp. 240°C 1-pole 0.5A probe ø 6mm probe L 77mm capillary pipe 860mm capillary pipe isolated 750mm gland nut M10x1 probe SS                                    |                 |                 |

### accessories

capillary tube clips



1

|                    |   |                 |          |
|--------------------|---|-----------------|----------|
| <b>Part No.</b>    | 550138  | <b>Ref. No.</b> | 68560069 |
| <b>description</b> | capillary tube clip for pipe ø 8.5mm for circular tube heating elements |                 |          |
| <b>For models:</b> | FRF10-2, FRF12, FRF16-2, FRF24-2, FRF5, FRF8                            |                 |          |



## switches and momentary switches

## rocker/momentary rocker switches

ø20mm



1

|                    |  |                 |          |
|--------------------|--|-----------------|----------|
| <b>Part No.</b>    | 357074   | <b>Ref. No.</b> | C5120729 |
| <b>description</b> | rocker switch mounting measurements 20mm red 2NO 250V 10A I O connection male faston 4.8mm ambient temperature max. 85°C protection IP40   |                 |          |
| <b>For models:</b> | 105, 105E, 1155, 1260, 1260E, 1575, 1680, 1680E, 210, 210E, 315, 315E, 420, 420E, 630, 630E, 840, 840E, AC10G, AF02, AF04, AF04G, AF12, AM20G, GH2P, H1BE, H1BPE, H2BE, H4HE, H8HE, S4SHE, SCE, TF2PG, TF3PG |                 |          |

## cam switches

4-position

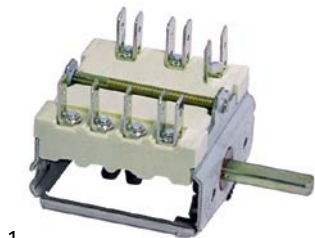

1

|                    |  |                 |      |
|--------------------|--|-----------------|------|
| <b>Part No.</b>    | 300007   | <b>Ref. No.</b> | 3218 |
| <b>description</b> | cam switch 4 operating positions 1NO/2CO sequence 0-1-2-3 16A shaft ø 6x4.6mm shaft L 23mm connection male faston 6.3mm 4-position ceramic |                 |      |
| <b>For models:</b> | H4HE, H8HE, S2E, S4E, S4SHE  |                 |      |

## lamps

## indicator lights

## indicator lights (complete)

ø 6mm



1

|                    |   |                 |          |
|--------------------|---|-----------------|----------|
| <b>Part No.</b>    | 357072  | <b>Ref. No.</b> | C5120219 |
| <b>description</b> | indicator light ø 6mm 220V red connection cable 300mm cable length 300mm metal  |                 |          |
| <b>For models:</b> | 105, 105E, 1155, 1260, 1260E, 1575, 1680, 1680E, 210, 210E, 315, 315E, 420, 420E, 630, 630E, 840, 840E, FRF10-2, FRF12, FRF16-2, FRF24-2, FRF5, FRF8, H1BE, H1BPE, H1TE, H2BE, H4HE, H8HE, HBE, HMBE, HMI150E, R1TCE, RBE, RMBE, S2E, S4E, S4SHE, S4VE, SBME, SCE, SP12CE, SP4CE, SP8CE |                 |          |

ø20mm



1

|                    |  |                 |          |
|--------------------|--|-----------------|----------|
| <b>Part No.</b>    | 357073   | <b>Ref. No.</b> | C5120719 |
| <b>description</b> | indicator light ø 20mm 250V red connection male faston 4.8mm temp.-resist. 105°C |                 |          |
| <b>For models:</b> | AC10G, AF02, AF04, AF04G, AF12, AM20G, GH2P, TF2PG, TF3PG                        |                 |          |





## oven lamps

## universal oven lamps

55x100mm



1

|   |   |                 |                 |   |
|---|---|-----------------|-----------------|---|
| <b>Part No.</b>   | 101372  | <b>Ref. No.</b> | C5125419        |   |
| <b>description</b>  | oven lamp complete L 100mm W 55mm 230V 25W socket E14 rectangular temp.-resist. 300°C connection male faston 6.3mm      |                 |                 |   |
| <b>For models:</b>  | 105, 105E, 1155, 1260, 1260E, 1575, 1680, 1680E, 210, 210E, 315, 315E, 420, 420E, 630, 630E, 636P, 840, 840E, 848P, A4E |                 |                 |   |
| <b>spare parts for</b>  | 101372  |                 |                 |   |
|  | <b>Part No.</b>   | 359612          | <b>Ref. No.</b> | — |
|   | light bulb t.max. 300°C socket E14 25W 230V ø 25mm L 56mm lens L 30mm for oven lamp type Philips                        |                 |                 |   |
|  | <b>Part No.</b>   | 359698          | <b>Ref. No.</b> | — |
|   | lamp socket L 100mm W 55mm socket E14 connection male faston 6.3mm  |                 |                 |   |
|  | <b>Part No.</b>   | 359714          | <b>Ref. No.</b> | — |
|   | gasket for bulb socket  |                 |                 |   |
|  | <b>Part No.</b>   | 359715          | <b>Ref. No.</b> | — |
|   | lamp glass L 110mm W 65mm thickness 5mm   |                 |                 |   |
|  | <b>Part No.</b>   | 359716          | <b>Ref. No.</b> | — |
|   | frame for bulb socket   |                 |                 |   |



## contactors

### LS Industrial Systems

#### power contactors



1

|                    |   |                 |          |
|--------------------|---|-----------------|----------|
| <b>Part No.</b>    | 380944  | <b>Ref. No.</b> | C5123179 |
| <b>description</b> | power contactor resistive load 20A 230VAC (AC3/400V) 12A/5.5kW main contacts 3NO auxiliary contacts 1NO/1NC connection screw connection type GMC-12 |                 |          |
| <b>For models:</b> | H1BE, H1TE, H2BE, R1TCE   |                 |          |

## electronic controllers

### miscellaneous

#### refrigeration controllers



1

|                    |  |                 |          |
|--------------------|--|-----------------|----------|
| <b>Part No.</b>    | 378271   | <b>Ref. No.</b> | C5322529 |
| <b>description</b> | electronic controller OSAKA type T2001 AN /HSH5 mounting measurements 71x29mm 100-240V voltage AC NTC display 4 digits NTC/PTC |                 |          |
| <b>For models:</b> | AC10G, AF02, AF04, AF04G, AF12, AM20G, BMR311, GH2P, MC161E, MC162E, MC201E, MC202E, TF2PG, TF3PG                              |                 |          |

## motors

### gear motors

#### for grills



1

|                    |  |                 |          |
|--------------------|--|-----------------|----------|
| <b>Part No.</b>    | 499110   | <b>Ref. No.</b> | C5020039 |
| <b>description</b> | gear motor CROUZET 230V 50Hz 4rpm shaft ø 6x5mm L 91mm W 64mm H 58mm |                 |          |
| <b>For models:</b> | 105, 105E, 1260, 1680, 210, 315, 420, 630, 840                       |                 |          |



1

|                    |  |                 |         |
|--------------------|--|-----------------|---------|
| <b>Part No.</b>    | 499111   | <b>Ref. No.</b> | 534027P |
| <b>description</b> | gear motor CEG type MM56A4-STD 90W 230V 50Hz 6500rpm L 705mm W 115mm H 550mm chicken rotisserie 0.12HP |                 |         |
| <b>For models:</b> | 1155, 1260, 1260E, 1575, 1680, 1680E, 210, 210E, 315, 315E, 630, 630E, 840, 840E                       |                 |         |

## gas taps

### PEL

#### 20S series



1









|   |  |  |                 |      |
|---|--|--|-----------------|------|
| <b>Part No.</b>   | 106840   | <b>Ref. No.</b>  | 3780            |      |
| <b>description</b>  | gas tap PEL type 20S gas inlet pipe flange ø21mm bypass nozzle ø 0mm gas outlet M16x1.5 (tube ø 10/8mm) thermocouple connection M8x1 pilot connection shaft ø 8x6.5mm shaft L 22/15mm shaft flat upper |  |                 |      |
| <b>For models:</b>  | 105, 105E, 1155, 1260, 1260E, 1575, 1680, 1680E, 210, 210E, 315, 315E, 420, 420E, 630, 630E, 840, 840E   |  |                 |      |
| <b>spare parts for</b>  | 106840   |  |                 |      |
|  | <b>Part No.</b>  | 101060   | <b>Ref. No.</b> | —    |
|   |  | magnet unit standard L 39mm D1 ø 15.4mm D2 ø 11mm suitable for PEL20-21/JUNKERS/EGA          |                 |      |
|  | <b>Part No.</b>  | 101205   | <b>Ref. No.</b> | —    |
|   |  | gas tap front part shaft ø 8x6.5mm shaft L 22/15mm shaft flat upper/lower suitable for PEL20 |                 |      |
|  | <b>Part No.</b>  | 101880   | <b>Ref. No.</b> | —    |
|   |  | gasket Viton ED ø 14mm ID ø 9mm thickness 7.7mm Qty 1 pcs                                    |                 |      |
|  | <b>Part No.</b>  | 106202   | <b>Ref. No.</b> | —    |
|   |  | bypass nozzle type PEL20/21 bore ø 0mm thread M5x0.5   |                 |      |
| <b>accessories for</b>  | 106840   |  |                 |      |
|  | <b>Part No.</b>  | 101230   | <b>Ref. No.</b> | —    |
|   |  | thermocouple nut T1: M8x1 T2: M18x1 aluminium  |                 |      |
|  | <b>Part No.</b>  | 101278   | <b>Ref. No.</b> | 3781 |
|   |  | olive for pipe ø 10mm Qty 1 pcs  |                 |      |
|  | <b>Part No.</b>  | 101300   | <b>Ref. No.</b> | 3782 |
|   |  | union nut thread M16x1.5 tube ø 10mm   |                 |      |
|  | <b>Part No.</b>  | 101450   | <b>Ref. No.</b> | —    |
|   |  | olive for pipe ø 8mm L 12.7mm Qty 1 pcs ED ø 10mm  |                 |      |
|  | <b>Part No.</b>  | 101451   | <b>Ref. No.</b> | —    |
|   |  | union nut thread M16x1.5 tube ø 8mm  |                 |      |



## 21S series







1

|   |  |                 |                          |
|---|--|-----------------|--------------------------|
| <b>Part No.</b>   | 106841   | <b>Ref. No.</b> | C5811429                 |
| <b>description</b>  | gas tap PEL type 21S gas inlet pipe flange $\varnothing$ 21mm bypass nozzle $\varnothing$ 0mm gas outlet M16x1.5 (tube $\varnothing$ 10mm) thermocouple connection M9x1 pilot connection M10x1 shaft $\varnothing$ 8x6.5mm shaft L 22/15mm shaft flat right pipe input $\varnothing$ 9mm |                 |                          |
| <b>For models:</b>  | C8L, H1FV, H1PH, H4H, H6H, HBG, HCP, HGR, HGR2, HM100, HM150, HMI100, HMI150, R2T, R4H, R6L, RBG, RBP, RCP, RM70, S2, S2P, S2SH, S4, S4SH, SBG, SBP  |                 |                          |
| <b>spare parts for</b>  | 106841   |                 |                          |
|    | <b>Part No.</b>  | 101060          | <b>Ref. No.</b> —        |
|   | magnet unit standard L 39mm D1 $\varnothing$ 15.4mm D2 $\varnothing$ 11mm suitable for PEL20-21/JUNKERS/EGA  |                 |                          |
|    | <b>Part No.</b>  | 101231          | <b>Ref. No.</b> —        |
|   | thermocouple nut T1: M9x1 T2: M18x1  |                 |                          |
|    | <b>Part No.</b>  | 106202          | <b>Ref. No.</b> —        |
|   | bypass nozzle type PEL20/21 bore $\varnothing$ 0mm thread M5x0.5   |                 |                          |
| <b>accessories for</b>  | 106841   |                 |                          |
|   | <b>Part No.</b>  | 100908          | <b>Ref. No.</b> —        |
|   | union screw thread M10x1 for pipe $\varnothing$ 4mm Qty 1 pcs  |                 |                          |
|  | <b>Part No.</b>  | 100909          | <b>Ref. No.</b> A1018997 |
|   | union screw thread M10x1 for pipe $\varnothing$ 6mm Qty 1 pcs  |                 |                          |
|  | <b>Part No.</b>  | 101246          | <b>Ref. No.</b> —        |
|   | olive for pipe $\varnothing$ 4mm Qty 1 pcs   |                 |                          |
|  | <b>Part No.</b>  | 101278          | <b>Ref. No.</b> 3781     |
|   | olive for pipe $\varnothing$ 10mm Qty 1 pcs  |                 |                          |
|  | <b>Part No.</b>  | 101286          | <b>Ref. No.</b> —        |
|   | olive ID $\varnothing$ 6mm Qty 1 pcs   |                 |                          |
|  | <b>Part No.</b>  | 101300          | <b>Ref. No.</b> 3782     |
|   | union nut thread M16x1.5 tube $\varnothing$ 10mm   |                 |                          |
|  | <b>Part No.</b>  | 101450          | <b>Ref. No.</b> —        |
|   | olive for pipe $\varnothing$ 8mm L 12.7mm Qty 1 pcs ED $\varnothing$ 10mm  |                 |                          |
|  | <b>Part No.</b>  | 101451          | <b>Ref. No.</b> —        |
|   | union nut thread M16x1.5 tube $\varnothing$ 8mm  |                 |                          |
|  | <b>Part No.</b>  | 110081          | <b>Ref. No.</b> —        |
|   | knob $\varnothing$ 70mm shaft $\varnothing$ 8x6.5mm shaft flat universal   |                 |                          |
|  | <b>Part No.</b>  | 112206          | <b>Ref. No.</b> —        |
|   | knob dial plate silver gas tap PEL21/22/23 t.max. °C ED $\varnothing$ 63mm ID $\varnothing$ 45.5mm   |                 |                          |

## SABAF







1

|   |  |                 |                          |
|---|--|-----------------|--------------------------|
| <b>Part No.</b>   | 106842   | <b>Ref. No.</b> | C5816299                 |
| <b>description</b>  | gas tap SABAF type 10 gas inlet pipe flange $\varnothing$ 23mm bypass nozzle $\varnothing$ 0mm gas outlet 1/4" (tube $\varnothing$ 8mm) front fixing M13x1 thermocouple connection M8x1 shaft $\varnothing$ 8x6.5mm shaft L 32/12.5mm shaft flat right |                 |                          |
| <b>For models:</b>  | 1155, 1575, 315, 420, 630, 636P, 840, 848P, FOK30, FOK60, FOK90, PC100, PC100C, PC100F, PC60, PC60C, PC60F, PC80, PC80C, PC80F   |                 |                          |
| <b>spare parts for</b>  | 106842   |                 |                          |
|    | <b>Part No.</b>  | 101051          | <b>Ref. No.</b> —        |
|   | magnet unit L 27mm D1 $\varnothing$ 12.5mm D2 $\varnothing$ 8.5mm suitable for JUNKERS/EGA/MADEC/SABAF standard  |                 |                          |
|    | <b>Part No.</b>  | 101376          | <b>Ref. No.</b> —        |
|   | gasket ID $\varnothing$ 8mm ED $\varnothing$ 12mm H 3/5mm  |                 |                          |
| <b>accessories for</b>  | 106842   |                 |                          |
|    | <b>Part No.</b>  | 101277          | <b>Ref. No.</b> C5815549 |
|   | olive ID $\varnothing$ 8mm Qty 1 pcs   |                 |                          |
|   | <b>Part No.</b>  | 101751          | <b>Ref. No.</b> —        |
|   | bracket  |                 |                          |
|  | <b>Part No.</b>  | 520656          | <b>Ref. No.</b> —        |
|   | union nut thread 1/4" tube $\varnothing$ 6/8mm   |                 |                          |



1

|   |  |                 |                          |
|---|--|-----------------|--------------------------|
| <b>Part No.</b>   | 106843   | <b>Ref. No.</b> | C5816289                 |
| <b>description</b>  | gas tap SABAF type 10 gas inlet pipe flange $\varnothing$ 23mm bypass nozzle $\varnothing$ 0mm gas outlet 1/4" (tube $\varnothing$ 8mm) front fixing thermocouple connection M8x1 shaft $\varnothing$ 8x6.5mm shaft L 47/12.5mm shaft flat right |                 |                          |
| <b>For models:</b>  | S3SB   |                 |                          |
| <b>spare parts for</b>  | 106843   |                 |                          |
|  | <b>Part No.</b>  | 101051          | <b>Ref. No.</b> —        |
|   | magnet unit L 27mm D1 $\varnothing$ 12.5mm D2 $\varnothing$ 8.5mm suitable for JUNKERS/EGA/MADEC/SABAF standard  |                 |                          |
|  | <b>Part No.</b>  | 101376          | <b>Ref. No.</b> —        |
|   | gasket ID $\varnothing$ 8mm ED $\varnothing$ 12mm H 3/5mm  |                 |                          |
| <b>accessories for</b>  | 106843   |                 |                          |
|  | <b>Part No.</b>  | 101277          | <b>Ref. No.</b> C5815549 |
|   | olive ID $\varnothing$ 8mm Qty 1 pcs   |                 |                          |
|  | <b>Part No.</b>  | 101751          | <b>Ref. No.</b> —        |
|   | bracket  |                 |                          |
|  | <b>Part No.</b>  | 520656          | <b>Ref. No.</b> —        |
|   | union nut thread 1/4" tube $\varnothing$ 6/8mm   |                 |                          |









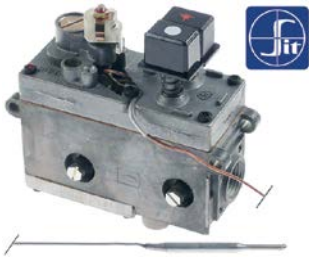











## gas thermostats

### SIT

#### 710 Minisit series



|   |  |                 |                          |
|---|--|-----------------|--------------------------|
| <b>Part No.</b>   | 101132   | <b>Ref. No.</b> | 3103                     |
| <b>description</b>  | gas thermostat SIT type MINISIT 710 t.max. 340°C 100-340°C gas inlet 1/2" gas outlet 3/8" thermocouple connection M9x1 pilot connection M10x1 probe ø 5mm probe L 68mm capillary pipe 1050mm probe type type B1 pressure controller no pressure regulator mbar gland nut ignition gas no |                 |                          |
| <b>For models:</b>  | C8L, H1B, H1FV, H1L, H2B, H4H, H6H, HF20, HSB120, HSB80, R1T, R1TC, R4H, R6L, SP12C, SP4C, SP8C  |                 |                          |
| <b>spare parts for</b>  | 101132   |                 |                          |
|    | <b>Part No.</b>  | 101053          | <b>Ref. No.</b> —        |
|   | magnet unit T1: M9x1 T2: M24x1 L 45mm ø 17mm suitable for Minisit  |                 |                          |
|    | <b>Part No.</b>  | 102102          | <b>Ref. No.</b> —        |
|   | probe 100-340°C probe ø 5mm probe L 68mm capillary pipe 1750mm t.max. 340°C oven/grill probe type type B1 suitable for MINISIT 710   |                 |                          |
| <b>accessories for</b>  | 101132   |                 |                          |
|  | <b>Part No.</b>  | 100809          | <b>Ref. No.</b> 3785     |
|   | O-ring EPDM thickness 2mm ID ø 21mm Qty 1 pcs  |                 |                          |
|  | <b>Part No.</b>  | 100904          | <b>Ref. No.</b> —        |
|   | locking screw M10x1 for pipe ø 4mm Qty 1 pcs   |                 |                          |
|  | <b>Part No.</b>  | 100905          | <b>Ref. No.</b> C5815359 |
|   | locking screw M10x1 for pipe ø 6mm Qty 1 pcs   |                 |                          |
|  | <b>Part No.</b>  | 101054          | <b>Ref. No.</b> —        |
|   | magnet unit T1: M10x1 T2: M24x1 L 45mm ø 17mm suitable for Minisit   |                 |                          |
|  | <b>Part No.</b>  | 101136          | <b>Ref. No.</b> —        |
|   | piezoelectric igniter suitable for Minisit with cover cap ømm connection F6.3x0.8  |                 |                          |
|  | <b>Part No.</b>  | 101137          | <b>Ref. No.</b> —        |
|   | cover cap without piezoelectric igniter  |                 |                          |
|  | <b>Part No.</b>  | 101267          | <b>Ref. No.</b> —        |
|   | reducer IT 3/8" ET 1/2" L 21mm   |                 |                          |
|  | <b>Part No.</b>  | 101268          | <b>Ref. No.</b> —        |
|   | gas connection thread 3/8" angled with O-ring MINISIT 710  |                 |                          |
|  | <b>Part No.</b>  | 101269          | <b>Ref. No.</b> —        |
|   | gas connection thread 1/2" angled with O-ring MINISIT 710  |                 |                          |
|  | <b>Part No.</b>  | 101270          | <b>Ref. No.</b> —        |
|   | screw connection IT 3/8" ET 3/8" L 28mm  |                 |                          |
|  | <b>Part No.</b>  | 101272          | <b>Ref. No.</b> —        |
|   | screw connection IT 1/2" ET 3/8" L 57mm  |                 |                          |

|   |  |        |                   |
|---|--|--------|-------------------|
| <b>accessories for</b>  | 101132   |        |                   |
|  | <b>Part No.</b>  | 101273 | <b>Ref. No.</b> — |
|   | olive for pipe ø 12mm L 9.5mm brass Qty 1 pcs suitable for universal |        |                   |
|  | <b>Part No.</b>  | 101274 | <b>Ref. No.</b> — |
|   | olive for pipe ø 16mm Qty 1 pcs                                      |        |                   |
|  | <b>Part No.</b>  | 101275 | <b>Ref. No.</b> — |
|   | union screw thread 1/2" for pipe ø 16mm Qty 1 pcs                    |        |                   |
|  | <b>Part No.</b>  | 101276 | <b>Ref. No.</b> — |
|   | union screw thread 3/8" tube ø 12mm Qty 1 pcs                        |        |                   |
|  | <b>Part No.</b>  | 110068 | <b>Ref. No.</b> — |
|   | knob suitable for Minisit ø 37mm                                     |        |                   |

## gas valves and ignition boxes

### gas control valves

#### SIT

#### NOVASIT

#### accessories

|  |   |        |                 |          |
|--|---|--------|-----------------|----------|
|  | <b>Part No.</b>   | 100905 | <b>Ref. No.</b> | C5815359 |
|  | locking screw M10x1 for pipe ø 6mm Qty 1 pcs  |        |                 |          |
|  | <b>For models:</b> H1B, H1FV, H1L, H1PH, H2B, H4H, H6H, HBG, HCP, HF20, HF40, HGR, HGR2, HM100, HM150, HMI100, HMI150, HSB120, HSB80, R1T, R1TC, R2T, R4H, R6L, RBG, RBP, RCP, RM70, S2, S2P, S2SH, S4, S4SH, SBG, SBP, SF10EG, SF20EG, SP12C, SP4C, SP8C |        |                 |          |

## ignition parts

### pilot burners

#### SIT

#### 100 series

#### accessories

#### pilot burner brackets

#### universal

|  |   |        |                 |      |
|--|---|--------|-----------------|------|
|  | <b>Part No.</b>   | 100894 | <b>Ref. No.</b> | 3705 |
|  | opposite support for pilot burner suitable for 100 series |        |                 |      |
|  | <b>For models:</b> H1BP, S3SB, S4SH                       |        |                 |      |





1

|                    |  |                 |      |
|--------------------|--|-----------------|------|
| <b>Part No.</b>    | 100893   | <b>Ref. No.</b> | 3786 |
| <b>description</b> | pilot burner bracket suitable for 100 series 2-piece |                 |      |
| <b>For models:</b> | H1BP, S3SB, S4SH                                     |                 |      |



1

|                    |                             |                 |      |
|--------------------|-----------------------------|-----------------|------|
| <b>Part No.</b>    | 100888                      | <b>Ref. No.</b> | 3704 |
| <b>description</b> | screw bolt for pilot burner |                 |      |
| <b>For models:</b> | H1BP, S3SB                  |                 |      |

## miscellaneous



1

|                    |  |                 |          |
|--------------------|--|-----------------|----------|
| <b>Part No.</b>    | 100885   | <b>Ref. No.</b> | C5815189 |
| <b>description</b> | air mixing sleeve for pilot burner Qty 1 pcs                           |                 |          |
| <b>For models:</b> | C8L, H1PH, H4H, H6H, HGR, HGR2, R2T, R4H, R6L, S2, S2P, S2SH, S4, S4SH |                 |          |

## POLIDORO

## pilot burners



1

|                    |  |                 |          |
|--------------------|--|-----------------|----------|
| <b>Part No.</b>    | 106837   | <b>Ref. No.</b> | C5810129 |
| <b>description</b> | pilot burner POLIDORO 3 flames natural gas code 27.2   |                 |          |
| <b>For models:</b> | C8L, H1B, H1FV, H1L, H2B, H4H, H6H, HBG, HCP, HF20, HF40, HM100, HM150, HMI100, HMI150, HSB120, HSB80, R1T, R1TC, R4H, R6L, RBG, RBP, RCP, RM70, SBG, SBP, SF10EG, SF20EG, SP12C, SP4C, SP8C |                 |          |

## producer-specific pilot burners

## EURAST





1

|   |   |                 |                                      |
|---|---|-----------------|--------------------------------------|
| <b>Part No.</b>   | 107485  | <b>Ref. No.</b> | C5815249M                            |
| <b>description</b>  | pilot burner LPG code 20  |                 |                                      |
| <b>For models:</b>  | H1PH, H4H, H6H, HGR, HGR2, R4H, S2, S2P, S2SH, S4, S4SH                           |                 |                                      |
| <b>spare parts for</b>  | 107485  |                 |                                      |
|    | <b>Part No.</b>   | 100245          | <b>Ref. No.</b> —                    |
|   | pilot burner nozzle LPG code 20 bore $\varnothing$ 0.2mm Qty 1 pcs thread M8x0.75 |                 |                                      |
|    | <b>Part No.</b>   | 100885          | <b>Ref. No.</b> C5815189             |
|   | air mixing sleeve for pilot burner Qty 1 pcs                                      |                 |                                      |
|    | <b>Part No.</b>   | 100904          | <b>Ref. No.</b> —                    |
|   | locking screw M10x1 for pipe $\varnothing$ 4mm Qty 1 pcs                          |                 |                                      |
|   | <b>Part No.</b>   | 100905          | <b>Ref. No.</b> C5815359             |
|   | locking screw M10x1 for pipe $\varnothing$ 6mm Qty 1 pcs                          |                 |                                      |
|  | <b>Part No.</b>   | 106844          | <b>Ref. No.</b> C5815249<br>C5815309 |
|   | pilot burner 1 flame  |                 |                                      |
|  | <b>Part No.</b>   | 106845          | <b>Ref. No.</b> C5815099             |
|   | pilot burner centre part $\varnothing$ 8mm  |                 |                                      |
|  | <b>Part No.</b>   | 107483          | <b>Ref. No.</b> C5815169             |
|   | pilot burner bottom part LPG code 20  |                 |                                      |
|  | <b>Part No.</b>   | 697942          | <b>Ref. No.</b> C5815279             |
|   | gasket for pilot burner $\varnothing$ 35.5mm thickness 1mm                        |                 |                                      |

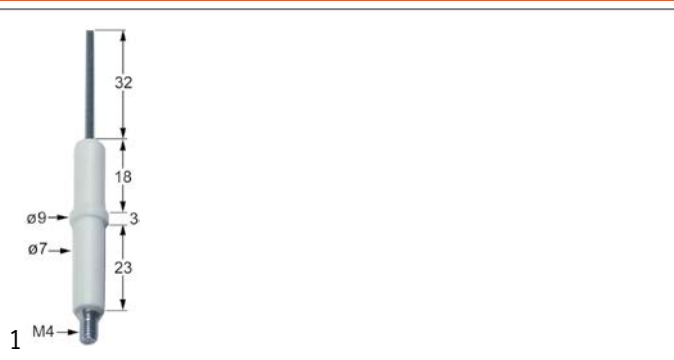

electrodes



|   |  |                 |                          |
|---|--|-----------------|--------------------------|
| <b>Part No.</b>   | 100701   | <b>Ref. No.</b> | C5810139                 |
| <b>description</b>  | ignition electrode connection M4 Qty 1 pcs   |                 |                          |
| <b>For models:</b>  | C8L, H1B, H1FV, H1L, H2B, H4H, H6H, HBG, HCP, HF20, HF40, HM100, HM150, HMI100, HMI150, HSB120, HSB80, R1T, R1TC, R4H, R6L, RBG, RBP, RCP, RM70, SBG, SBP, SF10EG, SF20EG, SP12C, SP4C, SP8C |                 |                          |
| <b>accessories for</b>  | 100701   |                 |                          |
|  | <b>Part No.</b>  | 100906          | <b>Ref. No.</b> A1018998 |
|   | screw connection thread M10x1 for ignition electrode brass Qty 1 pcs WS 10   |                 |                          |

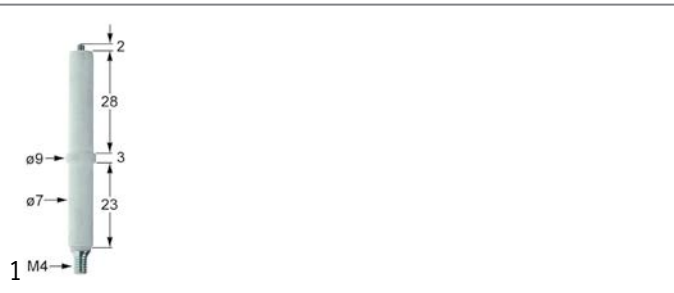

|                    |   |                 |          |
|--------------------|---|-----------------|----------|
| <b>Part No.</b>    | 102314  | <b>Ref. No.</b> | 96010061 |
| <b>description</b> | ignition electrode D1 ø 7mm D2 ø 9mm connection M4 L1 2mm BL1 28mm BL2 3mm BL3 23mm to clip |                 |          |
| <b>For models:</b> | HCP, RCP  |                 |          |

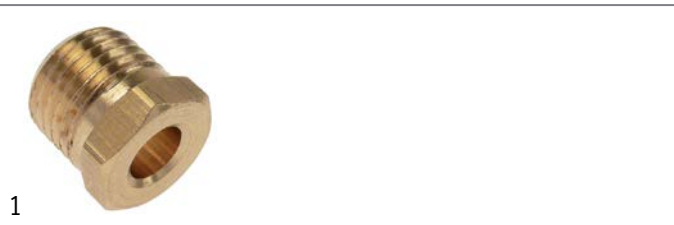

|                    |  |                 |          |
|--------------------|--|-----------------|----------|
| <b>Part No.</b>    | 100906   | <b>Ref. No.</b> | A1018998 |
| <b>description</b> | screw connection thread M10x1 for ignition electrode brass Qty 1 pcs WS 10   |                 |          |
| <b>For models:</b> | C8L, H1B, H1FV, H1L, H2B, H4H, H6H, HBG, HCP, HF20, HM100, HM150, HMI100, HMI150, HSB120, HSB80, R1T, R1TC, R4H, R6L, RBG, RBP, RCP, RM70, SBG, SBP, SF10EG, SF20EG, SP12C, SP4C, SP8C |                 |          |

ignition cables

pre-assembled cables



|                    |  |                 |      |
|--------------------|--|-----------------|------|
| <b>Part No.</b>    | 102164   | <b>Ref. No.</b> | 2175 |
| <b>description</b> | ignition cable cable length 1000mm connection F6.3mm / lug M4  |                 |      |
| <b>For models:</b> | C8L, H1B, H1BP, H1FV, H1L, H2B, H4H, H6H, HBG, HCP, HF40, HM100, HM150, HMI100, HMI150, R4H, R6L, RBG, RBP, RCP, RM70, S3SB, S4SH, SBG, SBP, SP12C, SP8C |                 |      |

|                    |  |                 |      |
|--------------------|--|-----------------|------|
| <b>Part No.</b>    | 102177   | <b>Ref. No.</b> | 2193 |
| <b>description</b> | ignition cable cable length 600mm connection F6.3mm / lug M4           |                 |      |
| <b>For models:</b> | H1FV, HBG, HSB120, HSB80, R1T, R1TC, SF10EG, SF20EG, SP12C, SP4C, SP8C |                 |      |

piezoelectric igniters

miscellaneous

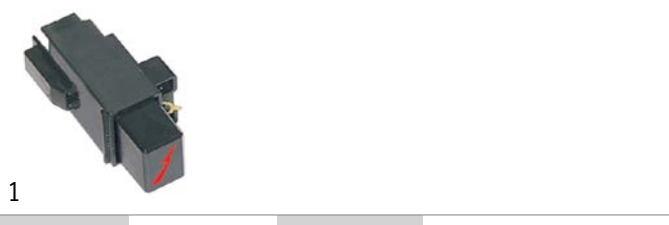

|                    |  |                 |      |
|--------------------|--|-----------------|------|
| <b>Part No.</b>    | nla <sup>1</sup>   | <b>Ref. No.</b> | 3747 |
| <b>description</b> | piezoelectric igniter suitable for Minisit connection F6.3x0.8 ømm   |                 |      |
| <b>For models:</b> | C8L, H1FV, H1L, H4H, H6H, HBG, HM150, HSB120, HSB80, R1TC, R4H, R6L, S3SB, SBG, SBP, SF20EG, SP12C, SP4C, SP8C |                 |      |

<sup>1</sup>no longer available

thermocouples



plug-in thermocouples

plug-in thermocouples standard

with barrel socket ø6(6.5)mm

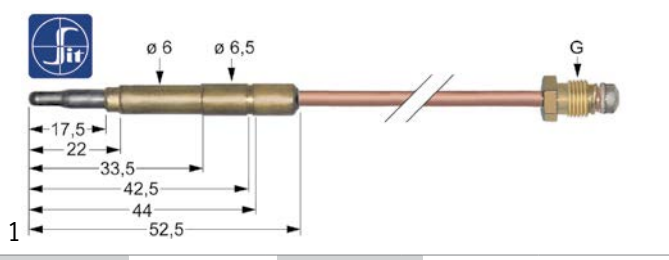
thermocouples SIT



|   |   |                 |                   |
|---|---|-----------------|-------------------|
| <b>Part No.</b>   | 107602  | <b>Ref. No.</b> | C5811809          |
| <b>description</b>  | thermocouple SIT M8x1 L 850mm plug connection ø6.0(6.5)mm |                 |                   |
| <b>For models:</b>  | H1BP, S3SB, S4SH  |                 |                   |
| <b>accessories for</b>  | 107602  |                 |                   |
|  | <b>Part No.</b>   | 100920          | <b>Ref. No.</b> — |
|   | thermocouple fitting thread M8x1 / M9x1 Qty 1 pcs         |                 |                   |
|  | <b>Part No.</b>   | 100922          | <b>Ref. No.</b> — |
|   | thermocouple fitting thread M10x1 / ASA 11/32 Qty 1 pcs   |                 |                   |



|                    |  |                 |          |
|--------------------|--|-----------------|----------|
| <b>Part No.</b>    | 107612   | <b>Ref. No.</b> | C5811009 |
| <b>description</b> | thermocouple SIT M9x1 L 1000mm plug connection ø6.0(6.5)mm |                 |          |
| <b>For models:</b> | H1FV   |                 |          |

|                    |   |                 |          |
|--------------------|---|-----------------|----------|
| <b>Part No.</b>    | 107611  | <b>Ref. No.</b> | C5811679 |
| <b>description</b> | thermocouple SIT M9x1 L 850mm plug connection ø6.0(6.5)mm |                 |          |
| <b>For models:</b> | H1B, H1L, H2B, H4H  |                 |          |

|                    |  |                 |          |
|--------------------|--|-----------------|----------|
| <b>Part No.</b>    | 107614   | <b>Ref. No.</b> | C5811059 |
| <b>description</b> | thermocouple SIT M9x1 L 1500mm plug connection ø6.0(6.5)mm |                 |          |
| <b>For models:</b> | HM100, HM150, HMI100, HMI150, R4H, RM70                    |                 |          |

|                    |  |                 |          |
|--------------------|--|-----------------|----------|
| <b>Part No.</b>    | 107606   | <b>Ref. No.</b> | C5820049 |
| <b>description</b> | thermocouple SIT M9x1 L 320mm plug connection ø6.0(6.5)mm  |                 |          |
| <b>For models:</b> | 105, 10P, 1260, 1680, 20P, 210, 30P, 315, 40P, 420, 5P, 630, 840, HBG, HSB120, HSB80, R1T, R1TC, SF10EG, SF20EG, SP12C, SP4C, SP8C |                 |          |

|                    |   |                 |          |
|--------------------|---|-----------------|----------|
| <b>Part No.</b>    | 107609  | <b>Ref. No.</b> | C5811829 |
| <b>description</b> | thermocouple SIT M9x1 L 600mm plug connection ø6.0(6.5)mm   |                 |          |
| <b>For models:</b> | C8L, H1BP, H1FV, H1L, H4H, H6H, HBG, HCP, HM150, R4H, R6L, RBG, RBP, RCP, S4SH, SBG, SBP, SF20EG, SP12C, SP8C |                 |          |

threaded thermocouples  
threaded thermocouples standard  
with socket with thread M8x1  
SIT

|   |  |                 |                          |
|---|--|-----------------|--------------------------|
| <b>Part No.</b>   | 107628   | <b>Ref. No.</b> | C5811019                 |
| <b>description</b>  | thermocouple SIT M8x1 L 320mm M8x1   |                 |                          |
| <b>For models:</b>  | FOK30, FOK60, FOK90, H4H, H6H, PC100, PC100C, PC100F, PC60, PC60C, PC60F, PC80, PC80C, PC80F, R4H, S2, S2P, S2SH, S3SB, S4, S4SH |                 |                          |
| <b>accessories for</b>  | 107628   |                 |                          |
|  | <b>Part No.</b>  | 102067          | <b>Ref. No.</b> C5811029 |
|   | nut thread M8x1 H 3mm brass Qty 1 pcs type SEF 1   |                 |                          |

|   |  |                 |                          |
|---|--|-----------------|--------------------------|
| <b>Part No.</b>   | 107629   | <b>Ref. No.</b> | C5811039                 |
| <b>description</b>  | thermocouple SIT M8x1 L 450mm M8x1   |                 |                          |
| <b>For models:</b>  | 105, 105E, 1155, 1260, 1260E, 1575, 1680, 1680E, 210, 210E, 315, 315E, 420, 420E, 630, 630E, 840, 840E |                 |                          |
| <b>accessories for</b>  | 107629   |                 |                          |
|  | <b>Part No.</b>  | 102067          | <b>Ref. No.</b> C5811029 |
|   | nut thread M8x1 H 3mm brass Qty 1 pcs type SEF 1   |                 |                          |

|                    |                                     |                 |          |
|--------------------|-------------------------------------|-----------------|----------|
| <b>Part No.</b>    | 107638                              | <b>Ref. No.</b> | C5811049 |
| <b>description</b> | thermocouple SIT M9x1 L 1000mm M8x1 |                 |          |
| <b>For models:</b> | C8L, H4H, R4H                       |                 |          |



|                        |  |                 |                          |
|------------------------|--|-----------------|--------------------------|
| <b>Part No.</b>        | 107635   | <b>Ref. No.</b> | C5811739                 |
| <b>description</b>     | thermocouple SIT M9x1 L 320mm M8x1               |                 |                          |
| <b>For models:</b>     | HGR  |                 |                          |
| <b>accessories for</b> | 107635   |                 |                          |
|                        | <b>Part No.</b>                                  | 102067          | <b>Ref. No.</b> C5811029 |
|                        | nut thread M8x1 H 3mm brass Qty 1 pcs type SEF 1 |                 |                          |

|                        |  |                 |                          |
|------------------------|--|-----------------|--------------------------|
| <b>Part No.</b>        | 107636   | <b>Ref. No.</b> | C5811849                 |
| <b>description</b>     | thermocouple SIT M9x1 L 600mm M8x1               |                 |                          |
| <b>For models:</b>     | HGR2   |                 |                          |
| <b>accessories for</b> | 107636   |                 |                          |
|                        | <b>Part No.</b>                                  | 102067          | <b>Ref. No.</b> C5811029 |
|                        | nut thread M8x1 H 3mm brass Qty 1 pcs type SEF 1 |                 |                          |

type Junkers with aluminised tip

|                        |  |                 |                          |
|------------------------|--|-----------------|--------------------------|
| <b>Part No.</b>        | 102233   | <b>Ref. No.</b> | C5811129                 |
| <b>description</b>     | thermocouple M8x1 L 750mm M8x1                   |                 |                          |
| <b>For models:</b>     | H4H, H6H   |                 |                          |
| <b>accessories for</b> | 102233   |                 |                          |
|                        | <b>Part No.</b>                                  | 102067          | <b>Ref. No.</b> C5811029 |
|                        | nut thread M8x1 H 3mm brass Qty 1 pcs type SEF 1 |                 |                          |

accessories

nuts

|                    |  |                 |          |
|--------------------|--|-----------------|----------|
| <b>Part No.</b>    | 102067   | <b>Ref. No.</b> | C5811029 |
| <b>description</b> | nut thread M8x1 H 3mm brass Qty 1 pcs type SEF 1   |                 |          |
| <b>For models:</b> | 105, 105E, 1155, 1260, 1260E, 1575, 1680, 1680E, 210, 210E, 315, 315E, 420, 420E, 630, 630E, 636P, 840, 840E, 848P, FOK30, FOK60, FOK90, PC100, PC100C, PC100F, PC60, PC60C, PC60F, PC80, PC80C, PC80F, S3SB |                 |          |

## gas burners

### hob burners

#### universal hob burners

##### ARC

##### 65 series

|                    |  |                 |          |
|--------------------|--|-----------------|----------|
| <b>Part No.</b>    | 104328   | <b>Ref. No.</b> | C5815139 |
| <b>description</b> | burner pipe 4.5kW L 93mm total length 108mm air mixer ø 18.2mm ED ø 32.9mm ID ø 22.7mm |                 |          |
| <b>For models:</b> | C8L, H4H, H6H, R2T, R4H, R6L, S2, S2P, S2SH, S4, S4SH                                  |                 |          |





##### SABAF

##### 1 series

|                        |   |                 |                          |
|------------------------|---|-----------------|--------------------------|
| <b>Part No.</b>        | 104288  | <b>Ref. No.</b> | C5815589                 |
| <b>description</b>     | burner cap 3.6kW ø 120mm                            |                 |                          |
| <b>For models:</b>     | FOK30, FOK60, FOK90                                 |                 |                          |
| <b>accessories for</b> | 104288  |                 |                          |
|                        | <b>Part No.</b>                                     | 104289          | <b>Ref. No.</b> C5815609 |
|                        | burner lower part 3/3.6kW for burner cap ø 90/120mm |                 |                          |
|                        | <b>Part No.</b>                                     | 105086          | <b>Ref. No.</b> C5815579 |
|                        | burner ring 3.6kW for burner cap ø 120mm            |                 |                          |
|                        | <b>Part No.</b>                                     | 105087          | <b>Ref. No.</b> C5815599 |
|                        | burner head 3.6kW for burner cap ø 120mm            |                 |                          |

|                        |  |                 |                          |
|------------------------|--|-----------------|--------------------------|
| <b>Part No.</b>        | 105087                                   | <b>Ref. No.</b> | C5815599                 |
| <b>description</b>     | burner head 3.6kW for burner cap ø 120mm |                 |                          |
| <b>For models:</b>     | FOK30, FOK60, FOK90                      |                 |                          |
| <b>accessories for</b> | 105087                                   |                 |                          |
|                        | <b>Part No.</b>                          | 104288          | <b>Ref. No.</b> C5815589 |
|                        | burner cap 3.6kW ø 120mm                 |                 |                          |
|                        | <b>Part No.</b>                          | 105085          | <b>Ref. No.</b> —        |
|                        | burner cap ø 120mm                       |                 |                          |
|                        | <b>Part No.</b>                          | 105086          | <b>Ref. No.</b> C5815579 |
|                        | burner ring 3.6kW for burner cap ø 120mm |                 |                          |
|                        | <b>Part No.</b>                          | 105088          | <b>Ref. No.</b> —        |
|                        | burner cap A ø 110mm with central hole   |                 |                          |
|                        | <b>Part No.</b>                          | 105089          | <b>Ref. No.</b> —        |
|                        | burner ring 3kW for burner cap ø 90mm    |                 |                          |



|   |   |                 |                          |
|---|---|-----------------|--------------------------|
|    |   |                 |                          |
| 1   |   |                 |                          |
| <b>Part No.</b>   | 104289  | <b>Ref. No.</b> | C5815609                 |
| <b>description</b>  | burner lower part 3/3.6kW for burner cap ø 90/120mm |                 |                          |
| <b>For models:</b>  | FOK30, FOK60, FOK90                                 |                 |                          |
| <b>accessories for</b>  | 104289  |                 |                          |
|    | <b>Part No.</b>                                     | 104286          | <b>Ref. No.</b> —        |
|   | burner cap 3kW ø 90mm                               |                 |                          |
|    | <b>Part No.</b>                                     | 104288          | <b>Ref. No.</b> C5815589 |
|   | burner cap 3.6kW ø 120mm                            |                 |                          |
|    | <b>Part No.</b>                                     | 105086          | <b>Ref. No.</b> C5815579 |
|   | burner ring 3.6kW for burner cap ø 120mm            |                 |                          |
|    | <b>Part No.</b>                                     | 105087          | <b>Ref. No.</b> C5815599 |
|   | burner head 3.6kW for burner cap ø 120mm            |                 |                          |
|    | <b>Part No.</b>                                     | 105089          | <b>Ref. No.</b> —        |
|   | burner ring 3kW for burner cap ø 90mm               |                 |                          |
|    | <b>Part No.</b>                                     | 105090          | <b>Ref. No.</b> —        |
|   | burner head 3kW for burner cap ø 90mm               |                 |                          |
|  | <b>Part No.</b>                                     | 106482          | <b>Ref. No.</b> —        |
|   | gas injector thread M6x0.75 WS 7 bore ø 1.1mm       |                 |                          |
|  | <b>Part No.</b>                                     | 106485          | <b>Ref. No.</b> —        |
|   | gas injector thread M6x0.75 WS 7 bore ø 1.6mm       |                 |                          |

|   |  |                 |                          |
|---|--|-----------------|--------------------------|
|  |  |                 |                          |
| 1   |  |                 |                          |
| <b>Part No.</b>   | 105086                                   | <b>Ref. No.</b> | C5815579                 |
| <b>description</b>  | burner ring 3.6kW for burner cap ø 120mm |                 |                          |
| <b>For models:</b>  | FOK30, FOK60, FOK90                      |                 |                          |
| <b>accessories for</b>  | 105086                                   |                 |                          |
|  | <b>Part No.</b>                          | 105085          | <b>Ref. No.</b> —        |
|   | burner cap ø 120mm                       |                 |                          |
|  | <b>Part No.</b>                          | 105087          | <b>Ref. No.</b> C5815599 |
|   | burner head 3.6kW for burner cap ø 120mm |                 |                          |
|  | <b>Part No.</b>                          | 105088          | <b>Ref. No.</b> —        |
|   | burner cap A ø 110mm with central hole   |                 |                          |
|  | <b>Part No.</b>                          | 105089          | <b>Ref. No.</b> —        |
|   | burner ring 3kW for burner cap ø 90mm    |                 |                          |

tube burners

|  |   |                 |          |
|--|---|-----------------|----------|
|  |   |                 |          |
| 1  |   |                 |          |
| <b>Part No.</b>  | 104414  | <b>Ref. No.</b> | C5815399 |
| <b>description</b>   | tubular burner ø 74mm L 180mm thread 3/8" H 52mm ID ø 25mm W 74mm |                 |          |
| <b>For models:</b>   | SF10EG, SF20EG  |                 |          |

ceramic burners

|  |  |                 |                    |
|--|--|-----------------|--------------------|
|  |  |                 |                    |
| 1  |  |                 |                    |
| <b>Part No.</b>  | 101938   | <b>Ref. No.</b> | 530587M<br>534030P |
| <b>description</b>   | ceramic burner L 845mm W 86mm firing range 61x801mm chicken rotisserie                                 |                 |                    |
| <b>For models:</b>   | 105, 105E, 1155, 1260, 1260E, 1575, 1680, 1680E, 210, 210E, 315, 315E, 420, 420E, 630, 630E, 840, 840E |                 |                    |

gas nozzles

main nozzles

gas nozzles M10x1

|  |  |                 |          |
|--|--|-----------------|----------|
|  |  |                 |          |
| 1  |  |                 |          |
| <b>Part No.</b>  | 107827   | <b>Ref. No.</b> | C5812660 |
| <b>description</b>   | gas injector thread M10x1 WS 12 bore ø 1.45mm GN |                 |          |
| <b>For models:</b>   | H1FV, H1PH, HGR, HGR2                            |                 |          |

|  |   |                 |          |
|--|---|-----------------|----------|
|  |   |                 |          |
| 1  |   |                 |          |
| <b>Part No.</b>  | 107828  | <b>Ref. No.</b> | C5812680 |
| <b>description</b>   | gas injector thread M10x1 WS 12 bore ø 1.9mm GLP                  |                 |          |
| <b>For models:</b>   | 1155, 1575, 315, 420, 630, 636P, 840, 848P, H1FV, H1PH, HGR, HGR2 |                 |          |





|  |  |                 |          |
|--|--|-----------------|----------|
|  <p>1</p> |  |                 |          |
| <b>Part No.</b>  | 107826   | <b>Ref. No.</b> | C5812640 |
| <b>description</b>   | gas injector thread M10x1 WS 12 bore ø 1mm GLP |                 |          |
| <b>For models:</b>   | H1FV, H1PH, HGR, HGR2                          |                 |          |

|  |   |                 |          |
|--|---|-----------------|----------|
|  <p>1</p> |   |                 |          |
| <b>Part No.</b>  | 107829  | <b>Ref. No.</b> | C5812689 |
| <b>description</b>   | gas injector thread M10x1 WS 12 bore ø 2.2mm GN |                 |          |
| <b>For models:</b>   | H1PH, HGR2                                      |                 |          |

pilot burner nozzles

pilot burner nozzles POLIDORO



|  |  |                 |          |
|--|--|-----------------|----------|
|  <p>1</p> |  |                 |          |
| <b>Part No.</b>  | 100000   | <b>Ref. No.</b> | C5810169 |
| <b>description</b>   | pilot burner nozzle POLIDORO LPG code 22 bore ø 0.22mm Qty 1 pcs   |                 |          |
| <b>For models:</b>   | C8L, H1B, H1FV, H1L, H2B, H4H, H6H, HBG, HCP, HF20, HF40, HM100, HM150, HMI100, HMI150, HSB120, HSB80, R1T, R1TC, R4H, R6L, RBG, RBP, RCP, RM70, SBG, SBP, SF10EG, SF20EG, SP12C, SP4C, SP8C |                 |          |



|  |  |                 |          |
|--|--|-----------------|----------|
|  <p>1</p> |  |                 |          |
| <b>Part No.</b>  | 106703   | <b>Ref. No.</b> | C5810159 |
| <b>description</b>   | pilot burner nozzle POLIDORO natural gas code 27.2 bore ø 2x0.27mm Qty 1 pcs   |                 |          |
| <b>For models:</b>   | C8L, H1B, H1FV, H1L, H2B, H4H, H6H, HBG, HCP, HF20, HF40, HM100, HM150, HMI100, HMI150, HSB120, HSB80, R1T, R1TC, R4H, R6L, RBG, RBP, RCP, RM70, SBG, SBP, SF10EG, SF20EG, SP12C, SP4C, SP8C |                 |          |

auxiliary gas parts

screw connections



olives



|  |  |                 |        |
|--|--|-----------------|--------|
|  <p>1</p> |  |                 |        |
| <b>Part No.</b>  | 101278   | <b>Ref. No.</b> | 3781   |
| <b>description</b>   | olive for pipe ø 10mm Qty 1 pcs  |                 |        |
| <b>For models:</b>   | C8L, H1B, H1FV, H1L, H1PH, H2B, H4H, H6H, HBG, HCP, HF20, HF40, HGR, HGR2, HM100, HM150, HMI100, HMI150, HSB120, HSB80, PC100, PC100C, PC100F, PC80, PC80C, PC80F, R1T, R1TC, R2T, R4H, R6L, RBG, RBP, RCP, RM70, S2, S2P, S2SH, S4, S4SH, SBG, SBP, SF10EG, SF20EG, SP12C, SP4C, SP8C |                 |        |
| <b>accessories for</b>   | 101278   |                 |        |
|  |   | Part No.        | 100943 |
|  |  | Ref. No.        | —      |
|  | union nut thread M17x1 tube ø 10mm   |                 |        |

|                        |   |          |        |
|------------------------|---|----------|--------|
| <b>accessories for</b> | 101278  |          |        |
|                        |  | Part No. | 101300 |
|                        |   | Ref. No. | 3782   |
|                        | union nut thread M16x1.5 tube ø 10mm  |          |        |
|                        |  | Part No. | 101478 |
|                        |   | Ref. No. | —      |
|                        | union nut thread 3/8" for pipe ø 10mm   |          |        |

|  |  |                 |          |
|--|--|-----------------|----------|
|  <p>1</p> |  |                 |          |
| <b>Part No.</b>  | 102797   | <b>Ref. No.</b> | A1018999 |
| <b>description</b>   | olive for pipe ø 6mm Qty 1 pcs   |                 |          |
| <b>For models:</b>   | C8L, H1B, H1FV, H1L, H2B, H4H, H6H, HBG, HCP, HF20, HF40, HM100, HM150, HMI100, HMI150, HSB120, HSB80, R1T, R1TC, R4H, R6L, RBG, RBP, RCP, RM70, SBG, SBP, SF10EG, SF20EG, SP12C, SP4C, SP8C |                 |          |

union nuts

|  |   |                 |          |
|--|---|-----------------|----------|
|  <p>1</p> |   |                 |          |
| <b>Part No.</b>  | 101296  | <b>Ref. No.</b> | C5815539 |
| <b>description</b>   | union nut thread M12x1 for pipe ø 8mm   |                 |          |
| <b>For models:</b>   | S3SB  |                 |          |
| <b>accessories for</b>   | 101296  |                 |          |
|  |  | Part No.        | 101277   |
|  |   | Ref. No.        | C5815549 |
|  | olive ID ø 8mm Qty 1 pcs  |                 |          |

|  |  |                 |        |
|--|--|-----------------|--------|
|  <p>1</p> |  |                 |        |
| <b>Part No.</b>  | 101300   | <b>Ref. No.</b> | 3782   |
| <b>description</b>   | union nut thread M16x1.5 tube ø 10mm   |                 |        |
| <b>For models:</b>   | C8L, H1B, H1FV, H1L, H1PH, H2B, H4H, H6H, HBG, HCP, HF20, HF40, HGR, HGR2, HM100, HM150, HMI100, HMI150, HSB120, HSB80, PC100, PC100C, PC100F, PC80, PC80C, PC80F, R1T, R1TC, R2T, R4H, R6L, RBG, RBP, RCP, RM70, S2, S2P, S2SH, S4, S4SH, SBG, SBP, SF10EG, SF20EG, SP12C, SP4C, SP8C |                 |        |
| <b>accessories for</b>   | 101300   |                 |        |
|  |   | Part No.        | 101278 |
|  |  | Ref. No.        | 3781   |
|  | olive for pipe ø 10mm Qty 1 pcs  |                 |        |



union screws

|   |  |                 |          |
|---|--|-----------------|----------|
|  |  |                 |          |
| 1   |  |                 |          |
| <b>Part No.</b>   | 100905   | <b>Ref. No.</b> | C5815359 |
| <b>description</b>  | locking screw M10x1 for pipe ø 6mm Qty 1 pcs   |                 |          |
| <b>For models:</b>  | H1B, H1FV, H1L, H1PH, H2B, H4H, H6H, HBG, HCP, HF20, HF40, HGR, HGR2, HM100, HM150, HMI100, HMI150, HSB120, HSB80, R1T, R1TC, R2T, R4H, R6L, RBG, RBP, RCP, RM70, S2, S2P, S2SH, S4, S4SH, SBG, SBP, SF10EG, SF20EG, SP12C, SP4C, SP8C |                 |          |

|   |  |                 |          |
|---|--|-----------------|----------|
|  |  |                 |          |
| 1   |  |                 |          |
| <b>Part No.</b>   | 100906   | <b>Ref. No.</b> | A1018998 |
| <b>description</b>  | screw connection thread M10x1 for ignition electrode brass Qty 1 pcs WS 10   |                 |          |
| <b>For models:</b>  | C8L, H1B, H1FV, H1L, H2B, H4H, H6H, HBG, HCP, HF20, HM100, HM150, HMI100, HMI150, HSB120, HSB80, R1T, R1TC, R4H, R6L, RBG, RBP, RCP, RM70, SBG, SBP, SF10EG, SF20EG, SP12C, SP4C, SP8C |                 |          |

|  |  |                 |          |
|--|--|-----------------|----------|
|  |  |                 |          |
| 1  |  |                 |          |
| <b>Part No.</b>  | 100907   | <b>Ref. No.</b> | A1018996 |
| <b>description</b>   | screw connection thread M10x1 Qty 1 pcs type SEF 1 ømm for thermocouple  |                 |          |
| <b>For models:</b>   | C8L, H1B, H1FV, H1L, H2B, H4H, H6H, HBG, HCP, HF20, HF40, HM100, HM150, HMI100, HMI150, HSB120, HSB80, R1T, R1TC, R4H, R6L, RBG, RBP, RCP, RM70, SBG, SBP, SF10EG, SF20EG, SP12C, SP4C, SP8C |                 |          |



|   |  |                 |                   |
|---|--|-----------------|-------------------|
|  |  |                 |                   |
| 1   |  |                 |                   |
| <b>Part No.</b>   | 100909   | <b>Ref. No.</b> | A1018997          |
| <b>description</b>  | union screw thread M10x1 for pipe ø 6mm Qty 1 pcs  |                 |                   |
| <b>For models:</b>  | C8L, H1B, H1FV, H1L, H2B, H4H, H6H, HBG, HCP, HF20, HF40, HM100, HM150, HMI100, HMI150, HSB120, HSB80, R1T, R1TC, R4H, R6L, RBG, RBP, RCP, RM70, SBG, SBP, SF10EG, SF20EG, SP12C, SP4C, SP8C |                 |                   |
| <b>accessories for</b>  | 100909   |                 |                   |
|  | <b>Part No.</b>  | 100898          | <b>Ref. No.</b> — |
| olive for pipe ø 6mm Qty 1 pcs for pilot burner                                     |  |                 |                   |
|  | <b>Part No.</b>  | 101286          | <b>Ref. No.</b> — |
| olive ID ø 6mm Qty 1 pcs  |  |                 |                   |
|  | <b>Part No.</b>  | 101287          | <b>Ref. No.</b> — |
| olive for pipe ø 6mm Qty 1 pcs  |  |                 |                   |
|  | <b>Part No.</b>  | 101288          | <b>Ref. No.</b> — |
| olive for pipe ø 6mm L 6mm aluminium Qty 1 pcs ED ø 8.5mm                           |  |                 |                   |

equipment-specific units

for chicken rotisserie

|  |  |                 |          |
|--|--|-----------------|----------|
|  |  |                 |          |
| skewers  |  |                 |          |
| 1  |  |                 |          |
| <b>Part No.</b>  | 689000   | <b>Ref. No.</b> | 70290029 |
| <b>description</b>   | skewer square L 835mm thickness 12mm   |                 |          |
| <b>For models:</b>   | 105, 105E, 1155, 1260, 1260E, 1575, 1680, 1680E, 210, 210E, 315, 315E, 420, 420E, 630, 630E, 840, 840E |                 |          |

|   |  |                 |            |
|---|--|-----------------|------------|
|  |  |                 |            |
| spit clamp  |  |                 |            |
| 1   |  |                 |            |
| <b>Part No.</b>   | 693143   | <b>Ref. No.</b> | 702.4D.001 |
| <b>description</b>  | skewer clamp crimping range 13x13mm <sup>2</sup> double for skewer 12x12mm mounting pos. inner skewer 2x60mm skewer ø 4mm  |                 |            |
| <b>For models:</b>  | 105, 105E, 10P, 1155, 1260, 1260E, 1575, 1680, 1680E, 20P, 210, 210E, 30P, 315, 315E, 40P, 420, 420E, 630, 630E, 840, 840E |                 |            |

|   |  |                 |                   |
|---|--|-----------------|-------------------|
|   |  |                 |                   |
| 1   |  |                 |                   |
| <b>Part No.</b>   | 693142   | <b>Ref. No.</b> | 702.4S.001        |
| <b>description</b>  | skewer clamp single for skewer 12x12mm mounting pos. outer skewer 75mm skewer ø 4mm                    |                 |                   |
| <b>For models:</b>  | 105, 105E, 1155, 1260, 1260E, 1575, 1680, 1680E, 210, 210E, 315, 315E, 420, 420E, 630, 630E, 840, 840E |                 |                   |
| <b>accessories for</b>  | 693142   |                 |                   |
|  | <b>Part No.</b>  | 697481          | <b>Ref. No.</b> — |
| Thumb screw thread M6 thread L 8mm ø 14mm H 6mm SS                                  |  |                 |                   |

knobs

producer-specific knobs

|   |  |                 |                 |
|---|--|-----------------|-----------------|
|  |  |                 |                 |
| EURAST  |  |                 |                 |
| 1   |  |                 |                 |
| <b>Part No.</b>   | 111414   | <b>Ref. No.</b> | 348273PM<br>N/A |
| <b>description</b>  | knob zero mark ø 71.5mm shaft ø 6x4.6mm shaft flat upper red/black                                     |                 |                 |
| <b>For models:</b>  | 105, 105E, 1155, 1260, 1260E, 1575, 1680, 1680E, 210, 210E, 315, 315E, 420, 420E, 630, 630E, 840, 840E |                 |                 |



|  |  |                 |                 |
|--|--|-----------------|-----------------|
|  <p>1</p> |  |                 |                 |
| <b>Part No.</b>  | 111415   | <b>Ref. No.</b> | 340273PM<br>N/A |
| <b>description</b>   | knob zero mark ø 71.5mm shaft ø 8x6.5mm shaft flat upper red/black                                     |                 |                 |
| <b>For models:</b>   | 105, 105E, 1155, 1260, 1260E, 1575, 1680, 1680E, 210, 210E, 315, 315E, 420, 420E, 630, 630E, 840, 840E |                 |                 |

## handles and hand wheels

### hand wheels

#### hand wheels

|   |  |                 |          |
|---|--|-----------------|----------|
|  <p>1</p> |  |                 |          |
| <b>Part No.</b>   | 694357   | <b>Ref. No.</b> | C6262619 |
| <b>description</b>  | hand wheel ø 200mm D1 ø 50mm bore ø 15mm hole ø 7.2mm thread groove widthmm L1 46mm L2 50mm handle length 90mm with folding handle |                 |          |
| <b>For models:</b>  | HSB120, HSB80  |                 |          |

### bracket handles



|  |   |                 |          |
|--|---|-----------------|----------|
|  <p>1</p> |   |                 |          |
| <b>Part No.</b>  | 697944  | <b>Ref. No.</b> | 70491019 |
| <b>description</b>   | handle L 150mm H 38mm mounting distance 135mm thread M6 W 30mm black matt   |                 |          |
| <b>For models:</b>   | 105, 105E, 1155, 1260, 1260E, 1575, 1680, 1680E, 210, 210E, 315, 315E, 420, 420E, 630, 630E, 636P, 840, 840E, 848P, A4E |                 |          |

## hinges



### spring assisted hinges

#### producer-specific

#### CORECO

|   |   |                 |   |
|---|---|-----------------|---|
|  <p>1</p> |   |                 |   |
| <b>Part No.</b>   | 700830  | <b>Ref. No.</b> | C6262001  |
| <b>description</b>  | spring assisted hinge right/left L 75mm W 26mm H 102mm refrigeration units mounting distance 25mm |                 |   |
| <b>For models:</b>  | AC10G, AF02, AF04, AF04G, AF12, AM20G   |                 |   |
| <b>accessories for</b>  | 700830  |                 |   |
|   | <b>Part No.</b>   | <b>Ref. No.</b> | —   |
|            | 700854  |                 | hinge camp type TRB/L1 36mm mounting pos. bottom right L 100mm W 48mm H 17mm zinc die cast, chrome-plated hole distance 6.5x51x28mm shaft diameter torx 12x12mmmm |

#### FAGOR

|  |   |                 |   |
|--|---|-----------------|---|
|  <p>1</p> |   |                 |   |
| <b>Part No.</b>  | 700830  | <b>Ref. No.</b> | C6262001  |
| <b>description</b>   | spring assisted hinge right/left L 75mm W 26mm H 102mm refrigeration units mounting distance 25mm |                 |   |
| <b>For models:</b>   | AC10G, AF02, AF04, AF04G, AF12, AM20G   |                 |   |
| <b>accessories for</b>   | 700830  |                 |   |
|  | <b>Part No.</b>   | <b>Ref. No.</b> | —   |
|           | 700854  |                 | hinge camp type TRB/L1 36mm mounting pos. bottom right L 100mm W 48mm H 17mm zinc die cast, chrome-plated hole distance 6.5x51x28mm shaft diameter torx 12x12mmmm |





## oven hinges

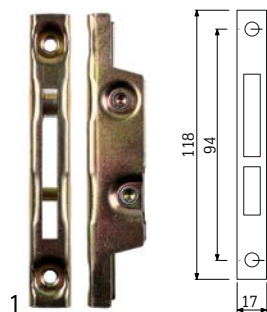

|                    |  |                 |       |
|--------------------|--|-----------------|-------|
| <b>Part No.</b>    | 700001   | <b>Ref. No.</b> | 61980 |
| <b>description</b> | opposite support L 118mm W 17mm mounting distance 94mm   |                 |       |
| <b>For models:</b> | C8L, H1B, H1BE, H1BP, H1BPE, H1FV, H1L, H2B, H2BE, H4H, H4HE, H6H, H8HE, R4H, R6L, S3SB, S4SH, S4SHE |                 |       |



|                    |   |                 |                  |
|--------------------|---|-----------------|------------------|
| <b>Part No.</b>    | 694359  | <b>Ref. No.</b> | 6160<br>C6262599 |
| <b>description</b> | oven hinge mounting distance 105mm lever length 129.5mm spring thickness 4mm mounting ear position right L 206mm W 25mm Qty 1 pcs |                 |                  |
| <b>For models:</b> | C8L, H1B, H1BE, H1BP, H1BPE, H1FV, H1L, H2B, H2BE, H4H, H4HE, H6H, H8HE, R4H, R6L, S4SH, S4SHE                                    |                 |                  |



|                    |   |                 |                  |
|--------------------|---|-----------------|------------------|
| <b>Part No.</b>    | 694360  | <b>Ref. No.</b> | 6163<br>C6262609 |
| <b>description</b> | oven hinge mounting distance 173mm mounting distance 2 105mm lug mounting 14mm lever length 119mm groove distance 11mm spring thickness 4mm mounting ear position left spring length 111mm L 206mm W 25mm |                 |                  |
| <b>For models:</b> | C8L, H1B, H1BE, H1BP, H1BPE, H1FV, H1L, H2B, H2BE, H4H, H4HE, H6H, H8HE, R4H, R6L, S4SH, S4SHE  |                 |                  |

## door bearing



|                    |  |                 |          |
|--------------------|--|-----------------|----------|
| <b>Part No.</b>    | 694358   | <b>Ref. No.</b> | C6262002 |
| <b>description</b> | bolt L 25mm W 25mm H 19mm ID $\varnothing$ 7mm for hinge |                 |          |
| <b>For models:</b> | AC10G, AF02, AF04, AF04G, AF12                           |                 |          |



|                    |  |                 |         |
|--------------------|--|-----------------|---------|
| <b>Part No.</b>    | 694361   | <b>Ref. No.</b> | 706203P |
| <b>description</b> | hinge L 100mm W 48mm mounting pos. centre left/right |                 |         |
| <b>For models:</b> | AC10G, AF02, AF04, AF04G, AF12                       |                 |         |



|                    |  |                 |         |
|--------------------|--|-----------------|---------|
| <b>Part No.</b>    | 694034   | <b>Ref. No.</b> | 705003P |
| <b>description</b> | hinge right/left mounting pos. lower for fridge L 130mm W 80mm |                 |         |
| <b>For models:</b> | AC10G, AF02, AF04, AF04G, AF12, AM20G                          |                 |         |



|                    |  |                 |         |
|--------------------|--|-----------------|---------|
| <b>Part No.</b>    | 694033   | <b>Ref. No.</b> | 706003P |
| <b>description</b> | hinge right/left mounting pos. upper for fridge L 130mm W 80mm |                 |         |
| <b>For models:</b> | AC10G, AF02, AF04, AF04G, AF12, AM20G                          |                 |         |

## fittings for catering equipment

## lid hinges

type RUBINETTERIE DEL FRIULI

for square and rectangular lids

## spare parts



|                    |   |                 |          |
|--------------------|---|-----------------|----------|
| <b>Part No.</b>    | 540848  | <b>Ref. No.</b> | C6260349 |
| <b>description</b> | torsion spring $\varnothing$ 43mm wire gauge $\varnothing$ 5mm L1 25mm L2 90mm L3 25mm mounting pos. left |                 |          |
| <b>For models:</b> | HM100, HM150, HMI100, HMI150, HMI150E, HSB120, HSB80, RM70  |                 |          |

1

|                    |  |                 |          |
|--------------------|--|-----------------|----------|
| <b>Part No.</b>    | 540849   | <b>Ref. No.</b> | C6260339 |
| <b>description</b> | torsion spring $\varnothing$ 43mm wire gauge $\varnothing$ 5mm L1 25mm L2 90mm L3 25mm mounting pos. right |                 |          |
| <b>For models:</b> | HM100, HM150, HMI100, HMI150, HMI150E, HSB120, HSB80, RM70   |                 |          |

miscellaneous  
spare parts



1

|                    |   |                 |          |
|--------------------|---|-----------------|----------|
| <b>Part No.</b>    | 514418  | <b>Ref. No.</b> | C6260239 |
| <b>description</b> | adjusting bush ID $\varnothing$ 47mm ED $\varnothing$ 50mm L 63.5mm |                 |          |
| <b>For models:</b> | HM100, HM150, HMI100, HMI150, HMI150E, HSB120, HSB80, RM70          |                 |          |



1

|                    |  |                 |         |
|--------------------|--|-----------------|---------|
| <b>Part No.</b>    | 514194   | <b>Ref. No.</b> | 481240P |
| <b>description</b> | bracket for lid hinge ID $\varnothing$ 50mm H 89mm |                 |         |
| <b>For models:</b> | HSB120, HSB80                                      |                 |         |



1

|                    |   |                 |         |
|--------------------|---|-----------------|---------|
| <b>Part No.</b>    | 514193  | <b>Ref. No.</b> | 480340P |
| <b>description</b> | bracket for lid hinge ID $\varnothing$ 51mm H 185mm |                 |         |
| <b>For models:</b> | HM100, HM150, HMI100, HMI150, HMI150E, RM70         |                 |         |

**gaskets**

refrigeration gaskets

plug-in gaskets

profile 9798

We offer custom-made gaskets for this profile

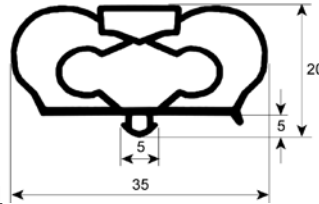

1

|                    |   |                 |         |
|--------------------|---|-----------------|---------|
| <b>Part No.</b>    | 901349  | <b>Ref. No.</b> | 705226P |
| <b>description</b> | refrigeration gasket profile 9798 W 602mm L 704mm plug size |                 |         |
| <b>For models:</b> | AC10G, AF02, AF04, AF04G, AF12                              |                 |         |

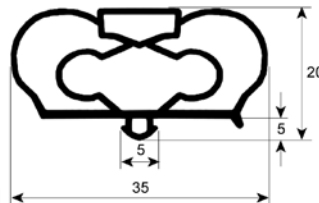

1

|                    |  |                 |         |
|--------------------|--|-----------------|---------|
| <b>Part No.</b>    | 901350   | <b>Ref. No.</b> | 746226P |
| <b>description</b> | refrigeration gasket profile 9798 W 604mm L 1492mm plug size |                 |         |
| <b>For models:</b> | AC10G, AF12, AM20G   |                 |         |

**gaskets for heated units**

door seals

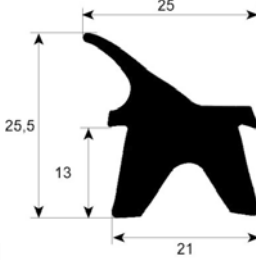

1

|                    |   |                 |         |
|--------------------|---|-----------------|---------|
| <b>Part No.</b>    | 901347  | <b>Ref. No.</b> | 490326P |
| <b>description</b> | door seal profile 2402 W 350mm L 575mm external size Qty 1                            |                 |         |
| <b>For models:</b> | H1B, H1BE, H1BP, H1BPE, H1FV, H2B, H2BE, H4H, H4HE, H6H, H8HE, R4H, S3SB, S4SH, S4SHE |                 |         |

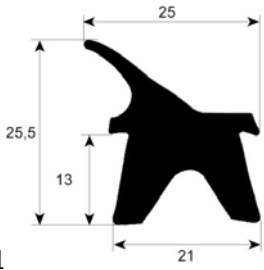
|                    |  |                 |         |
|--------------------|--|-----------------|---------|
| <b>Part No.</b>    | 901348   | <b>Ref. No.</b> | 499926P |
| <b>description</b> | door seal profile 2402 W 350mm L 985mm external size Qty 1 |                 |         |
| <b>For models:</b> | H1L, H6H, R6L  |                 |         |

## O-rings

## EPDM

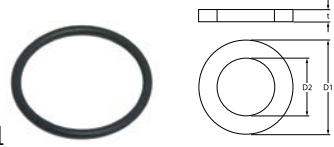

|                    |  |                 |      |
|--------------------|--|-----------------|------|
| <b>Part No.</b>    | 100809   | <b>Ref. No.</b> | 3785 |
| <b>description</b> | O-ring EPDM thickness 2mm ID $\varnothing$ 21mm Qty 1 pcs  |                 |      |
| <b>For models:</b> | H1B, H1FV, H1L, H2B, H4H, H6H, HF20, HF40, HSB120, HSB80, R1T, R1TC, R4H, R6L, SF10EG, SF20EG, SP12C, SP4C, SP8C |                 |      |

## springs

## torsion springs



|                    |   |                 |          |
|--------------------|---|-----------------|----------|
| <b>Part No.</b>    | 540848  | <b>Ref. No.</b> | C6260349 |
| <b>description</b> | torsion spring $\varnothing$ 43mm wire gauge $\varnothing$ 5mm L1 25mm L2 90mm L3 25mm mounting pos. left |                 |          |
| <b>For models:</b> | HM100, HM150, HMI100, HMI150, HMI150E, HSB120, HSB80, RM70  |                 |          |



|                    |  |                 |          |
|--------------------|--|-----------------|----------|
| <b>Part No.</b>    | 540849   | <b>Ref. No.</b> | C6260339 |
| <b>description</b> | torsion spring $\varnothing$ 43mm wire gauge $\varnothing$ 5mm L1 25mm L2 90mm L3 25mm mounting pos. right |                 |          |
| <b>For models:</b> | HM100, HM150, HMI100, HMI150, HMI150E, HSB120, HSB80, RM70   |                 |          |

## fastening material

## screws

## flat-headed bolts



|                    |  |                 |      |
|--------------------|--|-----------------|------|
| <b>Part No.</b>    | 101516   | <b>Ref. No.</b> | 1051 |
| <b>description</b> | flat-headed bolt thread M4 thread L 16mm SS DIN 7985/ISO 7045 Qty 1 pcs  |                 |      |
| <b>For models:</b> | H1B, H1FV, H1L, H2B, H4H, H6H, HF20, HF40, HSB120, HSB80, R1T, R1TC, R4H, R6L, SF10EG, SF20EG, SP12C, SP4C, SP8C |                 |      |

## nuts

## hexagonal nuts

## hexagonal nuts metric (without norm)



|                    |  |                 |          |
|--------------------|--|-----------------|----------|
| <b>Part No.</b>    | 102680   | <b>Ref. No.</b> | C5815299 |
| <b>description</b> | nut thread M6x0.75 H 2.6mm WS 8 brass Qty 1 pcs type SEF 2 |                 |          |
| <b>For models:</b> | C8L, H4H, H6H, R2T, R4H, R6L                               |                 |          |



|                    |  |                 |          |
|--------------------|--|-----------------|----------|
| <b>Part No.</b>    | 102067   | <b>Ref. No.</b> | C5811029 |
| <b>description</b> | nut thread M8x1 H 3mm brass Qty 1 pcs type SEF 1   |                 |          |
| <b>For models:</b> | 105, 105E, 1155, 1260, 1260E, 1575, 1680, 1680E, 210, 210E, 315, 315E, 420, 420E, 630, 630E, 636P, 840, 840E, 848P, FOK30, FOK60, FOK90, PC100, PC100C, PC100F, PC60, PC60C, PC60F, PC80, PC80C, PC80F, S3SB |                 |          |

**GASTRO**PARTS.COM

