



GASTROPARTS

Eloma

- [EN]** Equipment
- [DE]** Geräte
- [ES]** Aparatos
- [FR]** Équipement
- [IT]** Attrezzature
- [PL]** Urządzenia
- [RU]** Оборудование

✉ gastroparts@gastroparts.com

☎ +48 56 657 00 66

📘 fb.com/gastroparts.global

GASTROPARTS.COM







heating elements





heating elements for chicken rotisseries



1 			
Part No.	415532	Ref. No.	103691 E318012 ELO103691 ELE318012 R0210
description	heating element 1000W 230V L 700mm W 64mm Hmm heating circuits 1 connection male faston 6.3mm dry heating element tube ø 6.3mm connection distance 59mm		

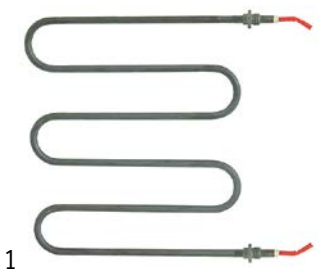





1 			
Part No.	415531	Ref. No.	530905 E318013 ELO530905 ELE318013 R0215
description	heating element 1000W 230V L 725mm W 50mm Hmm heating circuits 1 connection male faston 6.3mm dry heating element tube ø 6.3mm connection distance 46mm		

1 			
Part No.	415533	Ref. No.	532177 E318014 ELO532177 ELE318014 R0220
description	heating element 1100W 230V L 727mm W 50mm Hmm heating circuits 1 connection M4 dry heating element tube ø 8.6mm connection length 19mm		

heating elements for hot counters

1 			
Part No.	416510	Ref. No.	E318020 ELE318020 R0230
description	heating element 1200W 230V heating circuits 1 L 260mm W 284mm connection length 46mm tube ø 8.5mm cable length 480mm dry heating element hot bar 2 hole fixing thread M14x1.5 mounting distance 275mm		
spare parts for	416510		
	Part No.	550262	Ref. No. —
	flat gasket copper ED ø 20mm ID ø 14mm thickness 2mm		
accessories for	416510		
	Part No.	510417	Ref. No. —
	flat gasket fibre ED ø 20mm ID ø 14mm thickness 2mm Qty 1 pcs		
	Part No.	520228	Ref. No. —
	tooth lock washer ID ø 15.3mm ED ø 24mm steel Qty 1 pcs for thread M14		







accessories for	416510		
	Part No.	520230	Ref. No. —
	nut thread M14x1.5 H 5mm WS 19 zinc-coated steel Qty 1 pcs		
	Part No.	521101	Ref. No. —
	nut thread M14x1.5 H 5mm WS 19 SS Qty 1 pcs		

1 			
Part No.	416431	Ref. No.	E318042 ELE318042 R0299
description	heating element 1600W 230V heating circuits 1 L 212mm W 450mm connection length 38mm tube ø 8.5mm connection male faston 6.3mm dry heating element hot bar 2 hole fixing thread M14x1.5 mounting distance 442mm		
accessories for	416431		
	Part No.	510417	Ref. No. —
	flat gasket fibre ED ø 20mm ID ø 14mm thickness 2mm Qty 1 pcs		
	Part No.	520228	Ref. No. —
	tooth lock washer ID ø 15.3mm ED ø 24mm steel Qty 1 pcs for thread M14		
	Part No.	520230	Ref. No. —
	nut thread M14x1.5 H 5mm WS 19 zinc-coated steel Qty 1 pcs		
	Part No.	521101	Ref. No. —
	nut thread M14x1.5 H 5mm WS 19 SS Qty 1 pcs		
	Part No.	550262	Ref. No. —
	flat gasket copper ED ø 20mm ID ø 14mm thickness 2mm		

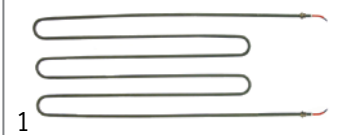



1 			
Part No.	416429	Ref. No.	E318044 ELE318044 R0303
description	heating element 1600W 230V heating circuits 1 L 300mm W 205mm W1 5mm W2 195mm tube ø 8.5mm connection male faston 6.3mm dry heating element hot bar L1 50mm L2 20mm L3 230mm 2 hole fixing thread M14x1.5 mounting distance 202mm		











			
Part No.	416430	Ref. No.	E318043 ELE318043 R0301
description	heating element 2000W 230V L 215mm W 415mm tube ø 8.5mm connection male faston 6.3mm dry heating element hot bar 2 hole fixing thread M14x1.5 mounting distance 409mm		

			
Part No.	416512	Ref. No.	E318022 ELE318022 R0240
description	heating element 2700W 230V heating circuits 1 L 822mm W 300mm connection length 55mm tube ø 8.6mm cable length 440mm dry heating element hot bar 2 hole fixing thread M14x1.5 mounting distance 291mm		
accessories for	416512		
	Part No.	510417	Ref. No. —
flat gasket fibre ED ø 20mm ID ø 14mm thickness 2mm Qty 1 pcs			
	Part No.	520228	Ref. No. —
tooth lock washer ID ø 15.3mm ED ø 24mm steel Qty 1 pcs for thread M14			
	Part No.	520230	Ref. No. —
nut thread M14x1.5 H 5mm WS 19 zinc-coated steel Qty 1 pcs			
	Part No.	521101	Ref. No. —
nut thread M14x1.5 H 5mm WS 19 SS Qty 1 pcs			
	Part No.	550262	Ref. No. —
flat gasket copper ED ø 20mm ID ø 14mm thickness 2mm			

heating elements for coffee machine

			
Part No.	415436	Ref. No.	E318036 ELE318036 R0285
description	heating element 1600W 220V L 240mm W 33mm H 30mm L1 65mm L2 175mm mounting distance 25mm thread M12x1 stainless steel connection M4 tube ø 8.5mm 2 hole fixing immersion heater		
accessories for	415436		
	Part No.	510413	Ref. No. —
flat gasket L 43mm W 19mm hole ø 12mm hole distance 24mm copper thickness 2.3mm for heating element			
	Part No.	510901	Ref. No. —
O-ring EPDM thickness 2mm ID ø 13mm Qty 1 pcs			
	Part No.	520229	Ref. No. —
nut thread M12x1 H 4mm WS 16 zinc-coated steel Qty 1 pcs			

accessories for	415436		
	Part No.	521103	Ref. No. —
nut thread M4 H 3mm WS 7 brass Qty 20 pcs			
	Part No.	521104	Ref. No. —
washer ID ø 4.3mm ED ø 8mm thickness 0.5mm brass Qty 20 pcs for thread M4			
	Part No.	521110	Ref. No. —
flat gasket fibre ED ø 20mm ID ø 13mm thickness 2mm Qty 1 pcs			
	Part No.	521131	Ref. No. —
nut thread M12x1 H 3.5mm WS 17 SS Qty 1 pcs			
	Part No.	560111	Ref. No. —
plain washer ID ø 4.3mm ED ø 9mm thickness 0.8mm SS Qty 20 pcs DIN 125A for thread M4			
	Part No.	560131	Ref. No. —
hexagonal nut thread M4 H 3.2mm WS 7 SS DIN/ISO DIN 934 / ISO 4032/8673 Qty 20 pcs			

			
Part No.	415439	Ref. No.	E318039 ELE318039 R0296
description	heating element 2000W 230V heating circuits 1 L 342mm W 33mm H 26mm mounting distance 25mm thread M12x1 connection M4 tube ø 8.5mm 2 hole fixing immersion heater		
spare parts for	415439		
	Part No.	532009	Ref. No. —
O-ring EPDM thickness 1.78mm ID ø 14mm Qty 10 pcs			
accessories for	415439		
	Part No.	520228	Ref. No. —
tooth lock washer ID ø 15.3mm ED ø 24mm steel Qty 1 pcs for thread M14			
	Part No.	520229	Ref. No. —
nut thread M12x1 H 4mm WS 16 zinc-coated steel Qty 1 pcs			
	Part No.	521103	Ref. No. —
nut thread M4 H 3mm WS 7 brass Qty 20 pcs			
	Part No.	521104	Ref. No. —
washer ID ø 4.3mm ED ø 8mm thickness 0.5mm brass Qty 20 pcs for thread M4			
	Part No.	560111	Ref. No. —
plain washer ID ø 4.3mm ED ø 9mm thickness 0.8mm SS Qty 20 pcs DIN 125A for thread M4			
	Part No.	560131	Ref. No. —
hexagonal nut thread M4 H 3.2mm WS 7 SS DIN/ISO DIN 934 / ISO 4032/8673 Qty 20 pcs			







			
1			
Part No.	415438	Ref. No.	E318038 ELE318038 R0295
description	heating element 4000W 220V L 430mm W 30mm H 37mm mounting distance 22mm thread M12x1 connection M4 tube ø 8.5mm 2 hole fixing immersion heater		
accessories for	415438		
	Part No.	510413	Ref. No. —
	flat gasket L 43mm W 19mm hole ø 12mm hole distance 24mm copper thickness 2.3mm for heating element		
	Part No.	520229	Ref. No. —
	nut thread M12x1 H 4mm WS 16 zinc-coated steel Qty 1 pcs		
	Part No.	521103	Ref. No. —
	nut thread M4 H 3mm WS 7 brass Qty 20 pcs		
	Part No.	521104	Ref. No. —
	washer ID ø 4.3mm ED ø 8mm thickness 0.5mm brass Qty 20 pcs for thread M4		
	Part No.	521110	Ref. No. —
	flat gasket fibre ED ø 20mm ID ø 13mm thickness 2mm Qty 1 pcs		
	Part No.	521131	Ref. No. —
	nut thread M12x1 H 3.5mm WS 17 SS Qty 1 pcs		
	Part No.	528110	Ref. No. —
	O-ring EPDM thickness 2.62mm ID ø 12.37mm Qty 1 pcs		
	Part No.	560111	Ref. No. —
	plain washer ID ø 4.3mm ED ø 9mm thickness 0.8mm SS Qty 20 pcs DIN 125A for thread M4		
	Part No.	560131	Ref. No. —
	hexagonal nut thread M4 H 3.2mm WS 7 SS DIN/ISO DIN 934 / ISO 4032/8673 Qty 20 pcs		

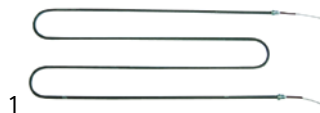

			
1			
Part No.	415525	Ref. No.	E318053 ELE318053 P0155
description	heating element 1100W 380V L 716mm W 205mm thread M15x1 mounting distance 197mm connection length 40mm tube ø 8mm cable length 980mm heating circuits 1 dry heating element 2 hole fixing		

			
1			
Part No.	415527	Ref. No.	E318055 ELE318055 P0161
description	heating element 1500W 220V L 720mm W 260mm thread M14x1.5 mounting distance 252mm tube ø 8.5mm cable length 1000mm heating circuits 1 dry heating element 2 hole fixing		





			
1			
Part No.	415526	Ref. No.	E318054 ELE318054 P0160
description	heating element 1500W 380V L 720mm W 260mm thread M14x1.5 mounting distance 290mm connection cable tube ø 8.5mm cable length 1000mm heating circuits 1 dry heating element 2 hole fixing		

			
1			
Part No.	415528	Ref. No.	E318050 ELE318050 P0150
description	heating element 2000W 230V L 465mm W 450mm thread M14x1.5 mounting distance 441mm connection length 36mm tube ø 8.5mm cable length 430mm heating circuits 1 dry heating element 2 hole fixing		
spare parts for	415528		
	Part No.	510417	Ref. No. —
	flat gasket fibre ED ø 20mm ID ø 14mm thickness 2mm Qty 1 pcs		
accessories for	415528		
	Part No.	361182	Ref. No. —
	nut thread 1/4" H 5mm nickel-plated brass WS 17 Qty 1 pcs		
	Part No.	520228	Ref. No. —
	tooth lock washer ID ø 15.3mm ED ø 24mm steel Qty 1 pcs for thread M14		
	Part No.	550262	Ref. No. —
	flat gasket copper ED ø 20mm ID ø 14mm thickness 2mm		

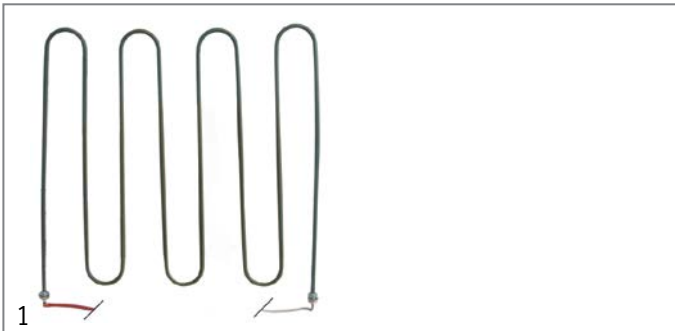
heating elements for pizza ovens

			
1			
Part No.	415524	Ref. No.	E318052 ELE318052 P0154
description	heating element 1100W 230V L 720mm W 200mm thread M14x1.5 mounting distance 210mm connection length 40mm tube ø 8.5mm cable length 1000mm heating circuits 1 dry heating element 2 hole fixing		
accessories for	415524		
	Part No.	361182	Ref. No. —
	nut thread 1/4" H 5mm nickel-plated brass WS 17 Qty 1 pcs		
	Part No.	510417	Ref. No. —
	flat gasket fibre ED ø 20mm ID ø 14mm thickness 2mm Qty 1 pcs		
	Part No.	520228	Ref. No. —
	tooth lock washer ID ø 15.3mm ED ø 24mm steel Qty 1 pcs for thread M14		
	Part No.	550262	Ref. No. —
	flat gasket copper ED ø 20mm ID ø 14mm thickness 2mm		



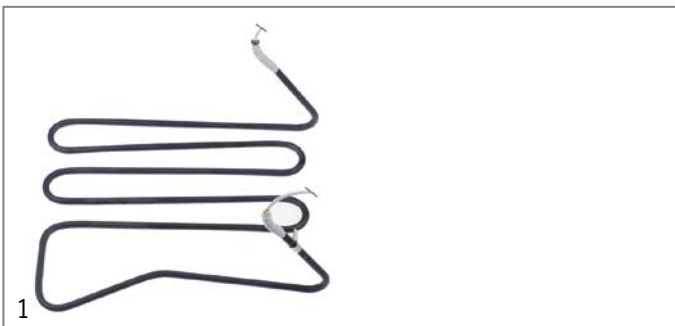

Part No.	416432	Ref. No.	E318051 ELE318051 P0151
description	heating element 2500W 230V L 575mm W 570mm thread M14x1.5 mounting distance 561mm connection length 37mm tube ø 8.7mm cable length 570mm heating circuits 1 dry heating element 2 hole fixing		
accessories for	416432		
	Part No.	510417	Ref. No. —
	flat gasket fibre ED ø 20mm ID ø 14mm thickness 2mm Qty 1 pcs		
	Part No.	520228	Ref. No. —
	tooth lock washer ID ø 15.3mm ED ø 24mm steel Qty 1 pcs for thread M14		
	Part No.	520230	Ref. No. —
	nut thread M14x1.5 H 5mm WS 19 zinc-coated steel Qty 1 pcs		
	Part No.	521101	Ref. No. —
	nut thread M14x1.5 H 5mm WS 19 SS Qty 1 pcs		
	Part No.	550262	Ref. No. —
	flat gasket copper ED ø 20mm ID ø 14mm thickness 2mm		

heating elements for salamanders/toast-



Part No.	415541	Ref. No.	318048 T0119
description	heating element 2000W 230V heating circuits 1 mounting pos. left L 250mm W 210mm H 120mm W2 170mm connection distance 164mm tube ø 6.3mm cable length 500mm dry heating element salamander grill		



Part No.	415540	Ref. No.	318049 T0120
description	heating element 2000W 230V heating circuits 1 mounting pos. right L 250mm W 210mm H 120mm W2 170mm connection distance 164mm tube ø 6.5mm cable length 500mm dry heating element salamander grill		

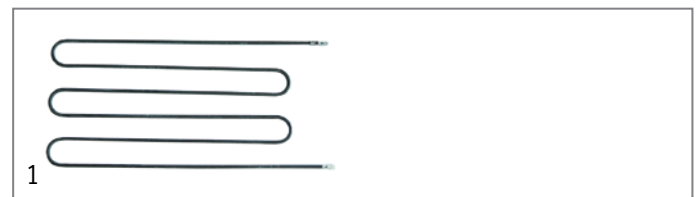

Part No.	415539	Ref. No.	127132 E318011 EL0127132 ELE318011 R0205
description	heating element 2100W 220V heating circuits 1 L 470mm W 207mm connection male faston 6.3mm connection distance 201mm tube ø 6.3mm dry heating element H 6.3mm		



Part No.	415538	Ref. No.	102644 E318010 EL0102644 ELE318010 R0200
description	heating element 2200W 230V heating circuits 1 L 365mm W 178mm connection male faston 6.3mm connection distance 172mm tube ø 6.3mm dry heating element H 6.3mm		

immersion heating elements







Part No.	415438	Ref. No.	E318038 ELE318038 R0295
description	heating element 4000W 220V L 430mm W 30mm H 37mm mounting distance 22mm thread M12x1 connection M4 tube ø 8.5mm 2 hole fixing immersion heater		
accessories for	415438		
	Part No.	510413	Ref. No. —
	flat gasket L 43mm W 19mm hole ø 12mm hole distance 24mm copper thickness 2.3mm for heating element		
	Part No.	520229	Ref. No. —
	nut thread M12x1 H 4mm WS 16 zinc-coated steel Qty 1 pcs		

Table continues overleaf



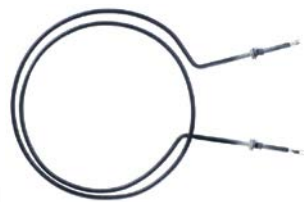

accessories for	415438			
	Part No.	521103	Ref. No.	—
	nut thread M4 H 3mm WS 7 brass Qty 20 pcs			
	Part No.	521104	Ref. No.	—
	washer ID ø 4.3mm ED ø 8mm thickness 0.5mm brass Qty 20 pcs for thread M4			
	Part No.	521110	Ref. No.	—
	flat gasket fibre ED ø 20mm ID ø 13mm thickness 2mm Qty 1 pcs			
	Part No.	521131	Ref. No.	—
	nut thread M12x1 H 3.5mm WS 17 SS Qty 1 pcs			
	Part No.	528110	Ref. No.	—
	O-ring EPDM thickness 2.62mm ID ø 12.37mm Qty 1 pcs			
	Part No.	560111	Ref. No.	—
	plain washer ID ø 4.3mm ED ø 9mm thickness 0.8mm SS Qty 20 pcs DIN 125A for thread M4			
	Part No.	560131	Ref. No.	—
	hexagonal nut thread M4 H 3.2mm WS 7 SS DIN/ISO DIN 934 / ISO 4032/8673 Qty 20 pcs			



		1	
Part No.	418897	Ref. No.	318004 576344 E318004 E318090 EL0576344 EL0581984 ELE318004 ELE318090 R0188
description	heating element 1600W 230V heating circuits 1 ID ø 220mm ED ø 240mm L 330mm L1 90mm thread M10x1 connection male faston 6.3mm tube ø 6.5mm convection heating element for combi-steamer		
For models:	ELH53, ELH5-3-McDonalds, MD523		

		1	
Part No.	419254	Ref. No.	EL0501247
description	heating element 600W 230V heating circuits 1 L 340mm W 45mm H 55mm L1 40mm L2 30mm L3 270mm thread M10x1 mounting distance 40mm tube ø 6.5mm connection length 20mm 2 hole fixing connection male faston 6.3mm		

		1	
Part No.	419252	Ref. No.	EL0584126 ELE318091
description	heating element 2000W 230V heating circuits 1 ID ø 180mm ED ø 193mm L 258mm H 25mm L1 60mm W1 30mm H1 7mm H2 18mm flange length 70mm flange width 22mm hole distance 56mm connection male faston 6.3mm connection length 55mm tube ø 6.5mm convection heating element hole ø M4mm rectangular flange		







heating elements for convection

		1		
Part No.	418739	Ref. No.	318105 742414 EL0742414 ELE318105	
description	heating element 10500W 230V heating circuits 3 ID ø 411mm ED ø 428mm L 480mm H 110mm L1 52mm W1 99mm H1 18mm H2 92mm flange length 130mm flange width 54mm hole distance 55mm connection M5 connection length 96mm tube ø 8.5mm convection heating element mounting thread M6 rectangular flange with thread bolt			
For models:	1011, 2011, 611, AUTOCLEAN, GENIUS, GENIUS6-11, MAKT, MB, MULTIMAXA, MULTIMAXB			
accessories for	418739			
	Part No.	551240	Ref. No.	749451 E427064 EL0749451 ELE427064
	gasket L 129mm W 87mm D1 ø 12mm D2 ø 7mm 12 holes graphite thickness 1mm			

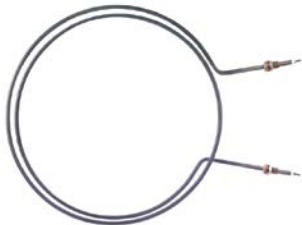



		1		
Part No.	418959	Ref. No.	742422 E318106 EL0742422 ELE318106	
description	heating element 21600W 230V heating circuits 6 ID ø 414mm ED ø 466mm L 522mm H 121.5mm L1 88mm W1 97mm H1 30.5mm H2 91mm flange length 130mm flange width 88mm connection M5 connection length 70mm tube ø 6.5mm mounting thread M6 flange with bolt M6			
For models:	1011, 2011, 611, AUTOCLEAN, GENIUS, MAKT, MB, MULTIMAXA, MULTIMAXB			
accessories for	418959			
	Part No.	519647	Ref. No.	E412169 EL0757993 ELE412169
	counterflange ø 8mm perforation ø 13mm L 130mm W 88mm suitable for convection heating element 12 holes			
	Part No.	551240	Ref. No.	749451 E427064 EL0749451 ELE427064
	gasket L 129mm W 87mm D1 ø 12mm D2 ø 7mm 12 holes graphite thickness 1mm			









			
1			
Part No.	420300	Ref. No.	318071 318087 590118 E318087 EL0318087 EL0590118 ELE318087
description	heating element 3400W 230V heating circuits 1 ID \varnothing 200mm ED \varnothing 212mm L 268mm H 33mm L1 50mm W1 30mm H1 5mm H2 30mm flange length 70mm flange width 22mm hole distance 56mm connection male faston 6.3mm tube \varnothing 6.5mm convection heating element hole \varnothing 3.5mm flange		
For models:	EB30, EB30XLDIGITAL, EBM3e-McDonalds		

			
1			
Part No.	418766	Ref. No.	E318002 ELE318002 R0184
description	heating element 4500W 230V heating circuits 1 ID \varnothing 380mm ED \varnothing 405mm L 530mm H 17mm thread M14x1.5 connection M4 tube \varnothing 8.5mm		
For models:	MD1011, MD2011, MMD1011, MMD2011		
spare parts for	418766		
	Part No.	510417	Ref. No. —
	flat gasket fibre ED \varnothing 20mm ID \varnothing 14mm thickness 2mm Qty 1 pcs		
accessories for	418766		
	Part No.	520228	Ref. No. —
	tooth lock washer ID \varnothing 15.3mm ED \varnothing 24mm steel Qty 1 pcs for thread M14		
	Part No.	520230	Ref. No. —
	nut thread M14x1.5 H 5mm WS 19 zinc-coated steel Qty 1 pcs		
	Part No.	521101	Ref. No. —
	nut thread M14x1.5 H 5mm WS 19 SS Qty 1 pcs		
	Part No.	550262	Ref. No. —
	flat gasket copper ED \varnothing 20mm ID \varnothing 14mm thickness 2mm		





			
1			
Part No.	415805	Ref. No.	693383 E318078 EL0693383 ELE318078
description	heating element 5700W 230V heating circuits 3 ID \varnothing 206mm ED \varnothing 245mm L 290mm H 42mm L1 45mm W1 97mm H1 2mm H2 40mm flange length 110mm flange width 20mm hole distance 35mm connection male faston 6.3mm connection length 58mm tube \varnothing 6.3mm convection heating element hole \varnothing 6.5mm rectangular flange		
For models:	EB30, JOKERB, JOKERC		







			
1			
Part No.	415133	Ref. No.	318017 ELE318017
description	heating element 1430W 230V heating circuits 1 L 85mm W 395mm connection male faston 6.3mm tube \varnothing 6.3mm thread M10x1 2 hole fixing dry heating element mounting distance 389mm		
For models:	EBM5, ELH61, MD2011, MD611, MMC2011, MMC611, MMD2011, MMD611		
accessories for	415133		
	Part No.	520231	Ref. No. —
	nut thread M10x1 H 6mm WS 14 zinc-coated steel Qty 1 pcs		
	Part No.	521129	Ref. No. —
	nut thread M10 H 6mm SS WS 17 Qty 1 pcs DIN/ISO DIN 439		
	Part No.	528433	Ref. No.
	flat gasket copper ED \varnothing 14mm ID \varnothing 10mm thickness 1mm		
			097071 217840 E427020 E427039 EL0097071 EL0217840 EL0571849 ELE427020 ELE427039 R0300



			
Part No.	415221	Ref. No.	332429 E318045 ELO332429 ELE318045 R0305
description	heating element 1430W 230V heating circuits 1 L 90mm W 390mm connection male faston 6.3mm tube ø 6.3mm thread M10x1 2 hole fixing dry heating element mounting distance 376mm		
For models:	MD611, MMD611		
spare parts for	415221		
	Part No.	510416	Ref. No. —
	flat gasket fibre ED ø 19mm ID ø 10.5mm thickness 1.5mm for thread M10 Qty 1 pcs		
accessories for	415221		
	Part No.	510893	Ref. No. —
	O-ring EPDM thickness 2.62mm ID ø 9.92mm Qty 1 pcs		
	Part No.	520231	Ref. No. —
	nut thread M10x1 H 6mm WS 14 zinc-coated steel Qty 1 pcs		
	Part No.	521129	Ref. No. —
	nut thread M10 H 6mm SS WS 17 Qty 1 pcs DIN/ISO DIN 439		
	Part No.	528433	Ref. No. 097071 217840 E427020 E427039 ELO097071 ELO217840 ELO571849 ELE427020 ELE427039 R0300
	flat gasket copper ED ø 14mm ID ø 10mm thickness 1mm		

			
Part No.	418970	Ref. No.	585726 ELO585726 ELO585726
description	heating element 1450W 230V heating circuits 1 L 90mm W 315mm		

			
Part No.	415222	Ref. No.	318018 576581 E318082 ELO576581 ELE318082
description	heating element 2300W 230V heating circuits 1 L 90mm W 395mm connection M4 tube ø 8.5mm thread M14x1.5 2 hole fixing dry heating element		
For models:	ELH101, MD1011, MD2011, MMC1011, MMC2011, MMD1011, MMD2011		
accessories for	415222		
	Part No.	521103	Ref. No. —
	nut thread M4 H 3mm WS 7 brass Qty 20 pcs		
	Part No.	521104	Ref. No. —
	washer ID ø 4.3mm ED ø 8mm thickness 0.5mm brass Qty 20 pcs for thread M4		
	Part No.	560111	Ref. No. —
	plain washer ID ø 4.3mm ED ø 9mm thickness 0.8mm SS Qty 20 pcs DIN 125A for thread M4		
	Part No.	560131	Ref. No. —
	hexagonal nut thread M4 H 3.2mm WS 7 SS DIN/ISO DIN 934 / ISO 4032/8673 Qty 20 pcs		

			
Part No.	415542	Ref. No.	318047 E318084 ELE318047 ELE318084 R0321
description	heating element 2500W 230V heating circuits 1 L 131mm W 485mm connection length 20mm connection M4 tube ø 8.5mm thread M14x1.5 2 hole fixing convection heating element mounting distance 480mm		
For models:	MMC2021, MMD2021		
accessories for	415542		
	Part No.	510417	Ref. No. —
	flat gasket fibre ED ø 20mm ID ø 14mm thickness 2mm Qty 1 pcs		
	Part No.	520228	Ref. No. —
	tooth lock washer ID ø 15.3mm ED ø 24mm steel Qty 1 pcs for thread M14		
	Part No.	520230	Ref. No. —
	nut thread M14x1.5 H 5mm WS 19 zinc-coated steel Qty 1 pcs		
	Part No.	521101	Ref. No. —
	nut thread M14x1.5 H 5mm WS 19 SS Qty 1 pcs		
	Part No.	550262	Ref. No. —
	flat gasket copper ED ø 20mm ID ø 14mm thickness 2mm		



			
1			
Part No.	415543	Ref. No.	E318083 ELE318083 R0320
description	heating element 4000W 230V heating circuits 1 L 131mm W 485mm connection M4 tube ø 8.5mm thread M14x1.5 2 hole fixing dry heating element		
For models:	MMD2021		

energy regulators

EGO

1-circuit

			
1			
Part No.	380015	Ref. No.	314544 E0180 E344009 ELO314544 ELE344009
description	energy regulator 230V 13A single-circuit turn direction right shaft ø 6x4.6mm shaft L 23mm mounting thread M4 power release 6-100% no. 50.57021.010		

accessories

knobs

			
1			
Part No.	110235	Ref. No.	E0322
description	knob energy regulator 1-3 t.max.°C ø 50mm shaft ø 6x4.6mm shaft flat upper black		

thermostats

control and safety thermostats

EGO

control thermostats

55.10/19_ series

			
1			
Part No.	375070	Ref. No.	091634 E0268 E334007 EL0091634 ELE334007
description	thermostat t.max. 250°C temperature range 55-250°C 1-pole 1CO 16A probe ø 3.1mm probe L 226mm capillary pipe 1170mm capillary pipe isolated 1100mm gland nut M9x1 shaft L 23mm shaft position upper rotation 270°		
For models:	1011, 611, AUTOCLEAN, JOKERB, JOKERC, MD1011, MD2011, MD523, MD611, MMD1011, MMD2011, MMD2021, MMD611, MULTIMAXA, WU14		

			
1			
Part No.	375462	Ref. No.	E0250 E334002 ELE334002
description	thermostat t.max. 250°C temperature range 55-250°C 1-pole 1NO 16A probe ø 3.1mm probe L 226mm capillary pipe 2420mm capillary pipe isolated 1100mm gland nut shaft ø 6x4.6mm shaft L 23mm shaft position upper rotation 270°		



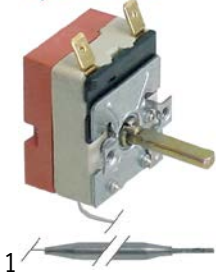

55.13_ series

Part No.	375179	Ref. No.	E0260 E334006 ELE334006
description	thermostat t.max. 131°C temperature range 80-131°C 1-pole 1NO 16A probe ø 6mm probe L 98mm capillary pipe 1730mm capillary pipe isolatedmm gland nut shaft ø 6x4.6mm shaft L 23mm shaft position upper rotation 270°		

55.31_ series

Part No.	375072	Ref. No.	E0160 E336001 ELE336001
description	safety thermostat switch-off temp. 170°C 3-pole 20A probe ø 3.1mm probe L 524mm capillary pipe 350mm capillary pipe isolated 350mm gland nut probe SS		

55.34_ series

Part No.	375101	Ref. No.	E334008 ELE334008 P0180
description	thermostat t.max. 360°C temperature range 140-360°C 3-pole 3NO 16A probe ø 4mm probe L 292mm capillary pipe 990mm capillary pipe isolated 500mm gland nut shaft L 23mm shaft position upper rotation 318°		

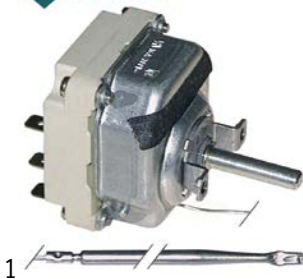
55.32_ series

Part No.	390921	Ref. No.	336003 572705 EL0572705
description	safety thermostat switch-off temp. 305°C 3-pole 3NC 20A probe ø 4mm probe L 128mm capillary pipe 890mm capillary pipe isolated 800mm gland nut probe		
For models:	ELH101, ELH51, ELH53, ELH5-3-McDonalds, ELH61, MD1011, MD523, MD611		

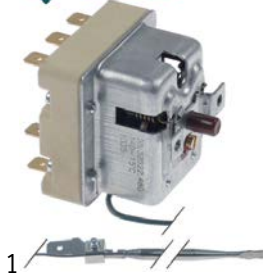
safety thermostats

55.11_ series



Part No.	375093	Ref. No.	E0232 E336004 ELE336004
description	safety thermostat switch-off temp. 318°C 1-pole 12A probe ø 4mm probe L 111mm capillary pipe 530mm capillary pipe isolated 450mm gland nut M9x1 probe SS		
For models:	MD1011, MD2011, MD523, MD611, MMD1011, MMD2011, MMD2021, MMD611		



Part No.	375065	Ref. No.	E0234 E336005 ELE336005
description	safety thermostat switch-off temp. 500°C 3-pole 3NC 20A probe ø 4mm probe L 308mm capillary pipe 890mm capillary pipe isolatedmm gland nut probe SS		



55.33_ series



Part No.	375075	Ref. No.	384429 E0240 E336017 EL0384429 ELE336017
description	safety thermostat switch-off temp. 305°C 3-pole probe		

accessories



Part No.	518669	Ref. No.	0373079 EL0373079
description	gasket PTFE ED ø 21mm ID ø 15mm thickness 3.5mm		
accessories for	518669		
	Part No.	375889	Ref. No. 504602 E336029 EL0504602 ELE336029
description	safety thermostat switch-off temp. 360°C 1-pole 16A probe ø 15mm probe L 6.5mm capillary pipe 1140mm capillary pipe isolated 1100mm gland nut probe		

control thermostats with actual value



Part No.	375118	Ref. No.	580457 E336027 EL0580457 ELE336027
description	safety thermostat switch-off temp. 360°C 3-pole 20A probe ø 15mm probe L 8mm capillary pipe 1150mm capillary pipe isolated 1100mm gland nut probe with knob		



Part No.	379034	Ref. No.	E336015 ELE336015 P0183
description	thermostat t.max. 450°C temperature range 50-450°C 1-pole 100 5A probe ø 6mm probe L 30mm capillary pipe 1150mm capillary pipe isolated 1100mm gland nut mounting ø 80mm mounting measurements 96x96mm		

56._ series

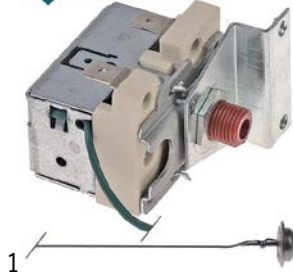

Part No.	375889	Ref. No.	504602 E336029 EL0504602 ELE336029
description	safety thermostat switch-off temp. 360°C 1-pole 16A probe ø 15mm probe L 6.5mm capillary pipe 1140mm capillary pipe isolated 1100mm gland nut probe		
For models:	1011, 1221, 2011, 2021, 611, AUTOCLEAN, EB30, EB30XLDIGITAL, GENIUS, GENIUS6-11, GENIUS6-11GAS, GENIUSGAS, JOKERB, JOKERC, MAKT, MB, MULTIMAXA, MULTIMAXB, MULTIMAXB6-11AUTOCLEAN		
accessories for	375889		
	Part No.	518669	Ref. No. 0373079 EL0373079
description	gasket PTFE ED ø 21mm ID ø 15mm thickness 3.5mm		

switches and momentary switches



rocker/momentary rocker switches

30x22mm



Part No.	301003	Ref. No.	E320032 ELE320032 P0187
description	rocker switch mounting measurements 30x22mm green 2NO 250V 16A illuminated 0-1 connection male faston 6.3mm ambient temperature max. 125/55°C protection IP65		
accessories for	301003		
	Part No.	301036	Ref. No. —
description	protective cover internal size 30x22mm for rocker switch mounting measurementsmm		



 <p>1</p>			
Part No.	301001	Ref. No.	E320030 ELE320030 P0185
description	rocker switch mounting measurements 30x22mm red 2NO 250V 16A illuminated 0-1 connection male faston 6.3mm ambient temperature max. 125/55°C protection IP65		
accessories for	301001		
	Part No.	301036	Ref. No. —
	 protective cover internal size 30x22mm for rocker switch mounting measurementsmm		

microswitches

universal



<p>1</p>			
Part No.	345042	Ref. No.	570540 E320055 EL0570540 ELE320055
description	microswitch with plunger 250V 16A 1CO connection male faston 6.3mm L 28mm ambient temperature max. 125°C mounting distance 22mm type EF83161.3 actuating force: 75g blue/black		
For models:	EB30, EB30XLDIGITAL, JOKERB, JOKERC		
accessories for	345042		
	Part No.	345043	Ref. No. —
	 lever set 5-piece		

pin-plunger actuated



<p>1</p>			
Part No.	345042	Ref. No.	570540 E320055 EL0570540 ELE320055
description	microswitch with plunger 250V 16A 1CO connection male faston 6.3mm L 28mm ambient temperature max. 125°C mounting distance 22mm type EF83161.3 actuating force: 75g blue/black		
For models:	EB30, EB30XLDIGITAL, JOKERB, JOKERC		
accessories for	345042		
	Part No.	345043	Ref. No. —
	 lever set 5-piece		

M16

 <p>1</p>			
Part No.	345046	Ref. No.	092444 E0290 E320036 EL0092444 ELE320036 V0600
description	microswitch with plunger thread M16x1 thread L 25mm 250V 5A 1NC/1NO connection male faston 6.3mm stroke 6mm ambient temperature max. 85°C actuating force: 400g		
For models:	MD1011, MD2011, MD523, MD611, MMD1011, MMD2011, MMD2021, MMD611		

accessories

 <p>1</p>			
Part No.	347013	Ref. No.	E320058 EL0587141
description	lever for microswitch		
For models:	JOKERB, JOKERC		

cam switches

4-position

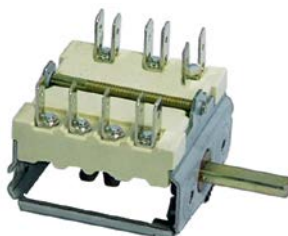
 <p>1</p>			
Part No.	300016	Ref. No.	E0185
description	cam switch 4 operating positions 1NO/2CO sequence 0-1-2-3 16A shaft ø 6x4.6mm shaft L 23mm connection male faston 6.3mm ceramic		

 <p>1</p>			
Part No.	300104	Ref. No.	532215 E0187 E320003 EL0532215 ELE320003
description	cam switch 4 operating positions 3NO/1CO sequence 0-1-2-3 32A shaft ø 6x4.6mm shaft L 23mm connection screw ceramic		



4 operating positions

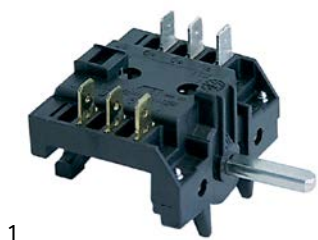

1

Part No.	300033	Ref. No.	E0190 E320005 ELE320005
description	cam switch 4 operating positions 4NO sequence 0-1-2-3 16A shaft \varnothing 6x4.6mm shaft L 23mm connection male faston 6.3mm plastic		



1

Part No.	300057	Ref. No.	292664 E0194 E320008 EL0292664 ELE320008
description	cam switch 4 operating positions 6NO sequence 0-1-2-3 16A shaft \varnothing 6x4.6mm shaft L 23mm connection male faston 6.3mm 6CH/141 plastic		
For models:	MD1011, MD523, MD611		



1

Part No.	348195	Ref. No.	320009 EL0553611
description	cam switch 4 operating positions 9NO sequence 0-1-2-3 16A shaft \varnothing 6x4.6mm shaft L 23mm connection F6.3 outer switch		
For models:	ELH101, ELH53, ELH5-3-McDonalds, ELH61		



1

Part No.	300034	Ref. No.	E0193
description	cam switch 4 operating positions selector switch sequence 0-1-2-3 16A shaft \varnothing 6x4.6mm connection male faston 6.3mm 4-pole		

5 operating positions



1

Part No.	345199	Ref. No.	E320034 ELE320034 T0133
description	cam switch 5 operating positions 2NO/1CO sequence 0-1-2-3-4 16A shaft \varnothing 6x4.6mm shaft L 23mm connection male faston 6.3mm		

operation switches



1

Part No.	345321	Ref. No.	E0189 E320004 ELE320004
description	operation switch 4 operating positions 5NO 16A sequence 0-1-2-3 shaft \varnothing 6x4.6mm shaft L 23mm connection male faston 6.3mm plastic 3-pole ambient temperature max. 300°C		

magnetic switches

 \varnothing 5.22mm

1

Part No.	347011	Ref. No.	581038 E320072 EL0581038 ELE320072
description	magnetic switch 250V 0.04A P max. 10W probe L 26mm 1NO cable length 1000mm		
For models:	1011, 1221, 2011, 2021, 611, AUTOCLEAN, GENIUS, GENIUS6-11, GENIUS6-11GAS, GENIUSGAS, MAKT, MB, MULTIMAXA, MULTIMAXB		



M12x1

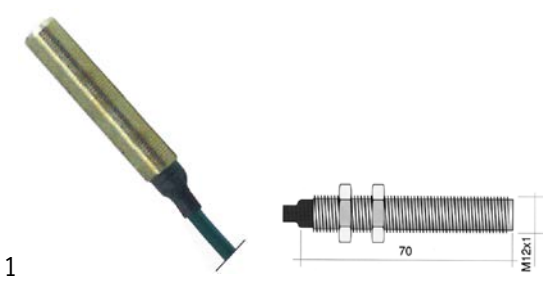

Part No.	345135	Ref. No.	372986 E1029 E320048 EL0372986 ELE320048
description	magnetic switch thread M12x1 1NO 250V 3A P max. 100W connection cable length 2000mm L 72mm type 122		
For models:	JOKERB, JOKERC		





Part No.	346188	Ref. No.	580341 E320069 EL0580341 ELE320069
description	momentary switch unit mounting measurements ø16/24x24mm type momentary black/white square		

control equipment

SCHLEGEL

switches (complete)



Part No.	359755	Ref. No.	507684 EL0507684
description	switch mounting measurements ø16/24x24mm white square 1NO/1NC/indicator light rotation° sequence 0-1 complete type BFL5		
spare parts for	359755		
	Part No.	Ref. No.	580341 E320069 EL0580341 ELE320069
	momentary switch unit mounting measurements ø16/24x24mm type momentary black/white square		
	Part No.	Ref. No.	—
	light bulb socket T5.5K 48V 3W ø 5.5mm L 22mm clear		

symbol plates





Part No.	359757	Ref. No.	580368 E358046 EL0580368 ELE358046
description	symbol plate octagonal white ON-OFF		

switch blocks



Part No.	359194	Ref. No.	E0790 E320026 EL0590045 ELE320026
description	contact block latching 1NC/1NO connection male faston 2.8mm illuminable socket T5.5K type AFL		
For models:	1011, 2011, 611, JOKERB, MULTIMAXA		



Part No.	359756	Ref. No.	580384 E320070 EL0580384 ELE320070
description	contact block latching 1NO/1NC connection male faston 2.8mm illuminable socket T5.5K type BFL5		
accessories for	359756		
	Part No.	Ref. No.	—
	light bulb socket T5.5K 60V 0.02A		

push buttons



Part No.	359183	Ref. No.	332712 E0586 E322022 EL0332712 ELE322022
description	momentary switch unit mounting measurements ø16/24x24mm type momentary anthracite/transparent square		
For models:	MD1011, MD523, MD611		





			
1			
Part No.	359184	Ref. No.	323535 E0786 E320024 ELO323535 ELE320024
description	contact block momentary 1NC/1NO connection male faston 2.8mm socket type AT		
For models:	MD1011, MD523, MD611		

accessories

			
1			
Part No.	359768	Ref. No.	580376 E320068 EL0580376 ELE320068
description	cap for momentary switch transparent/colourless octagonal L 19.4mm W 19.4mm		

encoders and potentiometers

			
1			
Part No.	300263	Ref. No.	E340083 EL0340083 ELE340083
description	encoder rotation 360° shaft ø 6mm shaft L 13mm 0.1W		

			
1			
Part No.	300062	Ref. No.	E606002 ELE606002
description	potentiometer 2x2KOhm		

lamps

indicator lights

indicator lights 3-piece (housing, lens and bulb)

ø16.2mm

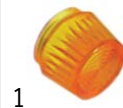

1

Part No.	359070	Ref. No.	E0275 E314003 ELE314003
description	indicator light lens yellow		

lamps

neon light bulbs



1

Part No.	359600	Ref. No.	E0560 E312001 ELE312001
description	neon light bulb socket E10 220V 0.35W clear ø 10mm L 28mm		

accessories for 359600



	Part No.	359060	Ref. No.	—
lamp socket mounting measurements ø16.2mm socket E10 connection screw				
	Part No.	359063	Ref. No.	—
lamp socket mounting measurements ø19.2mm socket E14 connection screw				
	Part No.	359064	Ref. No.	—
lamp socket mounting measurements ø22.3mm socket E14 connection screw 250/380V ambient temperature at 1W 100°C ambient temperature at 2W 85°C				
	Part No.	359685	Ref. No.	—
lamp socket mounting measurements ø16.2mm socket E10				
	Part No.	359832	Ref. No.	—
lamp socket mounting measurements ø16.2mm socket Ba9s connection male faston 6.3mm				
	Part No.	359853	Ref. No.	—
lamp socket mounting measurements ø18.2mm socket Ba9s connection male faston 6.3mm				
	Part No.	359988	Ref. No.	—
lamp socket mounting measurements ø30.5mm 250V connection F6.3 temp.-resist. 55°C E14				



indicator lights (complete)			
ø 6mm			
 <p>1</p>			
Part No.	359004	Ref. No.	332771 E0960 E0960E E314010 EL0332771 ELE314010
description	indicator light ø 6mm 230V green cable length 400mm temp.-resist. 106°C		
For models:	MD1011, MD2011, MD523, MD611		

 <p>1</p>			
Part No.	359005	Ref. No.	314011 332798 E0961 E314011 EL0332798 ELE314011
description	indicator light ø 6mm 230V yellow cable length 400mm		
For models:	EBM5, ELH101, ELH53, ELH5-3-McDonalds, ELH61, MD1011, MD2011, MD523, MD611		

ø10mm			
with plug-in socket			
 <p>1</p>			
Part No.	359140	Ref. No.	E0278 E314002 E314018 EL0091642 ELE314018
description	indicator light ø 10mm yellow 230V connection male faston 6.3mm Qty 1 pcs		

30x22mm			
 <p>1</p>			
Part No.	359157	Ref. No.	E314021 ELE314021 P0191
description	indicator light mounting measurements 30x22mm 230V green connection male faston 6.3mm temp.-resist. 125/55°C type RL2		
accessories for	359157		
	Part No.	301036	Ref. No. —
protective cover internal size 30x22mm for rocker switch mounting measurementsmm			

 <p>1</p>			
Part No.	359156	Ref. No.	E314020 ELE314020 P0190
description	indicator light mounting measurements 30x22mm 230V yellow connection male faston 6.3mm temp.-resist. 125/55°C type RL2		

screw-on/push-on fit

neon light bulbs			
 <p>1</p>			
Part No.	359600	Ref. No.	E0560 E312001 ELE312001
description	neon light bulb socket E10 220V 0.35W clear ø 10mm L 28mm		
accessories for	359600		
	Part No.	359060	Ref. No. —
lamp socket mounting measurements ø16.2mm socket E10 connection screw			
	Part No.	359063	Ref. No. —
lamp socket mounting measurements ø19.2mm socket E14 connection screw			
	Part No.	359064	Ref. No. —
lamp socket mounting measurements ø22.3mm socket E14 connection screw 250/380V ambient temperature at 1W 100°C ambient temperature at 2W 85°C			
	Part No.	359685	Ref. No. —
lamp socket mounting measurements ø16.2mm socket E10			
	Part No.	359832	Ref. No. —
lamp socket mounting measurements ø16.2mm socket Ba9s connection male faston 6.3mm			
	Part No.	359853	Ref. No. —
lamp socket mounting measurements ø18.2mm socket Ba9s connection male faston 6.3mm			
	Part No.	359988	Ref. No. —
lamp socket mounting measurements ø30.5mm 250V connection F6.3 temp.-resist. 55°C E14			

light bulbs

for ovens			
 <p>1</p>			
Part No.	359610	Ref. No.	E0565 E312004 ELE312004
description	light bulb t.max. 300°C socket E14 15W 230V ø 22mm L 47mm lens L 20mm for oven lamp type Philips		



PHILIPS



1

Part No.	359612	Ref. No.	354252 E0566 E312003 EL0354252 ELE312003
description	light bulb t.max. 300°C socket E14 25W 230V ø 25mm L 56mm lens L 30mm for oven lamp type Philips		
For models:	MD1011, MD2011, MD523, MD611, MMD1011, MMD2011, MMD2021, MMD611		

miscellaneous



1

Part No.	362023	Ref. No.	581488 E0826 E312012 EL0581488 ELE312012
description	light bulb socket T5.5K 48V 1.2W 0.025A		
For models:	1011, 2011, 611, EB30, EB30XLDIGITAL, JOKERB, MULTIMAXA		

halogen lamp

for socket G4 / G6.35 / G9



1

Part No.	359596	Ref. No.	571954 E312023 EL0571954 ELE312023
description	halogen lamp socket G4 12V 10W temp.-resist. 500°C		
For models:	EB30		



1

Part No.	359599	Ref. No.	570478 E312021 EL0570478 ELE312021
description	halogen lamp socket G4 12V 20W temp.-resist. 500°C		
For models:	1011, 1221, 2011, 2021, 611, AUTOCLEAN, EB30XLDIGITAL, GENIUS, GENIUS6-11, GENIUS6-11GAS, GENIUSGAS, JOKERB, JOKERC, MAKT, MB, MULTIMAXA, MULTIMAXB		

linear lamps

infrared lamps

with base type R7s



1

Part No.	359628	Ref. No.	E0574 E312006 ELE312006
description	infrared lamp socket R7s L 117.6mm 240V 300W IMPORT unjacketed		



1

Part No.	359622	Ref. No.	EL0531332
description	infrared lamp socket Li_R base 230V 1000W L 428mm cable length 100mm		

with base type X lug



1

Part No.	359617	Ref. No.	531332 E0575 E0577 E312007 E312008 ELE312007 ELE312008
description	infrared lamp 1000W 220V L 365mm lens L 340mm total length 480mm with mounting strap		

sockets for linear lamps

X lug



1

Part No.	359710	Ref. No.	E0576 E314007 ELE314007
description	lamp socket L 70mm W 70mm H 49mm mounting distance 50mm bracket mounting		

fluorescent lamps

fluorescent lamps

2G11



1

Part No.	359640	Ref. No.	E1013 E312015 ELE312015
description	fluorescent lamp socket 2G11 L 217mm 18W 230V		



			
1			
Part No.	359634	Ref. No.	E1010 E312014 ELE312014
description	fluorescent lamp socket 2G11 L 411mm 36W 230V		

accessories





sockets

			
1			
Part No.	381156	Ref. No.	E1011 E314015 ELE314015
description	lamp socket socket 2G11 hole distance 24mm t.max. 140°C for fluorescent lamps		







oven lamps

universal oven lamps

mounting diameter 35.5mm

			
1			
Part No.	359701	Ref. No.	E0530 E314004 EL0527777 ELE314004
description	lamp socket socket E14 220-230V mounting ø 35.5mm connection male faston 6.3mm 15W		
For models:	MD1011, MD2011, MD523, MD611, MMD1011, MMD2011, MMD2021, MMD611		
accessories for	359701		
	Part No.	359705	Ref. No. 092339 E0555 E460003 EL0092339 ELE460003
oven lamp glass thr.ø 33.5mm ø 52mm hard glas temp.-resist. 350°C			
	Part No.	359709	Ref. No. E0532 E460002 ELE460002
oven lamp glass thr.ø 33.5mm ø 42mm hard glas temp.-resist. 350°C			
	Part No.	359721	Ref. No. 425132 693421 976024 E0556 E425005 E425132 EL0976024 ELE425005 ELE425132
gasket silicone ED ø 48mm ID ø 39.5mm thickness 5mm Qty 1 pcs			
	Part No.	359942	Ref. No. —
oven lamp glass thr.ø 33.5mm ø 41mm hard glas temp.-resist. 350°C			

			
1			
Part No.	359709	Ref. No.	E0532 E460002 ELE460002
description	oven lamp glass thr.ø 33.5mm ø 42mm hard glas temp.-resist. 350°C		
For models:	MD2011, MMD2011, MMD2021		

			
1			
Part No.	359705	Ref. No.	092339 E0555 E460003 EL0092339 ELE460003
description	oven lamp glass thr.ø 33.5mm ø 52mm hard glas temp.-resist. 350°C		
accessories for	359705		
	Part No.	359610	Ref. No. E0565 E312004 ELE312004
light bulb t.max. 300°C socket E14 15W 230V ø 22mm L 47mm lens L 20mm for oven lamp type Philips			
	Part No.	359700	Ref. No. —
gasket for pizza oven fibre glass ID ø 32.5mm ED ø 55mm thickness 5mm			
	Part No.	359721	Ref. No. 425132 693421 976024 E0556 E425005 E425132 EL0976024 ELE425005 ELE425132
gasket silicone ED ø 48mm ID ø 39.5mm thickness 5mm Qty 1 pcs			
	Part No.	359837	Ref. No. —
gasket ID ø 33mm ED ø 46mm thickness 1mm graphite			
	Part No.	359838	Ref. No. —
gasket ID ø 33mm ED ø 45mm			

			
1			
Part No.	359721	Ref. No.	425132 693421 976024 E0556 E425005 E425132 EL0976024 ELE425005 ELE425132
description	gasket silicone ED ø 48mm ID ø 39.5mm thickness 5mm Qty 1 pcs		
For models:	EBM3e-McDonalds, JOKERB, JOKERC		



producer-specific oven lamps

ELOMA



1

Part No.	357129	Ref. No.	EL0510288
description	lamp socket socket E14 hole distance 52x89mm mounting measurements 70x80mm		



1

Part No.	359639	Ref. No.	367664 B0382 E314001 EL0367664 ELE314001
description	lamp socket socket E14 with grip fixing		



1

Part No.	359068	Ref. No.	E314019 ELE314019 P0166
description	lamp socket with 2 hole fixing socket E14 ø 25mm		

lamps

light bulbs



1

Part No.	359610	Ref. No.	E0565 E312004 ELE312004
description	light bulb t.max. 300°C socket E14 15W 230V ø 22mm L 47mm lens L 20mm for oven lamp type Philips		



1

Part No.	359612	Ref. No.	354252 E0566 E312003 EL0354252 ELE312003
description	light bulb t.max. 300°C socket E14 25W 230V ø 25mm lens L 30mm for oven lamp type Philips		
For models:	MD1011, MD2011, MD523, MD611, MMD1011, MMD2011, MMD2021, MMD611		

halogen lamps

for socket G4 / G6.35 / G9



1

Part No.	359596	Ref. No.	571954 E312023 EL0570478 ELE312023
description	halogen lamp socket G4 12V 10W temp.-resist. 500°C		
For models:	EB30		



1

Part No.	359599	Ref. No.	570478 E312021 EL0570478 ELE312021
description	halogen lamp socket G4 12V 20W temp.-resist. 500°C		
For models:	1011, 1221, 2011, 2021, 611, AUTOCLEAN, EB30XLDIGITAL, GENIUS, GENIUS6-11, GENIUS6-11GAS, GENIUSGAS, JOKERB, JOKERC, MAKT, MB, MULTIMAXA, MULTIMAXB		

sockets

G4 / G5,3 / G6,35



1

Part No.	359646	Ref. No.	577294 E314031 EL0577294 ELE314031
description	lamp socket socket G4/G5.3/G6.35 24V ø 17mm H 15mm connection cable 130mm mounting distance 26mm for halogen lamp holder length 31mm cable length 130mm		
For models:	1011, 1221, 2011, 2021, 611, GENIUS, JOKERB, JOKERC, MAKT, MB		

timers

electric timers





1

Part No.	350191	Ref. No.	0157988
description	timer 1CO/1NO permanent position yes impulse electric shaft ø 6x4.6mm shaft L 23mm mounting distance 28mm connection lateral 2-pole operation time 120min		



			
1			
Part No.	350001	Ref. No.	E0205 E330006 ELE330006
description	timer 2CO at 250V 16A permanent position yes impulse electric shaft \varnothing 6x4.6mm shaft L 22mm mounting distance 28mm connection rear 2-pole operation time 120min		
For models:	MD1011, MD523, MD611		

			
1			
Part No.	350059	Ref. No.	871400 E598179 EL0871400 ELE598179
description	timer MS65 operation time 120min time spreadmin 2CO/1NO at 250V 16A permanent position yes impulse electric shaft \varnothing 6x4.6mm shaft L 20mm mounting distance 28mm mounting thread M4 connection lateral 3-pole		
accessories for	350059		
	Part No.	110366	Ref. No. —
	knob switch zero mark t.max. °C \varnothing 44mm shaft \varnothing 6x4.6mm shaft flat upper black		
	Part No.	110381	Ref. No. —
	dial plate graduation 120min permanent position yes rotation 0-300° \varnothing 60mm timers knob \varnothing 45mm with permanent position		

mechanical timers

			
1			
Part No.	350203	Ref. No.	592323 EL0505428 EL0592323
description	timer C20 2-pole operation time 15min impulse mechanical 2CO at 250V 16A permanent position no shaft \varnothing 6x4.6mm shaft 6x4.6mm shaft L 23mm mounting distance 28mm connection male faston 6.3mm ambient temperature max. 125°C		

audible timers

			
1			
Part No.	350014	Ref. No.	E330016 ELE330016 T0142
description	audible timer operation time 15min \varnothing 56mm shaft \varnothing 6x4.6mm shaft L 24mm mounting distance 28mm		

alarm devices

			
1			
Part No.	350051	Ref. No.	091472 E0225 E348002 EL0091472 ELE348002
description	buzzer 230VAC connection male faston 6.3mm screw thread M4 buzzer 62dB		
For models:	MD1011, MD2011, MD523, MD611, MMD2011, MMD2021		

loudspeakers

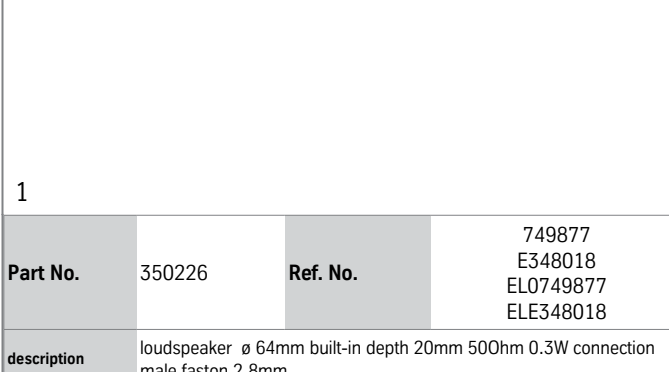
			
1			
Part No.	350226	Ref. No.	749877 E348018 EL0749877 ELE348018
description	loudspeaker \varnothing 64mm built-in depth 20mm 500hm 0.3W connection male faston 2.8mm		



contactors

ABB

power contactors



1

Part No.	380112	Ref. No.	EL0523895
description	power contactor resistive load 45A 230VAC (AC3/400V) 26A/11kW main contacts 3NO auxiliary contacts 1NO connection screw connection type A26-30-10		
accessories for	380112		
	Part No.	381031	Ref. No. —
	auxiliary contact contacts 1NO/1NC AC1 16A AC15 3A connection screw connection for contactors B6/B7/VB7		

1

Part No.	381547	Ref. No.	5239090 E324044 EL0510675 EL0523909 ELE324044
description	power contactor resistive load 25A 100-250VAC (AC3/400V) 9A/4kW main contacts 3NO auxiliary contacts 1NO connection screw connection type AF09-30-10-13		

ISKRA (FANAL)

power contactors



1

Part No.	380211	Ref. No.	E0465 E324001 ELE324001
description	power contactor 230VAC		
For models:	1011, 2011, 611, AUTOCLEAN, GENIUS, GENIUS6-11, GENIUS6-11GAS, GENIUSGAS, JOKERB, JOKERC, MD523, MD611, MMD611		

1

	Part No.	380216	Ref. No.	E0467 E324002 ELE324002
	description	power contactor 230VAC		
	For models:	1011, 2011, 611, AUTOCLEAN, GENIUS, GENIUS6-11, MD1011, MD2011, MMD1011, MMD2011, MMD2021, MULTIMAXA, MULTIMAXB, MULTIMAXB6-11AUTOCLEAN		



1

Part No.	380306	Ref. No.	580481 E324023 EL0580481 ELE324023
description	power contactor AC3 4A		
For models:	1011, 1221, 2011, 2021, 611, AUTOCLEAN, GENIUS, GENIUS6-11, GENIUS6-11GAS, GENIUSGAS, MAKT, MB, MULTIMAXA, MULTIMAXB, MULTIMAXB6-11AUTOCLEAN		



1

Part No.	380214	Ref. No.	332682 E0470 E324004 EL0332682 ELE324004
description	power contactor resistive load 20A 230VAC (AC3/400V) 8.5A/5.5kW main contacts 3NO auxiliary contacts 1NO connection screw connection type Fanal DSL7 00 type ISKRA K07M 00		
For models:	MD1011, MD2011, MD523, MD611, MMD2011, MMD2021		



1

Part No.	380213	Ref. No.	324001 EL0324001 ELE324001
description	power contactor resistive load 20A 230VAC (AC3/400V) 8.5A/5.5kW main contacts 3NO auxiliary contacts 1NO connection screw connection type Fanal DSL7 10 type ISKRA K07M 10		
For models:	EBM3e-McDonalds, EBM5, EDC6-11, ELH101, ELH51, ELH53, ELH5-3-McDonalds, ELH61, HUD511, MD523, MD611, MMC1011, MMC611, MMD1011, MMD611		



1

Part No.	380217	Ref. No.	584150 E0487 E324009 ELE324009
description	power contactor resistive load 75A 230VAC (AC3/400V) 32A/22kW main contacts 3NO auxiliary contacts 1NO/1NC connection screw connection type Fanal DSL43 11 type ISKRA KNL43		
For models:	MD2011, MMD2011, MMD2021		



auxiliary contacts



1

Part No.	380225	Ref. No.	332690 E0471 E324005 EL0873683 ELE324005
description	auxiliary contact contacts 3NO/1NC AC15 6A for contactors K03C/ K07C connection screw connection type Fanal SC4 31 type ISKRA ND4C 31		
For models:	MD1011, MD2011, MD523, MD611, MMD2011, MMD2021		

CRYDOM



1

Part No.	402052	Ref. No.	EL0752665 ELE324032
description	solid state relay CRYDOM 1 phase 90A 600V 4-32VDC L 58.6mm W 45mm screw type H12WD4890PG		

TELEMECANIQUE (Schneider Electric)

auxiliary contacts



1

Part No.	380987	Ref. No.	751790 E324038 EL0751790 ELE324038
description	auxiliary contact contacts 3NO/1NC AC15 10A for contactors LC1K connection screw type LA1KN31		
For models:	1011, 1221, 2011, 2021, 611, AUTOCLEAN, GENIUS, GENIUS6-11, MAKT, MB, MULTIMAXB, MULTIMAXB6-11AUTOCLEAN		

relays

time relays

time relays



1

Part No.	381009	Ref. No.	780421 E332013 EL0780421 ELE332013
description	time relay ABB CT-AHE time range 0.3-30s 220-240VAC 4A		
For models:	1011, 2011, 611, EB30, EB30XLDIGITAL, GENIUS, MAKT, MB		

solid state relays

CELDUC



1

Part No.	402049	Ref. No.	752401 E324033 EL0752401 ELE324033
description	solid state relay CELDUC 1 phase 60A 24-600V 3-32VDC L 58mm W 45mm screw type S0965460		
For models:	1011, 2011, 611, AUTOCLEAN, GENIUS, GENIUS6-11, GENIUS6-11GAS, GENIUSGAS, MAKT, MB, MULTIMAXA, MULTIMAXB		
accessories for	402049		
	Part No.	401564	Ref. No. —
heat-conducting foil L 62mm W 45mm for solid state relay			



1

Part No.	380288	Ref. No.	332615 E0237 E332002 EL0332615 ELE332002
description	time relay ELEKTRON VZE 806 time range 60s 24-250 AC/DC 5A connection cable mounting measurements DIN railmm		
For models:	MD1011, MD2011, MD523, MD611, MMD2011, MMD2021		



1

Part No.	350151	Ref. No.	767344 E320080 EL0767344 ELE320080
description	time relay FIBER 5A clock generator 230V voltage AC time range T1 4min T2 10s		



1

Part No.	402051	Ref. No.	742775 E310031 EL0742775 ELE310031
description	transformer primary 230VAC secondary 16.5VAC 2x15VA connection male faston 50/60Hz		
For models:	1011, 1221, 2011, 2021, 611, AUTOCLEAN, GENIUS, GENIUS6-11, GENIUS6-11GAS, GENIUSGAS, MAKT, MB, MULTIMAXA, MULTIMAXB, MULTIMAXB6-11AUTOCLEAN		

transformers

encapsulated transformers

multiple connections



1

Part No.	400252	Ref. No.	570443 E310024 EL0570443 ELE310024
description	transformer		
For models:	2011, 2021, AUTOCLEAN, GENIUS, GENIUSGAS, MULTIMAXA, MULTIMAXB		



1

Part No.	400251	Ref. No.	572217 E310021 EL0572217 ELE310021
description	transformer 44VA		
For models:	1011, 1221, 2021, 611, AUTOCLEAN, EB30, EB30XLDIGITAL, GENIUS, GENIUS6-11, GENIUS6-11GAS, GENIUSGAS, JOKERB, JOKERC, MAKT, MB, MULTIMAXA, MULTIMAXB		

PMA



1

Part No.	379054	Ref. No.	P0264
description	transformer primary 230VAC secondary 12VAC 3VA secondary 0.25A H 40mm L 45mm W 50mm connection screw 50/60Hz type 153/M		

electronic controllers

SHANGFANG

accessories



1

Part No.	379054	Ref. No.	P0264
description	transformer primary 230VAC secondary 12VAC 3VA secondary 0.25A H 40mm L 45mm W 50mm connection screw 50/60Hz type 153/M		



TECNOLOGIC

universal controllers

built-in version



1

Part No.	379246	Ref. No.	329657 E0615 E336011 EL0329657 ELE336011
description	electronic controller TECNOLOGIC type TLK96HCRR--S mounting measurements 90x90mm 100-240V voltage AC Pt100/TC (J,K) relay outputs 2 CO-8A(3) CO-8A(3) Pt100/TC (J,K) front measurements 96x96mm built-in depth 60mm protection IP65 built-in version yes defr. funct. no -100 up to +1600°C display 4 digits		
For models:	MD2011		
accessories for	379246		
	Part No.	379052	Ref. No. —
	temperature probe PTC 1k0hm cable silicone probe -50 up to +150°C cable -50 up to +180°C probe ø6x40mm cable length 1.5m without screw connection 2-wire		
	Part No.	379053	Ref. No. —
	temperature probe PTC 1k0hm cable PVC probe -50 up to +150°C cable -10 up to 100°C probe ø6x30mm cable length 3m without screw connection 2-wire		

electronic thermometers

built-in version



1

Part No.	379203	Ref. No.	E348010 ELE348010 P0260
description	thermometer TECNOLOGIC K38VFC-----E---- mounting measurements 70x28mm built-in depth 64mm 12V voltage AC/DC Pt100/TC (J,K) -200 up to +1760°C display 3½ digits 1 RoomTempIN Pt100/TC (J,K) defr. funct. no front measurements 35x78.5mm		
accessories for	379203		
	Part No.	379050	Ref. No. —
	temperature probe Pt100 cable Vetrotex probe -200 up to +600°C cable -50 up to +350°C probe ø6x100mm cable length 2.7m without screw connection 3-wire		
	Part No.	379054	Ref. No. P0264
	transformer primary 230VAC secondary 12VAC 3VA secondary 0.25A H 40mm L 45mm W 50mm connection screw 50/60Hz type 153/M		

miscellaneous

universal controllers



1

Part No.	400206	Ref. No.	332143 E0432 E336010 EL0332143 ELE336010
description	electronic controller 230V TempIN1 thermocouple K (NiCr-Ni) temperature controller		
For models:	MD1011, MD2011, MD523, MD611, MMD2011, MMD2021		

probes

universal probes

temperature probes



1

Part No.	379062	Ref. No.	E316009 ELE316009 P0268
description	temperature probe thermocouple J (Fe-CuNi) cable Vetrotex probe -50 up to +750°C cable -50 up to +350°C probe ø6x50mm cable length 3m without screw connection 2-wire		

producer-specific probes

probes



1

Part No.	379117	Ref. No.	316016 873241 E316016 EL0873241
description	core temperature probe Pt100 cable PVC probe -100 up to 450°C cable -10 up to 100°C connection male faston 6.3mm thread 1/4" probe ø4x82mm cable length 1.4m		



1

Part No.	379088	Ref. No.	E0431
description	temperature probe Pt100 cable silicone probe -100 up to 450°C cable -50 up to +180°C connection 2-wire thread probe ø3.2x28mm cable length 1.1m		
For models:	MD2011, MMD2011, MMD2021		



			
Part No.	379087	Ref. No.	E0436 E316004 EL0570621 ELE316004 ELO570621
description	temperature probe thermocouple K (NiCr-Ni) cable silicone probe -50 up to 1150°C cable -50 up to +180°C connection male faston 2.8mm thread probe ø1x30mm cable length 1.6m		
For models:	1011, 1221, 2011, 2021, 611, AUTOCLEAN, GENIUS, GENIUS6-11, GENIUS6-11GAS, GENIUSGAS, JOKERB, JOKERC, MD2011, MMD2021, MULTIMAXA, MULTIMAXB, WU14		

			
Part No.	379086	Ref. No.	E0433 E316003 ELE316003
description	temperature probe thermocouple K (NiCr-Ni) cable silicone probe -50 up to 1150°C cable -50 up to +180°C connection male faston thread probe ø1x30mm cable length 1.2m		
For models:	MD1011, MD2011, MD523, MD611, MMD1011, MMD2011, MMD611		

core probes





Part No.	378358	Ref. No.	747017 EL0747017
description	core temperature probe		

			
Part No.	379592 ¹	Ref. No.	752363 E316024 EL0752363 ELE316024
description	core temperature probe 3 point probe cable PTFE probe -40 up to +250°C cable -40 up to +250°C connection 5-wire probe ø4x100mm thread cable length 4.5m handle ø 12mm handle length 85mm		
For models:	1011, 1221, 2011, 2021, 611, AUTOCLEAN, GENIUS, GENIUS6-11, GENIUS6-11GAS, GENIUSGAS, MAKT, MB, MULTIMAXA, MULTIMAXB		

¹ multipoint probe

			
Part No.	379692	Ref. No.	783668 E316026 EL0783668 ELE316026
description	core temperature probe Pt100 cable PTFE probe -40 up to +250°C cable -40 up to +250°C connection 2-wire probe ø4x82mm thread 1/4" cable length 1.8m handle ø 12mm handle length 90mm		

			
Part No.	379116	Ref. No.	316015 E316027 ELE316027
description	core temperature probe Pt100 cable PTFE probe -40 up to +250°C cable -40 up to +250°C connection 2-wire probe ø4x82mm thread 1/4" cable length 3m handle ø 12mm handle length 90mm		
For models:	EDC6-11		

			
Part No.	379089	Ref. No.	E316010 ELE316010 V0602
description	core temperature probe Pt100 cable SS corrugated hose probe -40 up to +250°C cable -40 up to +250°C connection 3-wire probe ø4x100mm thread cable length 1.9m handle ø 15mm handle length 85mm		
For models:	MD2011, MMD1011, MMD2011, MMD2021, MMD611		

electronics

frequency converters

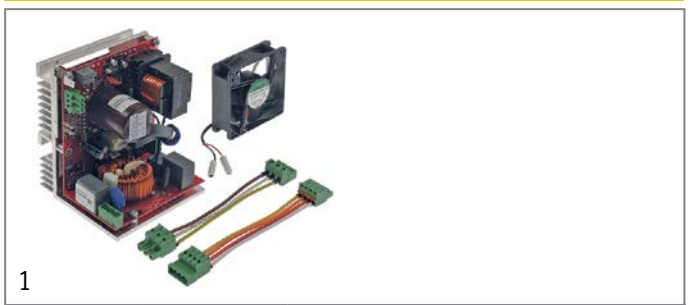

Part No.	403178	Ref. No.	EL0508588 EL0779393 EL2002608
description	frequency converter kit motor control 230V 50/60 L 135mm W 110mm H 135mm		

rectifiers



Part No.	400253	Ref. No.	570532 E308056 EL0570532 ELE308056
description	rectifier		
For models:	1011, 1221, 2011, 2021, 611, AUTOCLEAN, EB30, EB30XLDIGITAL, GENIUS, GENIUS6-11, GENIUS6-11GAS, GENIUSGAS, JOKERB, JOKERC, MAKT, MB, MULTIMAXB, MULTIMAXB6-11AUTOCLEAN		



PCBs



1

Part No.	403181	Ref. No.	742457 EL0502031 EL0742457
description	conversion kit combi-steamer Genius T 6-11 10-11 L 155mm W 115mm cable length 60mm display with PCB		
For models:	1011, 1221, 2011, 2021, 611, AUTOCLEAN, GENIUS, GENIUS6-11, GENIUS6-11GAS, GENIUSGAS, MULTIMAXB		



1

Part No.	402619	Ref. No.	742465 E340053 EL0742465 ELE340053
description	keypad PCB combi-steamer 1121/2021 L 350mm W 121mm with display		
For models:	1011, 1221, 2011, 2021, 611, AUTOCLEAN, GENIUS, MB, MULTIMAXB, MULTIMAXB6-11AUTOCLEAN		



1

Part No.	401000	Ref. No.	580740 E340040 EL0580740 ELE340040
description	keypad PCB suitable for ELOMA with display		
For models:	EDC6-11		



1

Part No.	401937	Ref. No.	344010 EL0344010
description	main PCB		
For models:	MMC1011, MMC611, MMD1011, MMD611		



1

Part No.	400013	Ref. No.	E0510 E344002 ELE344002
description	PCB combi-steamer 6x1/1 5x2/3 level control		



1

Part No.	403179	Ref. No.	EL0791458
description	PCB combi-steamer Genius T 6-11 10-11 L 400mm W 155mm		



1

Part No.	400015	Ref. No.	332704 E0506 E332009 EL0332704 ELE332009
description	PCB combi-steamer MD 1011 without mounting angle pulse timer for steaming		
For models:	MD1011, MD2011, MD523, MD611, MMD2011, MMD2021		



1

Part No.	400016	Ref. No.	593648 E0505 E332008 EL0593648 ELE332008
description	PCB pulse timer for steaming with mounting angle		



solenoid valves

solenoid valves (water)

INTERELEKTRIK

medium temperature: 90°C 90°C 60°C
 ambient temperature: 60°C 25°C 60°C
 duty cycle: 40% 100% 100%



1

Part No.	370688	Ref. No.	754463 EL0754463
description	solenoid valve 220-240VAC inlet 3/4" outlet 13.5mm DN8 t.max. 90°C plastic		
For models:	1011, 1221, 2011, 2021, 611, GENIUS, MAKT, MB		

MÜLLER

medium temperature: 90°C
 duty cycle: 100%

spare parts and accessories

filters



1

Part No.	371122	Ref. No.	0249688 418017 EL0249688 H0421
description	solenoid valve filter ø 19mm H 10mm suitable for MÜLLER		
For models:	1011, 1221, 2011, 2021, 611, EB30, EB30XLDIGITAL, EBM5, EDC6-11, ELH101, ELH51, ELH53, ELH61, GENIUS, MAKT, MB, MD1011, MD2011, MD523, MD611, MMC1011, MMC1011G, MMC2011, MMC2021, MMC611, MMD1011, MMD1011G, MMD2011, MMD2021, MMD611		

RPE

JOHN GUEST



1

Part No.	374113	Ref. No.	EL0508945 EL0508982
description	solenoid valve triple straight inlet 3/4" outlet 10mm output 0.07-0.14l/min t.max. 60°C RPE		

solenoid valves with reducers

2-fold



1

Part No.	374102 ¹	Ref. No.	EL0508944 EL0508981
description	solenoid valve double straight 220-240VAC inlet 3/4" outlet 10mm input 10l/min DN10 RPE output B 0.32-0.42l/min		

¹cylindrical outlet

3-fold

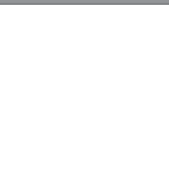

1

Part No.	374113	Ref. No.	EL0508945 EL0508982
description	solenoid valve triple straight inlet 3/4" outlet 10mm output 0.07-0.14l/min t.max. 60°C RPE		

metal



M&M

2-way

D-265/266 series



1

Part No.	370041	Ref. No.	436003 E0150 ELE436003	
description	solenoid valve 2-ways 230VAC connection 3/8" L 54mm DN 10.5mm slide-on receptacle DIN -10 up to 130°C M&M type series D-265/266 coil type 7700 membranes FKM (water) p max 16bar			
spare parts for	370041			
	Part No.	371026	Ref. No.	—
	solenoid coil M&M 230VAC 18VA 50Hz coil type 7700 seat ø 15mm			
accessories for	370041			
	Part No.	371090	Ref. No.	—
	power socket plug type DIN 43650A screw			



MÜLLER			
2-way			
			
1			
Part No.	370069 ¹	Ref. No.	024775 374806 436004 436007 436033 436039 436040 754471 E0153 E0157 E436004 E436007 E436033 E436039 EL0024775 EL0374806 EL0436040 EL0754471 ELE436004 ELE436007 ELE436033 ELE436039
description	solenoid valve 2-ways 230VAC inlet 1/8" IT outlet 1/8" IT L 30mm water MÜLLER DN10		
For models:	1011, 1221, 2011, 2021, 611, AUTOCLEAN, EB30, EB30XLDIGITAL, EBM3e-McDonalds, EBM5, EDC6-11, ELH101, ELH51, ELH53, ELH61, GENIUS, GENIUSGAS, MAKT, MB, MD1011, MD2011, MD523, MD611, MMC1011, MMC1011G, MMC2011, MMC2021, MMC611, MMD1011, MMD1011G, MMD2011, MMD2021, MMD611, MULTIMAXB		

¹with adjusting screw

			
1			
Part No.	370037 ¹	Ref. No.	E0155
description	solenoid valve 2-ways 230VAC inlet 1/8" IT outlet M16x1 outer steam MÜLLER		

¹with adjusting screw

Solenoid valve - accessories

filters

			
1			
Part No.	371122	Ref. No.	0249688 418017 EL0249688 H0421
description	solenoid valve filter ø 19mm H 10mm suitable for MÜLLER		
For models:	1011, 1221, 2011, 2021, 611, EB30, EB30XLDIGITAL, EBM5, EDC6-11, ELH101, ELH51, ELH53, ELH61, GENIUS, MAKT, MB, MD1011, MD2011, MD523, MD611, MMC1011, MMC1011G, MMC2011, MMC2021, MMC611, MMD1011, MMD1011G, MMD2011, MMD2021, MMD611		

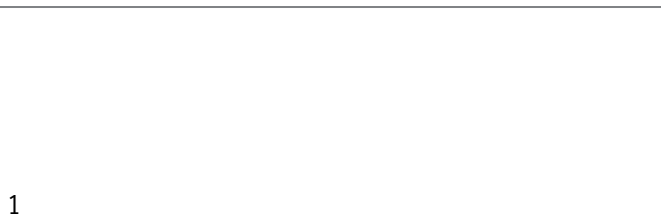
			
1			
Part No.	370863	Ref. No.	502733 889555 EL0502733 EL0508595
description	bracket thread 3/4" for solenoid valve L 100mm brass		

pressure switches

for coffee machines

ø 45mm

			
1			
Part No.	541015	Ref. No.	E0159 E434001 ELE434001
description	pressure control ø 45mm pressure range 400/360mbar pressure range 0.4/0.36bar p max 1.02bar pressure connection vertical coffee machine parts connection 1/4" 1CO suitable for Palux, Bremer pressure connection 1/4"		



for steam control



1

Part No.	541015	Ref. No.	E0159 E434001 ELE434001
description	pressure control \varnothing 45mm pressure range 400/360mbar pressure range 0.4/0.36bar p max 1.02bar pressure connection vertical coffee machine parts connection 1/4" 1CO suitable for Palux, Bremer pressure connection 1/4"		

for combi-steamers



1

Part No.	541526	Ref. No.	772305 784028 E320083 EL0784028 ELE320083
description	pressure control p max 0.5bar pressure connection 1/8"		
For models:	1011, 1221, 2011, 2021, 611, AUTOCLEAN, GENIUS, GENIUS6-11, GENIUS6-11GAS, GENIUSGAS, MAKT, MB, MULTIMAXB		

fans

axial fans

ebm-papst



1

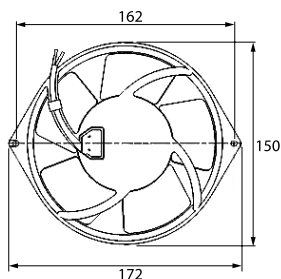



Part No.	601806 ¹	Ref. No.	0503226 EL0503226
description	axial fan L 172mm W 150mm H 55mm 230VAC 50/60Hz 45/39W bearing ball bearing connection cable 300mm manuf. no. W2S130-AB03-15 ebm-papst		

¹with ball bearings

import



1

Part No.	601080 ¹	Ref. No.	693456 E390024 EL0693456 ELE390024
description	axial fan L 119mm W 119mm H 38mm 230VAC 50/60Hz 23/20W bearing ball bearing connection male faston 2.8mm metal ADDA fan wheel \varnothing 110mm temp.-resist. 70°C		
For models:	1011, 2011, 611, EB30, EB30XLDIGITAL, GENIUS, JOKERB, JOKERC, MAKT, MB		
accessories for	601080		
	Part No.	550898	Ref. No. —
	connecting cable cable length 2000mm connection F 2.8 connection distance 7.9mm for axial flow fan		
	Part No.	692519	Ref. No. —
	guard L 120mm W 120mm plastic		

¹with ball bearings

cross flow fans

COPREL

with standard coil



1

Part No.	601032	Ref. No.	573469 E390023 EL0573469 ELE390023
description	cross flow fan COPREL TFL(FN) roller \varnothing 60mm roller length 180mm laminated core thickness 15mm motor position left 230V/50Hz 19W bearing rubber connection male faston 6.3mm coil type airflow 107m ³ /h -10 up to +60°C refrigeration		
For models:	1221, 2011, AUTOCLEAN, GENIUS, GENIUSGAS, MULTIMAXA, MULTIMAXB		

1

Part No.	601452	Ref. No.	573469
description	cross flow fan TFL 180 roller ø 60mm roller length 180mm laminated core thickness 20mm motor position left 230V/50Hz 19W universal bearing silicone connection male faston 6.3mm airflow 100m ³ /h -30 up to +100°C 230V 50Hz		
For models:	1011, 1221, 2011, 2021, 611, GENIUS, MAKT, MB		



1

Part No.	500102	Ref. No.	332410 E390019 EL0332410 ELE390019 M0155
description	fan motor 230-240V 1 phase 50Hz 0.09kW 1390rpm speeds 1 L1 150mm L2 32mm L3 27mm ø 125mm M10R IT 1.1A suitable capacitor 4µF/400V power input 200W at 50Hz 1390rpm type L7yzw4B-207 no. X5 D1 ø 17mm D2 ø 14mm		
For models:	MD1011, MD611, MMD1011, MMD611		

hot air motors





1

Part No.	510675	Ref. No.	373621 E412037 EL0373621 ELE412037
description	counterflange for fan motor ED ø 60mm int. ø 2 30mm thickness 5mm stainless steel		
For models:	1011, 1221, 2011, 2021, 611, AUTOCLEAN, GENIUS, GENIUS6-11, GENIUS6-11GAS, GENIUSGAS, MAKT, MB, MULTIMAXA, MULTIMAXB		



1

Part No.	601474	Ref. No.	693286 E390033 EL0693286 ELE390033	
description	fan motor 230V 1 phase 50/60Hz 0.03kW 3600rpm speeds 1 L1 115mm L2 20mm L3 32mm ø 12mm shaft flat length 23mm 7.5/8 0.35/0.56A suitable capacitor 3µF400V power input 75/125W at 50Hz 3600rpm type L5ow2B-317 no. W9			
For models:	EB30, EB30XLDIGITAL, JOKERB, JOKERC			
accessories for	601474			
	Part No.	602166	Ref. No.	0693375 E392020 EL0693375 ELE392020
	fan wheel blades 9 D1 ø 175mm D2 ø 8mm D3 ø 8mm H1 30mm H2 28mm ED 6-23			



1

Part No.	500171	Ref. No.	E390012 ELE390012 M0129
description	fan motor		
For models:	MD1011, MD2011, MMD1011, MMD2011, MMD2021		



1

Part No.	500172	Ref. No.	E390053 ELE390053
description	fan motor 220-240/380-415V 3 phase 50Hz 1kW 1400rpm speeds 1 L1 220mm L2 34mm L3 31mm M12R IT 4.5/2.6A power input 1350W at 50Hz 1400rpm type L9FGw4D-363 no. N7 D1 ø 23mm D2 ø 20mm		



1

Part No.	601871	Ref. No.	302821 EL0302821 EL302821
description	fan motor 230V 1 phase 50Hz 85kW 2400rpm speeds 1 L1 85mm L2 40mm L3 33mm L4 133.5mm fan wheel ø 180mm at 50Hz 230V at 60Hz 230V at 50Hz 2600rpm at 60Hz 2850rpm type R2E180-AU01-09		
For models:	ELH-3		



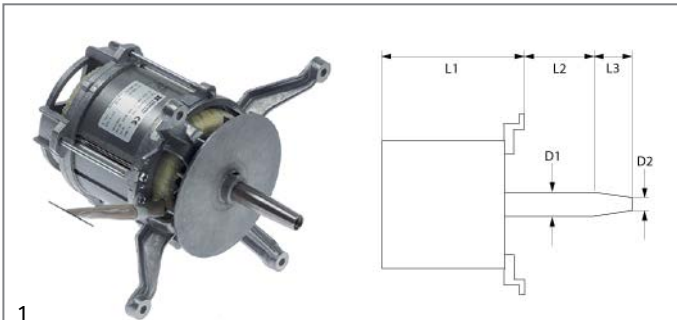

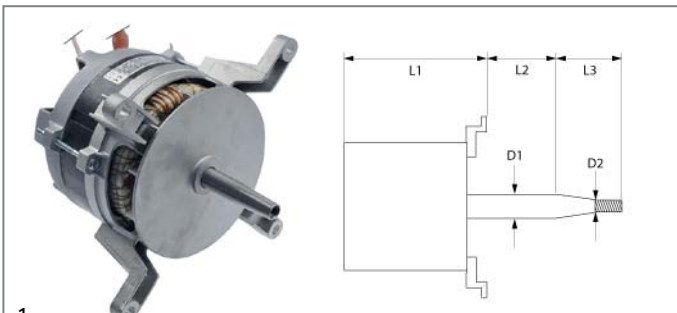
			
1			
Part No.	500170	Ref. No.	580287 E390052 EL0580287 ELE390052
description	fan motor 3 phase		

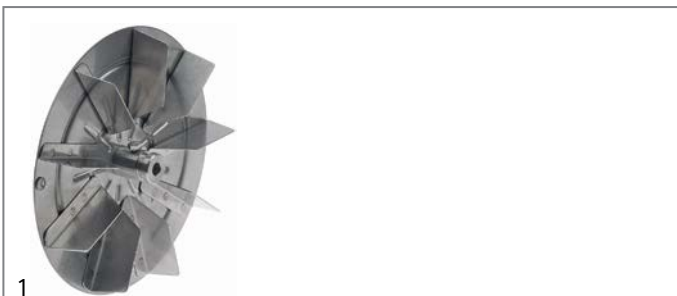
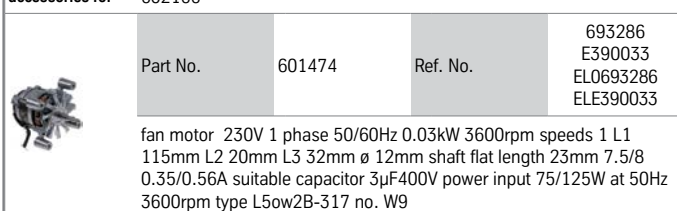

			
1			
Part No.	601864	Ref. No.	509846 742740 EL0509846
description	fan motor 380-415V 3 phase 50Hz 0.21kW 700/1400rpm speeds 2 L1 160mm L2 25mm L3 40mm D1 ø 17mm D2 ø 13mm M10R IT at 50Hz 700/1400rpm type 3081DH4052		
For models:	1011, 2011, 611, AUTOCLEAN, GENIUS, GENIUS6-11, MAKT, MB, MULTIMAXB		

			
1			
Part No.	602166	Ref. No.	0693375 E392020 EL0693375 ELE392020
description	fan wheel blades 9 D1 ø 175mm D2 ø 8mm D3 ø 8mm H1 30mm H2 28mm ED 6-23		
For models:	JOKERB, JOKERC		
accessories for	602166		
			
Part No.	601474	Ref. No.	693286 E390033 EL0693286 ELE390033
description	fan motor 230V 1 phase 50/60Hz 0.03kW 3600rpm speeds 1 L1 115mm L2 20mm L3 32mm ø 12mm shaft flat length 23mm 7.5/8 0.35/0.56A suitable capacitor 3µF400V power input 75/125W at 50Hz 3600rpm type L5ow2B-317 no. W9		

			
1			
Part No.	602168	Ref. No.	E390077 EL0899992 ELE390077
description	fan wheel for motor cooling ED ø 180mm H 20mm ID ø 25mm		
For models:	1011, 1221, 2011, 2021, 611, AUTOCLEAN, GENIUS, GENIUS6-11, GENIUS6-11GAS, GENIUSGAS, MULTIMAXA, MULTIMAXB		

			
1			
Part No.	510673	Ref. No.	580600 E412089 EL0580600 ELE412089
description	flange for fan motor ED ø 60mm int. ø 1 43mm int. ø 2 29mm thickness 6mm stainless steel		
For models:	1011, 1221, 2011, 2021, 611, AUTOCLEAN, GENIUS, GENIUS6-11, GENIUS6-11GAS, GENIUSGAS, MAKT, MB, MULTIMAXA, MULTIMAXB		

			
1			
Part No.	503149	Ref. No.	E427010 ELE427010 H0312
description	gasket fibre for fan motor ID ø 32mm ED ø 60mm thickness 1mm with 4 screw holes		
For models:	MD1011, MD2011, MD523, MD611, MMD1011, MMD2011, MMD2021, MMD611		

			
1			
Part No.	500106	Ref. No.	E390006 ELE390006 M0120
description	hot air fan 230V 1 phase 50Hz 0.12kW 2600rpm speeds 1 L1 100mm L2 34mm L3 33mm L4 178mm power input 115W 0.51A fan wheel ø 180mm at 50Hz 230V at 60Hz 230V at 50Hz 2600rpm at 60Hz 2850rpm suitable capacitor 3µF400V type R2E180-AH05-06		
For models:	MD523		
accessories for	500106		
			
Part No.	100021	Ref. No.	—
description	female faston size 2.8x0.8mm 0.5-1.0mm ² CuZn t.max. 125°C Qty 20 pcs		
			
Part No.	365028	Ref. No.	—
description	operating capacitor capacity 3µF 450V tolerance 5% 50/60Hz ambient temperature max. -25 to +85°C ø 35.5mm L 75mm M8 plastic connection male faston 6.3mm protection		



1 

Part No.	694997	Ref. No.	782939 E316025 EL0782939 ELE316025
description	speed sensor for hot air motors cable length 450mm		
For models:	1011, 1221, 2011, 2021, 611, AUTOCLEAN, GENIUS, GENIUS6-11, GENIUS6-11GAS, GENIUSGAS, MAKT, MB, MULTIMAXA, MULTIMAXB		

hot air fans

ebm-papst

1 

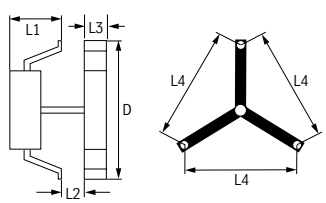

Part No.	601059	Ref. No.	E390021 ELE390021 W0320
description	hot air fan 220-230V 36W 0.26A L1 60mm L2 10mm L3 20mm L4 87mm fan wheel ø 150mm type R2K150-AN27-17 ebm-papst		

motors

gear motors

for drink dispensers

1 

Part No.	499156	Ref. No.	781894
description	gear motor FIBER type G025J0BCD86 230V 50/60Hz 4rpm shaft ø 5x6mm L 15mm motor type M51BJ0R6400		
For models:	EB30, EB30XLDIGITAL		

for combi-steamers

1 

Part No.	502293	Ref. No.	2002236 EL2002236
description	gear motor SYNCHRONOUS MOTOR type 60SM60-63-S 14W 230V voltage AC 50/60Hz 20/40rpm shaft ø 6x5mm L 82mm W 60mm H 60mm kit		

pumps

vibration pumps

1 

Part No.	499010	Ref. No.	501313 772550 E434022 EL0501313 EL0772550 ELE434022
description	vibration pump type E512/B46 230V 60W 50/60Hz inlet ø 7 outlet ø 1/8" IT CEME L 125mm		
For models:	1011, 1221, 2011, 2021, 611, AUTOCLEAN, GENIUS, GENIUS6-11, GENIUS6-11GAS, GENIUSGAS, MB, MULTIMAXA, MULTIMAXB		

condensators & interference suppression filters

operating capacitors

metal

1 

Part No.	365191	Ref. No.	EL0693480 ELE308035
description	operating capacitor capacity 3µF 400V tolerance 5% 60Hz ambient temperature max. -40 up to +85°C ø 30mm L 85mm M8 aluminium connection cable 400mm MLR25L40303063		





			
1			
Part No.	365002	Ref. No.	292753 E0454 E308007 EL0292753 ELE308007
description	operating capacitor capacity 4µF 400V tolerance 5% 50/60Hz ambient temperature max. -25 to +85°C ø 30mm L 75mm with cable MB aluminium connection cable 300mm MKP protection IP65		
For models:	MD611, MMD611		

fuses

fine fuses

			
1			
Part No.	358532	Ref. No.	190756 E0173 E375007 EL0190756 ELE375007
description	fine fuse size ø5x20mm 2A fast-acting rated 250V Qty 10 pcs		
For models:	1011, 1221, 2011, 2021, 611, AUTOCLEAN, GENIUS, GENIUS6-11, GENIUS6-11GAS, GENIUSGAS, JOKERC, MAKT, MB, MD1011, MD2011, MD611, MMD1011, MMD2011, MMD2021, MMD611, MULTIMAXA, MULTIMAXB		

			
1			
Part No.	358699	Ref. No.	572047 E0168 E375004 EL0572047 ELE375004
description	fine fuse size ø5x20mm 10A medium lag rated 250V Qty 10 pcs		
For models:	JOKERC, MD2011, MMD1011, MMD2011, MMD2021, MMD611, WU14		

			
1			
Part No.	358697	Ref. No.	E0167 E375003 ELE375003
description	fine fuse size ø5x20mm 6.3A medium lag rated 250V Qty 10 pcs		

			
1			
Part No.	358608	Ref. No.	578975 EL0578975
description	fine fuse size ø5x20mm 10A slow-acting rated 250V Qty 10 pcs		
For models:	1011, 1221, 2011, 2021, 611, GENIUS, MAKT, MB		

fine fuse holders

			
1			
Part No.	358049	Ref. No.	751847 E0965 E373028 EL0751847 ELE373028
description	fuse holder		
For models:	1221, 2011, 2021, AUTOCLEAN, GENIUS, MAKT, MB, MD2011, MMD2011, MMD2021, MULTIMAXA, MULTIMAXB		

			
1			
Part No.	550105	Ref. No.	326941 E0345 E373009 EL0326941 ELE373009
description	rail-mounted terminal WIELAND type WK10/SIU 5X20 /V0 suitable fuse ø5x20mm 1.0-16mm² 10A rated 250V		
For models:	1011, 1221, 2011, 2021, 611, AUTOCLEAN, GENIUS, GENIUS6-11, GENIUS6-11GAS, GENIUSGAS, JOKERB, JOKERC, MAKT, MB, MD1011, MD2011, MD611, MMD2011, MMD2021, MULTIMAXA, MULTIMAXB, MULTIMAXB6-11AUTOCLEAN, WU14		

screw locks

D0-system (NEOZED)

			
1			
Part No.	358043	Ref. No.	658294 E0974 E375015 EL0658294 ELE375015
description	fuse size D01 16A rated 250/400V E14 ø 11mm L 36mm Qty 10 pcs		
For models:	1221, 2021, AUTOCLEAN, GENIUS, MB, MD2011, MMD2011, MMD2021, MULTIMAXB		





 <p>1</p>			
Part No.	358045	Ref. No.	751863 E0970 E375013 EL0751863 ELE375013
description	fuse size D02 35A rated 250/400V E18 ø 15mm L 36mm Qty 10 pcs		
For models:	2011, AUTOCLEAN, GENIUS, MAKT, MB, MD2011, MMD2011, MMD2021, MULTIMAXA, MULTIMAXB		

 <p>1</p>			
Part No.	358046	Ref. No.	658286 E0969 E375012 EL0658286 ELE375012
description	fuse size D02 50A rated 250/400V E18 ø 15mm L 36mm Qty 10 pcs		
For models:	1221, 2021, AUTOCLEAN, GENIUS, MB, MD2011, MMD2011, MMD2021, MULTIMAXB		

gauge pieces (NEOZED)

 <p>1</p>			
Part No.	358064	Ref. No.	658308 E0976 E373023 EL0658308
description	gauge piece size D02 suitable for 16A		
For models:	1221, 2021, AUTOCLEAN, GENIUS, MB, MD2011, MMD2011, MMD2021, MULTIMAXB		

 <p>1</p>			
Part No.	358067	Ref. No.	751855 E0972 E373021 EL0751855 ELE373021
description	gauge piece size D02 suitable for 35A		
For models:	2011, AUTOCLEAN, GENIUS, MAKT, MB, MD2011, MMD2011, MMD2021, MULTIMAXA, MULTIMAXB		

 <p>1</p>			
Part No.	358068	Ref. No.	658278 E0971 E373020 ELE373020
description	gauge piece size D02 suitable for 50A		
For models:	1221, 2021, AUTOCLEAN, GENIUS, MB, MD2011, MMD2011, MMD2021, MULTIMAXB		

electric accessories

terminals

rail-mounted terminals

WIELAND

fuse terminal blocks

 <p>1</p>			
Part No.	550105	Ref. No.	326941 E0345 E373009 EL0326941 ELE373009
description	rail-mounted terminal WIELAND type WK10/SIU 5X20 /V0 suitable fuse ø5x20mm 1.0-16mm² 10A rated 250V		
For models:	1011, 1221, 2011, 2021, 611, AUTOCLEAN, GENIUS, GENIUS6-11, GENIUS6-11GAS, GENIUSGAS, JOKERB, JOKERC, MAKT, MB, MD1011, MD2011, MD611, MMD2011, MMD2021, MULTIMAXA, MULTIMAXB, MULTIMAXB6-11AUTOCLEAN, WU14		

accessories

 <p>1</p>			
Part No.	550337	Ref. No.	327514 E0346 E371009 EL0327514 ELE371009
description	end barrier for fuse terminal clampsmm²		
For models:	1011, 1221, 2011, 2021, 611, AUTOCLEAN, EB30, EB30XLDIGITAL, GENIUS, GENIUS6-11, GENIUS6-11GAS, GENIUSGAS, JOKERB, JOKERC, MAKT, MB, MD1011, MD2011, MD611, MMD2011, MMD2021, MULTIMAXA, MULTIMAXB, MULTIMAXB6-11AUTOCLEAN, WU14		



gas valves and ignition boxes

gas control valves

HONEYWELL



1

Part No.	106206	Ref. No.	744050 E434020 EL0744050 ELE434020
description	gas valve type VK4115V 220-240V 50/60Hz gas inlet flange 32x32mm gas outlet flange 32x32mm thermocouple connection pilot connection pressure range 15-60mbar max 60mbar operator type HONEYWELL flange 32x32mm		
For models:	1011, 1221, 2011, 2021, 611, AUTOCLEAN, GENIUS, GENIUS6-11GAS, GENIUSGAS		
accessories for	106206		
	Part No.	102845	Ref. No. —
	gas connection angled 1/2" flange 32x32mm hole distance 24x24mm Tandem		
	Part No.	102846	Ref. No. —
	gas connection straight 1/2" flange 32x32mm hole distance 24x24mm suitable for Tandem		

SIT

NOVASIT

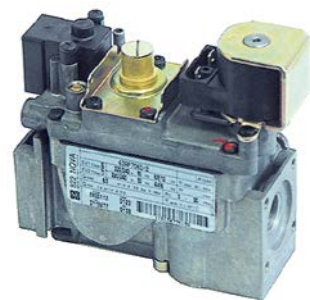

1

Part No.	101540	Ref. No.	371424 E434008 EL0371424 ELE434008 G0900
description	gas valve SIT series Novasit 822 230V 50Hz gas inlet 1/2" gas outlet 1/2" thermocouple connection pilot connection closed ignition pressure 3-5mbar pressure range 3-30mbar pressure regulator connection blind equiv. no. 0.822.113		
spare parts for	101540		
	Part No.	101313	Ref. No. —
	solenoid coil 230V 50Hz		
	Part No.	101542	Ref. No. —
	solenoid coil 50Hz NOVA 822/826/827 suitable for NOVASIT 230V		

accessories for	101540		
	Part No.	101305	Ref. No. —
	gas connection straight 1/2" flange 45x45mm ELETTROSIT/V4400/4600/4605 suitable for SIT/HONEYWELL hole distance 36x36mm		
	Part No.	101306	Ref. No. —
	gas connection angled flange 45x45mm hole distance 36x36mm 1/2" ELETTROSIT/V4400/4600/4605 screw with O-ring suitable for SIT/HONEYWELL		
	Part No.	101307	Ref. No. —
	gas connection straight flange 45x45mm hole distance 36x36mm 3/4" ELETTROSIT/V4400/4600/4605 screw with O-ring suitable for SIT/HONEYWELL		
	Part No.	101308	Ref. No. —
	gas connection angled flange 45x45mm hole distance 36x36mm 3/4" ELETTROSIT/V4400/4600/4605 screw with O-ring suitable for SIT/HONEYWELL		
	Part No.	101317	Ref. No. —
	plug with cable L 1000mm suitable for NOVASIT		
	Part No.	101503	Ref. No. —
	O-ring EPDM thickness 2mm ID ø 32mm Qty 1 pcs		
	Part No.	101924	Ref. No. —
	plug with cable L 1090mm suitable for NOVA 822/826/827		

ignition boxes

HONEYWELL



1

Part No.	101166	Ref. No.	371416 E340001 EL0371416 ELE340001 G0901
description	ignition box HONEYWELL type S4560B 1006 electrodes 1 waiting time 0s safety time 10s 220-240V 10VA 50Hz		

miscellaneous

1

Part No.	107936	Ref. No.	EL0506522
description	ignition box PACTROL suitable for ELOMA electrodes 1 waiting time 1s safety time 5s 230V 50/60Hz		





ignition parts

electrodes

 <p>1</p>			
Part No.	108151	Ref. No.	EL0507496
description	gasket igniter L 22.5mm W 15.5mm thickness 2mm graphite		

 <p>1</p>			
Part No.	699472	Ref. No.	0507495 0507997 0874833 EL0507495 EL0507997 EL0874833
description	gasket ignition electrode ID ø 13mm hole ø 6mm L 60mm W 22mm suitable for ELOMA graphite		

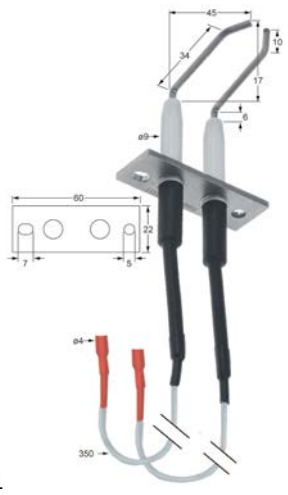
 <p>1</p>			
Part No.	107890	Ref. No.	507184 EL0507184
description	ignition electrode flange length 24mm flange width 20mm D1 ø 7mm L1 45mm L2 70mm BL1 35mm BL2 22mm connection F6.3 cable length 450mm mounting distance 9mm		

 <p>1</p>							
Part No.	106996	Ref. No.	874787 EL0874787				
description	ignition electrode flange length 60mm flange width 22mm D1 ø 9mm L1 17mm L2 45mm L3 6mm L4 34/10mm BL1 37mm BL2 32mm cable length 350mm connection ø 4mm						
For models:	1011, 2011, 611, GENIUS						
accessories for	106996						
 <table border="1"> <tr> <td>Part No.</td> <td>699472</td> <td>Ref. No.</td> <td>0507495 0507997 0874833 EL0507495 EL0507997 EL0874833</td> </tr> </table> <p>gasket ignition electrode ID ø 13mm hole ø 6mm L 60mm W 22mm suitable for ELOMA graphite</p>				Part No.	699472	Ref. No.	0507495 0507997 0874833 EL0507495 EL0507997 EL0874833
Part No.	699472	Ref. No.	0507495 0507997 0874833 EL0507495 EL0507997 EL0874833				

 <p>1</p>			
Part No.	107889	Ref. No.	5071833 EL0507183
description	ignition electrode flange length 60mm flange width 22mm D1 ø 9mm L1 33mm L2 45mm L3 6mm L4 45/7mm BL1 29mm BL2 28mm connection ø4mm cable length 350mm mounting distance 50mm		

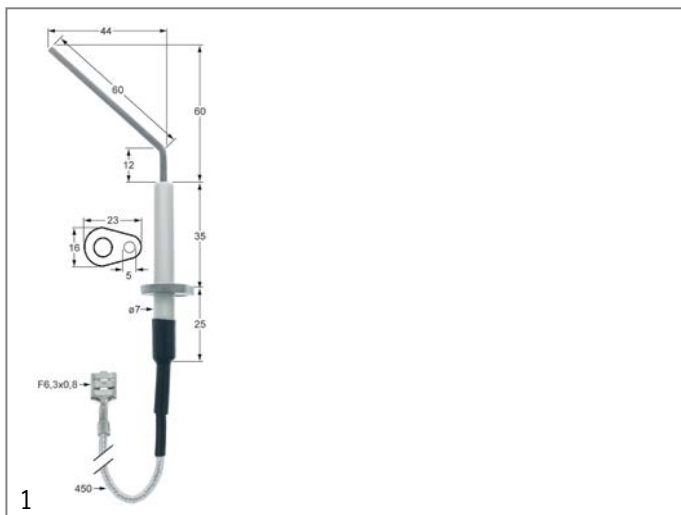

Part No.	106997	Ref. No.	874906 EL0874906
description	monitoring electrode connection \varnothing F6.3mm flange length 23mm flange width 16mm D1 \varnothing 7mm L1 60mm L2 44mm L4 12mm L3 60mm BL1 35mm BL2 25mm connection F6.3x0.8 cable length 450mm fixing dimensions \varnothing 5mm		
For models:	1011, 2011, 611, GENIUS		

ignition units



Part No.	107533	Ref. No.	EL0874892
description	ignition unit outputs 2 230VAC dimensions 85x63x38mm mounting distance 60mm inlet F2.8x0.8 outlet \varnothing 4mm type EBI4 60VA 50/60Hz secondary 15KV		

thermocouples

plug-in thermocouples

plug-in thermocouples standard

with barrel socket \varnothing 5mm - type Junkers with aluminised tip

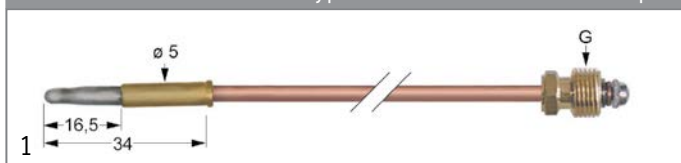

Part No.	102216	Ref. No.	E316012 ELE316012 G0686
description	thermocouple M10x1 L 1500mm plug connection \varnothing 5.0mm		

gas nozzles

pilot burner nozzles

pilot burner nozzles JUNKERS

CB 50203_/503_ series



Part No.	100222	Ref. No.	E438019 ELE438019 X0342
description	pilot burner nozzle LPG gas pressure 50mbar code 5 Qty 1 pcs suitable for JUNKERS CB50203_		

auxiliary gas parts

consumables

thread sealants



Part No.	890058	Ref. No.	593567
description	thread sealing LOCTITE 511 liquid bottle 50ml		
description	LOCTITE® 511™ - bottle 50ml It is designed for the locking and sealing of metal threaded pipes and fittings. The product cures rapidly when confined in the absence of air between close fitting metal surfaces.		
For models:	1011, 1221, 2011, 2021, 611, EB30, EB30XLDIGITAL, GENIUS, MAKT, MB		

equipment-specific units

for dough mixers

chains

connectors



Part No.	697069	Ref. No.	395021 E395021 ELE395021
description	connector single DIN/ISO 06 B-1 splitting 3/8" links 1 L 17.8mm internal width 8.8mm roller \varnothing 3mm metal		



for convection ovens/combi-steamers

1

Part No.	692909	Ref. No.	782432 EL0782432
description	bushing for door hinge H 7mm plastic D1 ø 18mm D2 ø 12mm ID ø 10mm		

1

Part No.	692910	Ref. No.	E401038 EL0563420 EL0568945
description	bushing for door hinge L 8mm ø 8mm ID ø 6mm		

injection pipes

1



Part No.	692838	Ref. No.	753793 EL0753793 ELE442262
description	injection pipe for combi-steamer straight ED ø 12mm ID ø 8mm L 180mm -		
For models:	1011, 2011, 611, GENIUS, MB		

1



Part No.	692839	Ref. No.	442263 743267
description	injection pipe for combi-steamer U-shape ED ø 12mm ID ø 10mm L 265mm		
For models:	1011, 2011, 611, AUTOCLEAN, GENIUS, GENIUS6-11, GENIUS6-11GAS, GENIUSGAS, MAKT, MB, MULTIMAXB		

cleaning system

coupling bushings

1



Part No.	501591	Ref. No.	0753890 E440154 EL0753890 ELE440154
description	hose connector stainless steel hose ø 10/13mm M9 for cleaning system combi-steamer		

cleaning arms

1



Part No.	542416	Ref. No.	0775177 E600647 EL0775177 ELE600647
description	mounting flange ø 55mm hub with gasket for wash arm suitable for ELOMA combi-steamer		

drip water trays

1



Part No.	699837	Ref. No.	783331 EL0783331 ELE474094
description	drip tray with grip fixing L 530mm W 52mm H 25mm		
For models:	1011, 611, GENIUS, MAKT, MB		

1



Part No.	699269	Ref. No.	0781177 EL0781177
description	plug H 10mm ø 20mm		

1



Part No.	699270	Ref. No.	0781185 EL0781185
description	spring L 65mm W 32.5mm H 28mm		



door mechanics

miscellaneous

1

Part No.	692909	Ref. No.	782432 EL0782432
description	bushing for door hinge H 7mm plastic D1 ø 18mm D2 ø 12mm ID ø 10mm		

1

Part No.	692910	Ref. No.	E401038 EL0563420 EL0568945
description	bushing for door hinge L 8mm ø 8mm ID ø 6mm		

door bumpers



1

Part No.	694922	Ref. No.	0886726 407079 EL0886726 ELE407079
description	rubber pad ø 11.5mm H 19mm rubber		

locking mechanism



1

Part No.	692714	Ref. No.	0791652 EL0791652
description	disc for catch ø 44mm hole ø 6x8mm		



1

Part No.	692716	Ref. No.	588504 980080 E380093 EL0588504 EL0980080 ELE380093
description	door catch with switch L 140mm W 25mm H 63mm hole distance 120mm ID ø 12mm		
For models:	JOKERB, JOKERC		



1

Part No.	692715	Ref. No.	775061 888575 EL0775061 EL0888575
description	sleeve ø 50mm L 72mm W 59mm H 31mm hole distance 60mm ID ø 37mm		
For models:	1011, 2011, 611, AUTOCLEAN, GENIUS, GENIUS6-11, GENIUS6-11GAS, GENIUSGAS, MAKT, MB, MULTIMAXA, MULTIMAXB		

accessories



1

Part No.	699836	Ref. No.	0569593 E407059 EL0569593
description	plug for door W 32mm plastic L 50mm		

vibration pumps



1

Part No.	499010	Ref. No.	501313 772550 E434022 EL0501313 EL0772550 ELE434022
description	vibration pump type E512/B46 230V 60W 50/60Hz inlet ø 7 outlet ø 1/8" IT CEME L 125mm		
For models:	1011, 1221, 2011, 2021, 611, AUTOCLEAN, GENIUS, GENIUS6-11, GENIUS6-11GAS, GENIUSGAS, MB, MULTIMAXA, MULTIMAXB		

miscellaneous

1

Part No.	696857	Ref. No.	427060 566594 EL0566594 ELE427060
description	boot L 42mm D1 ø 12mm D2 ø 36mm		
For models:	1011, 1221, 2011, 2021, 611, GENIUS, MAKT, MB		



1			
Part No.	692915	Ref. No.	E442044 EL0213500 ELE442044 H0448
description	injection pipe double L 192mm D1 ø 8mm D2 ø 6mm WS 19 hole ø 10mm		

1			
Part No.	692306	Ref. No.	213519 442042 EL0213519 ELE442042 H0446
description	pipe long D1 ø 10mm D2 ø 6mm L 134mm WS 19 thread 3/8"		
For models:	EBM5, EDC6-11, ELH101, ELH51, ELH53, ELH61, MD2011, MMC2011, MMC2021, MMD2011, MMD2021		

for pizza ovens

firebricks

1			
Part No.	850022	Ref. No.	E450029 ELE450029 P0210
description	bottom plate L 495mm W 495mm H 16mm pizza oven for ELP500		

knobs

universal knobs

1			
Part No.	110235	Ref. No.	E0322
description	knob energy regulator 1-3 t.max.°C° 50mm shaft ø 6x4.6mm shaft flat upper black		

1			
Part No.	110253	Ref. No.	301086 E0337 E365018 EL0301086 ELE365018
description	knob switch zero mark t.max.°C° 50mm shaft ø 6x4.6mm shaft flat upper black		

1			
Part No.	110241	Ref. No.	E0340 E365020 ELE365020
description	knob thermostat t.max. 110°C ø 50mm shaft ø 6x4.6mm shaft flat upper black temperature range 30-110°C		

producer-specific knobs



ELOMA

1			
Part No.	110235	Ref. No.	E0322
description	knob energy regulator 1-3 t.max.°C° 50mm shaft ø 6x4.6mm shaft flat upper black		

1			
Part No.	110253	Ref. No.	301086 E0337 E365018 EL0301086 ELE365018
description	knob switch zero mark t.max.°C° 50mm shaft ø 6x4.6mm shaft flat upper black		





			
1			
Part No.	111499	Ref. No.	332658 E0314 E365003 EL0332658 ELE365003
description	knob switch zero mark t.max.°C°C ø 52mm shaft ø 6x4mm shaft flat upper black/red		
For models:	MD1011, MD2011, MD523, MD611		

			
1			
Part No.	111498	Ref. No.	743690 E365086 EL0743690 ELE365086
description	knob t.max.°C°C ø 48mm shaft ø 6.5mm shaft flat blue		
For models:	1011, 1221, 2011, 2021, 611, AUTOCLEAN, GENIUS, MAKT, MB, MULTIMAXA, MULTIMAXB, MULTIMAXB6-11AUTOCLEAN		
accessories for	111498		
	Part No.	111510	Ref. No.
			748781 E365087 EL0748781 ELE365087
lid t.max.°C°C ø 37mm shaft ømm shaft flat silver for knob ELOMA			



			
1			
Part No.	110241	Ref. No.	E0340 E365020 ELE365020
description	knob thermostat t.max. 110°C ø 50mm shaft ø 6x4.6mm shaft flat upper black temperature range 30-110°C		

			
1			
Part No.	112877	Ref. No.	EL0504699 EL0748668
description	knob kit ø 40mm shaft ø 6.3mm		

			
1			
Part No.	111510	Ref. No.	748781 E365087 EL0748781 ELE365087
description	lid t.max.°C°C ø 37mm shaft ømm shaft flat silver for knob ELOMA		
For models:	1011, 1221, 2011, 2021, 611, AUTOCLEAN, GENIUS, GENIUS6-11, GENIUS6-11GAS, GENIUSGAS, MAKT, MB, MULTIMAXA, MULTIMAXB, MULTIMAXB6-11AUTOCLEAN		
accessories for	111510		
	Part No.	111498	Ref. No.
			743690 E365086 EL0743690 ELE365086
knob t.max.°C°C ø 48mm shaft ø 6.5mm shaft flat blue			

accessories

covers

			
1			
Part No.	111510	Ref. No.	748781 E365087 EL0748781 ELE365087
description	lid t.max.°C°C ø 37mm shaft ømm shaft flat silver for knob ELOMA		
For models:	1011, 1221, 2011, 2021, 611, AUTOCLEAN, GENIUS, GENIUS6-11, GENIUS6-11GAS, GENIUSGAS, MAKT, MB, MULTIMAXA, MULTIMAXB, MULTIMAXB6-11AUTOCLEAN		
accessories for	111510		
	Part No.	111498	Ref. No.
			743690 E365086 EL0743690 ELE365086
knob t.max.°C°C ø 48mm shaft ø 6.5mm shaft flat blue			

locks

turning lever locks

producer-specific

ELOMA/PALUX

			
1			
Part No.	699268	Ref. No.	588458 E410046 EL0588458
description	bolt L 19mm H 10mm SS		
For models:	JOKERB, JOKERC		



electromagnetic closer

 <p>1</p>			
Part No.	701439	Ref. No.	EL0503973
description	door catch 24V voltage DC L 134mm W 28mm H 40mm SS with connecting cable		
spare parts for	701439		
	Part No.	692216	Ref. No. —
	electromagnetic closer 24V voltage DC L 104mm W 24mm H 34mm series 8440		

 <p>1</p>			
Part No.	692596	Ref. No.	EL0503607
description	electromagnetic closer 24V voltage DC L 104mm W 24mm H 34mm		

handle latches

producer-specific



ELOMA

 <p>1</p>			
Part No.	692714	Ref. No.	0791652 EL0791652
description	disc for catch ø 44mm hole ø 6x8mm		

 <p>1</p>			
Part No.	694067	Ref. No.	747998 E380120 EL0747998 ELE380120
description	door catch with spigot 1-stage L 26mm total length 51mm thread M8		
For models:	1011, 2011, 611, GENIUS, GENIUS6-11, GENIUS6-11GAS, GENIUSGAS, MAKT, MB, MULTIMAXA, MULTIMAXB		

 <p>1</p>			
Part No.	694254	Ref. No.	758272 E380122 EL0758272 ELE380122
description	door catch with spigot 2-stage L 36mm total length 60mm thread M8 thread L 25mm mounting pos. hinged at left		
For models:	1011, 2011, 611, AUTOCLEAN, GENIUS, GENIUS6-11, GENIUS6-11GAS, GENIUSGAS, MAKT, MB, MULTIMAXB		

 <p>1</p>			
Part No.	694253	Ref. No.	758264 E380121 EL0758264 ELE380121
description	door catch with spigot 2-stage L 36mm total length 60mm thread M8 thread L 25mm mounting pos. hinged at right		
For models:	1011, 2011, 611, AUTOCLEAN, GENIUS, GENIUS6-11, GENIUS6-11GAS, GENIUSGAS, MAKT, MB, MULTIMAXB		

 <p>1</p>			
Part No.	692847	Ref. No.	0782505 365152 EL0782505 ELE365152
description	door handle combi-steamer hinged at left L 100mm W 55mm H 35mm handle ø 35mm blue suitable for ELOMA		
accessories for	692847		
	Part No.	692848	Ref. No. 0783382 EL0783382
	 <p>spring for door handle hinged at left combi-steamer suitable for ELOMA ED ø 15mm L 44/11mm spring thickness 1.6mm</p>		

 <p>1</p>			
Part No.	692744	Ref. No.	758388 E365106 EL0758388 ELE365106
description	door handle hinged at left blue		
For models:	1011, 611, AUTOCLEAN, GENIUS, GENIUS6-11, GENIUS6-11GAS, GENIUSGAS, MAKT, MB, MULTIMAXA, MULTIMAXB		



			
1			
Part No.	691990	Ref. No.	748765 E365091 EL0748765 ELE365091
description	door handle hinged at right L 155mm W 60mm H 58mm spring length 53mm blue mounting distance 40mm mounting thread M4		
For models:	1011, 611, AUTOCLEAN, GENIUS, GENIUS6-11, GENIUS6-11GAS, GENIUSGAS, MAKT, MB, MULTIMAXA, MULTIMAXB		
accessories for	691990		
	Part No.	111510	Ref. No. 748781 E365087 EL0748781 ELE365087
lid t.max.°C 37mm shaft ømm shaft flat silver for knob ELOMA			

			
1			
Part No.	691988	Ref. No.	749532 EL0749532
description	door handle L 155mm W 60mm H 58mm spring length 53mm blue mounting distance 40mm spring thickness 3mm		
For models:	2011, AUTOCLEAN, GENIUS, GENIUSGAS, MULTIMAXA, MULTIMAXB		
accessories for	691988		
	Part No.	111510	Ref. No. 748781 E365087 EL0748781 ELE365087
lid t.max.°C 37mm shaft ømm shaft flat silver for knob ELOMA			

			
1			
Part No.	692848	Ref. No.	0783382 EL0783382
description	spring for door handle hinged at left combi-steamer suitable for ELOMA ED ø 15mm L 44/11mm spring thickness 1.6mm		



			
1			
Part No.	692849	Ref. No.	0783390 416078 EL0783390 ELE416078
description	spring for door handle hinged at right combi-steamer suitable for ELOMA ED ø 15mm L 44/11mm spring thickness 1.6mm		

			
1			
Part No.	514450	Ref. No.	791504 EL0791504
description	spring for door handle ø 6mm L 61mm W 27.5mm		

edgemoount latches

handle latches

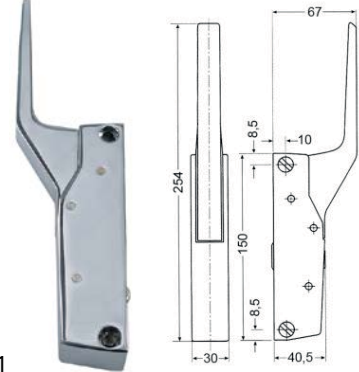
CAFF/FERMOD

			
1			
Part No.	700060	Ref. No.	377732 E380010 EL0377732 ELE380010 H0195
description	handle latch L 150mm mounting distance 133mm non lockable heated units G 791		
For models:	MD1011, MD523, MD611, MMD1011, MMD611		
accessories for	700060		
	Part No.	700061	Ref. No. 382825 382833 E380011 E380012 E598001 EL0382825 ELE380012 ELE598001 H0196 H0197 V0603
door catch L 58mm W 20mm H 35mm mounting distance 42mm chrome-plated brass for headed units			
	Part No.	700062	Ref. No. 292532 E407029 EL0292532 ELE407029 K0443
handle protection heated units			



RAHRBACH			
6188 ERGO series			
Part No.	690808	Ref. No.	565458 B0280 E380002 EL0565458
description	handle latch L 185mm mounting distance 150mm chrome-plated non lockable for headed units 6188 type ERGO		
For models:	WU14		
accessories for	690808		
	Part No.	690110	Ref. No. —
	base plate H 1mm L 38mm W 11mm mounting distance 26mm plastic		
	Part No.	690111	Ref. No. —
	base plate H 2mm L 38mm W 11mm mounting distance 26mm plastic		
	Part No.	690114	Ref. No. —
	base plate H 3.5mm L 185mm W 30mm mounting distance 150mm with inclination thread M5		
	Part No.	700082	Ref. No. —
	door catch L 38mm W 18mm mounting distance 26mm		

magnetic locks			
miscellaneous			
Part No.	701660	Ref. No.	EL0037265 EL0510585
description	magnetic lock L 56mm mounting distance 46mm white RALY-6		

door catches			
Part No.	700061	Ref. No.	382825 382833 E380011 E380012 E598001 EL0382825 ELE380012 ELE598001 H0196 H0197 V0603
description	door catch L 58mm W 20mm H 35mm mounting distance 42mm chrome-plated brass for headed units		
For models:	MD1011, MD523, MD611, MMD1011, MMD611		
accessories for	700061		
	Part No.	690414	Ref. No. —
	handle latch L 150mm mounting distance 133mm non lockable refrigeration units G 791		

walk-in fridge catches			
STUV			
3.31.015x.x series			
Part No.	700072	Ref. No.	000043 E380015 EL0000043 ELE380015 H0201
description	door catch H 17mm L 84mm W 53mm mounting distance 68mm zinc die cast with wedge heated units		
For models:	MD2011, MMD2011, MMD2021		

Part No.	700071	Ref. No.	030732 E380014 EL0030732 ELE380014 H0200
description	snap lock H 58mm L 87mm W 64mm mounting distance 68mm		
For models:	MD2011, MMD2011, MMD2021		



snap locks

producer-specific

ELOMA



1

Part No.	701303	Ref. No.	380075 587125 593516 E380046 E380072 EL0587125 EL0593516 ELE380046 ELE380072
description	door catch for convection oven L 140mm W 26mm H 65mm		
For models:	EB30, EB30XLDIGITAL, EDB 6-23		

miscellaneous

1

Part No.	701660	Ref. No.	EL0037265 EL0510585
description	magnetic lock L 56mm mounting distance 46mm white RALY-6		

hinges

edgemoount hinges

STUV



1

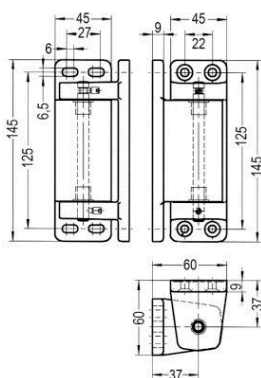

Part No.	700073	Ref. No.	000051 E382006 EL0000051 ELE382006 H0198
description	edgemoount hinge L 145mm W 45mm mounting distance 125mm hinging left/right without lift centre of rotation 37mm zinc die cast, chrome-plated refrigeration units		
For models:	MD2011, MMD2011, MMD2021		
accessories for	700073		
	Part No.	690310	Ref. No. —
base plate for 4000/4001 series thickness 5mm			

door bearing



1

Part No.	692688	Ref. No.	E382017 EL0569178
description	hinge L 78mm W 40mm H 5mm mounting distance 21mm mounting pos. lower bolt 12mm bolt ø 6mm		
For models:	JOKERB, JOKERC		



1

Part No.	692687	Ref. No.	E382016 EL0565601
description	hinge L 78mm W 40mm H 5mm mounting distance 21mm mounting pos. upper bolt 12mm bolt ø 6mm		
For models:	JOKERB, JOKERC		



1

Part No.	692689	Ref. No.	EL0502734
description	hinge repair set		

accessories

bushes

1

Part No.	692909	Ref. No.	782432 EL0782432
description	bushing for door hinge H 7mm plastic D1 ø 18mm D2 ø 12mm ID ø 10mm		

1

Part No.	692910	Ref. No.	E401038 EL0563420 EL0568945
description	bushing for door hinge L 8mm ø 8mm ID ø 6mm		



miscellaneous



1			
Part No.	694994	Ref. No.	0875023 EL0875023
description	locking disc for hinge ID ø 12mm ED ø 30mm plastic		

pullouts

rollers

rollers

accessories



1			
Part No.	560133	Ref. No.	EL0251887
description	hexagonal nut thread M6 H 5mm WS 10 SS DIN/ISO DIN 934 / ISO 4032/8673 Qty 20 pcs		

equipment feet and end caps

end caps and plugs

for square pipes



1			
Part No.	696728	Ref. No.	E407057 EL0568929
description	plug rectangular mounting measurements 31x28mm plastic		
For models:	JOKERB, JOKERC		

DERBY RUOTE

spare parts and accessories

miscellaneous



1			
Part No.	560193	Ref. No.	0349771 EL0349771
description	tooth lock washer ID ø 10.4mm ED ø 18mm zinc-coated steel DIN/ISO DIN 6798A Qty 1 pcs for thread M10		

gaskets

gaskets for heated units

window seals

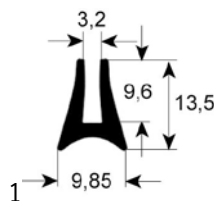

			215961 425041 E425041 EL0215961 ELE425041 H0515
Part No.	900110	Ref. No.	
description	window gasket profile 1590 Qty supplied by meter		
For models:	EBM5, ELH101, ELH51, ELH61, MD1011, MD2011, MD611, MMC1011, MMC1011G, MMC611, MMD1011, MMD1011G, MMD2011, MMD2021, MMD611		

door seals

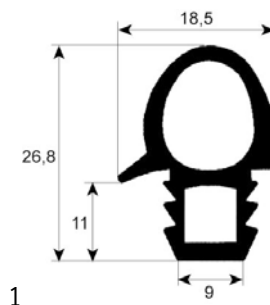

			384410 425030 E425030 EL0384410 ELE425030 H0497
Part No.	900100	Ref. No.	
description	door seal profile 2070 W 460mm L 645mm external size Qty 1 6 x 1/1		
For models:	EDC6-11, MD611, MMC611, MMD611		

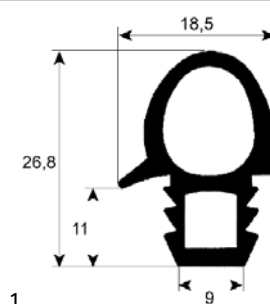

			382310 E425033 EL0382310 ELE425033 H0502
Part No.	900101	Ref. No.	
description	door seal profile 2070 W 645mm L 700mm external size Qty 1 10 x 1/1		



Part No.	900204	Ref. No.	E425056 ELE425056
description	door seal profile 2448 W 710mm L 1470mm external size Qty 1		

Part No.	900203	Ref. No.	E425090 ELE425090
description	door seal profile 2448 W 730mm L 980mm external size Qty 1		

Part No.	900865	Ref. No.	742368 E425198 EL0742368 ELE425198
description	door seal profile 2449 W 490mm L 520mm Qty 1		
For models:	611, GENIUS, GENIUS6-11, GENIUS6-11GAS, MAKT, MB, MULTIMAXB6-11AUTOCLEAN		

Part No.	901483	Ref. No.	200021 742384 E425200 EL0742384 ELE425200
description	door seal profile 2449 W 520mm L 1505mm Qty 1		
For models:	2011, GENIUS, MAKT, MB		

Part No.	900497	Ref. No.	742376 E425199 EL0742376 ELE425199
description	door seal profile 2449 W 520mm L 775mm Qty 1		
For models:	1011, GENIUS, MAKT, MB		

Part No.	901490	Ref. No.	742406 E425202 EL0742406 ELE425202
description	door seal profile 2449 W 690mm L 1550mm Qty 1		
For models:	1221, 2021, AUTOCLEAN, GENIUS, MB, MULTIMAXB		

Part No.	900498	Ref. No.	425121 425166 693219 E425166 EL0693219 ELE425166
description	door seal profile 2515 perimeter 1670mm Qty 1		
For models:	EBM3e-McDonalds, EDB 6-23, JOKERB, JOKERC		



1

Part No.	901277	Ref. No.	E425207 ELE425207
description	door seal profile 2690 L 2275mm		

1

Part No.	901821	Ref. No.	425127 E425208 ELE425208
description	door seal profile 2690 L 2920mm		

1

Part No.	902491	Ref. No.	0501645 EL0501645
description	door seal profile 2710 L 1555mm suitable for ELOMA closed		

1

Part No.	900050	Ref. No.	131385 425060 E425031 EL0131385 ELE425031 ELE425060 H0500
description	door seal profile 2710 Qty supplied by meter		
For models:	EB30, EB30XLDIGITAL, ELH61, MD1011, MD523, MD611, MMD1011, MMD611, WU14		

1

Part No.	902505	Ref. No.	2000214 EL2000214
description	door seal profile 2736 W 510mm L 1487mm outer plug size Qty 1 suitable for ELOMA 20-11		

1

Part No.	902507	Ref. No.	2000212 EL2000212
description	door seal profile 2736 W 510mm L 484mm outer plug size Qty 1 suitable for ELOMA 6-11		

1

Part No.	902504	Ref. No.	2000213 EL2000213
description	door seal profile 2736 W 510mm L 763mm outer plug size Qty 1 suitable for ELOMA 10-11		

1

Part No.	902506	Ref. No.	2000216 EL2000216
description	door seal profile 2736 W 685mm L 1535mm outer plug size Qty 1 suitable for ELOMA 20-21		

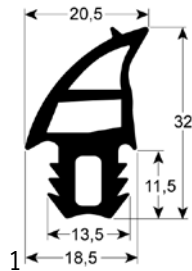

			
Part No.	902492	Ref. No.	2000215 742392 E425201 EL0742392 EL2000215 ELE425201
description	door seal profile 2736 W 695mm L 1000mm outer plug size Qty 1 suitable for ELOMA 12-21 silicone		
For models:	1221, 2021, AUTOCLEAN, GENIUS, MB, MULTIMAXB		

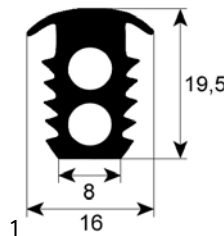
			
Part No.	901298	Ref. No.	693200 E425113 EL0693200 ELE425113
description	door seal profile 2775 Qty supplied by meter		
For models:	JOKERB, JOKERC		

gaskets for tray rack trolleys

			
Part No.	900199	Ref. No.	549207 E425062 EL0549207 ELE425062
description	tray rack trolley gasket profile 4070 L 1000mm Qty 1		
For models:	1011, 1221, 2021, 611, GENIUS, MAKT, MB		

gaskets for control panels

			
Part No.	902493	Ref. No.	0742309 E425194 EL0742309 ELE425194
description	gasket for control panel W 220mm L 890mm suitable for ELOMA for combi-steamer with 8 mounting clips		

1			
Part No.	902556	Ref. No.	EL0742295 ELE425193
description	gasket for control panel W 225mm L 635mm suitable for ELOMA for combi-steamer with 6 mounting clips		

O-rings

EPDM

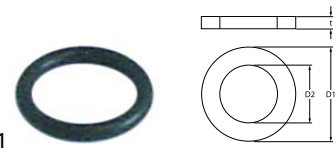
			
Part No.	504574	Ref. No.	013471 E425026 EL0013471 ELE425026 H0403
description	O-ring EPDM thickness 1.78mm ID ø 9.25mm Qty 1 pcs		
For models:	1011, 1221, 2011, 2021, 611, AUTOCLEAN, GENIUS, GENIUS6-11, GENIUS6-11GAS, GENIUSGAS, MD1011, MD2011, MD523, MD611, MMD1011, MMD2011, MMD611, MULTIMAXA, MULTIMAXB		

silicone

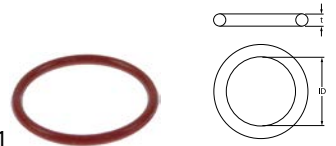
			
Part No.	532726	Ref. No.	577642 E425153 EL0577642 ELE425153
description	O-ring silicone thickness 1.5mm ID ø 17mm Qty 10 pcs		
For models:	JOKERB, JOKERC		

Viton

			
Part No.	510579	Ref. No.	581410 E425066 EL0581410 ELE425066
description	O-ring Viton thickness 2.62mm ID ø 34.6mm Qty 1 pcs		
For models:	1011, 1221, 2011, 2021, 611, AUTOCLEAN, GENIUS, GENIUS6-11, GENIUS6-11GAS, GENIUSGAS, MAKT, MB, MULTIMAXA, MULTIMAXB		



Part No.	529357	Ref. No.	753742 E425183 EL0753742 ELE425183
description	O-ring Viton thickness 3.53mm ID ø 23.4mm Qty 1 pcs		
For models:	1011, 1221, 2011, 2021, 611, AUTOCLEAN, GENIUS, GENIUS6-11, GENIUS6-11GAS, GENIUSGAS, MB, MULTIMAXB		

NBR

Part No.	532735	Ref. No.	0503932 425185 E425185 EL0503932 ELE425185
description	O-ring NBR 70 thickness 1mm ID ø 6mm		
For models:	JOKERB		

sealing washers

copper gaskets

DIN-7603-A

Part No.	528433	Ref. No.	097071 217840 E427020 E427039 EL0097071 EL0217840 EL0571849 ELE427020 ELE427039 R0300
description	flat gasket copper ED ø 14mm ID ø 10mm thickness 1mm		
For models:	1011, 1221, 2011, 2021, 611, AUTOCLEAN, GENIUS, GENIUS6-11, GENIUS6-11GAS, GENIUSGAS, MAKT, MB, MD1011, MD523, MD611, MMD611, MULTIMAXA, MULTIMAXB, WU14		

PTFE gaskets

Part No.	518669	Ref. No.	0373079 EL0373079
description	gasket PTFE ED ø 21mm ID ø 15mm thickness 3.5mm		
accessories for	518669		
	Part No.	375889	Ref. No.
			504602 E336029 EL0504602 ELE336029
description	safety thermostat switch-off temp. 360°C 1-pole 16A probe ø 15mm probe L 6.5mm capillary pipe 1140mm capillary pipe isolated 1100mm gland nut probe		

silicone gaskets

Part No.	359721	Ref. No.	425132 693421 976024 E0556 E425005 E425132 EL0976024 ELE425005 ELE425132
description	gasket silicone ED ø 48mm ID ø 39.5mm thickness 5mm Qty 1 pcs		
For models:	EBM3e-McDonalds, JOKERB, JOKERC		

special gaskets

for combi-steamers

Part No.	699835	Ref. No.	E425011 EL0307025
description	gasket external height 18mm ED ø 65mm ID ø 56mm		

Part No.	699472	Ref. No.	0507495 0507997 0874833 EL0507495 EL0507997 EL0874833
description	gasket ignition electrode ID ø 13mm hole ø 6mm L 60mm W 22mm suitable for ELOMA graphite		

mechanical components, equipment accessories

1



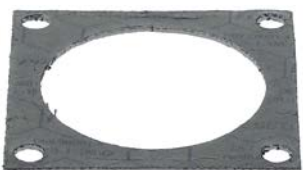

			
1			
Part No.	699471	Ref. No.	0507494 0874876 EL0507494 EL0874876
description	gasket suitable for ELOMA for model Genius T 6-11 10-11 for burner chamber L 108mm W 100mm graphite combi-steamer		

			
1			
Part No.	699470	Ref. No.	0505956 874841 EL0505956 EL0874841
description	gasket suitable for ELOMA for model Genius T 6-11 10-11 for radial fan L 65mm W 82mm for combi-steamer ID ø 25mm graphite thickness 1.7mm		
For models:	1011, 1221, 2011, 2021, 611, GENIUS		

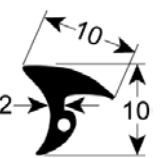
			
1			
Part No.	699469	Ref. No.	0505953 874868 EL0505953 EL0874868
description	gasket suitable for ELOMA for model Genius T 6-11 10-11 L 64mm W 64mm for combi-steamer ID ø 50mm graphite thickness 1.7mm		
For models:	1011, 1221, 2011, 2021, 611, GENIUS		

			
1			
Part No.	560648	Ref. No.	0584096 E425133 EL0584096 ELE425133
description	gasket suitable for ELOMA L 1000mm Qty 1m for combi-steamer		
For models:	JOKERB, JOKERC		

thermostat gaskets			
			
1			
Part No.	518669	Ref. No.	0373079 EL0373079
description	gasket PTFE ED ø 21mm ID ø 15mm thickness 3.5mm		
accessories for	518669		
	Part No.	375889	Ref. No.
			504602 E336029 EL0504602 ELE336029
safety thermostat switch-off temp. 360°C 1-pole 16A probe ø 15mm probe L 6.5mm capillary pipe 1140mm capillary pipe isolated 1100mm gland nut probe			

transmission technology and ball bearings

chains

connectors

			
1			
Part No.	697069	Ref. No.	395021 E395021 ELE395021
description	connector single DIN/ISO 06 B-1 splitting 3/8" links 1 L 17.8mm internal width 8.8mm rollerø 3mm metal		

springs

torsion springs

1			
Part No.	692908	Ref. No.	E416030 ELE416030
description	torsion spring hinged at right ø 35mm L2 13mm wire gauge ø 2.5mm mounting pos. for door handle L1 13mm L3 13mm Qty 1 pcs		
For models:	EDC 20/11		



<p>1</p>			
Part No.	692523	Ref. No.	897531 E416055 E416073 EL0897531 ELE416055 ELE416073
description	torsion spring ø 27.8mm ID ø 21.7mm L2 44mm wire gauge ø 3mm L1 13mm L3 44mm Qty 1 pcs		
For models:	1221, 2021, AUTOCLEAN, GENIUS, MB, MULTIMAXB		

<p>1</p>			
Part No.	692911	Ref. No.	EL0791520
description	torsion spring ø 27mm wire gauge ø 2.3mm mounting pos. door handle L1 11mm Qty 1 pcs		

miscellaneous

<p>1</p>			
Part No.	514450	Ref. No.	791504 EL0791504
description	spring for door handle ø 6mm L 61mm W 27.5mm		

tension springs

<p>1</p>			
Part No.	700030	Ref. No.	416002 527343 EL0527343 ELE416002 G0195
description	tension spring ø 12.9mm total length 187mm wire gauge ø 2.1mm		
<p>1</p>			
Part No.	700031	Ref. No.	514586 EL0514586 G0197
description	tension spring ø 15mm total length 290mm wire gauge ø 2.3mm		

<p>1</p>			
Part No.	700032	Ref. No.	G0199
description	tension spring ø 24.8mm total length 220mm wire gauge ø 3.2mm		

<p>1</p>			
Part No.	700033	Ref. No.	G0201
description	tension spring ø 30mm total length 300mm wire gauge ø 4.1mm		

manometers

<p>1</p>			
Part No.	541979	Ref. No.	224758 E348009 EL0224758 ELE348009 H0376
description	manometer ø 40mm pressure range 0-4bar connection at the rear in the centre thread 1/8"		
For models:	1011, 1221, 2011, 2021, 611, AUTOCLEAN, GENIUS, GENIUS6-11, GENIUS6-11GAS, GENIUSGAS, MAKT, MB, MULTIMAXA, MULTIMAXB		

<p>1</p>			
Part No.	542449	Ref. No.	224758
description	manometer ø 40mm pressure range 0-6bar connection at the rear in the centre thread 1/8"		

hose reels and spray guns

spray guns

<p>1</p>			
Part No.	548636	Ref. No.	EL0393002
description	spray gun 1/2" ET L 250mm		
spare parts for	548636		
Part No.	540457	Ref. No.	—
pressure pin ø 10mm D1 ø 18mm L 48.7mm with spring for spray gun edition ab 03/2016			
Part No.	549970	Ref. No.	—
pressure pin ø 10mm D1 ø 18mm L 50.2mm with spring for spray gun			



1

Part No.	540301	Ref. No.	587583 E250059 EL0587583 EL0783404 ELE250059
description	spray gun for appliances 1/2" ET L 128mm		
For models:	1011, 1221, 2011, 2021, 611, AUTOCLEAN, GENIUS, GENIUS6-11, GENIUS6-11GAS, GENIUSGAS, JOKERB, JOKERC, MAKT, MB, MULTIMAXA, MULTIMAXB, MULTIMAXB6-11AUTOCLEAN		
accessories for	540301		
	Part No.	Ref. No.	EL0504696 ELE444057
	shower hose connections 1/2" L 800mm SS for combi-steamer		



1

Part No.	540158	Ref. No.	393002 A0460 E250004 EL0393002 ELE250004
description	spray gun for appliances 1/2" ET type ECHTERMANN		

1

Part No.	530922	Ref. No.	EL0504696 ELE444057
description	shower hose connections 1/2" L 800mm SS for combi-steamer		
accessories for	530922		
	Part No.	Ref. No.	587583 E250059 EL0587583 EL0783404 ELE250059
	spray gun for appliances 1/2" ET L 128mm		

hose reels

appliance hose reels



1

Part No.	545067	Ref. No.	753181 E250103 EL0753181 ELE250103
description	hose reel without spray gun hose length 1.55m		
For models:	1011, 611, AUTOCLEAN, GENIUS, GENIUS6-11, GENIUS6-11GAS, GENIUSGAS, MAKT, MB, MULTIMAXA, MULTIMAXB, MULTIMAXB6-11AUTOCLEAN		

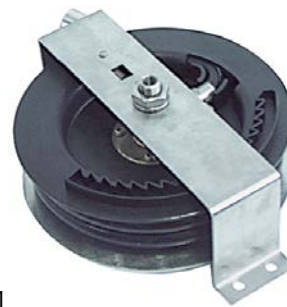

1

Part No.	540480	Ref. No.	580953 E250069 EL0580953 ELE250069
description	hose reel without spray gun hose length 1.7m		



1

Part No.	540481	Ref. No.	E250070 ELE250070
description	hose reel without spray gun hose length 2.1m		
accessories for	540481		
	Part No.	Ref. No.	587583 E250059 EL0587583 EL0783404 ELE250059
	spray gun for appliances 1/2" ET L 128mm		





hoses

pre-rinse hoses

stainless steel spiral tubes

1

Part No.	530922	Ref. No.	EL0504696 ELE444057
description	shower hose connections 1/2" L 800mm SS for combi-steamer		
accessories for	530922		
	Part No.	540301	Ref. No. 587583 E250059 EL0587583 EL0783404 ELE250059
spray gun for appliances 1/2" ET L 128mm			

1 			
Part No.	520024	Ref. No.	253847 593303 E444013 E444050 EL0253847 EL0593303 ELE444013 ELE444050 K0432
description	silicone hose with glass fibre sleeving ID ø 9.5mm ED ø 17mm L 5m thickness 3.75mm operating p. 4bar burst pressure at 95°C 26bar burst pressure 130°C 14bar t.max. 200°C white		
For models:	1011, 1221, 2011, 2021, 611, AUTOCLEAN, GENIUS, GENIUS6-11, GENIUS6-11GAS, GENIUSGAS, MAKT, MB, MD1011, MD2011, MD523, MD611, MMD1011, MMD2011, MMD2021, MMD611, MULTIMAXA, MULTIMAXB, WU14		

industrial hoses

nylon hoses

1

1 			
Part No.	520252	Ref. No.	785857 EL0785857
description	nylon hose ID ø 6mm ED ø 8mm L 5m thickness 1mm operating p. 10bar burst p. 50bar t.max. 100°C white		
For models:	1011, 1221, 2011, 2021, 611, GENIUS, MAKT, MB		

fittings, hose and pipe connectors

hose connectors

miscellaneous

1

1 			
Part No.	501591	Ref. No.	0753890 E440154 EL0753890 ELE440154
description	hose connector stainless steel hose ø 10/13mm M9 for cleaning system combi-steamer		

silicone hoses

with fabric

with glass fibre sleeving

1

1 			
Part No.	520023	Ref. No.	375500 E444014 EL0375500 ELE444014 K0435
description	silicone hose with glass fibre sleeving ID ø 6mm ED ø 12mm L 5m thickness 3mm operating p. 4bar burst pressure at 95°C 26bar burst pressure 130°C 14bar t.max. 200°C white temp.-resist. max. 200°C		
For models:	MD1011, MD2011, MD523, MD611, MMD1011, MMD2011, MMD2021, MMD611		

fittings

double nipples

1

1 			
Part No.	520160	Ref. No.	440092 754447 E440156 EL0440092 EL0754447 ELE440156
description	double nipple nickel-plated brass thread 1/8" - 1/8" Qty 1 pcs		
For models:	1011, 1221, 2011, 2021, 611, AUTOCLEAN, EB30, EB30XLDIGITAL, EBM5, EDC6-11, ELH101, ELH61, GENIUS, GENIUS6-11, GENIUS6-11GAS, GENIUSGAS, MAKT, MB, MD1011, MD2011, MD523, MD611, MMC1011, MMC2011, MMC2021, MMC611, MMD1011, MMD2011, MMD2021, MMD611, MULTIMAXA, MULTIMAXB		



			
1			
Part No.	521187	Ref. No.	570451 E440047 EL0570451 ELE440047 H0654
description	double nipple nickel-plated brass thread 1/8" - 3/8" Qty 1 pcs int. ø 1.5mm int. ø 2.9.3mm		
For models:	EB30, EB30XLDIGITAL, MD1011, MD2011, MD523, MD611, MMD1011, MMD2011, MMD2021, MMD611		

reducers			
			
1			
Part No.	520963	Ref. No.	E440039 EL0249696 ELE440039
description	reducer thread 3/4" ET - 3/8" IT nickel-plated brass total length 26.5mm WS 27 Qty 1 pcs		
For models:	1011, 1221, 2011, 2021, 611, AUTOCLEAN, GENIUS, GENIUS6-11, GENIUS6-11GAS, GENIUSGAS, JOKERB, JOKERC, MULTIMAXA, MULTIMAXB		



angle pieces			
			
1			
Part No.	520824	Ref. No.	773719 E440172
description	angle piece thread 1/8" ET - 1/8" IT nickel-plated brass		
For models:	1011, 1221, 2011, 2021, 611, AUTOCLEAN, EB30, EB30XLDIGITAL, GENIUS, GENIUS6-11, GENIUS6-11GAS, GENIUSGAS, MB, MULTIMAXA, MULTIMAXB		

water cycle components

pressure reduction valves

pressure reduction valves

producer-specific

				
1				
Part No.	520502	Ref. No.	577316 871419 E0731 E436009 E598198 EL0871419 ELE436009 ELE598198	
description	pressure reduction valve Norgren series R91 connection 1/8" default settingbar setting range 0.1-3bar p max 10bar t.max. 50°C brass			
For models:	1011, 1221, 2011, 2021, 611, AUTOCLEAN, GENIUS, GENIUS6-11, GENIUS6-11GAS, GENIUSGAS, JOKERB, JOKERC, MAKT, MB, MULTIMAXA, MULTIMAXB			
accessories for	520502			
	Part No.	541979	Ref. No.	224758 E348009 EL0224758 ELE348009 H0376
	manometer ø 40mm pressure range 0-4bar connection at the rear in the centre thread 1/8"			
	Part No.	542449	Ref. No.	224758
	manometer ø 40mm pressure range 0-6bar connection at the rear in the centre thread 1/8"			

ancillary products

thread sealants

			
1			
Part No.	890058	Ref. No.	593567
description	thread sealing LOCTITE 511 liquid bottle 50ml		
description	LOCTITE® 511™ - bottle 50ml It is designed for the locking and sealing of metal threaded pipes and fittings. The product cures rapidly when confined in the absence of air between close fitting metal surfaces.		
For models:	1011, 1221, 2011, 2021, 611, EB30, EB30XLDIGITAL, GENIUS, MAKT, MB		



silicone

food-grade silicones



Part No.	890106	Ref. No.	E522026 EL0063096 ELE522026
description	silicone TB40 transparent tube 90g -40 up to +160°C		
description	Tomabond - TB40 - tube 90g - transparent For flexible sealing in drinking water, food, water and industrial kitchen areas. Securely joins glass, metal, wood-based materials, ceramic and plastics with high adhesion (1.1 N/mm²). Fungicide-, algicide- and solvent-free, ageing-resistant. Temperature-resistant from -40 °C to +160 °C Tested and approved by KTW / KSW.		

Part No.	520070	Ref. No.	276642 E422019 EL0276642 ELE422019 H0285
description	hose clamp SS/brass ø 16-21mm width 11mm Qty 5 pcs		
For models:	1011, 611, GENIUS, MAKT, MB		

Part No.	520071	Ref. No.	572160 E422020 EL0572160 ELE422020 H0286
description	hose clamp SS/brass ø 17-22mm width 11mm Qty 5 pcs		
For models:	1011, 1221, 2011, 2021, 611, AUTOCLEAN, GENIUS, GENIUS6-11, GENIUS6-11GAS, GENIUSGAS, MB, MULTIMAXA, MULTIMAXB, WU14		

clamps

hose clamps

DIN 3017 - W2



Part No.	520116	Ref. No.	422007 EL0422007
description	hose clamp ø 32-50mm width 9mm Qty 5 pcs DIN 3017		
For models:	MMC1011, MMC611, MMD1011, MMD611		

Part No.	520067	Ref. No.	277665 E422017 EL0277665 ELE422017 H0282
description	hose clamp SS/brass ø 9-14mm width 10mm Qty 5 pcs		
For models:	1011, 1221, 2011, 2021, 611, AUTOCLEAN, EB30, EB30XLDIGITAL, GENIUS, GENIUS6-11, GENIUS6-11GAS, GENIUSGAS, MD1011, MD2011, MD523, MD611, MMD1011, MMD2011, MMD2021, MMD611, MULTIMAXA, MULTIMAXB, WU14		

security hose clamps

SS/brass



Part No.	520069	Ref. No.	276634 E422018 EL0276634 ELE422018 H0284
description	hose clamp SS/brass ø 14-19mm width 11mm Qty 5 pcs		
For models:	1011, 1221, 2011, 2021, 611, AUTOCLEAN, EB30, EB30XLDIGITAL, GENIUS, GENIUS6-11, GENIUS6-11GAS, GENIUSGAS, MAKT, MB, MD1011, MD2011, MD523, MD611, MMD1011, MMD2011, MMD2021, MMD611, MULTIMAXA, MULTIMAXB		

fastening material

screws

sheet metal screws



Part No.	560104	Ref. No.	EL0011800
description	sheet metal screws ø 3.9mm L 19mm SS Qty 20 pcs DIN 7981/ ISO 7049 head ø 7.5mm oval head		



countersunk screws



1

Part No.	560450	Ref. No.	ELE500172
description	countersunk screw thread M4 L 8mm SS DIN 965/ISO 7046 Qty 1 pcs intake Phillips head ϕ 7.3mm		

flat-headed bolts

1

Part No.	560491	Ref. No.	162469 E500096 EL0162469 ELE500096 N0206
description	flat-headed bolt thread M3 thread L 16mm stainless steel DIN 7985 Qty 20 pcs intake Phillips head ϕ 6mm head thickness 2.5mm		



1

Part No.	560063	Ref. No.	EL0037311
description	flat-headed bolt thread M4 thread L 16mm SS DIN 7985/ISO 7045 Qty 20 pcs intake Phillips head ϕ 8mm head thickness 2mm		



1

Part No.	102600	Ref. No.	ELE500102
description	screw thread M4 thread L 25mm Minisit		

hexagonal screws



1

Part No.	560084	Ref. No.	231657 E500021 EL0231657 ELE500021 N0052
description	hexagonal screw thread M5 thread L 16mm SS WS 8 Qty 20 pcs DIN 933 / ISO 4017		
For models:	1011, 1221, 2011, 611, GENIUS, MAKT, MB, MD1011, MD523, MD611, MMD1011, MMD611		



1

Part No.	560086	Ref. No.	251836
description	hexagonal screw thread M6 thread L 10mm SS WS 10 Qty 20 pcs DIN 933 / ISO 4017		
For models:	EB30, EB30XLDIGITAL		

cylinder head bolts

DIN 912/ISO 4762

1

Part No.	560025	Ref. No.	500070 E500070 ELE500070
description	cylinder head bolt thread M4 thread L 10mm WS 3 SS Qty 20 pcs DIN 912/ISO 4762		

grub screws

DIN 913/ISO 4026

1

Part No.	560497	Ref. No.	753785 E500268 EL0753785 ELE500268
description	grub screw thread M8 L 8mm A2-A2L DIN 913/ISO 4026 WS 4 Qty 20 pcs		
For models:	1011, 1221, 2011, 2021, 611, AUTOCLEAN, GENIUS, GENIUS6-11, GENIUS6-11GAS, GENIUSGAS, MB, MULTIMAXB		

DIN 916/ISO 4029

1

Part No.	560173	Ref. No.	588512 895415 E500203 E500261 EL0588512 EL0895415 ELE500203 N0044
description	grub screw thread M4 L 10mm SS DIN 916/ISO 4029 intake internal hexagon WS 2 Qty 20 pcs		
For models:	1011, 1221, 2011, 2021, 611, AUTOCLEAN, GENIUS, GENIUS6-11, GENIUS6-11GAS, GENIUSGAS, JOKERB, JOKERC, MAKT, MB, MD2011, MMD2011, MMD2021, MULTIMAXA, MULTIMAXB		





miscellaneous			
			
1			
Part No.	560621	Ref. No.	399280 E440101 EL0399280 ELE440101
description	grub screw thread 1/8" L 5mm brass WS hexagonal 5mm Qty 1 pcs		
For models:	1011, 1221, 2011, 2021, 611, AUTOCLEAN, GENIUS, GENIUS6-11, GENIUS6-11GAS, GENIUSGAS, JOKERB, JOKERC, MAKT, MB, MULTIMAXA, MULTIMAXB		

nuts			
plate nuts			
			
1			
Part No.	560004	Ref. No.	E505046 ELE505046 H0630
description	plate nut hole ø 2.9mm L 17mm W 12mm		
For models:	MD1011, MD2011, MD523, MD611, MMD1011, MMD2011, MMD2021, MMD611		

hexagonal nuts			
DIN 934 / ISO 4032/8673			
			
1			
Part No.	560340	Ref. No.	003905
description	hexagonal nut thread M4 H 3.2mm WS 7 SS DIN/ISO DIN 934 / ISO 4032/8673 Qty 1 pcs		
For models:	1011, 1221, 2011, 2021, 611, EB30, EB30XLDIGITAL, GENIUS, MAKT, MB		

			
1			
Part No.	560132	Ref. No.	EL0252867
description	hexagonal nut thread M5 H 4mm WS 8 SS DIN/ISO DIN 934 / ISO 4032/8673 Qty 20 pcs		

			
1			
Part No.	560133	Ref. No.	EL0251887
description	hexagonal nut thread M6 H 5mm WS 10 SS DIN/ISO DIN 934 / ISO 4032/8673 Qty 20 pcs		

			
1			
Part No.	506166	Ref. No.	E505027 EL0012343
description	nut thread M12 H 10mm WS 19 SS DIN/ISO DIN 934 / ISO 4032/8673 Qty 1 pcs		

DIN 985			
			
1			
Part No.	560143	Ref. No.	0587095 EL587095
description	hexagonal nut thread M8 H 8.5mm SS WS 13 Qty 20 pcs DIN/ISO DIN 985 self-locking		

hexagonal nuts metric (without norm)			
			
1			
Part No.	519646	Ref. No.	E505106 EL0765651 ELE505106
description	nut thread M9x0.75 H 2.5mm WS 14 SS Qty 1 pcs		

washers			
DIN 125A			
			
1			
Part No.	560332	Ref. No.	EL001007
description	plain washer ID ø 4.3mm ED ø 9mm thickness 0.8mm SS Qty 1 pcs		





			
1			
Part No.	560112	Ref. No.	EL0003980
description	plain washer ID ø 5.3mm ED ø 10mm thickness 1mm SS Qty 20 pcs DIN 125A for thread M5		

DIN 9021			
			
1			
Part No.	560117	Ref. No.	000582 E508033 EL0000582
description	plain washer ID ø 6.4mm ED ø 18mm thickness 1.5mm SS Qty 20 pcs DIN 9021 for thread M6		
For models:	1011, 1221, 2011, 2021, 611, AUTOCLEAN, EB30, EB30XLDIGITAL, GENIUS, GENIUS6-11, GENIUS6-11GAS, GENIUSGAS, JOKERB, JOKERC, MAKT, MB, MULTIMAXA, MULTIMAXB, MULTIMAXB6-11AUTOCLEAN		

tooth lock washers			
DIN 6798A			
			
1			
Part No.	560193	Ref. No.	0349771 EL0349771
description	tooth lock washer ID ø 10.4mm ED ø 18mm zinc-coated steel DIN/ISO DIN 6798A Qty 1 pcs for thread M10		

			
1			
Part No.	560127	Ref. No.	892912
description	tooth lock washer ID ø 6.2mm ED ø 11mm SS DIN/ISO DIN 6798A Qty 20 pcs for thread M6		
For models:	1011, 1221, 2011, 2021, 611, EB30, EB30XLDIGITAL, GENIUS, MAKT, MB		

fasteners			
slot nuts			
			
1			
Part No.	694995	Ref. No.	0760978 EL0760978 ELE512082
description	slot nut W 4mm H 5mm L 12mm half-round for door latch DIN 6888		
For models:	1221, 2021, GENIUS, MB		

clamps			
hose clamps			
DIN 3017 - W2			
			
1			
Part No.	520116	Ref. No.	422007 EL0422007
description	hose clamp ø 32-50mm width 9mm Qty 5 pcs DIN 3017		
For models:	MMC1011, MMC611, MMD1011, MMD611		

security hose clamps			
SS/brass			
			
1			
Part No.	520069	Ref. No.	276634 E422018 EL0276634 ELE422018 H0284
description	hose clamp SS/brass ø 14-19mm width 11mm Qty 5 pcs		
For models:	1011, 1221, 2011, 2021, 611, AUTOCLEAN, EB30, EB30XLDIGITAL, GENIUS, GENIUS6-11, GENIUS6-11GAS, GENIUSGAS, MAKT, MB, MD1011, MD2011, MD523, MD611, MMD1011, MMD2011, MMD2021, MMD611, MULTIMAXA, MULTIMAXB		

			
1			
Part No.	520070	Ref. No.	276642 E422019 EL0276642 ELE422019 H0285
description	hose clamp SS/brass ø 16-21mm width 11mm Qty 5 pcs		
For models:	1011, 611, GENIUS, MAKT, MB		

			
1			
Part No.	520071	Ref. No.	572160 E422020 EL0572160 ELE422020 H0286
description	hose clamp SS/brass ø 17-22mm width 11mm Qty 5 pcs		
For models:	1011, 1221, 2011, 2021, 611, AUTOCLEAN, GENIUS, GENIUS6-11, GENIUS6-11GAS, GENIUSGAS, MB, MULTIMAXA, MULTIMAXB, WU14		



 <p>1</p>			
Part No.	520067	Ref. No.	277665 E422017 EL0277665 ELE422017 H0282
description	hose clamp SS/brass ø 9-14mm width 10mm Qty 5 pcs		
For models:	1011, 1221, 2011, 2021, 611, AUTOCLEAN, EB30, EB30XLDIGITAL, GENIUS, GENIUS6-11, GENIUS6-11GAS, GENIUSGAS, MD1011, MD2011, MD523, MD611, MMD1011, MMD2011, MMD2021, MMD611, MULTIMAXA, MULTIMAXB, WU14		

<p>roll pins</p>  <p>1</p>			
Part No.	692474	Ref. No.	ELE512046
description	roll pin ø 2.5mm L 20mm		

 <p>1</p>			
Part No.	691637	Ref. No.	512046 E512046
description	roll pin ø 3mm L 20mm		

consumables

sealants and adhesives

high temperature silicone

 <p>1</p>			
Part No.	890107	Ref. No.	500402 E522021 EL0500402 ELE522021 H0635
description	high temperature silicone TOMABOND TB76 -40 up to +250°C red/ brown tube 90ml		
description	Tomabond TB76 - tube 90ml - red brown Special elastic silicone for general bonding & sealing applications with high thermal loads. TB 76 is primarily used in building services, HVAC and mechanical engineering. Temperature-resistant to 300 °C over the short term		
For models:	1221, 2021, GENIUS, MB, MD2011, MMD2011, MMD2021		

food-grade silicones

 <p>1</p>			
Part No.	890106	Ref. No.	E522026 EL0063096 ELE522026
description	silicone TB40 transparent tube 90g -40 up to +160°C		
description	Tomabond - TB40 - tube 90g - transparent For flexible sealing in drinking water, food, water and industrial kitchen areas. Securely joins glass, metal, wood-based materials, ceramic and plastics with high adhesion (1.1 N/mm²). Fungicide-, algicide- and solvent-free, ageing-resistant. Temperature-resistant from -40 °C to +160 °C Tested and approved by KTW / KSW.		



thread sealants



Part No.	890058	Ref. No.	593567
description	thread sealing LOCTITE 511 liquid bottle 50ml		
description	LOCTITE® 511™ - bottle 50ml It is designed for the locking and sealing of metal threaded pipes and fittings. The product cures rapidly when confined in the absence of air between close fitting metal surfaces.		
For models:	1011, 1221, 2011, 2021, 611, EB30, EB30XLDIGITAL, GENIUS, MAKT, MB		

fuses

fine fuses



Part No.	358532	Ref. No.	190756 E0173 E375007 EL0190756 ELE375007
description	fine fuse size ø5x20mm 2A fast-acting rated 250V Qty 10 pcs		
For models:	1011, 1221, 2011, 2021, 611, AUTOCLEAN, GENIUS, GENIUS6-11, GENIUS6-11GAS, GENIUSGAS, JOKERC, MAKT, MB, MD1011, MD2011, MD611, MMD1011, MMD2011, MMD2021, MMD611, MULTIMAXA, MULTIMAXB		



Part No.	358699	Ref. No.	572047 E0168 E375004 EL0572047 ELE375004
description	fine fuse size ø5x20mm 10A medium lag rated 250V Qty 10 pcs		
For models:	JOKERC, MD2011, MMD1011, MMD2011, MMD2021, MMD611, WU14		



Part No.	358697	Ref. No.	E0167 E375003 ELE375003
description	fine fuse size ø5x20mm 6.3A medium lag rated 250V Qty 10 pcs		



Part No.	358608	Ref. No.	578975 EL0578975
description	fine fuse size ø5x20mm 10A slow-acting rated 250V Qty 10 pcs		
For models:	1011, 1221, 2011, 2021, 611, GENIUS, MAKT, MB		

fine fuse holders



Part No.	358049	Ref. No.	751847 E0965 E373028 EL0751847 ELE373028
description	fuse holder		
For models:	1221, 2011, 2021, AUTOCLEAN, GENIUS, MAKT, MB, MD2011, MMD2011, MMD2021, MULTIMAXA, MULTIMAXB		

screw locks

D0-system (NEOZED)



Part No.	358043	Ref. No.	658294 E0974 E375015 EL0658294 ELE375015
description	fuse size D01 16A rated 250/400V E14 ø 11mm L 36mm Qty 10 pcs		
For models:	1221, 2021, AUTOCLEAN, GENIUS, MB, MD2011, MMD2011, MMD2021, MULTIMAXB		





Part No.	358045	Ref. No.	751863 E0970 E375013 EL0751863 ELE375013
description	fuse size D02 35A rated 250/400V E18 ø 15mm L 36mm Qty 10 pcs		
For models:	2011, AUTOCLEAN, GENIUS, MAKT, MB, MD2011, MMD2011, MMD2021, MULTIMAXA, MULTIMAXB		



 <p>1</p>			
Part No.	358046	Ref. No.	658286 E0969 E375012 E0658286 ELE375012
description	fuse size D02 50A rated 250/400V E18 ø 15mm L 36mm Qty 10 pcs		
For models:	1221, 2021, AUTOCLEAN, GENIUS, MB, MD2011, MMD2011, MMD2021, MULTIMAXB		

 <p>1</p>			
Part No.	358067	Ref. No.	751855 E0972 E373021 E0751855 ELE373021
description	gauge piece size D02 suitable for 35A		
For models:	2011, AUTOCLEAN, GENIUS, MAKT, MB, MD2011, MMD2011, MMD2021, MULTIMAXA, MULTIMAXB		

gauge pieces (NEOZED)			
 <p>1</p>			
Part No.	358064	Ref. No.	658308 E0976 E373023 E0658308
description	gauge piece size D02 suitable for 16A		
For models:	1221, 2021, AUTOCLEAN, GENIUS, MB, MD2011, MMD2011, MMD2021, MULTIMAXB		

 <p>1</p>			
Part No.	358068	Ref. No.	658278 E0971 E373020 ELE373020
description	gauge piece size D02 suitable for 50A		
For models:	1221, 2021, AUTOCLEAN, GENIUS, MB, MD2011, MMD2011, MMD2021, MULTIMAXB		

GASTROPARTS.COM

