



GASTROPARTS

Elframo

- [EN]** Equipment
- [DE]** Geräte
- [ES]** Aparatos
- [FR]** Équipement
- [IT]** Attrezzature
- [PL]** Urządzenia
- [RU]** Оборудование

✉ gastroparts@gastroparts.com

☎ +48 56 657 00 66

📘 fb.com/gastroparts.global

GASTROPARTS.COM





heating elements



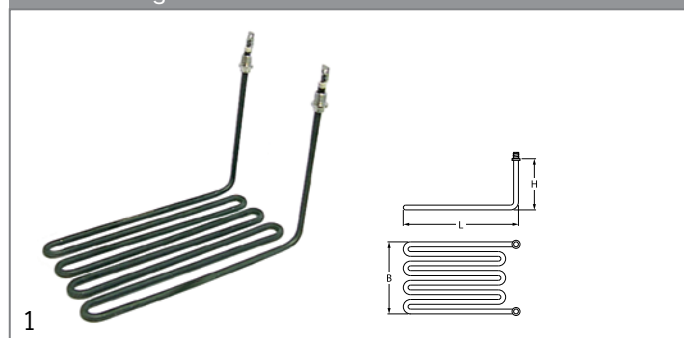

heating elements for fryers

2 hole fixing

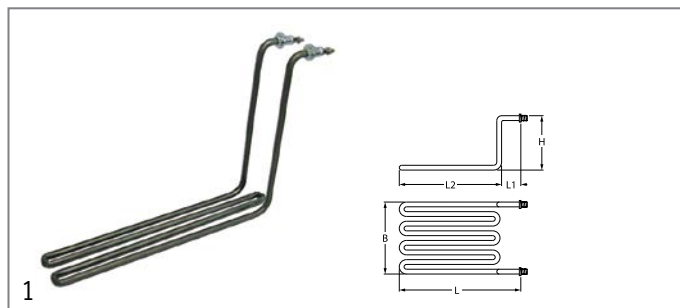

Part No.	415920	Ref. No.	00033120
description	heating element 2800W 230V heating circuits 1 L 280mm W 160mm H 185mm thread 1/4" tube ø 8.5mm windings 4 connection M4 2 hole fixing fryer heaters		
For models:	EB6, EB6+6		
accessories for	415920		
	Part No.	510417	Ref. No. —
	flat gasket fibre ED ø 20mm ID ø 14mm thickness 2mm Qty 1 pcs		
	Part No.	520228	Ref. No. —
	tooth lock washer ID ø 15.3mm ED ø 24mm steel Qty 1 pcs for thread M14		
	Part No.	520230	Ref. No. —
	nut thread M14x1.5 H 5mm WS 19 zinc-coated steel Qty 1 pcs		
	Part No.	521101	Ref. No. —
	nut thread M14x1.5 H 5mm WS 19 SS Qty 1 pcs		
	Part No.	521103	Ref. No. —
	nut thread M4 H 3mm WS 7 brass Qty 20 pcs		
	Part No.	521104	Ref. No. —
	washer ID ø 4.3mm ED ø 8mm thickness 0.5mm brass Qty 20 pcs for thread M4		
	Part No.	550262	Ref. No. —
	flat gasket copper ED ø 20mm ID ø 14mm thickness 2mm		
	Part No.	560111	Ref. No. —
	plain washer ID ø 4.3mm ED ø 9mm thickness 0.8mm SS Qty 20 pcs DIN 125A for thread M4		
	Part No.	560131	Ref. No. —
	hexagonal nut thread M4 H 3.2mm WS 7 SS DIN/ISO DIN 934 / ISO 4032/8673 Qty 20 pcs		



Part No.	415921	Ref. No.	00033130
description	heating element 1260W 230V heating circuits 1 L 320mm W 48mm H 220mm L1 22mm L2 298mm thread 1/4" tube ø 8.5mm windings 2 2 hole fixing connection M4 fryer heaters		
For models:	EB18P, EB8		
accessories for	415921		
	Part No.	521103	Ref. No. —
	nut thread M4 H 3mm WS 7 brass Qty 20 pcs		
	Part No.	521104	Ref. No. —
	washer ID ø 4.3mm ED ø 8mm thickness 0.5mm brass Qty 20 pcs for thread M4		
	Part No.	560111	Ref. No. —
	plain washer ID ø 4.3mm ED ø 9mm thickness 0.8mm SS Qty 20 pcs DIN 125A for thread M4		
	Part No.	560131	Ref. No. —
	hexagonal nut thread M4 H 3.2mm WS 7 SS DIN/ISO DIN 934 / ISO 4032/8673 Qty 20 pcs		







group 7



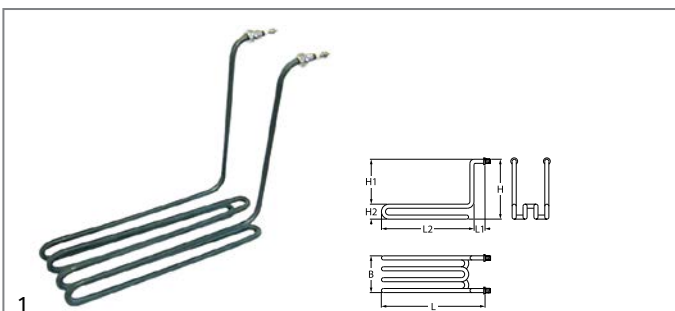





Part No.	420210	Ref. No.	00039276
description	heating element 1600W 230V heating circuits 1 L 283mm W 75mm H 200mm 2 hole fixing connection male faston 6.3mm immersion heater L1 10mm L2 273mm W1 12.5mm W2 50mm H1 20mm H2 180mm tube ø 8.5mm thread 1/4" mounting distance 41.5mm windings 2		
For models:	ST7, ST7+7		

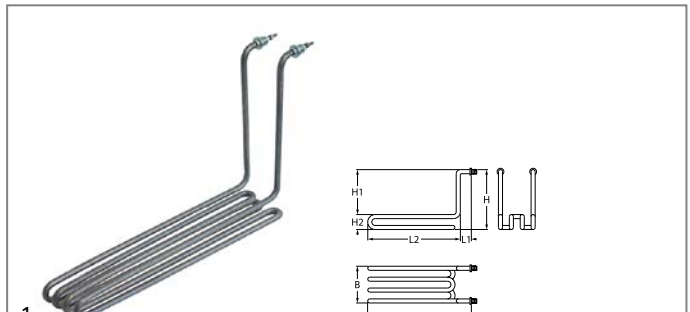

			
Part No.	416783	Ref. No.	00033154 00033155
description	heating element 5500W 230V heating circuits 1 L 250mm W 60mm H 250mm L1 22mm L2 375mm H1 206mm H2 44mm thread M14x1.5 tube \varnothing 8.5mm 2 hole fixing connection M4 fryer heaters windings 6		
For models:	EM20, EM20+20, ES20, ESD20, FE20, FE20+20, FE30, FE30+30, KES20, KESD20		
accessories for	416783		
	Part No.	521103	Ref. No. —
	nut thread M4 H 3mm WS 7 brass Qty 20 pcs		
	Part No.	521104	Ref. No. —
	washer ID \varnothing 4.3mm ED \varnothing 8mm thickness 0.5mm brass Qty 20 pcs for thread M4		
	Part No.	560111	Ref. No. —
	plain washer ID \varnothing 4.3mm ED \varnothing 9mm thickness 0.8mm SS Qty 20 pcs DIN 125A for thread M4		
	Part No.	560131	Ref. No. —
	hexagonal nut thread M4 H 3.2mm WS 7 SS DIN/ISO DIN 934 / ISO 4032/8673 Qty 20 pcs		

			
Part No.	415924	Ref. No.	00033142
description	heating element 3000W 230V heating circuits 1 L 297mm W 86mm H 243mm L1 22mm L2 275mm H1 207mm H2 36mm thread 1/4" mounting distance 34mm tube \varnothing 8.5mm 2 hole fixing connection M4 fryer heaters windings 4		
For models:	EB12, EB12+12, EB18P, EB6, EB6+6, EB8, EM12, EM12+12, ES12, ESD12, FE12		
accessories for	415924		
	Part No.	361182	Ref. No. —
	nut thread 1/4" H 5mm nickel-plated brass WS 17 Qty 1 pcs		
	Part No.	510417	Ref. No. —
	flat gasket fibre ED \varnothing 20mm ID \varnothing 14mm thickness 2mm Qty 1 pcs		
	Part No.	520228	Ref. No. —
	tooth lock washer ID \varnothing 15.3mm ED \varnothing 24mm steel Qty 1 pcs for thread M14		
	Part No.	521103	Ref. No. —
	nut thread M4 H 3mm WS 7 brass Qty 20 pcs		
	Part No.	521104	Ref. No. —
	washer ID \varnothing 4.3mm ED \varnothing 8mm thickness 0.5mm brass Qty 20 pcs for thread M4		

accessories for	415924		
	Part No.	550262	Ref. No. —
	flat gasket copper ED \varnothing 20mm ID \varnothing 14mm thickness 2mm		
	Part No.	560111	Ref. No. —
	plain washer ID \varnothing 4.3mm ED \varnothing 9mm thickness 0.8mm SS Qty 20 pcs DIN 125A for thread M4		
	Part No.	560131	Ref. No. —
	hexagonal nut thread M4 H 3.2mm WS 7 SS DIN/ISO DIN 934 / ISO 4032/8673 Qty 20 pcs		

			
Part No.	416782	Ref. No.	00033150 00033151
description	heating element 3333W 230V heating circuits 1 L 395mm W 85mm H 245mm L1 23mm L2 375mm H1 210mm H2 35mm thread 1/4" mounting distance 76mm tube \varnothing 8.5mm 2 hole fixing connection M4 connection length 37mm fryer heaters windings 4		
For models:	EM20, EM20+20, EM20-900, ES20, ESD20, FE20, FE20+20, FE30, FE30+30		
accessories for	416782		
	Part No.	521103	Ref. No. —
	nut thread M4 H 3mm WS 7 brass Qty 20 pcs		
	Part No.	521104	Ref. No. —
	washer ID \varnothing 4.3mm ED \varnothing 8mm thickness 0.5mm brass Qty 20 pcs for thread M4		
	Part No.	560111	Ref. No. —
	plain washer ID \varnothing 4.3mm ED \varnothing 9mm thickness 0.8mm SS Qty 20 pcs DIN 125A for thread M4		
	Part No.	560131	Ref. No. —
	hexagonal nut thread M4 H 3.2mm WS 7 SS DIN/ISO DIN 934 / ISO 4032/8673 Qty 20 pcs		

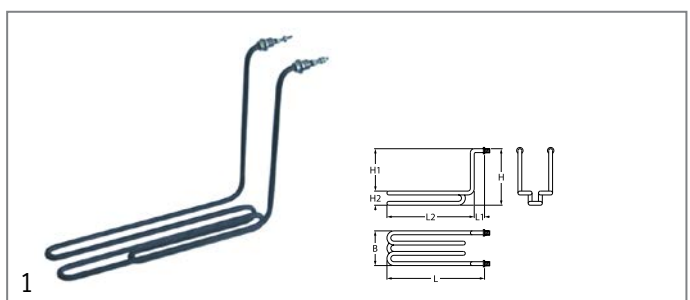
			
Part No.	415922	Ref. No.	00033140
description	heating element 1680W 230V windings 2		
For models:	EB12, EB12+12, EB18P, EB6, EB6+6, EB8, EM12		

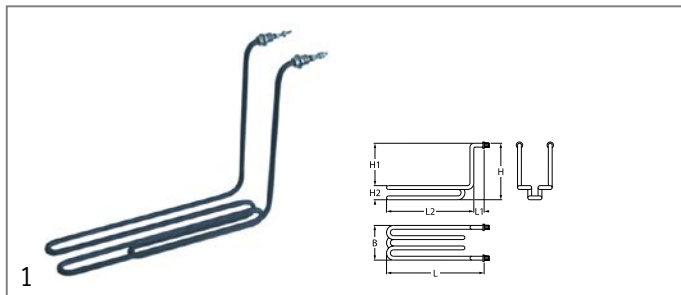

Part No.	415923	Ref. No.	00033141
description	heating element 2000W 230V heating circuits 1 L 315mm W 74mm H 250mm L1 20mm L2 295mm H1 214mm H2 36mm thread 1/4" mounting distance 66mm tube ø 8.5mm 2 hole fixing connection M4 fryer heaters windings 2 fryer		
For models:	EB12, EB12+12, EB18P, EB6, EB6+6, EB8, EM12, EM12+12, ES12, ESD12, FE12		

spare parts for	415923			
	Part No.	510417	Ref. No.	—
	flat gasket fibre ED ø 20mm ID ø 14mm thickness 2mm Qty 1 pcs			
accessories for	415923			
	Part No.	361182	Ref. No.	—
	nut thread 1/4" H 5mm nickel-plated brass WS 17 Qty 1 pcs			
	Part No.	520228	Ref. No.	—
	tooth lock washer ID ø 15.3mm ED ø 24mm steel Qty 1 pcs for thread M14			
	Part No.	521103	Ref. No.	—
	nut thread M4 H 3mm WS 7 brass Qty 20 pcs			
	Part No.	521104	Ref. No.	—
	washer ID ø 4.3mm ED ø 8mm thickness 0.5mm brass Qty 20 pcs for thread M4			
	Part No.	550262	Ref. No.	—
	flat gasket copper ED ø 20mm ID ø 14mm thickness 2mm			
	Part No.	560111	Ref. No.	—
	plain washer ID ø 4.3mm ED ø 9mm thickness 0.8mm SS Qty 20 pcs DIN 125A for thread M4			
	Part No.	560131	Ref. No.	—
	hexagonal nut thread M4 H 3.2mm WS 7 SS DIN/ISO DIN 934 / ISO 4032/8673 Qty 20 pcs			

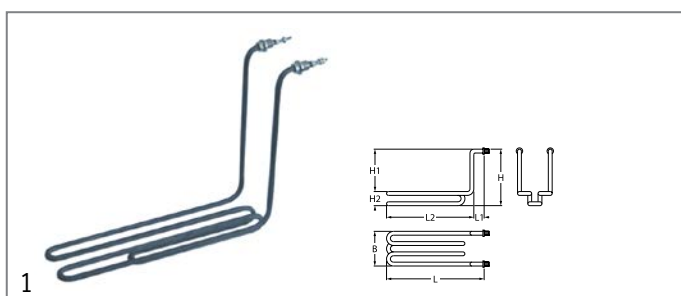

Part No.	419056	Ref. No.	00033145
description	heating element 2000W 240V heating circuits 1 L 315mm W 74mm H 250mm L1 20mm L2 295mm H1 214mm H2 36mm thread 1/4" mounting distance 66mm tube ø 8.5mm 2 hole fixing connection M4 fryer heaters windings 2 fryer		
For models:	EB12, EB12+12, ES12, ESD12		

6 hole fixing



Part No.	420209	Ref. No.	00039278
description	heating element 9000W 230V heating circuits 3 L 310mm W 180mm H 235mm L1 10mm L2 300mm thread 1/4" mounting distance 34.5mm tube ø 8.5mm 6 hole fixing connection male faston 6.3mm immersion heater fryer		
For models:	ST12, ST12+12		

coil heating elements

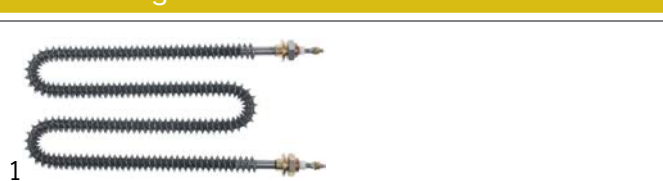

Part No.	420345	Ref. No.	00055600 00055640
description	heating element 1400W 230V L 285mm W 135mm ø 19.5mm thread 3/8" connection M5 for drying heating circuits 1 2 hole fixing		
For models:	EN, ET, ET020, ETA, ETE20, ETE21, ETE25, ETE27, ETS15		

immersion heating elements

miscellaneous

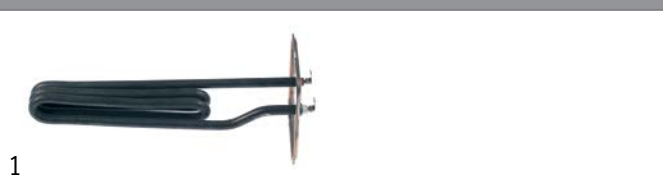



Part No.	418574	Ref. No.	00203052 00203053
description	heating element 3000W 230V heating circuits 1 L 233mm W 45mm H 29mm rectangular flange hole distance 50mm hole ø 9.5mm connection male faston 6.3mm tube ø 8.5mm flange length 96mm flange width 80mm immersion heater INCOLOY-800		
For models:	BD13, BD14, BD46, BD47, BD50, BE35, BE40, BE50		

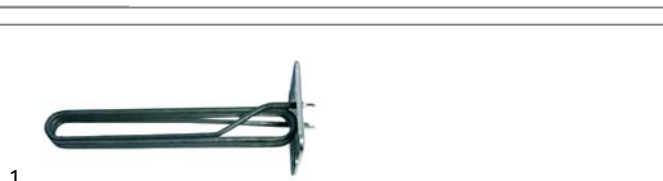

accessories for	418574			
	Part No.	510401	Ref. No.	00003430
	gasket rubber L 88mm W 73mm thickness 5mm hole ø 7mm hole distance 65mm for heating element 4 holes ID ø 50mm			











Part No.	415178	Ref. No.	00203049
description	heating element 3000W 230V immersion heater		
For models:	42, 42E, 48, 48E, 55, 55E, 60, 882, B11, B15, BD11, BD13, BD14, BD14alt, BD22, BE35, BE40, BE50, D30		







			
1			
Part No.	418548	Ref. No.	00003305 00003324 00003325
description	heating element 5200W 230V heating circuits 3 L 325mm W 47mm H 50mm tube ø 8.5mm hole distance 62mm hole ø 9.3mm connection M4 4 hole flange immersion heater flange width 81mm flange length 96mm with thermal fuse		
For models:	120, 160, 240, 885, 904, 906, 908, 912, C33, C34, C34dgt, C44, C44dgt, C44dgt-elt, C66, C66dgt, C66dgt-elt, C77, CE24, D120, D120dgt, D30, D35, D36, D40, D40ELT, D40ELT-BT-BA, D40i, D40i-BT-BA, D40i-ELT-BTBA, D45, D80, D80F, D85, LP60		
spare parts for	418548		
	Part No.	510401	Ref. No. 00003430
	gasket rubber L 88mm W 73mm thickness 5mm hole ø 7mm hole distance 65mm for heating element 4 holes ID ø 50mm		

			
1			
Part No.	415031	Ref. No.	00003324
description	heating element 5700W 230V heating circuits 3		
accessories for	415031		
	Part No.	510401	Ref. No. 00003430
	gasket rubber L 88mm W 73mm thickness 5mm hole ø 7mm hole distance 65mm for heating element 4 holes ID ø 50mm		





			
1			
Part No.	415032	Ref. No.	00003330 00003334
description	heating element 7500W 230V heating circuits 3 4 hole flange immersion heater		
For models:	120, 160, 240, 882, 885, 904, 906, 908, 912, C33, C34, C34dgt, C44, C66, C66dgt, C66dgt-elt, C77, D120, D120dgt, D30, D36, D40, D40ELT, D40ELT-BT-BA, D40i, D40i-ELT-BT-BA, D45, D80, D80F, D85, EN, ET, ET020, ETA, ETE20, ETE21, ETE25, ETE27, ETS15, LP130, LP60, LP60H, LP61, LP61H, LP70, LPE100, LPE145, SQ885, SQT80		
accessories for	415032		
	Part No.	510401	Ref. No. 00003430
	gasket rubber L 88mm W 73mm thickness 5mm hole ø 7mm hole distance 65mm for heating element 4 holes ID ø 50mm		
	Part No.	521103	Ref. No. —
	nut thread M4 H 3mm WS 7 brass Qty 20 pcs		
	Part No.	521104	Ref. No. —
	washer ID ø 4.3mm ED ø 8mm thickness 0.5mm brass Qty 20 pcs for thread M4		
	Part No.	560111	Ref. No. —
	plain washer ID ø 4.3mm ED ø 9mm thickness 0.8mm SS Qty 20 pcs DIN 125A for thread M4		
	Part No.	560131	Ref. No. —
	hexagonal nut thread M4 H 3.2mm WS 7 SS DIN/ISO DIN 934 / ISO 4032/8673 Qty 20 pcs		

			
1			
Part No.	415033	Ref. No.	00003349 old version
description	heating element 9000W 230V heating circuits 3 L 322mm W 37mm H 68mm tube ø 6.3mm hole distance 67/45mm hole ø 10mm connection M4 4 hole flange immersion heater		
accessories for	415033		
	Part No.	510401	Ref. No. 00003430
	gasket rubber L 88mm W 73mm thickness 5mm hole ø 7mm hole distance 65mm for heating element 4 holes ID ø 50mm		
	Part No.	521103	Ref. No. —
	nut thread M4 H 3mm WS 7 brass Qty 20 pcs		
	Part No.	521104	Ref. No. —
	washer ID ø 4.3mm ED ø 8mm thickness 0.5mm brass Qty 20 pcs for thread M4		
	Part No.	560111	Ref. No. —
	plain washer ID ø 4.3mm ED ø 9mm thickness 0.8mm SS Qty 20 pcs DIN 125A for thread M4		
	Part No.	560131	Ref. No. —
	hexagonal nut thread M4 H 3.2mm WS 7 SS DIN/ISO DIN 934 / ISO 4032/8673 Qty 20 pcs		





			
1			
Part No.	420213	Ref. No.	00003335
description	heating element 9000W 240V heating circuits 3 L 483mm W 46mm H 40mm tube ø 8.5mm hole distance 65mm hole ø 9.5mm connection M4 4 hole flange immersion heater flange width 81mm flange length 96mm		
For models:	CE24, ETE20, ETE21, ETE25, ETE27, ETS15, LP130		
accessories for	420213		
	Part No.	510401	Ref. No. 00003430
	gasket rubber L 88mm W 73mm thickness 5mm hole ø 7mm hole distance 65mm for heating element 4 holes ID ø 50mm		

			
1			
Part No.	418879	Ref. No.	00003349
description	heating element 9800W 230V heating circuits 3 L 322mm W 37mm H 68mm number of thermostat sleeves 2 thermostat sleeves ø 6.5/10mm length thermostat sleeves 185/80mm tube ø 6.3mm hole distance 65/45mm hole ø 10mm connection M4 4 hole flange immersion heater flange width 81mm flange length 96mm		
For models:	120, 160, 240, 885, 904, 906, 908, 912, C33, C34, C34dgt, C44, C44dgt, C44dgt-elt, C66, C66dgt, C66dgt-elt, C77, CW650-15, CW650-16, CW650-35, CW650-36, D120, D120dgt, D30, D40, D40ELT, D40ELT-BTBA, D40i, D40i-BT-BA, D40i-ELT-BT-BA, D45, D80, D80F, D85, EN, ET, ET020, ETA, ETE20, ETE21, ETE25, ETE27, ETS15, LP130, LP60, LP60H, LP61, LP61H, LP70		
accessories for	418879		
	Part No.	510401	Ref. No. 00003430
	gasket rubber L 88mm W 73mm thickness 5mm hole ø 7mm hole distance 65mm for heating element 4 holes ID ø 50mm		









1 1/4"			
			
1			
Part No.	415153	Ref. No.	00002430 00003251 00003270 00003271
description	heating element 5700W 230V heating circuits 3 thread 1 1/4" L 300mm W 85mm H 42mm L1 120mm L2 180mm W1 29mm W2 28mm H1 21mm H2 21mm tube ø 6.3mm connection male faston 6.3mm connection length 40mm flange with thread immersion heater		
For models:	120, 160, 240, 882, 885, 904, 906, 908, 912, C33, C44, C44dgt, C44dgt-elt, C66, C66dgt, C66dgt-elt, C77, D120, D120dgt, D35, D36, D40, D40ELT, D40ELT-BT-BA, D40i, D40i-ELT-BT-BA, D45, D80, D80F, D85, LP60, LP60H, LP61, LP61H, LP70		
spare parts for	415153		
	Part No.	510405	Ref. No. —
	flat gasket fibre ED ø 56mm ID ø 42mm thickness 2mm for thread 1 1/4" Qty 1 pcs		
accessories for	415153		
	Part No.	520232	Ref. No. —
	nut thread 1 1/4" H 5mm nickel-plated brass WS 47 Qty 1 pcs		
	Part No.	528021	Ref. No. —
	flat gasket PTFE ED ø 53mm ID ø 42.5mm thickness 3mm Qty 1 pcs equiv. no. 12001/02286 suitable for Astoria/Aurora/Brasilia/Wega		





			
1			
Part No.	418981	Ref. No.	00003277
description	heating element 1000/1300/1400W 200/230/240V heating circuits 1 L 213mm W 67mm H 29mm thread 1/4" mounting distance 61mm tube ø 6.3mm connection male faston 6.3mm immersion heater		
For models:	BD46, BD47, BE35, BE40		

			
1			
Part No.	416281	Ref. No.	00203091
description	heating element 2000W 230V heating circuits 1 L 300mm W 76mm H 30mm thread 1/4" mounting distance 80mm tube ø 6.3mm connection male faston 6.3mm 2 hole fixing connection length 15mm immersion heater		
For models:	B11, B15, BD11, BD13, BD14, BD14alt, BD22, BD46, BD47, D30, D35, D36, D40, D40ELT, D40ELT-BT-BA, D40i, D40i-ELT-BT-BA		
spare parts for	416281		
	Part No.	510417	Ref. No. —
	flat gasket fibre ED ø 20mm ID ø 14mm thickness 2mm Qty 1 pcs		
accessories for	416281		
	Part No.	361182	Ref. No. —
	nut thread 1/4" H 5mm nickel-plated brass WS 17 Qty 1 pcs		
	Part No.	520228	Ref. No. —
	tooth lock washer ID ø 15.3mm ED ø 24mm steel Qty 1 pcs for thread M14		

accessories for	416281		
	Part No.	550262	Ref. No. —
	flat gasket copper ED ø 20mm ID ø 14mm thickness 2mm		

			
1			
Part No.	415176	Ref. No.	00203089
description	heating element 2700W 230V heating circuits 1 L 350mm W 70mm thread 1/4" mounting distance 64mm tube ø 6.25mm 2 hole fixing immersion heater connection male faston 6.3mm		
For models:	42, 42E, 48, 48E, 55, 55E, 60		

			
1			
Part No.	416282	Ref. No.	00018070
description	heating element 3200W 230V heating circuits 1 L 350mm W 77mm H 33mm thread 1/4" mounting distance 71mm tube ø 6.3mm connection male faston 6.3mm 2 hole fixing immersion heater		
For models:	882, 885, BD50, BE50, BE50T, C33, C34, C34dgt, C44, C44dgt-elt, C66, C77, CE24, D120, D120dgt, D80, D80F, D85, LP60, LP60H		
spare parts for	416282		
	Part No.	510417	Ref. No. —
	flat gasket fibre ED ø 20mm ID ø 14mm thickness 2mm Qty 1 pcs		
accessories for	416282		
	Part No.	361182	Ref. No. —
	nut thread 1/4" H 5mm nickel-plated brass WS 17 Qty 1 pcs		
	Part No.	520228	Ref. No. —
	tooth lock washer ID ø 15.3mm ED ø 24mm steel Qty 1 pcs for thread M14		
	Part No.	550262	Ref. No. —
	flat gasket copper ED ø 20mm ID ø 14mm thickness 2mm		

Part No.	416282	Ref. No.	00018070
description	heating element 3200W 230V heating circuits 1 L 350mm W 77mm H 33mm thread 1/4" mounting distance 71mm tube ø 6.3mm connection male faston 6.3mm 2 hole fixing immersion heater		
For models:	882, 885, BD50, BE50, BE50T, C33, C34, C34dgt, C44, C44dgt-elt, C66, C77, CE24, D120, D120dgt, D80, D80F, D85, LP60, LP60H		
spare parts for	416282		
	Part No.	510417	Ref. No. —
	flat gasket fibre ED ø 20mm ID ø 14mm thickness 2mm Qty 1 pcs		
accessories for	416282		
	Part No.	361182	Ref. No. —
	nut thread 1/4" H 5mm nickel-plated brass WS 17 Qty 1 pcs		
	Part No.	520228	Ref. No. —
	tooth lock washer ID ø 15.3mm ED ø 24mm steel Qty 1 pcs for thread M14		
	Part No.	550262	Ref. No. —
	flat gasket copper ED ø 20mm ID ø 14mm thickness 2mm		

thermostats

bi-metal thermostats

safety bi-metal thermostats

			
1			
Part No.	390748	Ref. No.	22110020
description	bi-metal safety thermostat hole distance 23.5mm switch-off temp. 100°C 1NC 1-poleA connection F6.3		
For models:	42, 42E, 48, 48E, 55, 55E, 60, 882, B11, B15, BD11, BD13, BD14, BD14alt, BD22, BE35, BE40, D30		

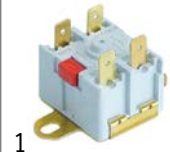

Part No.	390681	Ref. No.	22110021
description	bi-metal safety thermostat hole distance 40mm switch-off temp. 105°C 2NC 2-pole 16A 250V connection F6.3		
For models:	BE35, BE40, BE50		

Part No.	375757	Ref. No.	22110020 old version
description	bi-metal safety thermostat switch-off temp. 100°C 1NC 1-pole 16A connection F6.3		

bi-metal thermostats



Part No.	390909	Ref. No.	22180101
description	bi-metal thermostat hole distance 46mm switch-off temp. 56°C 1NC 1-pole 16A 250V connection F6.3 Qty 1 pcs		
For models:	BE35, BE40		

control and safety thermostats

EGO

control thermostats

55.10/19_ series



Part No.	390779	Ref. No.	22140003 22140004
description	thermostat t.max. 190°C temperature range 105-190°C 1-pole 1NO 0.5A probe ø 4mm probe L 235mm capillary pipe 1470mm capillary pipe isolated 1250mm gland nut M10x1 shaft ø 6x4.6mm shaft L 23mm shaft position lower rotation 270°		
For models:	ES12, ES20, ESD12, ESD20, GSDT12, GSDT20, GST12, GST20, GW209T, GWD209T, GWDT12, GWDT20, GWT12, GWT20, ST12, ST12+12, ST7, ST7+7		



Part No.	390731	Ref. No.	22140002
description	thermostat t.max. 195°C temperature range 65-195°C 1-pole 1NO 16A probe ø 4mm probe L 106mm capillary pipe 1470mm capillary pipe isolatedmm gland nut shaft ø 6x4.6mm shaft L 23mm shaft position° shaft position upper rotation 270°		
For models:	GSDT12, GSDT20, GST12, GST20, GVM35T, GWDT12, GWDT20, GWT12, GWT20, ST12, ST12+12, ST4, ST6, ST7, ST7+7		

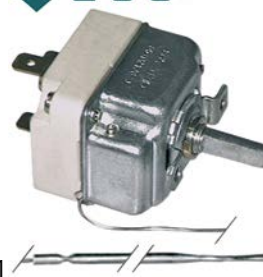

Part No.	390174	Ref. No.	00003323 22140001
description	thermostat t.max. 204°C temperature range 65-204°C 1-pole 1NO 16A probe ø 4mm probe L 89mm capillary pipe 600mm capillary pipe isolatedmm gland nut shaft ø 6x4.6mm shaft L 23mm shaft position upper rotation 270° probe material SS		
For models:	EB12, EB12+12, EB18P, EB6, EB6+6, EB8, EM12, EM12+12, EM20, EM20+20, EM20+20-900, EM20-900, EM240, EM35, EM360, EM40-900, EM480, EM612, ES12, ES20, ESD12, ESD20, FE12, FE20, FE20+20, FE30, FE30+30, KES20, KESD20		

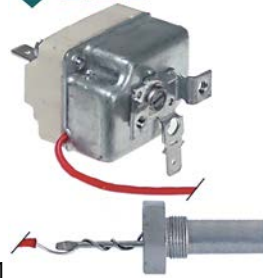

Part No.	390172	Ref. No.	0000317a 00057151 22110002
description	thermostat t.max. 50°C temperature range fixed 50°C 1-pole 1CO 16A probe ø 11mm probe L 45mm capillary pipe 850mm capillary pipe isolated 830mm gland nut shaft Lmm shaft position screw-in probe probe thread 3/8"		
For models:	120, 160, 240, 42, 42E, 48, 48E, 55, 55E, 60, 882, 885, 904, 906, 908, 912, B11, B15, BD11, BD13, BD14, BD14alt, BD22, BD46, BD47, BD50, BE50, BE50T, C33, C34, C34dgt, C44, C44dgt, C44dgt-elt, C66, C66dgt, C66dgt-elt, C77, CW650-15, CW650-16, CW650-35, CW650-36, D120, D120dgt, D30, D35, D36, D40, D40i, D45...(Other models you can see in the webshop)		
accessories for	390172		
	Part No.	506024	Ref. No. —
			nut thread 3/8" H 6mm SS WS 22 Qty 1 pcs

Table continues overleaf



accessories for	390172		
	Part No.	521137	Ref. No.
			—



Part No.	375534	Ref. No.	22180004
description	thermostat t.max. 90°C temperature range 19-90°C 1-pole 1CO 16A probe Ø 6mm probe L 129mm capillary pipe 980mm capillary pipe isolated 960mm gland nut shaft Lmm shaft position rotation 180°		
For models:	B11, B15, BD11, BD13, BD14, BD14alt, BD22, BD46, BD47, BD50, BE35, BE40, BE50, BE50T, C33, C34, C34dgt, C44, C44dgt, C44dgt-elt, C66, C66dgt, C66dgt-elt, C77, CE24, CW650-15, CW650-16, CW650-35, CW650-36, D120, D120dgt, D30, D35, D36, D40, D40i, D40i-BT-BA, D45, D80, D80F, D85, ETE20, ETE21, ETE25, ETE27, LP60, LP60H, LP61, LP61H, LP70		

55.34_ series



Part No.	390057	Ref. No.	00033240 22160001
description	thermostat t.max. 192°C temperature range 100-192°C 3-pole 3NO 16A probe Ø 7mm probe L 200mm capillary pipe 870mm capillary pipe isolatedmm gland nut shaft Ø 6x4.6mm shaft L 23mm shaft position upper° rotation 270°		
For models:	EB12, EB12+12, EB18P, EB6, EB6+6, EB8, EM12, EM12+12, EM20, EM20+20, EM20+20-900, EM20-900, EM35, EM40-900, ES12, ESD12		

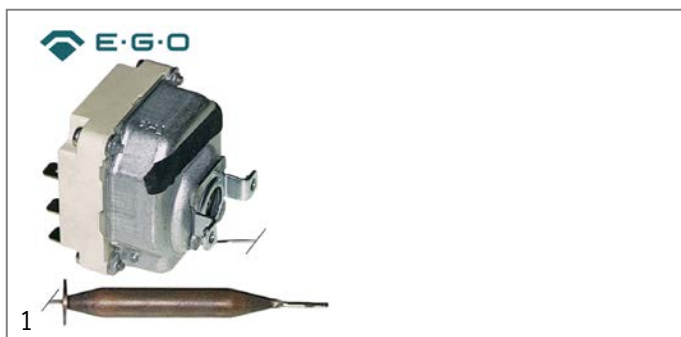

Part No.	390043	Ref. No.	00003190
description	thermostat t.max. 80°C temperature range fixed 80°C capillary pipe isolatedmm gland nut		



Part No.	390042	Ref. No.	00003190 0000319A 22190001
description	thermostat t.max. 85°C temperature range 35-85°C 3-pole 3CO 16A probe Ø 9.5mm probe L 80mm capillary pipe 870mm capillary pipe isolatedmm gland nut shaft Ø 6x4.6mm shaft L 23mm shaft position upper° rotation 180° with disc disc Ø 10mm		

safety thermostats

55.10/19_ series



Part No.	390738	Ref. No.	22180100
description	safety thermostat switch-off temp. 107°C 1-pole 1NC 16A probe Ø 6mm probe L 77mm capillary pipe 1170mm capillary pipe isolated 1150mm gland nut probe probe material SS		
For models:	EN, ET, ET020, ETA, LPE100, LPE145		

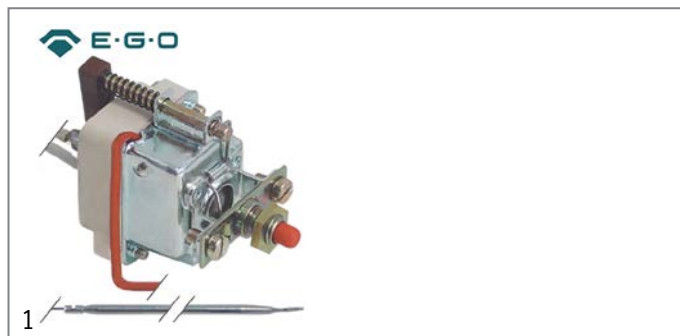

Part No.	375178	Ref. No.	22170001
description	safety thermostat switch-off temp. 230°C 1-pole 0.5A probe Ø 4mm probe L 116mm capillary pipe 1500mm capillary pipe isolatedmm gland nut probe SS		
For models:	FG125, FG12M, FG157, FG159, FG24M, FG307, FG309, GB10, GBD10, GM12, GM12+12, GM20+20, GM20+20-900, GM25+25-900, GM2532, GM2542, GM25-900, GM35, GM50-900, GMD2532, GMD2542, GSdT12, GSdT20, GST12, GST20, GVM35, GVM35T, GW12, GW20, GWD12, GWD20, GWDT12, GWDT20, GW-MODULARI, GWT12, GWT20		



E-G-O



Part No.	390730	Ref. No.	161142 22170003
description	safety thermostat switch-off temp. 230°C 1-pole 0.5A probe ø 4mm probe L 125mm capillary pipe 1550mm capillary pipe isolated 1410mm gland nut probe		
For models:	FG12M, FG24M, GB10, GBD10, GSDT12, GSDT20, GST12, GST20, GVM35T, GW12ELT, GW209T, GW20ELT, GWD12ELT, GWD209T, GWD20ELT, GWDT12, GWDT20, GWT12, GWT20		

55.14_ series

E-G-O



Part No.	390176	Ref. No.	00003227 22130001
description	safety thermostat switch-off temp. 230°C 1-pole 16A probe ø 6mm probe L 74mm capillary pipe 600mm capillary pipe isolatedmm gland nut probe SS		
For models:	EB12, EB12+12, EB18P, EB6, EB6+6, EB8, EM12, EM12+12, EM20, EM20+20, EM20+20-900, EM20-900, EM35, EM40-900		

55.31_ series

E-G-O



Part No.	390091	Ref. No.	22150001
description	safety thermostat switch-off temp. 230°C 3-pole 20A probe ø 6mm probe L 239mm capillary pipe 830mm capillary pipe isolatedmm gland nut probe SS 380V		
For models:	EB12, EB12+12, EB18P, EB6, EB6+6, EB8, EM12, EM12+12, EM20, EM20+20, EM20+20-900, EM20-900, EM35, EM40-900, FE12, FE20, FE20+20, FE30, FE30+30		

55.32_ series

E-G-O

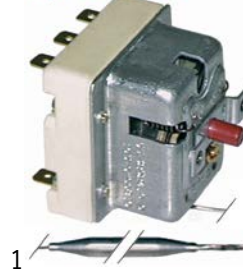

Part No.	390178	Ref. No.	22100002
description	safety thermostat switch-off temp. 124°C 3-pole 20A probe ø 6mm probe L 74mm capillary pipe 900mm capillary pipe isolated 900mm gland nut probe SS		
For models:	120, 160, 240, 882, 885, 904, 906, 908, 912, C33, C34, C34dgt, C44, C44dgt, C44dgt-elt, C66, C66dgt, C66dgt-elt, C77, CE24, D120, D120dgt, D30, D35, D36, D40, D40ELT, D40ELT-BT-BA, D40i, D40i- BTBA, D45, D80, D80F, D85, EN, ET, ET020, ETA, ETE20, ETE21, ETE25, ETE27, ETS15, LP130, LP60, LP60H, LP61, LP61H, LP70, SQ885...(Other models you can see in the webshop)		

55.33_ series

E-G-O



Part No.	375796	Ref. No.	00032280 22150002 22150003
description	safety thermostat switch-off temp. 220°C 3-pole 3NC 20A probe ø 6mm probe L 107mm capillary pipe 870mm capillary pipe isolated 800mm gland nut probe		
For models:	EB12, EB12+12, EB8, EM12, EM12+12, EM20, EM20+20, ES12, ES20, ESD12, ESD20, KES20, KESD20, ST12, ST12+12, ST7, ST7+7		

56_ series

E-G-O





Part No.	390714	Ref. No.	00032270
description	safety thermostat switch-off temp. 230°C 1-pole 1NC 16A probe ø 6mm probe L 75mm capillary pipe 740mm capillary pipe isolated 200mm gland nut probe SS		
For models:	EB6, EB6+6, ES20, ESD20, KES20, KESD20, ST4, ST6		



IMIT / TEMPOMATIC / ARTHERMO

control thermostats



Part No.	390173	Ref. No.	00003170 00057150
description	thermostat t.max. 87°C temperature range 27-87°C 1-pole 1CO 15A probe ø 6.5mm probe L 95mm capillary pipe 1000mm capillary pipe isolated 1000mm gland nut shaft ø 6x4.6mm shaft L 19mm rotation 270° with disc disc ø 14.5mm		
For models:	120, 160, 240, 42, 42E, 48, 48E, 55, 55E, 60, 882, 885, 904, 906, 908, 912, C33, C44, C66, D120, EN, ET, ET020, ETA, LP130, LP60, LP70, LPE100, LPE145, SQ885, SQT80		
accessories for	390173		
	Part No.	110100	Ref. No. —
	knob thermostat t.max. 90°C 0-90°C ø 42mm shaft ø 6x4.6mm shaft flat -135° black		
	Part No.	110310	Ref. No. —
	rosette knob up to ø 45mm		

safety thermostats



Part No.	375850	Ref. No.	22130002
description	safety thermostat switch-off temp. 230°C 1-pole 1NC 15A probe ø 3.5mm probe L 200mm capillary pipe 950mm capillary pipe isolatedmm gland nut probe SS 250V		
For models:	EM20, EM20+20, ES20, ESD20, KES20, KESD20, ST12, ST12+12		



Part No.	375851	Ref. No.	00032610
description	safety thermostat switch-off temp. 230°C 1-pole capillary pipe isolatedmm gland nut probe		

various

control thermostats

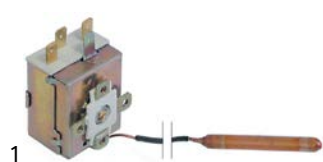

Part No.	390196	Ref. No.	22180004 old version
description	thermostat t.max. 93°C temperature range 35-93°C 1-pole		

accessories

fitting parts

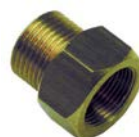

Part No.	511627	Ref. No.	00003400
description	screw connection for boiler IT M16x1 ET 3/8"		
For models:	120, 160, 240, 42, 42E, 48, 48E, 55, 55E, 60, 882, 885, 904, 906, 908, 912, D30, LPE100, LPE145, SQ885, SQT80		

gland ducts



Part No.	551076	Ref. No.	00038680
description	gland duct ET M11x1 IT M10x1 probe ø max. 4mm WS 22 copper stainless steel L 30mm		
For models:	FG12M, FG24M, GB10, GBD10, GSDT12, GSDT20, GST12, GST20, GW209T, GWDT12, GWDT20, GWT12, GWT20		

plunger sockets



Part No.	550139	Ref. No.	00030500
description	thermowell thread 3/4" L 310mm SS double ø 8mm hole ø 7mm		
For models:	FG125, FG157, FG159, FG307, FG309, GM12, GM12+12, GM20+20, GM20+20-900, GM25+25-900, GM2532, GM2542, GM25-900, GM35, GM50-900, GMD2532, GMD2542, GVM35, GVM35T, GW12, GW20, GWD12, GWD20, GW-MODULARI		
accessories for	550139		
	Part No.	520234	Ref. No. —
	nut thread 3/4" H 5mm brass WS 30 Qty 1 pcs		

miscellaneous



Part No.	550268	Ref. No.	00032290
description	cover cap for push-button		
For models:	EB12, EB12+12, EB18P, EB6, EB6+6, EB8, EM12, EM12+12, EM20, EM20+20, EM20+20-900, EM20-900, EM35, EM40-900, ES12, ES20, ESD12, ESD20, FE12, FE20, FE20+20, FE30, FE30+30, KES20, KESD20		



switches and momentary switches

push/momentary push switches

17x13mm



1

Part No.	345950	Ref. No.	28160041
description	momentary push switch mounting measurements 17x13mm grey 2CO 250V 16A connection male faston 6.3mm ambient temperature max. 150/75°C protection IP40		
For models:	BD14, C33		

20.6x16.4mm



1

Part No.	345948	Ref. No.	28160038 28160039
description	momentary push switch mounting measurements 20.6x16.4mm grey 2CO 250V 16A outflow connection male faston 6.3mm ambient temperature max. 150°C protection IP40		
For models:	BD14, C33		



1

Part No.	345949	Ref. No.	28160040
description	push switch mounting ø 20.6x16.4mm grey 2CO 250V 16A connection male faston 6.3mm ambient temperature max. 150°C protection IP40		
For models:	BD14, C33		

28.5x28.5mm



1

Part No.	345940	Ref. No.	28160020
description	momentary push switch mounting measurements 28.5x28.5mm grey 2CO 240V 16A connection male faston 6.3mm ambient temperature max. 150°C protection IP40		
For models:	120, 160, 240, 42, 42E, 48, 48E, 55, 55E, 60, 882, 885, 904, 906, 908, 912, C44, C66, C77, LP130, LP60, LP60H, LP61, LP61H, LP70		



1

Part No.	345942	Ref. No.	28160024 28160273
description	push switch mounting measurements 28.5x28.5mm grey 2CO 250V 16A connection male faston 6.3mm ambient temperature max. 150°C protection IP40		
For models:	LP130, LP60, LP60H, LP61, LP61H, LP70		



1

Part No.	345953	Ref. No.	28160273
description	push switch mounting measurements 28.5x28.5mm grey 2CO 250V 16A connection male faston 6.3mm ambient temperature max. 150°C protection IP40		
For models:	C44, C66, C77		



1

Part No.	345943	Ref. No.	28160026 28160272
description	momentary push switch mounting measurements 28.5x28.5mm grey 2CO 250V 16A clock connection male faston 6.3mm ambient temperature max. 125/55°C protection IP40		
For models:	B11, B15, BD11, BD13, BD22, BD50, BE35, BE40, BE50, BE50T, D120, D30, D35, D40, D40ELT, D40i, D40i-BT-BA, D80, D80F		



1

Part No.	345941	Ref. No.	28160022
description	momentary push switch mounting measurements 28.5x28.5mm grey 2CO 250V 16A drain pump connection male faston 6.3mm ambient temperature max. 150°C protection IP40		
For models:	120, 160, 240, 42, 42E, 48, 48E, 55, 55E, 882, 885, 904, 906, 908, 912		



1

Part No.	345947	Ref. No.	28160037
description	momentary push switch mounting measurements 28.5x28.5mm grey 2CO 250V 16A drain pump connection male faston 6.3mm ambient temperature max. 150°C protection IP40		
For models:	C44, C66, C77, D120, D30, D40, D40ELT, D80, D80F		



1

Part No.	347990	Ref. No.	28160045
description	momentary push switch mounting measurements 28.5x28.5mm grey 2CO 250V 16A regeneration connection male faston 6.3mm		
For models:	D35, D40i		



28.5x77.5mm



1			
Part No.	345944	Ref. No.	28160028 28160034
description	switch combination latching mounting measurements 28.5x77.5mm grey 2CO/2CO/2CO 250V 16A main switch connection male faston 6.3mm ambient temperature max. 85°C protection IP40		
For models:	B11, B15, BD11, BD13, D30		

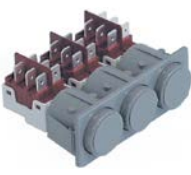

1			
Part No.	345954	Ref. No.	28160274
description	switch combination latching mounting measurements 28.5x77.5mm grey 2CO/2CO/2CO 250V 16A connection male faston 6.3mm ambient temperature max. 85°C protection IP40		
For models:	C44, C66, C77		



1			
Part No.	345945	Ref. No.	28160029 28160033
description	switch combination latching mounting measurements 28.5x77.5mm grey 2CO/2CO/2CO 250V 16A main switch/program/drain pump connection male faston 6.3mm ambient temperature max. 85°C protection IP40		
For models:	CE24, D35, D40, D40i, D40i-BT-BA		



1			
Part No.	345180	Ref. No.	28160021 28160023
description	switch combination mounting measurements 28.5x77.5mm grey 1CO/1CO/1CO 250V 16A connection male faston 6.3mm ambient temperature max. 85°C protection IP40		
For models:	120, 160, 240, 882, 885, 904, 906, 908, 912, C44, C66, LP130, LP60, LP60H, LP61, LP61H, LP70, SQ885, SQT80		



1			
Part No.	345946	Ref. No.	28160036
description	switch combination mounting measurements 28.5x77.5mm grey 2CO/2CO/2CO 250V 16A double arrow/arrow/main switch connection male faston 6.3mm ambient temperature max. 85°C protection IP40		
For models:	D120, D40ELT, D80, D80F		

miscellaneous



1			
Part No.	345951	Ref. No.	28160043
description	momentary push switch grey 2CO 250V 16A without frame drain connection male faston 6.3mm ambient temperature max. 85°C		
For models:	B11, BD11, BD13, BD22, BD50, BE35, BE40, BE50, BE50T		



1			
Part No.	345952	Ref. No.	28160044
description	momentary push switch grey 2CO 250V 16A without frame rinsing connection male faston 6.3mm ambient temperature max. 85°C		
For models:	B11, BD11, BD13, BD50, BE35, BE40		

microswitches

lever actuated



1			
Part No.	345183	Ref. No.	25190005
description	microswitch with double lever 250V 16A 2CO connection male faston 6.3mm L 50mm ambient temperature max. 125°C mounting distance 22.5mm type N16 actuating force: 290g lever length 47mm		
For models:	42, 42E, 48, 48E, 55, 60, C33, C44, C66, C77, CW650-15, CW650-16, CW650-35, CW650-36		



1			
Part No.	345178	Ref. No.	25190003
description	microswitch with lever 250V 16A 1CO connection male faston 6.3mm L 28mm L1 37mm ambient temperature max. 125°C mounting distance 22mm actuating force: 220g lever length 33mm		
For models:	120, 160, 240, 885, 904, 906, 908, 912, C44, C66, C77, D40i, D40i-BTBA, D40i-ELT-BT-BA, EB12, EB12+12, EB6, EB6+6, EB8, EM12, EM12+12, EM20, EM20+20, ES12, ES20, ESD12, ESD20, FE12, FE20, FE20+20, FE30, FE30+30, KES20, KESD20, ST12, ST12+12, ST7, ST7+7		



			
1			
Part No.	345255	Ref. No.	25190007
description	microswitch with lever 250V 16A 1CO connection male faston 6.3mm L 35mm L1 28mm ambient temperature max. 125°C mounting distance 22mm actuating force: 136g lever length 27mm		
For models:	B11, BD11, BD13, BD14, BD14alt, BD22, C34, C34dgt, C44, C44dgt, C44dgt-elt, C66, C66dgt, C66dgt-elt, C77, CE24, D30, D40, D40ELT, D40ELT-BT-BA, D80, D80F, EN, ST4, ST6		

roller-lever actuated

non-standard

			
1			
Part No.	345186	Ref. No.	00000639 00006390 25190001
description	microswitch with handle with a switch 250V 15A 1CO connection male faston 6.3mm L 42mm ambient temperature max. 85°C lever length 37mm		
For models:	120, 160, 240, 885, SQ885, SQT80		

accessories

			
1			
Part No.	511892	Ref. No.	00011115
description	actuator for microswitch kit		
For models:	885, 904, 906, 908, 912		

			
1			
Part No.	511081	Ref. No.	00011100
description	actuator microswitch		
For models:	42, 42E, 48, 48E, 55, 60		

			
1			
Part No.	511111	Ref. No.	00006410
description	actuator microswitch kit		

			
1			
Part No.	511119	Ref. No.	00011090
description	actuator microswitch kit		
For models:	120, 160, 240, SQ885, SQT80		

			
1			
Part No.	511112	Ref. No.	00006401 640H
description	lever for microswitch		
For models:	E500, MR600		

position switches

LOVATO

			
1			
Part No.	347579	Ref. No.	25190004
description	position switch plastic 1NO/1NC 400V 3A L 110mm W 30mm H 44mm protection IP66/67 actuating force: 380g screw connection M16 mounting distance 22mm type ZCP21		
For models:	ET, ETE20, ETE21, ETE25, ETE27, ETS15		

TELEMECANIQUE (EFA)

			
1			
Part No.	347579	Ref. No.	25190004
description	position switch plastic 1NO/1NC 400V 3A L 110mm W 30mm H 44mm protection IP66/67 actuating force: 380g screw connection M16 mounting distance 22mm type ZCP21		
For models:	ET, ETE20, ETE21, ETE25, ETE27, ETS15		

			
1			
Part No.	347903	Ref. No.	00073790 25190002
description	position switch plastic 1NO/1NC 400V 3A L 110mm W 30mm H 44mm protection IP66/67 actuating force: 380g screw connection M16 mounting distance 22mm type ZCP21		
For models:	D40i, D40i-ELT-BT-BA, EN, ET, ET020, ETA, LP100, LP145, LPE100, LPE145		

system switches (ROLD)

			
1			
Part No.	346233	Ref. No.	28160205 28160210 28160218 28160219
description	blank ø 23.3mm grey		
For models:	BD50, BE35, BE40, BE50, BE50T		





 <p>1</p>			
Part No.	347193	Ref. No.	28160250
description	momentary switch unit 1NO 250V 16A connection male faston 6.3mm		
For models:	BD14alt, BD50, BE35, BE40, BE50		

 <p>1</p>			
Part No.	346256	Ref. No.	28160214
description	push button ø 23mm grey clock no lens		
For models:	BD50, BE35, BE40, BE50, CE24		

 <p>1</p>			
Part No.	346255	Ref. No.	28160202
description	push button ø 23mm grey drain pump		
For models:	BE35, BE40, BE50		

 <p>1</p>			
Part No.	346253	Ref. No.	28160213
description	push button ø 23mm grey main switch		
For models:	BD50, BE35, BE40, BE50, CE24		

 <p>1</p>			
Part No.	345651	Ref. No.	28160253
description	switch 2CO 250V 16A connection male faston 6.3mm		

 <p>1</p>			
Part No.	347504	Ref. No.	28160275
description	switch 2CO 250V 16A connection male faston 6.3mm		
For models:	CE24		

rotary switches

BRETER

rotary switches

 <p>1</p>			
Part No.	345165	Ref. No.	25100102 old version
description	rotary switch 16A 2-pole		

 <p>1</p>			
Part No.	345015	Ref. No.	00005980
description	rotary switch 16A connection screw clamp 3-pole shaft 5x5mm		

 <p>1</p>			
Part No.	345166	Ref. No.	25120001 old version
description	rotary switch 4-pole		

TECNOMATIC

 <p>1</p>			
Part No.	345016	Ref. No.	0000597A 25100001
description	rotary switch 2 0-1 sets of contacts 1 type HD1201R000 600V 12A shaft ø 5x5mm shaft L 23mm shaft square connection screw		
For models:	EB12, EB12+12, EB18P, EB6, EB6+6, EB8, EM12, EM12+12, EM20, EM20+20, EM20+20-900, EM20-900, EM35, EM40-900, ES12, ES20, ESD12, ESD20, FE12, FE20, FE20+20, FE30, FE30+30, KES20, KESD20, ST12, ST12+12, ST7, ST7+7		

 <p>1</p>			
Part No.	347055	Ref. No.	25100102
description	rotary switch 2 0-1 sets of contacts 2 type HD1602R000 600V 16A shaft ø 5x5mm shaft L 23mm shaft square connection screw		
For models:	120, 160, 240, 42, 42E, 48, 48E, 55, 55E, 60, 882, 885, 904, 906, 908, 912, C44, C66, CW650-15, CW650-16, CW650-35, CW650-36, SQ885, SQT80		



magnetic switches

36x13mm



1

Part No.	345955	Ref. No.	25110113
description	magnetic switch L 36mm W 13mm connection cable		
For models:	42, 42E, 48, 48E, 55, 55E, 882, 885, B11, B15, BD46, BD47, BD50, BE35, BE40, BE50, BE50T, D120, D120dgt, D30, D35, D36, D45, D85, ETE20, ETE21, ETE25, ETE27, ETS15, LP60, LP60H, LP61, LP61H		

65x20mm

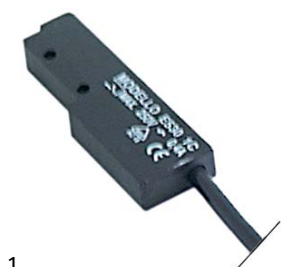

1

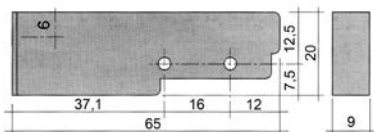

Part No.	345116	Ref. No.	25240003
description	magnetic switch L 65mm W 20mm 1NO 250V 0.4A P max. 100W connection cable cable length 3000mm		
For models:	EN, ET, ETQ20, ETA, ETE20, ETE21, ETE25, ETE27, LP130, LP70, LPE100, LPE145		
accessories for	345116		
	Part No.	345399	Ref. No. —
	magnet \varnothing 3.3mm L 40mm H 8mm W 13mm hole distance 30mm M3		

accessories

magnets

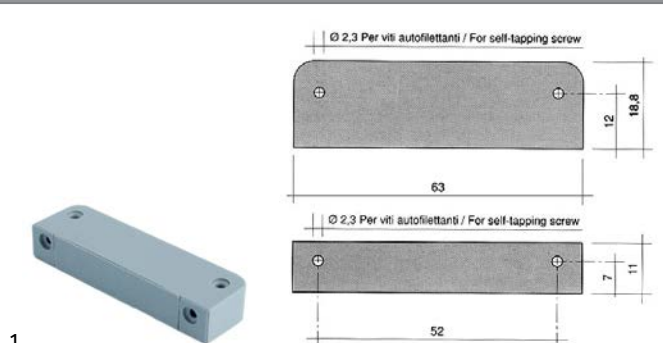

1

Part No.	519049	Ref. No.	25110115
description	magnet \varnothing mm L 63mm H 10.7mm W 18.8mm hole distance 52mm M2 hole \varnothing 2mm		
For models:	ETE20, ETE21, ETE25, ETE27, ETS15		
accessories for	519049		
	Part No.	560095	Ref. No. —
	sheet metal screws \varnothing 2.9mm L 9.5mm SS Qty 20 pcs DIN 7981/ISO 7049 head \varnothing 5.6mm oval head		

miscellaneous



1

Part No.	347904	Ref. No.	00065606
description	holding plate L 62mm W 26mm for magnetic switch		
For models:	LP60, LP60H, LP61, LP61H		

control equipment

TELEMECANIQUE (EFA)

ZB4 series

switches (complete)



1

Part No.	346925	Ref. No.	00061070
description	rotary selector mounting measurements \varnothing 22mm latching white illuminated rotation 90° sequence 0-1		
For models:	EN, ET, ETQ20, ETA, ETE20, ETE21, ETE25, ETE27, ETS15, LPE100, LPE145		
spare parts for	346925		
	Part No.	347385	Ref. No. —
	contact block EFA ZBE-101 1NO max 230V 10(6)A black		



			
1			
Part No.	347905	Ref. No.	00061060
description	rotary selector mounting measurements ø22mm latching white illuminated sequence 0-1		
For models:	ETS15, LP130, LP60, LP60H, LP61, LP61H, LP70		

lamps

indicator lights

indicator lights 3-piece (housing, lens and bulb)

lamps

light bulbs

			
1			
Part No.	359236	Ref. No.	00006460 28130003
description	light bulb socket E10 24V 3W ø 10mm L 28mm		

indicator lights (complete)

ø 6mm

			
1			
Part No.	359005	Ref. No.	28100006
description	indicator light ø 6mm 230V yellow cable length 400mm		
For models:	120, 160, 240, 42, 42E, 48, 48E, 55, 55E, 60, 882, 885, 904, 906, 908, 912, C44, C66, CW650-15, CW650-16, CW650-35, CW650-36, SQ885, SQT80		

ø10mm

with plug-in socket

			
1			
Part No.	359140	Ref. No.	28100007
description	indicator light ø 10mm yellow 230V connection male faston 6.3mm Qty 1 pcs		
For models:	120, 160, 240, 42, 42E, 48, 48E, 55, 55E, 60, 882, 885, 904, 906, 908, 912, B11, B15, C44, C66, LP70, SQ885, SQT80		



ø12mm



with screw socket

			
1			
Part No.	359048	Ref. No.	28110100 28110101
description	indicator light ø 12mm 230V yellow connection male faston 6.3mm		
For models:	D35, D40ELT, D40i, D40i-BT-BA		

ø13mm

with screw socket

			
1			
Part No.	359146	Ref. No.	28100011
description	indicator light ø 13mm 230V yellow		
For models:	B11, BD11, BD13, BD14, BD14alt, BD22, BD50, BE35, BE40, BE50, BE50T, C33, C34, C34dgt, C44, C66, C77, CE24, CW650-15, CW650-16, CW650-35, CW650-36, D120, D30, D35, D36, D40, D40i, D40i-BT-BA, D45, D80, D80F, LP130, LP60, LP60H, LP61, LP61H		
accessories for	359146		
		Part No. 510302	Ref. No. —
		O-ring EPDM ID ø 12.42mm thickness 1.78mm Qty 1 pcs	
		Part No. 511505	Ref. No. —
		O-ring EPDM thickness 1.78mm ID ø 12.42mm Qty 10 pcs	

			
1			
Part No.	359049	Ref. No.	28100001
description	indicator light ø 13mm 400V green		
accessories for	359049		
		Part No. 510302	Ref. No. —
		O-ring EPDM ID ø 12.42mm thickness 1.78mm Qty 1 pcs	
		Part No. 511505	Ref. No. —
		O-ring EPDM thickness 1.78mm ID ø 12.42mm Qty 10 pcs	

with plug-in socket

			
1			
Part No.	359119	Ref. No.	28100004
description	indicator light ø 13mm green 24V connection male faston 6.3mm Qty 1 pcs		



33x10mm



1

Part No.	359452	Ref. No.	00003320 28110001 28110001 + 00038828
description	indicator light mounting measurements 33.1x10.3mm 400V green connection male faston 6.3mm		
For models:	120, 160, 240, 882, 885, EB12, EB12+12, EB18P, EB6, EB6+6, EB8, EM12, EM12+12, EM20, EM20+20, EM20+20-900, EM20-900, EM35, EM40-900, ES12, ES20, ESD12, ESD20, FE12, FE20, FE20+20, FE30, FE30+30, KES20, KESD20, SQ885, SQT80		



1

Part No.	359451	Ref. No.	00003321 28110002 28110002 + 00038828
description	indicator light mounting measurements 33.1x10.3mm 400V yellow connection male faston 6.3mm		
For models:	EB12, EB12+12, EB18P, EB6, EB6+6, EB8, EM12, EM12+12, EM20, EM20+20, EM20+20-900, EM20-900, EM35, EM40-900, ES12, ES20, ESD12, ESD20, FE12, FE20, FE20+20, FE30, FE30+30, KES20, KESD20		

miscellaneous



1

Part No.	357123	Ref. No.	28100014
description	indicator light red 230V connection cable ø 8mm		
For models:	ST12, ST12+12, ST4, ST6, ST7, ST7+7		

screw-on/push-on fit

light bulbs

for indicator lights



1

Part No.	359236	Ref. No.	00006460 28130003
description	light bulb socket E10 24V 3W ø 10mm L 28mm		

timers

programme timers



1

Part No.	360654	Ref. No.	26100024
description	timer CDC 11804F1 engines 1 chambers 4 operation time 120s 230V shaft ømm shaft Lmm		
For models:	B11, BD11, BD13, BD14, BD14alt, BD22, BE35, BE40		



1

Part No.	360653	Ref. No.	26100023
description	timer CDC 11804F1 engines 1 chambers 4 operation time 180s 230V		
For models:	BD50, BE50, BE50T, D30		



1

Part No.	360671	Ref. No.	26100021
description	timer CDC 4905DV engines 2 chambers 5 operation time 72s / 4.8min 230V shaft ømm shaft Lmm		
For models:	C33, C44, C66, C77, D120, D40, D80, D80F		



1

Part No.	360069	Ref. No.	26100017
description	timer CROUZET engines 1 chambers 4 operation time 120s 230V shaft ømm shaft Lmm manif. no. 645/5245 motor type 82340		
For models:	42, 42E, 48, 48E, 55, 55E, B11, B15		





1

Part No.	360068	Ref. No.	26100019
description	timer CROUZET engines 1 chambers 5 operation time 90s 230V shaft ømm shaft Lmm manuf. no. 645/5238 motor type 82340		
For models:	120, 160, 240, 882, 885, 904, 906, 908, 912, SQ885, SQT80		





1

Part No.	360081	Ref. No.	00005930 26100015
description	timer FIBER P25 engines 1 chambers 4 operation time 120s 24V shaft ø 5x5mm shaft L 20mm manuf. no. P255204H313 motor type M51B20L6400		
spare parts for	360081		
	Part No.	360676	Ref. No. —
	motor kit pinion ø 6.8mm teeth 15 24V voltage AC 50/60Hz turn direction counterclockwise motor ø 48mm H 18.5mm motor type UDS40NE1RNZ165 cable length 150mm with holder		





1

Part No.	360304	Ref. No.	26100022
description	timer FIBER P25 engines 2 chambers 4 operation time 2min / 7.5min 230V shaft ømm shaft Lmm manuf. no. P255J04LXP8 motor type M51BJOR6400 / M51BJOL6400		
For models:	LP130, LP60, LP60H, LP61, LP61H, LP70		
spare parts for	360304		
	Part No.	360673	Ref. No. —
	motor kit pinion ø 6.8mm teeth 15 230V voltage AC 50/60Hz turn direction clockwise motor ø 48mm H 18.5mm motor type UDS-40NE1RNZ165 cable length 150mm with holder		
	Part No.	360674	Ref. No. —
	motor kit pinion ø 6.8mm teeth 15 230V voltage AC 50/60Hz turn direction counterclockwise motor ø 48mm H 18.5mm motor type UDS40NE1RNZ165 cable length 150mm with holder		



1

Part No.	360303	Ref. No.	26100021 (old version)
description	timer FIBER P25 engines 2 chambers 5 operation time 72s / 4.8min 230V shaft ømm shaft Lmm manuf. no. P255J05ANM0 motor type M51BJOR6400 / M51BJOL6400		
spare parts for	360303		
	Part No.	360673	Ref. No. —
	motor kit pinion ø 6.8mm teeth 15 230V voltage AC 50/60Hz turn direction clockwise motor ø 48mm H 18.5mm motor type UDS-40NE1RNZ165 cable length 150mm with holder		
	Part No.	360674	Ref. No. —
	motor kit pinion ø 6.8mm teeth 15 230V voltage AC 50/60Hz turn direction counterclockwise motor ø 48mm H 18.5mm motor type UDS40NE1RNZ165 cable length 150mm with holder		



1



Part No.	360203	Ref. No.	26100011
description	timer FIBER P26 engines 1 chambers 3 operation time 20min 230V shaft ømm shaft Lmm manuf. no. P265J03L103 motor type M61B40R6400		





1

Part No.	360087	Ref. No.	26100011
description	timer FIBER P26 engines 1 chambers 3 operation time 20min 230V shaft ømm shaft Lmm manuf. no. P265J03L130 motor type M61B40R6400		



			
1			
Part No.	360305	Ref. No.	26100025
description	timer FIBER PWE engines 1 chambers 1 operation time 20min 230V shaft ømm shaft Lmm manif. no. PWE5J01L103 motor type M51BJ0R6400		
For models:	B11, BD11, BD13, BD14, BD14alt, BD22, BD50, BE35, BE40, BE50, BE50T		
spare parts for	360305		
	Part No.	360673	Ref. No. —
	motor kit pinion ø 6.8mm teeth 15 230V voltage AC 50/60Hz turn direction clockwise motor ø 48mm H 18.5mm motor type UDS-40NE1RNZ165 cable length 150mm with holder		

			
1			
Part No.	360300	Ref. No.	26100024 (old version)
description	timer FIBER PWE engines 1 chambers 4 operation time 120s 230V shaft ømm shaft Lmm manif. no. PWE5J04302 motor type M51BJ0R6400		
spare parts for	360300		
	Part No.	360673	Ref. No. —
	motor kit pinion ø 6.8mm teeth 15 230V voltage AC 50/60Hz turn direction clockwise motor ø 48mm H 18.5mm motor type UDS-40NE1RNZ165 cable length 150mm with holder		

contactors

GENERAL ELECTRIC (AEG)

power contactors

			
1			
Part No.	380245	Ref. No.	25130028
description	power contactor resistive load 25A 230VAC (AC3/400V) 9A/4kW main contacts 3NO auxiliary contacts 1NC connection screw connection type AEG LS4K 01A type GE CL00A 301 H 85mm		
For models:	EB12, EB12+12, EB18P, EB6, EB6+6, EB8, EM12, EM12+12, EM20, EM20+20, EM20+20-900, EM20-900, EM35, EM40-900, SQ885, SQT80		

			
1			
Part No.	380244	Ref. No.	0000 25130028 25130031
description	power contactor resistive load 25A 230VAC (AC3/400V) 9A/4kW main contacts 3NO auxiliary contacts 1NO connection screw connection type AEG LS4K 10A type GE CL00A 310		

			
1			
Part No.	380262	Ref. No.	25130026
description	power contactor resistive load 32A 230VAC (AC3/400V) 17A/7.5kW main contacts 3NO auxiliary contacts 1NC connection screw connection type AEG LS7K01A type GE CL02A 301 H 85mm		
For models:	EM12, EM12+12, EM20, EM20+20, EM20+20-900, EM20-900, EM35, EM40-900, SQ885, SQT80		

			
1			
Part No.	380261	Ref. No.	25130025
description	power contactor resistive load 32A 230VAC (AC3/400V) 17A/7.5kW main contacts 3NO auxiliary contacts 1NO connection screw connection type AEG LS7K 10A type GE CL02A 310		
For models:	EM12, EM12+12, EM20, EM20+20, EM20+20-900, EM20-900, EM35, EM40-900		



LOVATO

power contactors



1

Part No.	380083	Ref. No.	25130037
description	power contactor resistive load 25A 230VAC (AC3/400V) 9A/4.2kW main contacts 3NO auxiliary contacts 1NC connection screw connection type BF0901A230		
For models:	BE50T, C44dgt, C44dgt-elt, C66dgt, C66dgt-elt, CE24, D36, D45, ES12, ESD12, ST12, ST12+12, ST7, ST7+7		



1

Part No.	380717	Ref. No.	25130038
description	power contactor resistive load 32A 230VAC (AC3/400V) 18A/7.5kW main contacts 3NO auxiliary contacts 1NC connection screw connection type BF1801A230		
For models:	D36, D45, ES12, ES20, ESD12, ESD20, ST12, ST12+12		



1

Part No.	380617	Ref. No.	00060670
description	power contactor resistive load 25A 24VAC (AC3/400V) 9A/4kW main contacts 3NO auxiliary contacts 1NO/1NC connection screw connection type LC1D09B7		
For models:	Cybergel, EN, ET, ET020, ETA, ETE20, ETE21, ETE25, ETE27, ETS15		



1

Part No.	380976	Ref. No.	00000627 00006270
description	power contactor resistive load 32A 230VAC (AC3/400V) 18A/7.5kW main contacts 3NO auxiliary contacts 1NO/1NC connection screw connection		
For models:	C44dgt, C44dgt-elt, C66dgt, C66dgt-elt, D120dgt, D36, D45, D85, EB12, EB12+12, EM12, EM12+12, EM20, EM20+20, ES12, ES20, ESD12, ESD20, ETS15, FE20, FE20+20, FE30, FE30+30, KES20, KESD20, LP130, LP60, LP60H, LP61, LP61H, LP70		

TELEMECANIQUE (Schneider Electric)

power contactors



1

Part No.	380820	Ref. No.	00000628 00006280
description	power contactor resistive load 25A 230VAC (AC3/400V) 9A/4kW main contacts 3NO auxiliary contacts 1NO/1NC connection screw connection type LC1D0900M7		
For models:	120, 160, 240, 882, 885, C33, C34, C34dgt, C44, C44dgt, C44dgt-elt, C66, C66dgt, C66dgt-elt, C77, CW650-15, CW650-16, CW650-35, CW650-36, D120, D120dgt, D30, D35, D36, D40, D40ELT, D40i, D40i-BT-BA, D40i-ELT-BT-BA, D45, D80, D80F, D85, EB12, EB12+12, EB8, EG140S, EM12, EM12+12, EM20, EM20+20, ES12, ES20, ESD12, ESD20, ETS15, FE12, FE20, FE20+20, FE30...(Other models you can see in the webshop)		

auxiliary contacts



1

Part No.	380821	Ref. No.	00000627 (old version) 00006270 (old version)
description	auxiliary contact contacts 1NO/1NC AC15 10A connection screw type LA1DN11		



relays





power relays

with DIN rail mounting

lateral



1

Part No.	380629	Ref. No.	25240004
description	power relays FINDER 24VAC 16A 3CO connection male faston 4.8mm DIN rail manuf. no. 60.33.8.024.0008		
For models:	D120, EN, ET, ET020, ETA, LP60, LP70, LPE100, LPE145		
accessories for	380629		
	Part No.	380703	Ref. No. —
	adapter for flange mounting suitable for Finder relay 62 series.		
	Part No.	380811	Ref. No. —
	adapter with bracket mounting suitable for Finder relay 62 series.		
	Part No.	380954	Ref. No. —
	adapter hole distance 54mm bracket mounting suitable for Finder relay 62 series. L 41mm W 39mm H 49mm		
	Part No.	381003	Ref. No. —
	adapter for DIN rail mounting suitable for Finder relay 62 series.		
	Part No.	381039	Ref. No. —
	adapter for DIN rail mounting suitable for Finder relay 62 series.		

with bracket mounting



1

Part No.	380626	Ref. No.	25130101 25130102
description	power relays FINDER 230VAC 10A 2CO connection male faston 4.8mm bracket mounting manuf. no. 62.62.8.230.0000		
For models:	C44, C66, C77, D120, D80, D80F, LP130, LP60, LP60H, LP61, LP61H, LP70		



1

Part No.	380139	Ref. No.	25130100
description	power relays FINDER 230VAC 16A 2CO connection F6.3 bracket mounting dimensions 68x38.2x35.8mm manuf. no. 62.82.8.230.0000		
For models:	42, 42E, 48, 48E, 55, 55E, 882, 885, B11, B15, BD46, BD50, BE35, BE40, BE50, BE50T, C34, C34dgt, C44dgt, C44dgt-elt, C66dgt, C66dgt-elt, CE24, D120dgt, D30, D36, D45, D85, LP70		

transformers

encapsulated transformers

PMA



1

Part No.	379054	Ref. No.	22192006
description	transformer primary 230VAC secondary 12VAC 3VA secondary 0.25A H 40mm L 45mm W 50mm connection screw 50/60Hz type 153/M		
For models:	ETS15, LP130, LP60, LP60H, LP61, LP61H, LP70		

electronic controllers

EVCO - EVERY CONTROL

universal controllers

built-in version



1

Part No.	378270	Ref. No.	22192001
description	electronic controller EVERY CONTROL mounting measurements 71x29mm built-in depth 59mm 12/24V voltage AC/DC PTC relay outputs 1 relay with probe protection IP65 -50 up to +150°C display 4 digits cable length 1430mm 16 type EVK411		



1

Part No.	378280	Ref. No.	22192002 22192005+22192006 22192009
description	electronic controller EVERY CONTROL mounting measurements 71x29mm built-in depth 59mm 12V voltage AC/DC PTC with probe protection IP65 -50 up to +150°C display 4 digits cable length 1430mm probe ø 6mm 16 type EVK411		
For models:	ETS15, LP130, LP60, LP60H, LP61, LP61H, LP70		

electronic thermometers

built-in version



1

Part No.	379900	Ref. No.	22191001 22192001
description	thermometer EVERY CONTROL type TM103T N4 mounting measurements 58x25.5mm 24V voltage AC -40 up to +110°C measuring input NTC display 2½ digit front measurements 31x64mm protection IP54 accuracy 1%		

SHANGFANG

accessories



1

Part No.	379054	Ref. No.	22192006
description	transformer primary 230VAC secondary 12VAC 3VA secondary 0.25A H 40mm L 45mm W 50mm connection screw 50/60Hz type 153/M		
For models:	ETS15, LP130, LP60, LP60H, LP61, LP61H, LP70		

probes

universal probes

temperature probes



1

Part No.	379142	Ref. No.	22192003
description	temperature probe PTC 1k0hm cable PVC probe -50 up to +150°C cable -10 up to 100°C probe ø6x30mm cable length 1.5m without screw connection 2-wire		
For models:	ETE20, ETE21, ETE25, ETE27, ETS15, LP130, LP60, LP60H, LP61, LP61H, LP70		

producer-specific probes

probes



1

Part No.	378361	Ref. No.	00590021
description	temperature probe GCPTP-51F cable PTFE probe°C cable -40 up to +250°C connection male faston 6.3mm thread probe 20mm cable length 24.5m		
For models:	BD47, C44dgt, C44dgt-elt, C66dgt, C66dgt-elt, Cybergel, D120dgt, D36, D45, D85		



1

Part No.	378343	Ref. No.	25192400
description	temperature probe NTC 10k0hm cable silicone probe -40 up to +110°C cable -50 up to +180°C connection 2-wire thread probe ø7x30mm cable length 1m		
For models:	BD47, C44, C44dgt, C44dgt-elt, C66, C66dgt, C66dgt-elt, C77, D40, D40ELT-BT-BA, D40i-ELT-BT-BA, D45, D85		

electronics

PCBs



1

Part No.	403775	Ref. No.	25192030
description	control PCB warewashing D35/36/45/46/47 L 170mm W 28mm connection coded plug suitable for ELFRAMO		
For models:	BD46, BD47, C34, C34dgt, C44dgt, C44dgt-elt, C66dgt, C66dgt-elt, D120dgt, D36, D45, D85		

1

Part No.	403919	Ref. No.	25192041
description	PCB		
For models:	BD46, BD47		



			
1			
Part No.	403163	Ref. No.	25192040
description	PCB dishwasher C34/C44/C66 230V 50/60A		
For models:	C34, C34dgt, C44dgt, C44dgt-elt, C66dgt, C66dgt-elt, D120dgt, D36, D45, D85		

			
1			
Part No.	402990	Ref. No.	25192020
description	PCB dishwasher D35/40		
For models:	D35, D40i, D40i-BT-BA		

keypads

control panel

			
1			
Part No.	109182	Ref. No.	00038675
description	control panel fryer GW ELT/GWD ELT W 223mm H 70mm D 20mm		
For models:	GSDT12, GSdT20, GST12, GST20, GVM35T, GW12ELT, GW209T, GW20ELT, GWD12ELT, GWD209T, GWD20ELT, GWDT12, GWDT20, GWT12, GWT20		

			
1			
Part No.	403262	Ref. No.	00222433
description	control panel warewashing BE35 W 178mm H 48mm D 58mm suitable for ELFRAMO		
For models:	BD50, BE35, BE40, BE50		

solenoid valves

solenoid valves (water)

ELBI			
			
1			
Part No.	370257	Ref. No.	23120003
description	solenoid valve triple straight 230VAC inlet 3/4" outlet 11.5mm t.max. 90°C ELBI plastic output B 2.5l/min flow regulating valve outlet B orange		
For models:	42, 42E, 48, 48E, 55, 55E, 60, B11, BD11, BD13, BD14, BD14alt, BD22, BD46, BD47, BD50, BE35, BE40, BE50, BE50T, D35, D36, D40, D40ELT, D40ELT-BT-BA, D40i, D40i-BT-BA, D40i-ELT-BT-BA, D45		

RPE			
			
1			
Part No.	374017	Ref. No.	23120021
description	solenoid valve single straight 230VAC inlet 3/4" outlet 10mm input 6l/min DN10 RPE polyamide flow regulating valve inlet white membranes NBR pressure range 0.2-10bar		







TP			
			
1			
Part No.	370021	Ref. No.	00003120 23120001
description	solenoid valve double straight 230VAC inlet 3/4" outlet 11.5mm DN10 TP flow regulating valve inlet white		
For models:	120, 160, 240, 42, 42E, 48, 48E, 55, 55E, 60, 882, 885, 904, 906, 908, 912, BD14, BD14alt, BD22, BD46, BD47, D40, D40ELT, SQ885, SQT80		
spare parts for	370021		
		Part No.	371013 Ref. No. —
accessories for	370021		
		Part No.	371220 Ref. No. —
		Part No.	371221 Ref. No. —
		Part No.	371222 Ref. No. —
		Part No.	371223 Ref. No. —
		Part No.	371224 Ref. No. —
		Part No.	371225 Ref. No. —
		Part No.	371226 Ref. No. —
		Part No.	371230 Ref. No. —
		Part No.	371231 Ref. No. —
		Part No.	371232 Ref. No. —

Table continues overleaf



accessories for		370021		
Part No.	Ref. No.	Ref. No.	Ref. No.	—
	371233	Ref. No.	Ref. No.	—
reducer TP flow rate 0.8l/min white tolerance ±25%				
	371234	Ref. No.	Ref. No.	—
reducer TP flow rate 1l/min light blue tolerance ±25%				
	371235	Ref. No.	Ref. No.	—
reducer TP flow rate 1.2l/min brown tolerance ±25%				
	371236	Ref. No.	Ref. No.	—
reducer TP flow rate 1.5l/min light brown tolerance ±25%				
	371237	Ref. No.	Ref. No.	—
reducer TP flow rate 2.5l/min yellow tolerance ±25%				
	371238	Ref. No.	Ref. No.	—
reducer TP flow rate 3.4l/min dark green tolerance ±25%				
	371239	Ref. No.	Ref. No.	—
reducer TP flow rate 5l/min black tolerance ±25%				
	371240	Ref. No.	Ref. No.	—
reducer TP flow rate 8l/min blue tolerance ±20%				



1	Part No.	370111	Ref. No.	00003090 23120002
	description	solenoid valve double straight 24VAC inlet 3/4" outlet 11.5mm DN10 TP		
	For models:	SQ885, SQT80		
	spare parts for	370111		
	Part No.	371035	Ref. No.	—
solenoid coil 24VAC				
	accessories for	370111		
	Part No.	371220	Ref. No.	—
reducer TP flow rate 3l/min red tolerance ±15%				
	Part No.	371221	Ref. No.	—
reducer TP flow rate 5.5l/min yellow tolerance ±15%				
	Part No.	371222	Ref. No.	—
reducer TP flow rate 6l/min grey tolerance ±15%				
	Part No.	371223	Ref. No.	—
reducer TP flow rate 10l/min white tolerance ±15%				
	Part No.	371224	Ref. No.	—
reducer TP flow rate 12l/min bronze tolerance ±15%				
	Part No.	371225	Ref. No.	—
reducer TP flow rate 16l/min light brown tolerance ±15%				

accessories for		370111		
Part No.	Ref. No.	Ref. No.	Ref. No.	—
	371226	Ref. No.	Ref. No.	—
reducer TP flow rate 20l/min red tolerance ±15%				
	371230	Ref. No.	Ref. No.	—
reducer TP flow rate 0.25l/min red tolerance ±25%				
	371231	Ref. No.	Ref. No.	—
reducer TP flow rate 0.35l/min violet tolerance ±25%				
	371232	Ref. No.	Ref. No.	—
reducer TP flow rate 0.5l/min orange tolerance ±25%				
	371233	Ref. No.	Ref. No.	—
reducer TP flow rate 0.8l/min white tolerance ±25%				
	371234	Ref. No.	Ref. No.	—
reducer TP flow rate 1l/min light blue tolerance ±25%				
	371235	Ref. No.	Ref. No.	—
reducer TP flow rate 1.2l/min brown tolerance ±25%				
	371236	Ref. No.	Ref. No.	—
reducer TP flow rate 1.5l/min light brown tolerance ±25%				
	371237	Ref. No.	Ref. No.	—
reducer TP flow rate 2.5l/min yellow tolerance ±25%				
	371238	Ref. No.	Ref. No.	—
reducer TP flow rate 3.4l/min dark green tolerance ±25%				
	371239	Ref. No.	Ref. No.	—
reducer TP flow rate 5l/min black tolerance ±25%				
	371240	Ref. No.	Ref. No.	—
reducer TP flow rate 8l/min blue tolerance ±20%				





1		Part No.	370017	Ref. No.	23120021
	description	solenoid valve single straight 230VAC inlet 3/4" outlet 11.5mm DN10 TP p max 10bar			
	spare parts for	370017			
	Part No.	371013	Ref. No.	Ref. No.	—
solenoid coil TP 230VAC 50/60Hz					
	accessories for	370017			
	Part No.	371220	Ref. No.	Ref. No.	—
reducer TP flow rate 3l/min red tolerance ±15%					
	Part No.	371221	Ref. No.	Ref. No.	—
reducer TP flow rate 5.5l/min yellow tolerance ±15%					



Table continues overleaf





accessories for		370017	
Part No.	371222	Ref. No.	—
	reducer TP flow rate 6l/min grey tolerance ±15%		
Part No.	371223	Ref. No.	—
	reducer TP flow rate 10l/min white tolerance ±15%		
Part No.	371224	Ref. No.	—
	reducer TP flow rate 12l/min bronze tolerance ±15%		
Part No.	371225	Ref. No.	—
	reducer TP flow rate 16l/min light brown tolerance ±15%		
Part No.	371226	Ref. No.	—
	reducer TP flow rate 20l/min red tolerance ±15%		
Part No.	371230	Ref. No.	—
	reducer TP flow rate 0.25l/min red tolerance ±25%		
Part No.	371231	Ref. No.	—
	reducer TP flow rate 0.35l/min violet tolerance ±25%		
Part No.	371232	Ref. No.	—
	reducer TP flow rate 0.5l/min orange tolerance ±25%		
Part No.	371233	Ref. No.	—
	reducer TP flow rate 0.8l/min white tolerance ±25%		
Part No.	371234	Ref. No.	—
	reducer TP flow rate 1l/min light blue tolerance ±25%		
Part No.	371235	Ref. No.	—
	reducer TP flow rate 1.2l/min brown tolerance ±25%		
Part No.	371236	Ref. No.	—
	reducer TP flow rate 1.5l/min light brown tolerance ±25%		
Part No.	371237	Ref. No.	—
	reducer TP flow rate 2.5l/min yellow tolerance ±25%		
Part No.	371238	Ref. No.	—
	reducer TP flow rate 3.4l/min dark green tolerance ±25%		
Part No.	371239	Ref. No.	—
	reducer TP flow rate 5l/min black tolerance ±25%		
Part No.	371240	Ref. No.	—
	reducer TP flow rate 8l/min blue tolerance ±20%		

metal			
SIRAI			
2-way			
L140-B series			
			
1			
Part No.	370239	Ref. No.	23140006
description	solenoid valve 2-ways 230VAC connection 1/2" L 41mm DN 10mm slide-on receptacle compact -10 up to +90°C SIRAI type series L140-B coil type Z610A membranes NBR (water) p max 12bar p min 0.35bar		
For models:	CW650-15, CW650-16, CW650-35, CW650-36, ETS15, LP130, LP70		
accessories for	370239		
	Part No.	371085	Ref. No.
	solenoid coil 230VAC 4VA SIRAI coil type ZB10A seat ø 10mm 50/60Hz		
	Part No.	371163	Ref. No.
	membrane connection 1/2" series L140-B membrane type NBR (water)		
accessories for	370239		
	Part No.	371091	Ref. No.
	power socket plug type DIN 43650B cable lengthmm small		

			
1			
Part No.	370472	Ref. No.	23140004
description	solenoid valve 2-ways 24VAC inlet 1/2" connection 1/2" L 41mm DN 10mm -10 up to +90°C SIRAI coil type Z610A membranes NBR (water) p max 12bar p min 0.35bar 24V voltage AC		
For models:	EN, ET, ET020, ETA, ETE20, ETE21, ETE25, ETE27, ETS15, LPE100, LPE145		

L180-B series			
			
1			
Part No.	370391	Ref. No.	00056800 23150002
description	solenoid valve 2-ways 24VAC connection 3/4" L 79mm DN 18mm -10 up to +90°C coil type Z610A membranes NBR (water) p max 12bar p min 0.35bar		
accessories for	370391		
	Part No.	371091	Ref. No.
	power socket plug type DIN 43650B cable lengthmm small		



			
1			
Part No.	370329	Ref. No.	00005692 23140003
description	solenoid valve 2-ways 24VAC inlet 1/2" outlet 1/2" connection 1/2" L 66mm DN 13.5mm slide-on receptacle compact -10 up to +90°C SIRAI type series L180-B coil type Z610A membranes NBR (water) p max 12bar p min 0.35bar		
For models:	ET, ETA		
spare parts for	370329		
	Part No.	371070	Ref. No. 00005661 23160001
	solenoid coil 24VAC 10VA SIRAI coil type Z610A seat ø 10mm		
	Part No.	371171	Ref. No. —
	membrane series L180-B membrane type NBR (water)		
accessories for	370329		
	Part No.	371091	Ref. No. —
	power socket plug type DIN 43650B cable lengthmm small		





			
1			
Part No.	370252	Ref. No.	00005680 23150002
description	solenoid valve 2-ways 24VAC inlet 3/4" outlet 3/4" L 79mm DN 18mm slide-on receptacle compact -10 up to +90°C SIRAI type series L180-B coil type Z610A membranes NBR (water) p max 12bar p min 0.35bar		
spare parts for	370252		
	Part No.	371070	Ref. No. 00005661 23160001
	solenoid coil 24VAC 10VA SIRAI coil type Z610A seat ø 10mm		
	Part No.	371172	Ref. No. —
	membrane connection 3/4" series L180-B membrane type NBR (water)		
accessories for	370252		
	Part No.	371091	Ref. No. —
	power socket plug type DIN 43650B cable lengthmm small		

			
1			
Part No.	370047	Ref. No.	23140006
description	solenoid valve brass 2-ways 230VAC inlet 1/2" outlet 1/2" connection 1/2" L 66mm DN 13.5mm slide-on receptacle compact -10 up to +90°C SIRAI type series L180-B coil type Z610A membranes NBR (water) p max 12bar p min 0.35bar 50/60Hz		
spare parts for	370047		
	Part No.	371085	Ref. No. —
	solenoid coil 230VAC 4VA SIRAI coil type ZB10A seat ø 10mm 50/60Hz		
	Part No.	371171	Ref. No. —
	membrane series L180-B membrane type NBR (water)		
accessories for	370047		
	Part No.	371091	Ref. No. —
	power socket plug type DIN 43650B cable lengthmm small		

solenoid valves steam (water)

2-way



L145-R series

			
1			
Part No.	370318	Ref. No.	00056600 23150001 23160001
description	solenoid valve 2-ways 24VAC inlet 1/2" outlet 1/2" connection 1/2" L 66mm DN 10mm slide-on receptacle compact -60 up to +170°C SIRAI type series L145-R coil type Z614A membranes PTFE (steam) p max 8bar p min 0.4bar		
spare parts for	370318		
	Part No.	371158	Ref. No. —
	solenoid coil 24VAC 10VA SIRAI coil type Z614A seat ø 10mm		
	Part No.	371164	Ref. No. —
	membrane connection 3/8"-1/2" series L145-R membrane type PTFE		
accessories for	370318		
	Part No.	371091	Ref. No. —
	power socket plug type DIN 43650B cable lengthmm small		



L153-D series



Part No.	370264	Ref. No.	23150003
description	solenoid valve 2-ways 230VAC inlet 1/2" outlet 1/2" connection 1/2" L 66mm DN 11.5mm slide-on receptacle DIN -10 up to 140°C SIRAI type series L153-D coil type Z134A membranes EPDM (steam/water) p max 8bar p min 0.1bar		
For models:	LP130		
spare parts for	370264		
	Part No.	371077	Ref. No. —
	solenoid coil 230VAC 24VA SIRAI coil type Z110A/Z114A/Z134A seat ø 14mm		
	Part No.	371167	Ref. No. —
	membrane connection 1/2" series L153-D membrane type EPDM		
accessories for	370264		
	Part No.	371090	Ref. No. —
	power socket plug type DIN 43650A screw		



Part No.	370327	Ref. No.	23150004
description	solenoid valve 2-ways 24VAC connection 1" L 105mm DN 22mm -10 up to 140°C SIRAI coil type Z923A membranes EPDM (steam/water) p max 8bar p min 0.1bar		



Part No.	370325	Ref. No.	00005660 23150001
description	solenoid valve 2-ways 24VAC inlet 3/4" outlet 3/4" connection 3/4" L 79mm DN 17mm slide-on receptacle DIN -10 up to 140°C SIRAI type series L153-D coil type Z134A membranes EPDM (steam/water) p max 8bar p min 0.1bar 50Hz		
For models:	EN, ET, ET020, ETA, ETE20, ETE21, ETE25, ETE27, LPE100, LPE145		

spare parts and accessories

solenoid coils



Part No.	371070	Ref. No.	00005661 23160001
description	solenoid coil 24VAC 10VA SIRAI coil type Z610A seat ø 10mm		
For models:	ET, ETA, LPE100, LPE145		
accessories for	371070		
	Part No.	371091	Ref. No. —
	power socket plug type DIN 43650B cable lengthmm small		

solenoid valves (various)



Part No.	370738	Ref. No.	00065310
description	solenoid valve 230VAC inlet 3/4" ET outlet 1" ET L 225mm with in-line particle filter SIRAI coil type Z610A 230V brass warewashing voltage AC		
For models:	LP130, LP70		

pressure switches

for warewashing

ø 58mm with male faston 6.3mm

with connection horizontal



Part No.	541314	Ref. No.	27100002
description	pressure control pressure range 46/26mbar connection 6mm ø 58mm pressure connection horizontal warewashing pressure connection ø 6mm		
For models:	B11, B15, BD11, BD13, BD14, BD22, BD46, BD47, BD50, BE35, BE40, BE50, BE50T, C33, D30, D35, D36, D40, D40ELT, D40i, D40i-BT-BA, D45, D80, D80F		



			
1			
Part No.	541006	Ref. No.	27100001
description	pressure control pressure range 60/20mbar connection 6mm ø 58mm pressure connection horizontal warewashing pressure connection ø 6mm		

			
1			
Part No.	541019	Ref. No.	00005960
description	pressure control pressure range 70/30mbar connection 6mm ø 58mm pressure connection horizontal warewashing pressure connection ø 6mm		

electrodes

			
1			
Part No.	403264	Ref. No.	00013897
description	level electrode total length 125mm angled ø 4mm		
For models:	BD47, C44, C44dgt, C44dgt-elt, C66, C66dgt, C66dgt-elt, C77, D40, D40ELT, D40ELT-BT-BA, D40i-BT-BA, D40i-ELT-BT-BA, D45, D85		

			
1			
Part No.	403263	Ref. No.	00014133
description	level electrode total length 75mm angled ø 4mm		
For models:	BD47, C44, C44dgt, C44dgt-elt, C66, C66dgt, C66dgt-elt, C77, D40, D40ELT, D40ELT-BT-BA, D40i-ELT-BT-BA, D45, D85		

pumps





wash and rinse pumps

FIR

pumps





1

Part No.	500927	Ref. No.	00002501
description	pump inlet ø 53mm outlet ø 44mm type 0213.1600 230V 50/60Hz 1 phase 1kW 1.36HP L 290mm rotation direction right capacitor 12.5µF FIR		
spare parts for	500927		
	Part No.	365014	Ref. No. 00002630
	operating capacitor capacity 12.5µF 450V tolerance 5%Hz ambient temperature max. -25 to +85°C ø 35mm L 70mm M8 plastic connection male faston 6.3mm 45S.C3DS.12.5 protection		
	Part No.	509010	Ref. No. 00002860
	impellor ø 105mm H 20mm M10L rotation direction right blades 4		
	Part No.	510693	Ref. No. 00003000 06150001
	mechanical shaft seal for shaft ø 12mm slide ring ext. ø 24mm slide ring H 15.5mm slide ring int. ø 11mm counter ring mounting ø 24mm height counter ring 8mm counter ring int. ø 13.5mm		
	Part No.	521543	Ref. No. 00002700
	pump cover ELFRAMO inlet ø 53mm outlet ø 44mm turn direction right ø 160mm ID ø 136mm inner height 34mm		
	Part No.	521717	Ref. No. 00000290 00002900 06140008 06140140
	O-ring EPDM thickness 1.78mm ID ø 120.37mm Qty 1 pcs		









1

Part No.	500098	Ref. No.	00002520 00002521 00002529 00071930 00071960
description	pump inlet \varnothing 62mm outlet \varnothing 49mm type B215.2500 230/400V 50/60Hz 3 phase 1.5kW 2HP L 332mm rotation direction right FIR		
For models:	120, 160, 906, 908, C44, C66, C66dgt, C66dgt-elt, C77, D120, D120dgt, ET, ETA, ETS15		
spare parts for	500098		
	Part No.	510693	Ref. No. 00000300 00003000 06150001
	mechanical shaft seal for shaft \varnothing 12mm slide ring ext. \varnothing 24mm slide ring H 15.5mm slide ring int. \varnothing 11mm counter ring mounting \varnothing 24mm height counter ring 8mm counter ring int. \varnothing 13.5mm		
	Part No.	511148	Ref. No. 00000287 00002870
	impellor \varnothing 118mm H 20mm M10L		
	Part No.	521544	Ref. No. 00002710
	pump cover inlet \varnothing 63mm outlet \varnothing 50mm turn direction right \varnothing 180mm ID \varnothing 165mm inner height 42mm		
	Part No.	521718	Ref. No. 00002910 06140010
	O-ring EPDM thickness 3.53mm ID \varnothing 164.7mm Qty 1 pcs		



1

Part No.	499051	Ref. No.	00002513
description	pump inlet \varnothing 62mm outlet \varnothing 50mm type B214 230V 50/60Hz 1 phase 1kW rotation direction right capacitor 12.5 μ F FIR		
For models:	120, 160, 906, 908, C44, C44dgt, C44dgt-elt, C66, C77, D120		
spare parts for	499051		
	Part No.	365014	Ref. No. 00002630
	operating capacitor capacity 12.5 μ F 450V tolerance 5%Hz ambient temperature max. -25 to +85°C \varnothing 35mm L 70mm M8 plastic connection male faston 6.3mm 45S.C3DS.12.5 protection		
	Part No.	509010	Ref. No. 00002860
	impellor \varnothing 105mm H 20mm M10L rotation direction right blades 4		
	Part No.	510693	Ref. No. 00000300 00003000 06150001
	mechanical shaft seal for shaft \varnothing 12mm slide ring ext. \varnothing 24mm slide ring H 15.5mm slide ring int. \varnothing 11mm counter ring mounting \varnothing 24mm height counter ring 8mm counter ring int. \varnothing 13.5mm		
	Part No.	517174	Ref. No. 03100008
	nut thread M8 H 6.5mm WS 13 SS DIN/ISO DIN 934 / ISO 4032/8673 Qty 1 pcs		
	Part No.	521544	Ref. No. 00002710
	pump cover inlet \varnothing 63mm outlet \varnothing 50mm turn direction right \varnothing 180mm ID \varnothing 165mm inner height 42mm		
	Part No.	521718	Ref. No. 00002910 06140010
	O-ring EPDM thickness 3.53mm ID \varnothing 164.7mm Qty 1 pcs		
	Part No.	560312	Ref. No. —
	plain washer ID \varnothing 10.5mm ED \varnothing 20mm thickness 2mm SS Qty 1 pcs DIN 125A for thread M10		



INSERT STAR

pumps







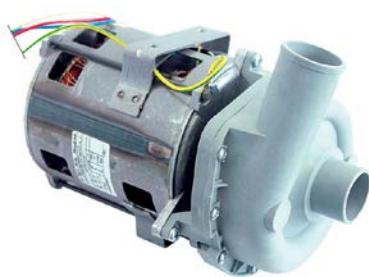

1

Part No.	499270	Ref. No.	20160040
description	pump inlet ø 38mm outlet ø 38mm type 2/102FA15 220/240V 50/60Hz 1 phase 0.26kW L 200mm rotation direction right INSERT-STAR		
For models:	BE40		
spare parts for	499270		
	Part No.	504578	Ref. No. —
	O-ring EPDM thickness 3.53mm ID ø 94.84mm Qty 1 pcs		
	Part No.	510693	Ref. No. 00000300 00003000 06150001
	mechanical shaft seal for shaft ø 12mm slide ringext. ø 24mm slide ring H 15.5mm slide ring int. ø 11mm counter ring mounting ø 24mm height counter ring 8mm counter ring int. ø 13.5mm		
	Part No.	650239	Ref. No. —
	impellor ø 75mm H 27mm pump type 2/102FA15 shaft intake ø 8mm rotation direction right thread M8L suitable for INSERTSTAR blades 6		
accessories for	499270		
	Part No.	365093	Ref. No. —
	operating capacitor capacity 6µF 400V tolerance 5% 50/60Hz ambient temperature max. -25 to +85°C ø 31.5mm L 55mm M8 plastic connection male faston 6.3mm protection		



1

Part No.	500320	Ref. No.	20160042
description	pump inlet ø 38mm outlet ø 38mm type 2/123/FA30 230V 50Hz 1 phase 0.59kW 0.8HP L 235mm rotation direction right capacitor 10µF INSERTSTAR		
For models:	BD50, BE50, BE50T		
spare parts for	500320		
	Part No.	510693	Ref. No. 00000300 00003000 06150001
	mechanical shaft seal for shaft ø 12mm slide ringext. ø 24mm slide ring H 15.5mm slide ring int. ø 11mm counter ring mounting ø 24mm height counter ring 8mm counter ring int. ø 13.5mm		
	Part No.	521000	Ref. No. —
	pump cover FAGOR inlet ø 38mm outlet ø 38mm		
	Part No.	521255	Ref. No. —
	impellor ø 88mm H 33mm M8L pump type 2/123/FA30 shaft ø 12mm		







spare parts for	500320		
	Part No.	532491	Ref. No. —
	O-ring EPDM thickness 3.53mm ID ø 120.2mm Qty 1 pcs		
accessories for	500320		
	Part No.	365015	Ref. No. 24100009
	operating capacitor capacity 10µF 400V tolerance 5%Hz ambient temperature max. -25 to +85°C ø 35.5mm L 59mm M8 plastic connection male faston 6.3mm protection		
	Part No.	551227	Ref. No. —
	female faston size 6.3x0.8mm 1.0-2.5mm ² straight CuZn gal Sn t.max. 110°C Qty 10 pcs		

LAFERT

pumps











1





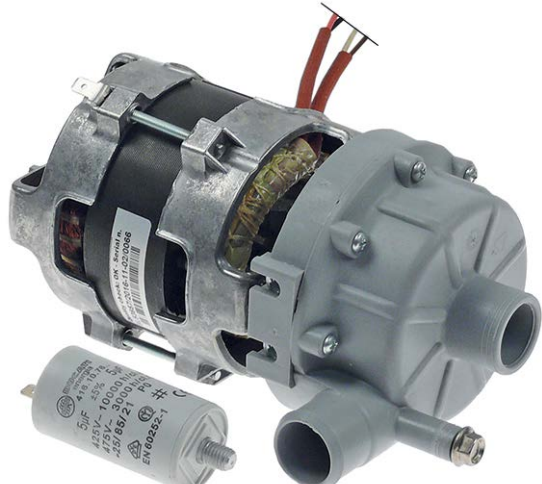

Part No.	500088	Ref. No.	00002510 00025190 00071800
description	pump inlet ø 62mm outlet ø 50mm type AMEE 71Z AA2 230/400V 50/60Hz 3 phase 0.75kW 1HP L 310mm rotation direction right Lafert		
For models:	C44, C44dgt, C44dgt-elt, C66, C77, D120, EN, ET, ET020, ETA, ETE20, ETE21, ETE25, ETE27		
spare parts for	500088		
	Part No.	509010	Ref. No. 00002860
	impellor ø 105mm H 20mm M10L rotation direction right blades 4		
	Part No.	510693	Ref. No. 00000300 00003000 06150001
	mechanical shaft seal for shaft ø 12mm slide ringext. ø 24mm slide ring H 15.5mm slide ring int. ø 11mm counter ring mounting ø 24mm height counter ring 8mm counter ring int. ø 13.5mm		
	Part No.	511132	Ref. No. 00002770
	pump cover bottom part		
	Part No.	517174	Ref. No. 03100008
	nut thread M8 H 6.5mm WS 13 SS DIN/ISO DIN 934 / ISO 4032/8673 Qty 1 pcs		
	Part No.	521544	Ref. No. 00002710
	pump cover inlet ø 63mm outlet ø 50mm turn direction right ø 180mm ID ø 165mm inner height 42mm		
	Part No.	521718	Ref. No. 00002910 06140010
	O-ring EPDM thickness 3.53mm ID ø 164.7mm Qty 1 pcs		
	Part No.	560312	Ref. No. —
	plain washer ID ø 10.5mm ED ø 20mm thickness 2mm SS Qty 1 pcs DIN 125A for thread M10		



			
1			
Part No.	500097	Ref. No.	00002523
description	pump inlet \varnothing 62mm outlet \varnothing 50mm type AMM80Z 230V 50Hz 1 phase 1.5kW 2HP L 320mm rotation direction right capacitor 25 μ F Lafert		
For models:	120, 160, 906, 908, C44, C66, C66dgt, C66dgt-elt, C77, D120, D120dgt		
spare parts for	500097		
	Part No.	511148	Ref. No. 0000287 00002870
	impellor \varnothing 118mm H 20mm M10L		
	Part No.	521544	Ref. No. 00002710
	pump cover inlet \varnothing 63mm outlet \varnothing 50mm turn direction right \varnothing 180mm ID \varnothing 165mm inner height 42mm		





LGB			
			
1			
Part No.	499204	Ref. No.	20160048
description	pump inlet \varnothing 28mm outlet \varnothing 26mm type ZF119SX 230V 50Hz 1 phase 0.15kW 0.2HP L 195mm rotation direction right capacitor 5 μ F auxiliary pressure connection 12mm LGB		
For models:	C34, C34dgt, C44, C44dgt, C44dgt-elt, C66, C66dgt, C66dgt-elt, C77, D120, D120dgt, D80, D85, LP61, LP61H		
spare parts for	499204		
	Part No.	365017	Ref. No. —
	operating capacitor capacity 5 μ F 450V tolerance 5% 50/60Hz ambient temperature max. -25 to +85°C \varnothing 28mm L 54mm M8 plastic connection male faston 6.3mm 16.10.08 protection		
	Part No.	510703	Ref. No. 06150006
	mechanical shaft seal for shaft \varnothing 13mm slide ring H 13mm height counter ring 5.5mm ED \varnothing 26mm		
	Part No.	521057	Ref. No. 20161002
	pump cover LGB inlet \varnothing 28mm outlet \varnothing 26mm auxiliary pressure connection 12mm supporting pressure open turn direction right \varnothing 102mm ID \varnothing 77mm inner height 31mm		
	Part No.	521114	Ref. No. —
	impellor \varnothing 48mm H 17mm pump type ZF119SX shaft \varnothing 13mm shaft length 12mm		
	Part No.	528800	Ref. No. —
	O-ring EPDM thickness 2.62mm ID \varnothing 75.87mm Qty 1 pcs		

			
1			
Part No.	501556	Ref. No.	20160027
description	pump inlet \varnothing 28mm outlet \varnothing 26mm type ZF119SX 230V 50Hz 1 phase 0.2kW 0.27HP L 186mm rotation direction right capacitor 5 μ F LGB		
For models:	BE35		
spare parts for	501556		
	Part No.	521057	Ref. No. 20161002
	pump cover LGB inlet \varnothing 28mm outlet \varnothing 26mm auxiliary pressure connection 12mm supporting pressure open turn direction right \varnothing 102mm ID \varnothing 77mm inner height 31mm		

			
1			
Part No.	500094	Ref. No.	20160025
description	pump inlet \varnothing 28mm outlet \varnothing 26mm type ZF131SX 230V 50Hz 1 phase 0.2kW 0.15HP L 195mm rotation direction left capacitor 6.3 μ F LGB		
For models:	42, 42E, 48, 48E, 55, 55E, B11, BD11		
spare parts for	500094		
	Part No.	365012	Ref. No. 24100001
	operating capacitor capacity 6.3 μ F 450V tolerance 5% 50Hz ambient temperature max. -25 to +85°C \varnothing 30mm L 61mm M8 plastic connection male faston 6.3mm protection		
	Part No.	502266	Ref. No. 20161000
	pump cover inlet \varnothing 28mm outlet \varnothing 26mm		
	Part No.	510703	Ref. No. 06150006
	mechanical shaft seal for shaft \varnothing 13mm slide ring H 13mm height counter ring 5.5mm ED \varnothing 26mm		
	Part No.	521085	Ref. No. —
	impellor \varnothing 72mm H 17mm thread M7L shaft \varnothing 13mm shaft length 12mm blades 3		
	Part No.	528800	Ref. No. —
	O-ring EPDM thickness 2.62mm ID \varnothing 75.87mm Qty 1 pcs		



1

Part No.	500539	Ref. No.	00202481
description	pump inlet ø 28mm outlet ø 26mm type ZF170SX 230V 50Hz 1 phase 0.32kW 0.44HP L 200mm rotation direction right capacitor 8µF LGB		
For models:	B15, BD13, BD14, BD14alt, BD46, BD47		
spare parts for	500539		
	Part No.	509004	Ref. No. 00210036
	impellor ø 71mm H 16mm M7L rotation direction right shaft ø 13mm shaft length 13mm blades 8		
	Part No.	510703	Ref. No. 06150006
	mechanical shaft seal for shaft ø 13mm slide ring H 13mm height counter ring 5.5mm ED ø 26mm		
	Part No.	521057	Ref. No. 20161002
	pump cover LGB inlet ø 28mm outlet ø 26mm auxiliary pressure connection 12mm supporting pressure open turn direction right ø 102mm ID ø 77mm inner height 31mm		
	Part No.	528800	Ref. No. —
	O-ring EPDM thickness 2.62mm ID ø 75.87mm Qty 1 pcs		
accessories for	500539		
	Part No.	365013	Ref. No. —
	operating capacitor capacity 8µF 400V tolerance 5%Hz ambient temperature max. -25 to +85°C ø 31.5mm L 55mm M8 plastic connection male faston 6.3mm protection		







1

Part No.	500092	Ref. No.	00202480
description	pump inlet ø 50mm outlet ø 44mm type W300SX 230V 50Hz 1 phase 0.3kW 0.5HP L 170mm rotation direction right capacitor 10µF LGB		
For models:	42, 42E, 48, 48E, 55, 55E, 60, BD22		
spare parts for	500092		
	Part No.	365015	Ref. No. 24100009
	operating capacitor capacity 10µF 400V tolerance 5%Hz ambient temperature max. -25 to +85°C ø 35.5mm L 59mm M8 plastic connection male faston 6.3mm protection		

spare parts for	500092		
	Part No.	510554	Ref. No. —
	O-ring EPDM thickness 2mm ID ø 120mm Qty 1 pcs		
	Part No.	510607	Ref. No. 00210029 00210032
	impellor ø 85mm H 29mm shaft intake ø 9x8mm rotation direction right blades 6		
	Part No.	510693	Ref. No. 00000300 00003000 06150001
	mechanical shaft seal for shaft ø 12mm slide ring ext. ø 24mm slide ring H 15.5mm slide ring int. ø 11mm counter ring mounting ø 24mm height counter ring 8mm counter ring int. ø 13.5mm		
	Part No.	511178	Ref. No. 00202460
	pump cover bottom part		
	Part No.	521564	Ref. No. 00210028
	pump cover		



1

Part No.	500093	Ref. No.	00202485 00202486 20160062
description	pump inlet ø 50mm outlet ø 44mm type W500SX 230V 50Hz 1 phase 0.5kW 0.7HP L 200mm rotation direction right capacitor 16µF LGB		
For models:	42, 42E, 48, 48E, 55, 55E, 60, D30, D35, D36, D40, D40ELT, D40ELT-BTBA, D40i, D40i-BT-BA, D40i-ELT-BT-BA, D45		
spare parts for	500093		
	Part No.	365021	Ref. No. 24100004
	operating capacitor capacity 16µF 425V tolerance 5% 50/60Hz ambient temperature max. -25 to +85°C ø 35mm L 73mm single M8 plastic connection male faston 6.3mm 416.10.99 protection		
	Part No.	510607	Ref. No. 00210029 00210032
	impellor ø 85mm H 29mm shaft intake ø 9x8mm rotation direction right blades 6		
	Part No.	510693	Ref. No. 00000300 00003000 06150001
	mechanical shaft seal for shaft ø 12mm slide ring ext. ø 24mm slide ring H 15.5mm slide ring int. ø 11mm counter ring mounting ø 24mm height counter ring 8mm counter ring int. ø 13.5mm		
	Part No.	521564	Ref. No. 00210028
	pump cover		
	Part No.	521717	Ref. No. 00000290 00002900 06140008 06140140
	O-ring EPDM thickness 1.78mm ID ø 120.37mm Qty 1 pcs		





Part No.	499225	Ref. No.	00002591 20160053
description	pump inlet \varnothing 50mm outlet \varnothing 50mm type ZF400VSX 230V 50Hz 1 phase 0.81kW 1.1HP L 245mm rotation direction right capacitor 16 μ F C 34 dgt / C 44 dgt LGB		
For models:	C34, C44dgt, CE24		
spare parts for	499225		
	Part No.	365021	Ref. No. 24100004
	operating capacitor capacity 16 μ F 425V tolerance 5% 50/60Hz ambient temperature max. -25 to +85°C \varnothing 35mm L 73mm single M8 plastic connection male faston 6.3mm 416.10.99 protection		
	Part No.	510703	Ref. No. 06150006
	mechanical shaft seal for shaft \varnothing 13mm slide ring H 13mm height counter ring 5.5mm ED \varnothing 26mm		
	Part No.	520454	Ref. No. 00004072 0000407B 05100008
	hose clamp \varnothing 70-90mm width 9mm Qty 5 pcs DIN 3017		
	Part No.	521090	Ref. No. —
	impellor \varnothing 101mm H 32mm thread M8L shaft \varnothing 13mm shaft length 12mm		
	Part No.	521548	Ref. No. —
	pump cover LGB inlet \varnothing 50mm outlet \varnothing 50mm		
	Part No.	532623	Ref. No. —
	O-ring EPDM thickness 2.62mm ID \varnothing 120.32mm Qty 1 pcs		

OLYMPIA

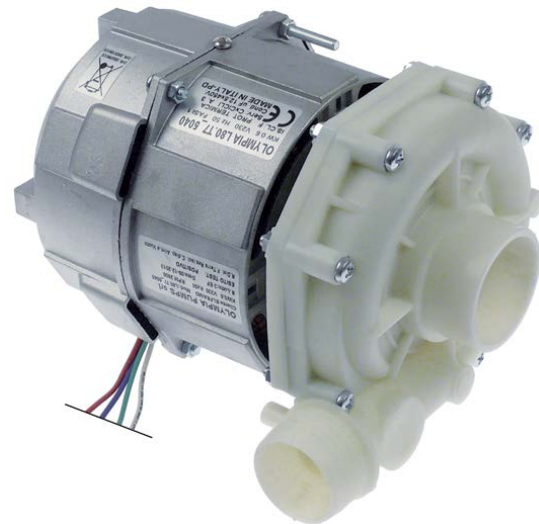
pumps







Part No.	499217	Ref. No.	20160063
description	pump inlet \varnothing 50mm outlet \varnothing 40mm type L80.T7_5040 230V 50Hz 1 phase 0.6kW 0.8HP L 205mm rotation direction right capacitor 12.5 μ F D 85 dgt OLYMPIA		
spare parts for	499217		
	Part No.	365014	Ref. No. 00002630
	operating capacitor capacity 12.5 μ F 450V tolerance 5%Hz ambient temperature max. -25 to +85°C \varnothing 35mm L 70mm M8 plastic connection male faston 6.3mm 45S.C3DS.12.5 protection		
	Part No.	510554	Ref. No. —
	O-ring EPDM thickness 2mm ID \varnothing 120mm Qty 1 pcs		
	Part No.	510693	Ref. No. 00000300 00003000 06150001
	mechanical shaft seal for shaft \varnothing 12mm slide ring ext. \varnothing 24mm slide ring H 15.5mm slide ring int. \varnothing 11mm counter ring mounting \varnothing 24mm height counter ring 8mm counter ring int. \varnothing 13.5mm		
	Part No.	512415	Ref. No. 20161004
	pump cover OLYMPIA inlet \varnothing 50mm outlet \varnothing 40mm		
	Part No.	517368	Ref. No. —
	impellor \varnothing 102mm H 21mm rotation direction right thread M10L suitable for Dihr blades 8		



1			
Part No.	499314	Ref. No.	20160062
description	pump inlet \varnothing 50mm outlet \varnothing 41mm type L71T5_5040 230V 50Hz 1 phase 0.38kW L 200mm rotation direction right capacitor 10 μ F OLYMPIA		
spare parts for	499314		
	Part No.	365015	Ref. No. 24100009
	operating capacitor capacity 10 μ F 400V tolerance 5%Hz ambient temperature max. -25 to +85°C \varnothing 35.5mm L 59mm M8 plastic connection male faston 6.3mm protection		
	Part No.	510554	Ref. No. —
	O-ring EPDM thickness 2mm ID \varnothing 120mm Qty 1 pcs		
	Part No.	510693	Ref. No. 00003000 00003000 06150001
	mechanical shaft seal for shaft \varnothing 12mm slide ringext. \varnothing 24mm slide ring H 15.5mm slide ring int. \varnothing 11mm counter ring mounting \varnothing 24mm height counter ring 8mm counter ring int. \varnothing 13.5mm		
	Part No.	512415	Ref. No. 20161004
	pump cover OLYMPIA inlet \varnothing 50mm outlet \varnothing 40mm		
	Part No.	521157	Ref. No. 20161501
	impellor \varnothing 82mm H 22mm thread M10L		



1			
Part No.	499338	Ref. No.	20160072
description	pump inlet \varnothing 62mm outlet \varnothing 50mm type MEC71.T120SX 220-240/380-415V 50Hz 3 phase 0.88kW 1.2HP L 310mm rotation direction right OLYMPIA		
spare parts for	499338		
	Part No.	510693	Ref. No. 00003000 00003000 06150001
	mechanical shaft seal for shaft \varnothing 12mm slide ringext. \varnothing 24mm slide ring H 15.5mm slide ring int. \varnothing 11mm counter ring mounting \varnothing 24mm height counter ring 8mm counter ring int. \varnothing 13.5mm		
	Part No.	521152	Ref. No. 20161100
	pump cover OLYMPIA inlet 62 \varnothing 190mm		
	Part No.	521153	Ref. No. 20161003
	pump casing OLYMPIA outlet \varnothing 52mm		
	Part No.	521154	Ref. No. 06140046
	O-ring ID \varnothing 152.7mm thickness 2.62mm EPDM Qty 1 pcs		







1			
Part No.	542117	Ref. No.	20160066
description	pump inlet \varnothing 62mm outlet \varnothing 52mm type L80.T200SX 230V 50Hz 1 phase 1.5kW L 340mm rotation direction right capacitor 17/17 μ F OLYMPIA		
spare parts for	542117		
	Part No.	521152	Ref. No. 20161100
	pump cover OLYMPIA inlet 62 \varnothing 190mm		
	Part No.	521153	Ref. No. 20161003
	pump casing OLYMPIA outlet \varnothing 52mm		







Table continues overleaf



spare parts for 542117			
	Part No.	521154	Ref. No. 06140046
O-ring ID ø 152.7mm thickness 2.62mm EPDM Qty 1 pcs			
	Part No.	521155	Ref. No. 20161500 20161506
impellor ø 107mm H 34mm pump type OLYMPIA thread M8L blades 6			
accessories for 542117			
	Part No.	542157	Ref. No. 00018280
bracket for wash pump L 267mm W 132mm H 43mm			



1

Part No.	499226	Ref. No.	20160061
description	pump inlet ø 62mm outlet ø 52mm type MEC80.T200SX 230/400V 50Hz 3 phase 1.5kW 2HP L 340mm rotation direction right OLYMPIA		
For models:	C66dgt		
spare parts for 499226			
	Part No.	510693	Ref. No. 00000300 00003000 06150001
mechanical shaft seal for shaft ø 12mm slide ring ext. ø 24mm slide ring H 15.5mm slide ring int. ø 11mm counter ring mounting ø 24mm height counter ring 8mm counter ring int. ø 13.5mm			
	Part No.	521152	Ref. No. 20161100
pump cover OLYMPIA inlet 62 ø 190mm			
	Part No.	521153	Ref. No. 20161003
pump casing OLYMPIA outlet ø 52mm			
	Part No.	521154	Ref. No. 06140046
O-ring ID ø 152.7mm thickness 2.62mm EPDM Qty 1 pcs			
	Part No.	521155	Ref. No. 20161500 20161506
impellor ø 107mm H 34mm pump type OLYMPIA thread M8L blades 6			
accessories for 499226			
	Part No.	542157	Ref. No. 00018280
bracket for wash pump L 267mm W 132mm H 43mm			

booster pumps I



1

Part No.	500540	Ref. No.	20160001 20160054
description	pump inlet ø 1" IT outlet ø 1" IT type PKM60 230V 50Hz 1 phase 0.37kW PEDRELLO 0.5HP		
For models:	120, 160, 240, 882, 885, 904, 906, 908, 912, C33, C34, C34dgt, C44, C44dgt, C44dgt-elt, C66, C66dgt, C66dgt-elt, C77, D120, D120dgt, D80, D80F, D85, LP130, LP60, LP60H, LP61, LP61H, LP70, SQ885, SQT80		
accessories for 500540			
	Part No.	365015	Ref. No. 24100009
operating capacitor capacity 10µF 400V tolerance 5%Hz ambient temperature max. -25 to +85°C ø 35.5mm L 59mm M8 plastic connection male faston 6.3mm protection			



1

Part No.	499067	Ref. No.	20160003
description	pump inlet ø 1" IT outlet ø 1" IT type PKM60 230V 60Hz 1 phase 0.37kW 0.5HP L 247mm rotation direction left capacitor 10µF PEDRELLO		
For models:	120, 160, 240, 882, 885, 904, 906, 908, 912, C33, C34, C34dgt, C44, C44dgt, C44dgt-elt, C66, C66dgt, C66dgt-elt, C77, D120, D120dgt, D80, D85, LP130, LP60, LP60H, LP61, LP61H, LP70, SQ885, SQT80		





1

Part No.	499308	Ref. No.	20160056
description	pump inlet ø 1" IT outlet ø 1" IT type PQM60 220V 60Hz 1 phase 0.37kW 0.5HP L 195mm rotation direction left capacitor 10µF PEDRELLO		
For models:	C34, C44dgt, C66dgt		



			
1			
Part No.	499145	Ref. No.	00047030 20160004 20160055
description	pump inlet \varnothing 1" outlet \varnothing 1" type PQ60 230/400V 50Hz 3 phase 0.37kW PEDRELLIO		
For models:	EN, ET, ETA, ETE20, ETE21, ETE25, ETE27, ETS15, LPE100, LPE145		

			
1			
Part No.	500395	Ref. No.	20160011 20160016
description	pump inlet \varnothing 3/8" IT outlet \varnothing 3/8" IT type PS45DX 230V 50Hz 0.35kW capacitor 8 μ F LGB		
For models:	B11, BD11, BD13, BD14, BD14alt, BD22, BD46, BD47, BD50, BE50, D30, D35, D36, D40, D40ELT, D40ELT-BT-BA, D40i, D40i-ELT-BT-BA, D45, D80, LP60, LP60H		
spare parts for	500395		
	Part No.	365013	Ref. No. —
	operating capacitor capacity 8 μ F 400V tolerance 5%Hz ambient temperature max. -25 to +85°C \varnothing 31.5mm L 55mm M8 plastic connection male faston 6.3mm protection		
	Part No.	698400	Ref. No. —
	pump cover gasket pump type PS46 thickness 2mm ID \varnothing 66mm Qty 1 pcs		

drain pumps

HANNING

			
1			
Part No.	500082	Ref. No.	00002570
description	drain pump 230V 100W		
For models:	882, 885, C33, C44, C66, C77, D30, D40, D80, D80F		

PLASET

			
1			
Part No.	500083	Ref. No.	20160014
description	drain pump inlet \varnothing 30mm outlet \varnothing 23mm 220-240V 34W 50Hz PLASET		
For models:	42, 42E, 48, 48E, 55, 55E, 60, B11, BD11, BD13, BD14, BD14alt, BD22, BD46, BD47, BD50, BE35, BE40, BE50, BE50T, D30, D35, D36, D40, D40ELT, D40ELT-BT-BA, D40i, D40i-ELT-BT-BA, D45		

miscellaneous

			
1			
Part No.	499001	Ref. No.	20160013
description	drain pump inlet \varnothing 30mm outlet \varnothing 22mm 220V 34W 60Hz PLASET		
For models:	BD13, BD14, BD50, BE35, BE40, BE50, BE50T, D35, D36, D40, D40i, D40i-ELT-BT-BA, D45		

booster pumps II

accessories

			
1			
Part No.	365015	Ref. No.	24100009
description	operating capacitor capacity 10 μ F 400V tolerance 5%Hz ambient temperature max. -25 to +85°C \varnothing 35.5mm L 59mm M8 plastic connection male faston 6.3mm protection		

			
1			
Part No.	365012	Ref. No.	24100001
description	operating capacitor capacity 6.3 μ F 450V tolerance 5% 50Hz ambient temperature max. -25 to +85°C \varnothing 30mm L 61mm M8 plastic connection male faston 6.3mm protection		

condensators & interference
suppression filters

operating capacitors

plastic



1

Part No.	365015	Ref. No.	24100009
description	operating capacitor capacity 10 μ F 400V tolerance 5%Hz ambient temperature max. -25 to +85°C \varnothing 35.5mm L 59mm M8 plastic connection male faston 6.3mm protection		



1

Part No.	365014	Ref. No.	00002630
description	operating capacitor capacity 12.5 μ F 450V tolerance 5%Hz ambient temperature max. -25 to +85°C \varnothing 35mm L 70mm M8 plastic connection male faston 6.3mm 45S.C3DS.12.5 protection		
For models:	120, 160, 882, 885, C44, C66		



1

Part No.	365021	Ref. No.	24100004
description	operating capacitor capacity 16 μ F 425V tolerance 5% 50/60Hz ambient temperature max. -25 to +85°C \varnothing 35mm L 73mm single M8 plastic connection male faston 6.3mm 416.10.99 protection		
For models:	42, 42E, 48, 48E, 55, 55E, 60, BD22, C33, C34, C34dgt, C44, C44dgt, C44dgt-elt, C66, C77, CW650-15, CW650-16, CW650-35, CW650-36, D30, D35, D36, D40, D40ELT, D40ELT-BT-BA, D40i, D40i-BT-BA, D40i-ELT-BT-BA, D45, D80, D80F, D85		



1

Part No.	365012	Ref. No.	24100001
description	operating capacitor capacity 6.3 μ F 450V tolerance 5% 50Hz ambient temperature max. -25 to +85°C \varnothing 30mm L 61mm M8 plastic connection male faston 6.3mm protection		

filters

interference suppression filters

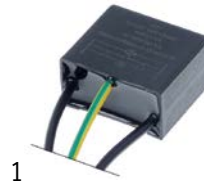

1

Part No.	365026	Ref. No.	00002650 24100100
description	interference suppression filter capacity 0.47 μ F(X2)+2x0.01 μ F(Y2) 0.68M Ω hm		



1

Part No.	365044	Ref. No.	00002650 24100100
description	interference suppression filter type FC701Y2F 250V 50-60Hz conductor 2 with E connection cable 200mm L 42mm \varnothing 23mm Hmm Wmm plastic Qty 1 pcs		



1

Part No.	365089	Ref. No.	24100102
description	interference suppression filter type X1+100R 250V capacity 0.24 μ F		
For models:	120, 885, 906, 908, C33, C34, C34dgt, C44, C44dgt, C44dgt-elt, C66, C66dgt, C66dgt-elt, C77, D35, D36, D40, D40i, D40i-ELT-BT-BA, D45, D80, D85, EM20, EM20+20, ES20, ESD20		

fuses

fine fuses



1

Part No.	358041	Ref. No.	00060970
description	fine fuse size \varnothing 10x38mm 20A slow-acting rated 400V type aM Qty 1 pcs		
For models:	EN, ET, ET020, ETA, LPE100, LPE145		



1

Part No.	358030	Ref. No.	00060980
description	fine fuse size \varnothing 10x38mm 32A slow-acting rated 400V type aM Qty 1 pcs		
For models:	EN, ET, ET020, ETA, LPE100, LPE145		



1 

Part No.	358038	Ref. No.	00060960 37130999
description	fine fuse size \varnothing 10x38mm 10A slow-acting rated 500V type aM Qty 1 pcs		
For models:	120, 160, 240, 882, 885, 904, 906, 908, 912, CW650-15, CW650-16, CW650-35, CW650-36, Cybergel, EB12, EB12+12, EG140S, EM240, EM360, EM480, EM612, EM-HT, EN, ES12, ESD12, ET, ET020, ETA, ETE20, ETE21, ETE25, ETE27, ETS15, LPE100, LPE145, SQ885, SQT80		

2 

Part No.	358040	Ref. No.	00006261
description	fine fuse size \varnothing 10x38mm 16A slow-acting rated 500V type aM Qty 1 pcs		

fine fuse holders

1 

Part No.	358075	Ref. No.	00006121 37170001
description	fuse holder for fuse \varnothing 10x38mm suitable fuse \varnothing 10x38mm 1-pole 32A rated 690V for DIN rail 35mm cross section 10mm ² suitable for fuse \varnothing 10x38mm		
For models:	120, 160, 240, 882, 885, 904, 906, 908, 912, Cybergel, EM240, EM360, EM480, EM612, EM-HT, EN, ET, ET020, ETA, ETE20, ETE21, ETE25, ETE27, ETS15, LPE100, LPE145, SQ885, SQT80		

electric accessories

cables

ribbon cables

group 1

1 

Part No.	403776	Ref. No.	25190105
description	ribbon cable 10-pole L 2600mm plug type FC-10P raster size 2.54mm		
For models:	BD46, BD47, C34, C34dgt, C44dgt, C44dgt-elt, C66dgt, C66dgt-elt, D120dgt, D36, D45, D85		

terminals

rail-mounted terminals

miscellaneous

1 



Part No.	358505	Ref. No.	00006260
description	rail-mounted terminal 6-10mm ² 1-pole		

gas thermostats















SIT





710 Minisit series

1 

Part No.	107543	Ref. No.	00034620
description	gas thermostat kit SIT type MINISIT 710 t.max. 190°C 110-190°C gas inlet 1/2" IT gas outlet 3/8" IT thermocouple connection M9x1 probe \varnothing 6mm probe L 105mm capillary pipe 1050mm pressure controller no		
For models:	FG125, FG157, FG159, FG307, FG309, GM12, GM12+12, GM20+20, GM20+20-900, GM25+25-900, GM25-900, GM35, GM50-900, GW-MODULARI		
spare parts for	107543		
	Part No.	101135	Ref. No. 00038639 16100006
	gas thermostat SIT type MINISIT 710 t.max. 190°C 110-190°C gas inlet 1/2" gas outlet 3/8" thermocouple connection M9x1 pilot connection M10x1 probe \varnothing 6mm probe L 102mm capillary pipe 1050mm probe type type A3 pressure controller no pressure regulatormbar gland nut		
	Part No.	390730	Ref. No. 161142 22170003
	safety thermostat switch-off temp. 230°C 1-pole 0.5A probe \varnothing 4mm probe L 125mm capillary pipe 1550mm capillary pipe isolated 1410mm gland nut probe		



			
Part No.	101135	Ref. No.	00038639 16100006
description	gas thermostat SIT type MINISIT 710 t.max. 190°C 110-190°C gas inlet 1/2" gas outlet 3/8" thermocouple connection M9x1 pilot connection M10x1 probe ø 6mm probe L 102mm capillary pipe 1050mm probe type type A3 pressure controller no pressure regulatormbar gland nut		
For models:	GVM35, GW12, GW20, GWD12, GWD20		
spare parts for	101135		
	Part No.	101053	Ref. No. —
	magnet unit T1: M9x1 T2: M24x1 L 45mm ø 17mm suitable for Minisit		
	Part No.	102118	Ref. No. —
	probe 110-190°C probe ø 6mm probe L 102mm capillary pipe 1050mm t.max. 190°C fryer probe type type A3 suitable for MINISIT 710		
accessories for	101135		
	Part No.	100809	Ref. No. —
	O-ring EPDM thickness 2mm ID ø 21mm Qty 1 pcs		
	Part No.	100820	Ref. No. —
	gland duct ET M14x1.5 IT M10x0.75 probe ø max. 6.5mm WS 22		
	Part No.	100904	Ref. No. —
	locking screw M10x1 for pipe ø 4mm Qty 1 pcs		
	Part No.	100905	Ref. No. —
	locking screw M10x1 for pipe ø 6mm Qty 1 pcs		
	Part No.	101054	Ref. No. —
	magnet unit T1: M10x1 T2: M24x1 L 45mm ø 17mm suitable for Minisit		
	Part No.	101136	Ref. No. 00032410
	piezoelectric igniter suitable for Minisit with cover cap ømm connection F6.3x0.8		
	Part No.	101137	Ref. No. —
	cover cap without piezoelectric igniter		
	Part No.	101267	Ref. No. —
	reducer IT 3/8" ET 1/2" L 21mm		
	Part No.	101268	Ref. No. —
	gas connection thread 3/8" angled with O-ring MINISIT 710		
	Part No.	101269	Ref. No. —
	gas connection thread 1/2" angled with O-ring MINISIT 710		
	Part No.	101270	Ref. No. —
	screw connection IT 3/8" ET 3/8" L 28mm		
	Part No.	101272	Ref. No. —
	screw connection IT 1/2" ET 3/8" L 57mm		

accessories for	101135		
	Part No.	101273	Ref. No. —
	olive for pipe ø 12mm L 9.5mm brass Qty 1 pcs suitable for universal		
	Part No.	101274	Ref. No. —
	olive for pipe ø 16mm Qty 1 pcs		
	Part No.	101275	Ref. No. —
	union screw thread 1/2" for pipe ø 16mm Qty 1 pcs		
	Part No.	101276	Ref. No. —
	union screw thread 3/8" tube ø 12mm Qty 1 pcs		
	Part No.	110068	Ref. No. 16100003
	knob suitable for Minisit ø 37mm		









			
Part No.	101434	Ref. No.	00032390
description	gas thermostat without accessories SIT type MINISIT 710 t.max. 190°C 110-190°C gas inlet 1/2" gas outlet 3/8" thermocouple connection M9x1 pilot connection M10x1 probe ø 5mm probe L 102mm capillary pipe 1200mm probe type type G1 pressure controller no pressure regulatormbar gland nut		
For models:	FG125, FG157, FG159, FG307, FG309, GM12, GM12+12, GM20+20, GM20+20-900, GM25+25-900, GM2532, GM2542, GM25-900, GM35, GM50-900, GMD2532, GMD2542, GW12, GW20, GWD12, GWD20, GW-MODULARI		
spare parts for	101434		
	Part No.	101053	Ref. No. —
	magnet unit T1: M9x1 T2: M24x1 L 45mm ø 17mm suitable for Minisit		
	Part No.	102105	Ref. No. 16100030
	probe 110-200°C probe ø 6mm probe L 102mm capillary pipe 1050mm t.max. 200°C fryer probe type type G1 suitable for MINISIT 710		
accessories for	101434		
	Part No.	100809	Ref. No. —
	O-ring EPDM thickness 2mm ID ø 21mm Qty 1 pcs		
	Part No.	100904	Ref. No. —
	locking screw M10x1 for pipe ø 4mm Qty 1 pcs		
	Part No.	100905	Ref. No. —
	locking screw M10x1 for pipe ø 6mm Qty 1 pcs		
	Part No.	101054	Ref. No. —
	magnet unit T1: M10x1 T2: M24x1 L 45mm ø 17mm suitable for Minisit		
	Part No.	101136	Ref. No. 00032410
	piezoelectric igniter suitable for Minisit with cover cap ømm connection F6.3x0.8		

Table continues overleaf



accessories for		101434	
	Part No.	101137	Ref. No. —
	cover cap without piezoelectric igniter		
	Part No.	101267	Ref. No. —
	reducer IT 3/8" ET 1/2" L 21mm		
	Part No.	101268	Ref. No. —
	gas connection thread 3/8" angled with O-ring MINISIT 710		
	Part No.	101269	Ref. No. —
	gas connection thread 1/2" angled with O-ring MINISIT 710		
	Part No.	101270	Ref. No. —
	screw connection IT 3/8" ET 3/8" L 28mm		
	Part No.	101272	Ref. No. —
	screw connection IT 1/2" ET 3/8" L 57mm		
	Part No.	101273	Ref. No. —
	olive for pipe ø 12mm L 9.5mm brass Qty 1 pcs suitable for universal		
	Part No.	101274	Ref. No. —
	olive for pipe ø 16mm Qty 1 pcs		
	Part No.	101275	Ref. No. —
	union screw thread 1/2" for pipe ø 16mm Qty 1 pcs		
	Part No.	101276	Ref. No. —
	union screw thread 3/8" tube ø 12mm Qty 1 pcs		
	Part No.	110068	Ref. No. 16100003
	knob suitable for Minisit ø 37mm		

accessories

probes



1

Part No.	102105	Ref. No.	16100030
description	probe 110-200°C probe ø 6mm probe L 102mm capillary pipe 1050mm t.max. 200°C fryer probe type type G1 suitable for MINISIT 710		
For models:	GM12, GM12+12, GM20+20, GM20+20-900, GM25+25-900, GM25-900, GM35, GM50-900		

gas valves and ignition boxes

gas control valves

SIT

NOVASIT



1

Part No.	101187	Ref. No.	16100005
description	gas valve SIT series Novasit 820 0.17VHz gas inlet 1/2" gas outlet 1/2" thermocouple connection M9x1 pilot connection M10x1 ignition pressurebar pressure range 5-50mbar pressure regulator connection blind equiv. no. 0.820.301 supply Operator millivolt		
For models:	GSDT12, GSDT20, GST12, GST20, GVM35T, GW209T, GWD209T, GWDT12, GWDT20, GWT12, GWT20		
spare parts for	101187		
	Part No.	101065	Ref. No. —
	magnet unit with cable L 44mm D1 ø 30mm D2 ø 20mm suitable for NOVASIT		
accessories for	101187		
	Part No.	100110	Ref. No. —
	pilot burner SIT type 190 series 3 flames nozzle ømm gas connectionmm		
	Part No.	101305	Ref. No. —
	gas connection straight 1/2" flange 45x45mm ELETTROSIT/V4400/4600/4605 suitable for SIT/HONEYWELL hole distance 36x36mm		
	Part No.	101306	Ref. No. —
	gas connection angled flange 45x45mm hole distance 36x36mm 1/2" ELETTROSIT/V4400/4600/4605 screw with O-ring suitable for SIT/HONEYWELL		
	Part No.	101307	Ref. No. —
	gas connection straight flange 45x45mm hole distance 36x36mm 3/4" ELETTROSIT/V4400/4600/4605 screw with O-ring suitable for SIT/HONEYWELL		
	Part No.	101308	Ref. No. —
	gas connection angled flange 45x45mm hole distance 36x36mm 3/4" ELETTROSIT/V4400/4600/4605 screw with O-ring suitable for SIT/HONEYWELL		
	Part No.	102116	Ref. No. 17100002
	thermopile ROBERTSHAW L 900mm probe ø 9mm probe L 57mm 250-750mV screw connection 7/16"		



Part No.	101956	Ref. No.	16100020
description	gas valve SIT series Novasit 820 230V 50Hz gas inlet 1/2" gas outlet 1/2" thermocouple connection M9x1 pilot connection M10x1 ignition pressurembar pressure range 5-50mbar pressure regulator connection blind equiv. no. 0.820.031		
spare parts for	101956		
	Part No.	101065	Ref. No. —
	magnet unit with cable L 44mm D1 ø 30mm D2 ø 20mm suitable for NOVASIT		
	Part No.	101313	Ref. No. —
	solenoid coil 230V 50Hz		
accessories for	101956		
	Part No.	100006	Ref. No. —
	piezoelectric igniter suitable for ELETTROSIT body plastic blowing connection ø2.4mm ø 14mm		
	Part No.	101305	Ref. No. —
	gas connection straight 1/2" flange 45x45mm ELETTROSIT/V4400/4600/4605 suitable for SIT/HONEYWELL hole distance 36x36mm		
	Part No.	101306	Ref. No. —
	gas connection angled flange 45x45mm hole distance 36x36mm 1/2" ELETTROSIT/V4400/4600/4605 screw with O-ring suitable for SIT/HONEYWELL		
	Part No.	101307	Ref. No. —
	gas connection straight flange 45x45mm hole distance 36x36mm 3/4" ELETTROSIT/V4400/4600/4605 screw with O-ring suitable for SIT/HONEYWELL		
	Part No.	101308	Ref. No. —
	gas connection angled flange 45x45mm hole distance 36x36mm 3/4" ELETTROSIT/V4400/4600/4605 screw with O-ring suitable for SIT/HONEYWELL		
	Part No.	101312	Ref. No. —
	microswitch		
	Part No.	101314	Ref. No. —
	solenoid coil 24V 50Hz		
	Part No.	101317	Ref. No. —
	plug with cable L 1000mm suitable for NOVASIT		
	Part No.	101318	Ref. No. —
	cover cap for solenoid coil suitable for NOVASIT		

ignition parts

pilot burners

SIT

100 series

















Part No.	106906	Ref. No.	33120005
description	pilot burner SIT type 100 series 3 flames nozzle ø 0.2mm gas connection 6mm		
For models:	FG125, FG157, FG159, FG307, FG309, GM2532, GM2542, GMD2532, GMD2542, GW12, GW20, GWD12, GWD20		
spare parts for	106906		
	Part No.	100245	Ref. No. —
	pilot burner nozzle LPG code 20 bore ø 0.2mm Qty 1 pcs thread M8x0.75		
	Part No.	100855	Ref. No. —
	pilot burner bracket triple		
	Part No.	100885	Ref. No. —
	air mixing sleeve for pilot burner Qty 1 pcs		
	Part No.	100916	Ref. No. —
	compression spring for pilot burner Qty 1 pcs		
	Part No.	100917	Ref. No. —
	gasket for pilot burner Qty 1 pcs aluminium		
	Part No.	100918	Ref. No. —
	screw for pilot burner		
	Part No.	107162	Ref. No. —
	pilot burner cap SIT 3 flames Hmm Lmm Qty 1 pcs		
	Part No.	107701	Ref. No. —
	pilot burner bottom part SIT 100 series nozzle ø 0.2mm		
accessories for	106906		
	Part No.	100245	Ref. No. —
	pilot burner nozzle LPG code 20 bore ø 0.2mm Qty 1 pcs thread M8x0.75		
	Part No.	100246	Ref. No. —
	pilot burner nozzle natural gas bore ø 0.35mm Qty 1 pcs thread M8x0.75		
	Part No.	100904	Ref. No. —
	locking screw M10x1 for pipe ø 4mm Qty 1 pcs		
	Part No.	100905	Ref. No. —
	locking screw M10x1 for pipe ø 6mm Qty 1 pcs		
	Part No.	102110	Ref. No. —
	pilot tube copper pipe ø 4mm thickness 1mm L 3000mm		

Table continues overleaf



accessories for		106906	
Part No.	102111	Ref. No.	—
	pilot tube copper pipe ø 6mm thickness 1mm L 3000mm		
Part No.	107171	Ref. No.	—
	pilot burner nozzle SIT natural/liquid gas bore ø 0.25mm Qty 1 pcs		
Part No.	107700	Ref. No.	—
	pilot burner bottom part SIT 100 series nozzle ø 0.25mm		
Part No.	107702	Ref. No.	—
	pilot burner bottom part SIT 100 series nozzle ø 0.35mm		

accessories



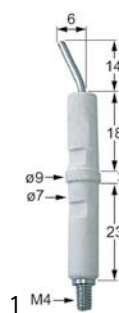

ignition electrodes



Part No.	100706	Ref. No.	33110002
description	ignition electrode connection M4 Qty 1 pcs		
For models:	FG125, FG12M, FG157, FG159, FG24M, FG307, FG309, GB10, GBD10, GM2532, GM2542, GMD2532, GMD2542, GW12, GW12ELT, GW20, GW20ELT, GWD12, GWD12ELT, GWD20, GWD20ELT, GW-MODULARI		

160 series



Part No.	100049	Ref. No.	00032790
description	pilot burner SIT type 160 series 2 flames nozzle ømm gas connectionmm		
For models:	GM12, GM12+12, GM20+20, GM20+20-900, GM25+25-900, GM25-900, GM35, GM50-900, GVM35		
spare parts for	100049		
	Part No.	100907	Ref. No. 33120009
	screw connection thread M10x1 Qty 1 pcs type SEF 1 ømm for thermocouple		
accessories for	100049		
	Part No.	100202	Ref. No. —
	pilot burner nozzle natural gas code 41 Qty 1 pcs nozzle ø 0.41mm		
	Part No.	100203	Ref. No. —
	pilot burner nozzle LPG code 25 Qty 1 pcs nozzle ø 0.25mm		
	Part No.	100701	Ref. No. 33110001
	ignition electrode connection M4 Qty 1 pcs		
	Part No.	100869	Ref. No. —
	pilot burner nozzle natural gas code 51 Qty 1 pcs suitable for 160 series nozzle ø 0.51mm		

accessories for		100049	
Part No.	100906	Ref. No.	33120004
	screw connection thread M10x1 for ignition electrode brass Qty 1 pcs WS 10		
	Part No.	100908	Ref. No. —
	union screw thread M10x1 for pipe ø 4mm Qty 1 pcs		
	Part No.	100909	Ref. No. —
	union screw thread M10x1 for pipe ø 6mm Qty 1 pcs		
	Part No.	101282	Ref. No. —
	olive for pipe ø 4mm L 7.4mm Qty 1 pcs		
	Part No.	101287	Ref. No. —
	olive for pipe ø 6mm Qty 1 pcs		
	Part No.	102110	Ref. No. —
	pilot tube copper pipe ø 4mm thickness 1mm L 3000mm		
	Part No.	102111	Ref. No. —
	pilot tube copper pipe ø 6mm thickness 1mm L 3000mm		
	Part No.	107650	Ref. No. 00032680
	pilot burner nozzle SIT LPG code 30 Qty 1 pcs		

190 series



Part No.	106722	Ref. No.	00038491
description	pilot burner SIT type 190 series 3 flames natural/liquid gas nozzle 35/51 nozzle ø 0.35/0.51mm gas connection 6mm complete with nozzle		
For models:	GSDT12, GSDT20, GST12, GST20, GVM35T, GW209T, GWD209T, GWDT12, GWDT20, GWT12, GWT20		

POLIDORO

pilot burners







Part No.	104485	Ref. No.	33120030
description	pilot burner POLIDORO 2 flames natural gas code 29.2 gas connection 6mm		
For models:	FG12M, FG24M, GB10, GBD10		





miscellaneous

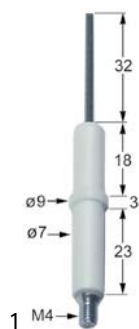

Part No.	106966	Ref. No.	00038531
description	pilot burner 2 flames natural/liquid gas nozzle \varnothing 0.45mm gas connection 6mm		
For models:	GW12, GW12ELT, GW20, GW20ELT, GWD12, GWD12ELT, GWD20, GWD20ELT, GW-MODULARI		
spare parts for	106966		
	Part No.	100855	Ref. No. —
	pilot burner bracket triple		
	Part No.	100885	Ref. No. —
	air mixing sleeve for pilot burner Qty 1 pcs		
	Part No.	102742	Ref. No. —
	pilot burner nozzle LPG code 25 bore \varnothing 0.25mm Qty 1 pcs		
	Part No.	102973	Ref. No. 18100093
	pilot burner nozzle natural gas bore \varnothing 0.45mm Qty 1 pcs		

electrodes



Part No.	100701	Ref. No.	33110001
description	ignition electrode connection M4 Qty 1 pcs		
For models:	GM12, GM12+12, GM20+20, GM20+20-900, GM25+25-900, GM25-900, GM35, GM50-900, GVM35		
accessories for	100701		
	Part No.	100906	Ref. No. 33120004
	screw connection thread M10x1 for ignition electrode brass Qty 1 pcs WS 10		

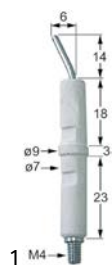

Part No.	100706	Ref. No.	33110002
description	ignition electrode connection M4 Qty 1 pcs		
For models:	FG125, FG12M, FG157, FG159, FG24M, FG307, FG309, GB10, GBD10, GM2532, GM2542, GMD2532, GMD2542, GW12, GW12ELT, GW20, GW20ELT, GWD12, GWD12ELT, GWD20, GWD20ELT, GW-MODULARI		

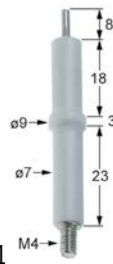

Part No.	102871	Ref. No.	33110003
description	ignition electrode D1 \varnothing 7mm D2 \varnothing 9mm connection M4 L1 8mm BL1 18mm BL2 3mm BL3 23mm to clip		
For models:	FG12M, FG24M, GB10, GBD10, GSDT12, GSDT20, GST12, GST20, GVM35T, GW209T, GWD209T, GWDT12, GWDT20, GWT12, GWT20		



Part No.	100906	Ref. No.	33120004
description	screw connection thread M10x1 for ignition electrode brass Qty 1 pcs WS 10		
For models:	GSDT12, GSDT20, GST12, GST20, GVM35, GVM35T, GW209T, GWD209T, GWDT12, GWDT20, GWT12, GWT20		

ignition cables

pre-assembled cables



Part No.	100015	Ref. No.	30140002
description	ignition cable cable length 600mm connection \varnothing 2.4mm / \varnothing 2.4mm		
For models:	FG12M, FG24M, GB10, GBD10, GM2532, GM2542, GMD2532, GMD2542, GW12, GW20, GWD12, GWD20		



Part No.	100025	Ref. No.	30140001
description	ignition cable cable length 600mm connection \varnothing 4mm / F6.3mm		
For models:	GVM35T, GW12ELT, GW209T, GW20ELT, GWD12ELT, GWD209T, GWD20ELT, GWDT12, GWDT20, GWT12, GWT20		

piezoelectric igniters

mounting diameter 22mm



Part No.	100005	Ref. No.	33100003
description	piezoelectric igniter body plastic blowing mounting \varnothing 22mm connection \varnothing 2.4mm cable lengthmm SIT		
For models:	FG12M, FG24M, GB10, GBD10, GM2532, GM2542, GMD2532, GMD2542, GW12, GW20, GW209T, GWD12, GWD20, GWD209T, GWDT12, GWDT20, GWT12, GWT20		



miscellaneous



1

Part No.	nla ¹	Ref. No.	00032460 00038700 33100001
description	piezoelectric igniter suitable for Minisit connection F6.3x0.8 ømm		
For models:	FG125, FG157, FG159, FG307, FG309, GM12, GM12+12, GM20+20, GM20+20-900, GM25+25-900, GM25-900, GM35, GM50-900, GSdT12, GSdT20, GST12, GST20, GVM35, GVM35T, GW12, GW12ELT, GW20, GW209T, GW20ELT, GWD12, GWD12ELT, GWD20, GWD209T, GWD20ELT, GWDT12, GWDT20, GW-MODULARI, GWT12, GWT20		

¹no longer available



1

Part No.	nla ¹	Ref. No.	00032410
description	piezoelectric igniter suitable for Minisit with cover cap ømm connection F6.3x0.8		
For models:	GM12, GM12+12, GM20+20, GM20+20-900, GM25+25-900, GM25-900, GM35, GM50-900		
spare parts for	101136		

	Part No.	100001	Ref. No.	00032460 00038700 33100001
	piezoelectric igniter suitable for Minisit connection F6.3x0.8 ømm			

¹no longer available

thermocouples

plug-in thermocouples

plug-in thermocouples with interruption

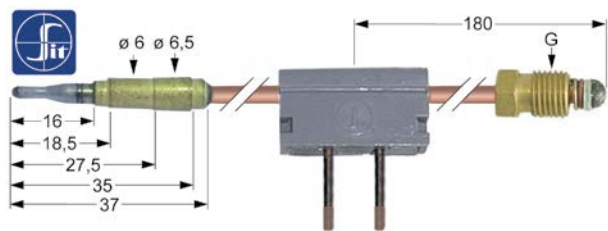

1

Part No.	107234	Ref. No.	159023 17100003
description	thermocouple SIT with interrupter M9x1 L 400mm plug connection ø6.0mm soldering connection		
For models:	GSdT12, GSdT20, GST12, GST20, GVM35T, GWDT12, GWDT20, GWT12, GWT20		

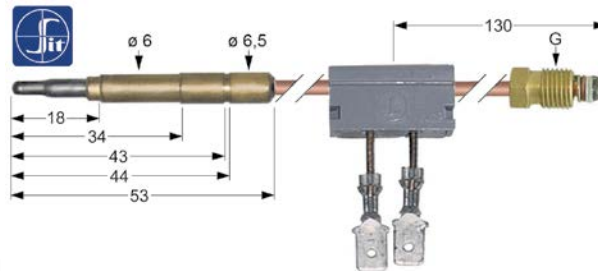

1

Part No.	107177	Ref. No.	00032580 17100001
description	thermocouple SIT with interrupter M9x1 L 600mm plug connection ø6.0mm F 6.3mm		
For models:	FG125, FG12M, FG157, FG159, FG24M, FG307, FG309, GB10, GBD10, GM12, GM12+12, GM20+20, GM20+20-900, GM25+25-900, GM2532, GM2542, GM25-900, GM35, GM50-900, GMD2532, GMD2542, GVM35, GW12, GW12ELT, GW20, GW209T, GW20ELT, GWD12, GWD12ELT, GWD20, GWD209T, GWD20ELT, GW-MODULARI		

thermopiles

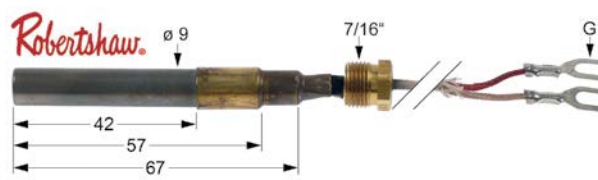

1

Part No.	102116	Ref. No.	17100002
description	thermopile ROBERTSHAW L 900mm probe ø 9mm probe L 57mm 250-750mV screw connection 7/16"		
For models:	GSdT12, GSdT20, GST12, GST20, GVM35T, GW209T, GWD209T, GWDT12, GWDT20, GWT12, GWT20		

gas burners

bar burners

bar burners



1

Part No.	105384	Ref. No.	15100004
description	bar burner 2 row L 450mm W 240mm ømm H 310mm fryer		
For models:	FG157, FG159, FG307, FG309, GM2542, GMD2542		



1

Part No.	104483	Ref. No.	15100010
description	bar burner ø 40mm Wmm Hmm L 340mm flange width 50mm flange length 62mm fryer		
For models:	FG12M, FG24M, GB10, GBD10		





			
1			
Part No.	105430	Ref. No.	15100008
description	bar burner ø 40mm Wmm Hmm L 340mm flange width 60mm flange length 76mm fryer		

gas nozzles

main nozzles

gas nozzles M10x1

			
1			
Part No.	100067	Ref. No.	18110093 18110121
description	gas injector thread M10x1 WS 12 bore ø 1.1mm G30 gas pressure 30mbar		
For models:	FG12M, FG24M, GB10, GBD10, GSDT12, GSDT20, GST12, GST20, GW12, GW12ELT, GW209T, GW20ELT, GWD12, GWD12ELT, GWD209T, GWD20ELT, GWD12, GWD20, GW-MODULARI, GWT12, GWT20		

			
1			
Part No.	107343	Ref. No.	18110111 18110130
description	gas injector thread M10x1 WS 12 bore ø 1.2mm LPG gas pressure 30mbar		
For models:	FG12M, FG24M, GB10, GBD10, GSDT12, GSDT20, GST12, GST20, GW209T, GWD209T, GWD12, GWD20, GW-MODULARI, GWT12, GWT20		

			
1			
Part No.	106290	Ref. No.	18110090 18110095 18110110
description	gas injector thread M10x1 WS 12 bore ø 1.85mm inner peaked		
For models:	FG157, FG159, FG307, FG309, GM2532, GM2542, GMD2532, GMD2542, GW20, GWD12, GWD20, GW-MODULARI, GWT12, GWT20		

pilot burner nozzles

pilot burner nozzles POLIDORO

			
1			
Part No.	100000	Ref. No.	18100060
description	pilot burner nozzle POLIDORO LPG code 22 bore ø 0.22mm Qty 1 pcs		
For models:	FG12M, FG24M, GB10, GBD10		

			
1			
Part No.	104486	Ref. No.	18100061
description	pilot burner nozzle POLIDORO natural gas code 29.2 bore ø 2x0.29mm Qty 1 pcs		
For models:	FG12M, FG24M, GB10, GBD10		

pilot burner nozzles SIT

100 series

			
1			
Part No.	102973	Ref. No.	18100093
description	pilot burner nozzle natural gas bore ø 0.45mm Qty 1 pcs		
For models:	GW12, GW12ELT, GW20, GW20ELT, GWD12, GWD20		

160 series

			
1			
Part No.	107172	Ref. No.	18100094
description	pilot burner nozzle SIT LPG code 25 Qty 1 pcs		
For models:	GW12, GW12ELT, GW20, GW20ELT, GWD12, GWD20		

			
1			
Part No.	107650	Ref. No.	00032680
description	pilot burner nozzle SIT LPG code 30 Qty 1 pcs		
For models:	GM12, GM12+12, GM20+20, GM20+20-900, GM25+25-900, GM25-900, GM35, GM50-900		

			
1			
Part No.	107173	Ref. No.	18100095
description	pilot burner nozzle SIT natural gas code 35 Qty 1 pcs suitable for 160 series nozzle ø 0.35mm		
For models:	GSDT12, GSDT20, GST12, GST20, GVM35, GVM35T, GW209T, GWD209T, GWD12, GWD20, GWT12, GWT20		





 <p>1</p>			
Part No.	107175	Ref. No.	00032690
description	pilot burner nozzle SIT natural gas code 51 Qty 1 pcs suitable for 160 series		
For models:	GM12, GM12+12, GM20+20, GM20+20-900, GM25+25-900, GM25-900, GM35, GM50-900, GSDT12, GSDT20, GST12, GST20, GVM35, GVM35T, GW209T, GWD209T, GWDT12, GWDT20, GWT12, GWT20		

auxiliary gas parts

screw connections

<p>union screws</p>  <p>1</p>			
Part No.	100906	Ref. No.	33120004
description	screw connection thread M10x1 for ignition electrode brass Qty 1 pcs WS 10		
For models:	GSDT12, GSDT20, GST12, GST20, GVM35, GVM35T, GW209T, GWD209T, GWDT12, GWDT20, GWT12, GWT20		

 <p>1</p>			
Part No.	100907	Ref. No.	33120009
description	screw connection thread M10x1 Qty 1 pcs type SEF 1 ømm for thermocouple		
For models:	GSDT12, GSDT20, GST12, GST20, GVM35T, GW209T, GWD209T, GWDT12, GWDT20, GWT12, GWT20		

<p>angle pieces</p>  <p>1</p>			
Part No.	104484	Ref. No.	12355007
description	angle piece T1: 1/2" ET T2: 1/2" ET		
For models:	GSDT12, GSDT20, GST12, GST20, GVM35T, GW12ELT, GW209T, GW20ELT, GWD12ELT, GWD209T, GWD20ELT, GWDT12, GWDT20, GWT12, GWT20		

equipment-specific units

for deep fryers

lids

 <p>1</p>			
Part No.	695603	Ref. No.	00030660
description	lid suitable for fryer L 305mm W 210mm with handle		
For models:	EB12+12, EB6, EB6+6		

 <p>1</p>			
Part No.	695606	Ref. No.	00030690
description	lid suitable for fryer L 340mm W 270mm		
For models:	EB12, EB12+12, EB8, EM12, EM12+12, ES12, ESD12, FE12, FG125, FG12M, FG24M, GB10, GBD10, GM12+12, GM2532, GMD2532, GST12, GW12, GW12ELT, GWD12, GWD12ELT, GWDT12, GWT12		

basket holders

 <p>1</p>			
Part No.	970736	Ref. No.	00038567
description	basket support for fryer W 265mm H 220mm suitable for ELFRAMO GW		
For models:	FG12M, FG24M, GB10, GBD10, GSDT12, GSDT20, GST12, GST20, GVM35, GVM35T, GW12ELT, GW209T, GW20ELT, GWD12, GWD20, GWD209T, GWDT12, GWDT20, GWT12, GWT20		



miscellaneous



1

Part No.	550268	Ref. No.	00032290
description	cover cap for push-button		
For models:	EB12, EB12+12, EB18P, EB6, EB6+6, EB8, EM12, EM12+12, EM20, EM20+20, EM20+20-900, EM20-900, EM35, EM40-900, ES12, ES20, ESD12, ESD20, FE12, FE20, FE20+20, FE30, FE30+30, KES20, KESD20		

for dishwashers

drain and intake components

ELFRAMO

drain /intake bodies



1

Part No.	517804	Ref. No.	00014169 00018351
description	connection angle thread 1/2" hose ø 13mm		
For models:	BD50, BE35, BE40, BE50, BE50T, C34, C44, C44dgt, C66, C66dgt, C77, D120, D35, D36, D40i, D40i-BT-BA, D40i-ELT-BT-BA, D45, D85		



1

Part No.	511843	Ref. No.	00012701
description	drain connection		
For models:	BD14, BD14alt, BD47, C33, C34, C34dgt, C44, C44dgt, C44dgt-elt, C66, C66dgt, C66dgt-elt, C77, CE24, CW650-15, CW650-16, CW650-35, CW650-36, D120, D120dgt, D30, D40, D80, D80F, D85, ETE20, ETE21, ETE25, ETE27, LP60, LP60H, LP61, LP61H		



1

Part No.	511830	Ref. No.	00211035
description	drain connection thread 1 3/4" hose ø 28.5mm		
For models:	B11, B15, BD11, BD13, BD14, BD22, BD47, BD50, BE35, BE40, BE50, BE50T, C44, C66, C77, D30, D35, D36, D40, D40ELT, D40ELT-BT-BA, D40i, D40i-BT-BA, D40i-ELT-BT-BA, D45		



1

Part No.	511838 ¹	Ref. No.	00211026
description	drain connection thread 1 3/4" hose ø 28mm		
For models:	B11, BD11, BD13, BD14, BD46, BD50, BE35, BE40, BE50, C34, C34dgt, C44dgt, C44dgt-elt, C66dgt, C66dgt-elt, D85, LP61, LP61H		

¹for drain pump

1

Part No.	511853	Ref. No.	00012702
description	drain fitting		
For models:	BD22, C33, C44, C66, CW650-15, CW650-16, CW650-35, CW650-36, D120, D120dgt, D30, D35, D36, D40, D40ELT, D40ELT-BT-BA, D40i, D40i-BT-BA, D40i-ELT-BT-BA, D45, D80, D80F, D85, ETE20, ETE21, ETE25, ETE27		



1

Part No.	511070	Ref. No.	00002130
description	drain fitting complete		
For models:	ET, ET020, ETA, ETE20, ETE21, ETE25, ETE27		



1

Part No.	511836	Ref. No.	00012715
description	drain fitting complete thread 1 3/4" ED ø 65mm ID ø 43mm hose ø 37mm		
For models:	C44, C66, D30, D80, LP60		



1

Part No.	512409	Ref. No.	00012703+00211035+06140018 00012741
-----------------	--------	-----------------	--

description	drain fitting complete thread 1 3/4" ED ø 70.5mm ID ø 52mm hose ø 28.5mm		
--------------------	--	--	--

spare parts for	512409		
------------------------	--------	--	--

Part No.	511826	Ref. No.	00012703
-----------------	--------	-----------------	----------



mounting ring thread 1 3/4" ID ø 44mm

Part No.	511828	Ref. No.	06140018
-----------------	--------	-----------------	----------



O-ring EPDM thickness 3.53mm ID ø 56.74mm Qty 1 pcs

Part No.	511830	Ref. No.	00211035
-----------------	--------	-----------------	----------



drain connection thread 1 3/4" hose ø 28.5mm



1			
Part No.	511835	Ref. No.	00211036
description	drain unit complete		
For models:	B11, B15		

1			
Part No.	511827	Ref. No.	00012704
description	flange ED ø 115mm ID ø 55mm		
For models:	B11, B15, BD11, BD13, BD14, BD46, BD47, BE35, BE40		

1			
Part No.	511085	Ref. No.	00002103
description	gasket suitable for ELFRAMO equiv. no. 00002103 outflow		
For models:	120, 160, 240, 882, 885, 906, 908, C44, C66, SQ885, SQT80		

1			
Part No.	511851	Ref. No.	00012728
description	intake body complete		
For models:	D80		

1			
Part No.	511846 ¹	Ref. No.	00018303
description	intake body complete thread 1 3/4"		
For models:	C44, C66, D120, ETE20, ETE21, ETE25, ETE27, LP60, LP60H, LP61, LP61H		

¹for drain pump

1			
Part No.	511092	Ref. No.	00002110
description	intake body ED ø 125mm H 100mm ID ø 62mm hose ø 70mm		

1			
Part No.	511079	Ref. No.	00202120
description	intake/drain body		
For models:	42, 42E, 48, 48E, 55, 55E, 60		

1			
Part No.	511094	Ref. No.	00002100 00011120
description	intake/drain body		
For models:	882, 885, SQ885, SQT80		

1			
Part No.	511096	Ref. No.	00011130
description	intake/drain body		
For models:	120, 160, 240, 906, 908, C44, C66		
accessories for	511096		
	Part No.	511463	Ref. No. 00003600
	hose connector thread 1 1/4" ø 28mm		

1			
Part No.	511837	Ref. No.	00012712
description	mounting ring thread 1 3/4" ED ø 65mm		
For models:	B11, BD11, BD13, BD14, BD46		

1			
Part No.	511826	Ref. No.	00012703
description	mounting ring thread 1 3/4" ID ø 44mm		
For models:	B11, B15, BD11, BD13, BD14, BD14alt, BD22, BD46, BD47, BD50, BE35, BE40, BE50, BE50T, C35, C34, C34dgt, C44, C44dgt, C44dgt-elt, C66, C66dgt, C66dgt-elt, C77, CE24, CW650-15, CW650-16, CW650-35, CW650-36, D120, D120dgt, D30, D35, D36, D40, D40ELT, D40ELT-BTBA, D40i, D40i-BT-BA, D40i-ELT-BT-BA, D45, D80, D80F, D85, ETE20, ETE21, ETE25, ETE27, LP60, LP60H...(Other models you can see in the webshop)		



1

Part No.	511828	Ref. No.	06140018
description	O-ring EPDM thickness 3.53mm ID ø 56.74mm Qty 1 pcs		
For models:	B11, B15, BD11, BD13, BD14, BD14alt, BD22, BD46, BD47, BD50, BE35, BE40, BE50, BE50T, C33, C34, C34dgt, C44, C44dgt, C44dgt-elt, C66, C66dgt, C66dgt-elt, C77, CE24, CW650-15, CW650-16, CW650-35, CW650-36, D120, D120dgt, D30, D35, D36, D40, D40ELT, D40ELT-BTBA, D40i, D40i-BT-BA, D40i-ELT-BT-BA, D45, D80, D80F, D85, ETE20, ETE21, ETE25, ETE27, ETS15, LP60...(Other models you can see in the webshop)		

filters



1

Part No.	507384	Ref. No.	00071600 00085810
description	filter		
For models:	EN, ET, ET020, ETA, LP130, LP70, LPE100, LPE145		



1

Part No.	511120	Ref. No.	00011020
description	flat filter		
For models:	120, 160, 904, 906, 908, 912		



1

Part No.	511121	Ref. No.	00011230
description	flat filter		
For models:	120, 160, 240, 904, 906, 908, 912, D120, D36, D45, D80, D80F, D85		



1

Part No.	511122	Ref. No.	00010930
description	flat filter		
For models:	120, 160		



1

Part No.	511852	Ref. No.	00010580
description	flat filter		
For models:	882, 885, 904, 906, 908, 912		



1

Part No.	511590	Ref. No.	00065523 00067144
description	flat filter H 15mm stainless steel L 318mm W 242mm		
For models:	D120, D120dgt, LP60, LP60H, LP61, LP61H, LP70		



1

Part No.	517491	Ref. No.	00065750
description	flat filter H 27mm SS L 365mm W 270mm		
For models:	LP130		



1

Part No.	517493	Ref. No.	00079360
description	flat filter H 35mm SS L 577mm W 225mm		
For models:	ETE20, ETE21, ETE25, ETE27		



1

Part No.	511583	Ref. No.	00018042
description	flat filter L 257mm W 294mm		
For models:	C44, C44dgt, C44dgt-elt, C66, C66dgt, C66dgt-elt, C77		



1

Part No.	517492	Ref. No.	00065288
description	intake filter H 142mm SS L 130mm W 93mm		
For models:	LP130, LP70		





			
1			
Part No.	511850	Ref. No.	00012735
description	intake filter ø 225mm		
For models:	C33, CW650-15, CW650-16, CW650-35, CW650-36, D40, D40ELT, D40ELT-BT-BA, D40i, D40i-ELT-BT-BA, D80		

			
1			
Part No.	511847	Ref. No.	00222030
description	intake filter suction ø 205mm		
For models:	BD14, BD14alt		

			
1			
Part No.	511825	Ref. No.	00200500
description	round filters ø 115mm H 55mm		
For models:	42, 42E, 48, 48E, 55, 55E, B11, B15, BD11, BD13, BD14, BD46, BD47, BE35, BE40		

			
1			
Part No.	511849	Ref. No.	00013773
description	round filters ø 145mm H 107mm		
For models:	D30, D35, D36, D40, D40ELT, D40ELT-BT-BA, D40i, D40i-BT-BA, D40i-ELT-BT-BA, D45, D80		

			
1			
Part No.	511845	Ref. No.	00018301
description	round filters ø 145mm H 150mm		
For models:	C33, C34, C34dgt, C44, C44dgt, C44dgt-elt, C66, C66dgt, C66dgt-elt, CE24, CW650-15, CW650-16, CW650-35, CW650-36, D80, D80F, D85		

			
1			
Part No.	511089	Ref. No.	00002060
description	round filters ø 160mm		
For models:	120, 160, 240, 885, 906, 908, C44, C66		

			
1			
Part No.	517485	Ref. No.	00222665
description	round filters ø 167mm H 112mm		
For models:	BD50, BE50, BE50T		

			
1			
Part No.	517484	Ref. No.	00065570
description	round filters ø 235mm H 180mm hole ø 56mm		
For models:	C77, D120, D120dgt, LP60, LP60H, LP61, LP61H		

			
1			
Part No.	511848	Ref. No.	00012724
description	round filters ø 81mm H 67mm		
For models:	B11, BD11, BD13, BD14, BD46		

			
1			
Part No.	511090	Ref. No.	00002000
description	round filters outflow		





			
1			
Part No.	511087	Ref. No.	00002010
description	round filters suction		

			
1			
Part No.	511091	Ref. No.	00002070
description	round filters suction		

overflow pipes

			
1			
Part No.	511209	Ref. No.	06160004
description	gasket ED \varnothing 32mm ID \varnothing 22mm thickness 5.5mm Qty 1 pcs		
For models:	120, 160, 240, 42, 42E, 48, 48E, 55, 55E, 60, 882, 885, 906, 908, SQ885, SQT80		

			
1			
Part No.	511834	Ref. No.	06160041
description	gasket \varnothing 33mm		
For models:	B11, B15, BD11, BD13, BD14, BD14alt, BD22, BD50, BE35, BE40, BE50, BE50T, C33, C34, C34dgt, C44, C44dgt, C44dgt-elt, C66, C66dgt, C66dgt-elt, C77, CW650-15, CW650-16, CW650-35, CW650-36, D120, D120dgt, D30, D35, D36, D40, D40ELT, D40ELT-BT-BA, D40i, D40i-BT-BA, D40i-ELT-BT-BA, D45, D80, D80F, D85, EN, ET, ET020, ETA, ETE20, ETE21, ETE25, ETE27, ETS15...(Other models you can see in the webshop)		

			
1			
Part No.	511093	Ref. No.	00002113 0000211C
description	gasket with 4 screw holes ID \varnothing 74mm ED \varnothing 116mm thickness 3mm		

			
1			
Part No.	503186	Ref. No.	00211052
description	overflow pipe L 130mm \varnothing 43mm		
For models:	B11, BD11, BD13, BD14, BD46, BE35, BE40		

			
1			
Part No.	511831	Ref. No.	00210937
description	overflow pipe L 140mm \varnothing 43mm		
For models:	B11, B15, BD11, BD13, BD14, BD46, BE35, BE40		
spare parts for	511831		
	Part No.	511834	Ref. No. 06160041
	gasket \varnothing 33mm		

			
1			
Part No.	511833 ¹	Ref. No.	00222045
description	overflow pipe L 180mm \varnothing 43mm		
For models:	BD14, BD14alt, BD47		

¹for drain pump

			
1			
Part No.	511832	Ref. No.	00222035
description	overflow pipe L 185mm \varnothing 43mm		
For models:	BD14, BD14alt, BD47		

1

Part No.	511840 ¹	Ref. No.	00013839
description	overflow pipe L 190mm ø 43mm		
For models:	BD22, D30, D35, D36, D40, D40ELT, D40ELT-BT-BA, D40i, D40i-BT-BA, D40i-ELT-BT-BA, D45		
accessories for	511840		
	Part No.	511834	Ref. No. 06160041
	gasket ø 33mm		

¹for drain pump



1

Part No.	511839	Ref. No.	00012718
description	overflow pipe L 195mm ø 43mm		
For models:	BD22, D30, D35, D36, D40, D40ELT, D40ELT-BT-BA, D40i, D40i-BT-BA, D40i-ELT-BT-BA, D45		
accessories for	511839		
	Part No.	511834	Ref. No. 06160041
	gasket ø 33mm		



1

Part No.	511841	Ref. No.	00013994
description	overflow pipe L 225mm ø 43mm		
For models:	D80		



1

Part No.	511842	Ref. No.	00013997
description	overflow pipe L 225mm ø 43mm		
For models:	D80		



1

Part No.	511059	Ref. No.	00202132
description	overflow pipe L 230mm ø 37mm		
For models:	42, 42E, 48, 48E, 55, 55E, 60		



1

Part No.	511061	Ref. No.	00001950
description	overflow pipe L 230mm ø 37mm		



1

Part No.	511062	Ref. No.	00001960
description	overflow pipe L 230mm ø 37mm		



1

Part No.	511063	Ref. No.	00013110
description	overflow pipe L 230mm ø 37mm		
For models:	882, 885, SQ885, SQT80		





1



Part No.	511060	Ref. No.	00202136
description	overflow pipe L 230mm ø 37mm for drain pump		
For models:	42, 42E, 48, 48E, 55, 55E, 60		





			
1			
Part No.	511064	Ref. No.	00013115
description	overflow pipe L 230mm ø 37mm for drain pump		
For models:	120, 882, 885		

			
1			
Part No.	511387	Ref. No.	00014074
description	overflow pipe L 240mm ø 43mm		
For models:	BD50, BE50, BE50T, C33, CW650-15, CW650-16, CW650-35, CW650-36, D80, D80F, D85		
spare parts for	511387		
	Part No.	511834	Ref. No. 06160041
	gasket ø 33mm		

			
1			
Part No.	517499	Ref. No.	00222670
description	overflow pipe L 240mm ø 43mm		
For models:	BD50, BE50, BE50T		

			
1			
Part No.	511844	Ref. No.	00018271
description	overflow pipe L 315mm ø 43mm		
For models:	C34, C34dgt, C44, C44dgt, C44dgt-elt, C66, C66dgt, C66dgt-elt, CE24		
spare parts for	511844		
	Part No.	511834	Ref. No. 06160041
	gasket ø 33mm		

			
1			
Part No.	517489	Ref. No.	00065554
description	overflow pipe L 350mm ø 43mm		
For models:	C44, C66, C77, D120, D120dgt, LP60, LP60H, LP61, LP61H		

			
1			
Part No.	518625	Ref. No.	00065375
description	overflow pipe L 390mm ø 38mm		
For models:	LP130, LP70		

			
1			
Part No.	511065	Ref. No.	00013100
description	overflow pipe ø 37mm		
For models:	120, 160, 240, 906, 908		

			
1			
Part No.	511066	Ref. No.	00013105
description	overflow pipe ø 37mm		
For models:	120, 906, 908		

containers

dosing containers

			
1			
Part No.	511162	Ref. No.	00003730
description	drawer for rinse aid		
accessories for	511162		
	Part No.	511163	Ref. No. 00003731 373A
	screw for rinse aid container		

1

Part No.	361739	Ref. No.	00003740
description	rinse aid container		



1

Part No.	511126	Ref. No.	00011060
description	rinse aid container		
For models:	120, 160, 240, 882, 885, 904, 906, 908, 912		

salt tanks

1

Part No.	511895	Ref. No.	12145002
description	salt tank		
For models:	42, 42E, 48, 48E, 55, 60		

accessories



1

Part No.	511487	Ref. No.	00011053
description	funnel		
For models:	42, 42E, 48, 48E, 55, 55E, 60		



1

Part No.	511163	Ref. No.	00003731 373A
description	screw for rinse aid container		
For models:	ES400, ES400-alt, ES400-sehr-alt, MRS400, MRS400-alt		

boilers

boilers for dishwashers

1

Part No.	511899	Ref. No.	00013771
description	boiler		
For models:	CE24, D30, D80		



1

Part No.	511901	Ref. No.	00003440
description	boiler		





1

Part No.	511896	Ref. No.	00211009
description	boiler ø 120mm L 270mm		
For models:	B11, B15, BD11, BE35, BE40		





			
1			
Part No.	511898	Ref. No.	00210410
description	boiler ø 140mm L 270mm		
For models:	42, 42E, 48, 48E, 55, 55E, 60		

			
1			
Part No.	511897	Ref. No.	00222040
description	boiler ø 140mm L 270mm flange 4 hole inlet ø 50		
For models:	BD13, BD14, BD14alt, BD22, BD46, BD47, BD50, BE50, BE50T		

			
1			
Part No.	511900	Ref. No.	00010500 00065312
description	boiler ø 170mm L 440mm		
For models:	120, 160, 240, 882, 885, 904, 906, 908, 912, C33, C34, C34dgt, C44, C44dgt, C44dgt-elt, C66, C66dgt, C66dgt-elt, C77, CE24, CW650-15, CW650-16, CW650-35, CW650-36, D120, D120dgt, D30, D35, D36, D40, D40ELT, D40ELT-BT-BA, D40i, D40i-ELT-BT-BA, D45, D80, D80F, D85, LP60, LP60H, LP61, LP61H, LP70		

accessories

			
1			
Part No.	699274	Ref. No.	00010514
description	connecting fitting for boiler thread 1/2" L 75mm W 32mm hose ø 14/5mm		
For models:	BD46, BD47, BE35, BE40, BE50, BE50T, C34, C44dgt, C44dgt-elt, C66dgt, C66dgt-elt, CE24, D120dgt, D36, D45, D85, LP61, LP61H, LP70		

			
1			
Part No.	511817	Ref. No.	00010502
description	T-piece connection 1/4" ET - 1/2" IT hose ø 13mm 1/4" ET - 1/2" IT hose ø 13mm		
For models:	120, 160, 240, 882, 885, 904, 906, 908, 912, B11, B15, BD11, BD13, BD14, BD14alt, BD22, BD46, BD47, BD50, BE35, BE40, BE50, C33, C34, C34dgt, C44, C44dgt, C66, C66dgt, C77, D120, D30, D35, D36, D40, D40ELT, D40ELT-BT-BA, D40i, D40i-ELT-BT-BA, D45, D80, D80F, D85, LP60, LP60H, LP61, LP61H, SQ885, SQT80		

rotation plates

rotation plate bearings

			
1			
Part No.	519419	Ref. No.	00005491
description	spindle for rotation plate ø 47mm		
For models:	120, 160, 240, 882, 885, 908		

softener cartridges

softening columns

			
1			
Part No.	530000	Ref. No.	12145001
description	softener 4-fold L 380mm W 180mm		

			
1			
Part No.	530001	Ref. No.	12145001
description	softener 4-fold L 380mm W 180mm		
For models:	42, 42E, 48, 48E, 55, 55E, 60, B11, BD11, BD13, BD14, BD14alt, BD22, BD50, BE35, BE40, BE50, BE50T, D35, D36, D40, D40ELT, D40ELT-BT-BA, D40i, D40i-BT-BA, D40i-ELT-BT-BA, D45		

housing and bezels

fascias

			
1			
Part No.	403262	Ref. No.	00222433
description	control panel warewashing BE35 W 178mm H 48mm D 58mm suitable for ELFRAMO		
For models:	BD50, BE35, BE40, BE50		



miscellaneous



1

Part No.	692476	Ref. No.	00222460
description	spacer for lid L 43mm ID ø 5mm ED ø 24.6mm thickness 2.7mm		
For models:	BD50, BE35, BE40, BE50		

hood mechanics for dishwashers

bolts



1

Part No.	511888	Ref. No.	00018051
description	screw bolt hood mechanics		
For models:	C33, C34, C34dgt, C44, C44dgt, C44dgt-elt, C66, C66dgt, C66dgt-elt, C77, CE24, CW650-15, CW650-16, CW650-35, CW650-36		

springs



1

Part No.	511623	Ref. No.	00002320
description	spring for hood mechanics		



1

Part No.	511625	Ref. No.	00002330
description	spring for hood mechanics		

hood handles



1

Part No.	701464	Ref. No.	00018661
description	hood handle L 870mm W 705mm		
For models:	C34, C34dgt, C44dgt, C44dgt-elt, C66dgt, C66dgt-elt, CE24		

hood handle supports



1

Part No.	511560	Ref. No.	00018030 00018049 00018165
description	handle holder hood mechanics H 42mm ø 90mm		
For models:	C33, C34, C34dgt, C44, C44dgt, C44dgt-elt, C66, C66dgt, C66dgt-elt, C77, CE24, CW650-15, CW650-16, CW650-35, CW650-36		

rollers



1

Part No.	511876	Ref. No.	00013784
description	roller ED ø 40mm ID ø 11mm		
For models:	BD14, BD14alt, BD22, BD46, BD47, D36, D40, D40ELT, D40ELT-BT-BA, D40i, D40i-BT-BA, D40i-ELT-BT-BA, D45, D80, D80F, D85		



1

Part No.	511595	Ref. No.	00065842
description	roller set ø 30mm H 24mm for dishwasher hole ø 15mm		
For models:	LP130		



cable controls



1

Part No.	511118	Ref. No.	00000235 00002350
description	cable control foot switch for hood		



1

Part No.	511152	Ref. No.	00002370
description	hauling cable L 900mm hood mechanics		

miscellaneous



1

Part No.	511887	Ref. No.	00018050
description	bush hood mechanics		
For models:	C33, C34, C34dgt, C44, C44dgt, C44dgt-elt, C66, C66dgt, C66dgt-elt, C77, CE24, CW650-15, CW650-16, CW650-35, CW650-36		



1

Part No.	511885	Ref. No.	00018026
description	handle holder hood mechanics		
For models:	C33, C34, C34dgt, C44, C44dgt, C44dgt-elt, C66, C66dgt, C66dgt-elt, C77, CE24, CW650-15, CW650-16, CW650-35, CW650-36		



1

Part No.	511886	Ref. No.	00018021
description	roller hood mechanics		
For models:	C33, C34, C34dgt, C44, C44dgt, C44dgt-elt, C66, C66dgt, C66dgt-elt, C77, CE24, CW650-15, CW650-16, CW650-35, CW650-36, GFP25, GFP25AC, GFU25, GFU25AC		

basket guides

guide bars



1

Part No.	699273	Ref. No.	00073240
description	guide for rack conveyor dishwashing machine L 50mm W 45mm H 80mm with rollers		
For models:	ET, ET020, ETA, ETE20, ETE21, ETE25, ETE27		

basket holders



1

Part No.	971059	Ref. No.	00018060 00018404
description	basket support L 640m W 560mm H 110mm		
For models:	C34, C34dgt, C44, C44dgt, C44dgt-elt, C66, C66dgt, C66dgt-elt, CE24		

air traps

air traps



1

Part No.	511067	Ref. No.	00002180 00011350 00205750
description	air trap		
For models:	120, 160, 240, 904, 906, 908, 912, C34, C34dgt, C44, C44dgt, C44dgt-elt, C66, C66dgt, C66dgt-elt, C77, D120, D120dgt, EN, ET, ET020, ETA, ETE20, ETE21, ETE25, ETE27, ETS15, LP130, LP60, LP60H, LP61, LP61H, LP70, LPE100, LPE145		

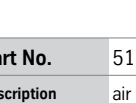

			
1			
Part No.	511069	Ref. No.	00205750
description	air trap		
For models:	42, 42E, 48, 48E, 55, 55E, 60, B11, B15		

			
1			
Part No.	511820	Ref. No.	00012716
description	air trap		
For models:	BD14alt, D30, D40		

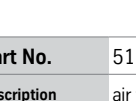
			
1			
Part No.	511821	Ref. No.	00013984
description	air trap		

			
1			
Part No.	511824	Ref. No.	00013984 00014098 00014099
description	air trap		
For models:	B11, BD11, BD13, BD14, BD22, BD46, BD47, BE35, BE40, D30, D35, D36, D40, D40i, D40i-BT-BA, D45, D80		

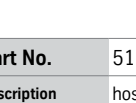

			
1			
Part No.	519465	Ref. No.	00014086 00014087
description	air trap ø 45mm H 160mm thread 3/8" hose ø 6mm		
For models:	C33, D80, D80F, D85		

air trap accessories			
			
1			
Part No.	511823	Ref. No.	00012719
description	hose connector		
For models:	BD14alt, D30, D40		

mechanics for flight type dishwashers			
			
1			
Part No.	532687	Ref. No.	00049050
description	tappet L 115mm W 68mm hole ø 8.5mm		

backflow preventers			
			
1			
Part No.	504140	Ref. No.	23180203
description	backflow preventer		

			
1			
Part No.	511124	Ref. No.	23180200 23180202
description	backflow preventer dishwasher		
For models:	120, 160, 240, 42, 42E, 48, 48E, 55, 55E, 60, 882, 885, 904, 906, 908, 912, B11, B15, BD14alt, C33, C44, C66, D120, D30, D40, D80, LP130, LP60, LP70		

			
1			
Part No.	516101	Ref. No.	23180203
description	backflow preventer dishwasher hose ø 12mm		
For models:	B11, BD13, BD14, BD46, BD47, BD50, BE35, BE40, BE50, BE50T, C33, C34, C34dgt, C44, C44dgt, C44dgt-elt, C66, C66dgt, C66dgt-elt, C77, CE24, D120, D120dgt, D30, D35, D36, D40, D40ELT, D40ELT-BT-BA, D40i, D40i-BT-BA, D40i-ELT-BT-BA, D45, D80, D85, LP130, LP60, LP60H, LP61, LP61H, LP70		
spare parts for	516101		
	Part No.	506367	Ref. No. —
	flat gasket rubber ED ø 40mm ID ø 28mm thickness 1.8mm Qty 1 pcs		



door mechanics

springs

roller springs



1

Part No.	519550	Ref. No.	00079740
description	roller spring W 25.35mm		
For models:	ETE20, ETE21, ETE25, ETE27		



1

Part No.	519491	Ref. No.	00079730
description	roller spring W 26mm		
For models:	ETE20, ETE21, ETE25, ETE27, ETS15, LP130, LP60H, LP61H, LP70		



1

Part No.	519543	Ref. No.	00065816
description	roller spring with holder W 46mm ID ømm lug lengthmm		
For models:	LP130, LP60, LP60H, LP61, LP61H		

linkage



1

Part No.	698783	Ref. No.	00073630
description	door pin		
For models:	ET, ET020, ETA		



1

Part No.	511906	Ref. No.	00210993
description	door pin L 210mm tie bar		
For models:	B11		



1

Part No.	511881	Ref. No.	00210366
description	door pin mounting pos. left complete tie bar		
For models:	42, 42E, 48, 48E, 55, 55E		



1

Part No.	698784	Ref. No.	00073640
description	door pin mounting pos. upper		
For models:	ET, ET020, ETA		

1

Part No.	511872	Ref. No.	00210940
description	tie bar		
For models:	B15, BD11, BD13, BD14, BD14alt, BD22, D120, D30, D40, D80, D80F		



1

Part No.	511884	Ref. No.	00001710
description	tie bar complete		
For models:	120, 160, 885, 904, 906, 908, 912, SQ885, SQT80		



1 

Part No.	511871	Ref. No.	00210983
description	tie bar L 260mm		
For models:	B11, BD13, BD14, BD22, BD50, BE50, BE50T, D120, D120dgt, D30, D35, D36, D40, D40ELT, D40ELT-BT-BA, D40i, D40i-BT-BA, D40i-ELT-BT-BA, D45, D80, D85		

2

Part No.	511883	Ref. No.	00010730
description	tie bar mounting pos. left complete		
For models:	120, 160, 240, 42, 42E, 48, 48E, 55, 55E, 60, 882, 885		

1 

Part No.	511880	Ref. No.	00210361
description	tie bar mounting pos. right complete		
For models:	42, 42E, 48, 48E, 55, 55E		

1 

Part No.	511882	Ref. No.	00010720
description	tie bar mounting pos. right complete		
For models:	120, 160, 240, 42, 42E, 48, 48E, 55, 55E, 60, 882, 885		

threaded shafts

1 

Part No.	511879	Ref. No.	00210939
description	threaded part threaded part		
For models:	B11, B15, BD11, BD13, BD14, BD14alt, BD22, BD50, BE50, BE50T, D120, D120dgt, D30, D35, D36, D40, D40ELT, D40ELT-BT-BA, D40i, D40i-BTBA, D40i-ELT-BT-BA, D45, D80, D80F, D85		

sliding plates

1 

Part No.	511907	Ref. No.	00013777
description	sliding plate		
For models:	BD14, BD14alt, D120, D120dgt, D30, D40, D80		

1 

Part No.	511878	Ref. No.	00013780
description	sliding plate sliding plate		
For models:	BD14, BD14alt, D30, D40, D80		

rollers

1 

Part No.	501445	Ref. No.	00041907
description	roller ED ø 23.7mm for door shaft diameter 8mm		
For models:	EN, ET, ETE20, ETA, LPE100, LPE145		

1 

Part No.	501431	Ref. No.	00013907
description	roller ED ø 9mm for door mechanism shaft diameter 3.5mm W 5mm		
For models:	BD14, BD14alt, BD22, BD46, BD47, D35, D36, D40, D40ELT, D40ELT-BTBA, D40i, D40i-BT-BA, D40i-ELT-BT-BA, D45, D80, D80F, D85, ET, ETE20, ETE21, ETE25, ETE27, ETS15		

hinges

1 

Part No.	519417	Ref. No.	00065309
description	door hinge		
For models:	D120, LP130, LP60, LP60H, LP61, LP61H, LP70		

1 

Part No.	511866	Ref. No.	00210902
description	door hinge door hinge left mounting pos. left		
For models:	B11, B15		



			
1			
Part No.	511874	Ref. No.	00013744
description	door hinge door hinge left mounting pos. left		
For models:	BD14, BD14alt, BD22, D36, D40, D40ELT, D40ELT-BT-BA, D40i, D40i-BTBA, D40i-ELT-BT-BA, D45, D80, D80F, D85		

			
1			
Part No.	511865	Ref. No.	00210903
description	door hinge door hinge right mounting pos. right		
For models:	B11, B15		

			
1			
Part No.	511873	Ref. No.	00013743
description	door hinge door hinge right mounting pos. right		
For models:	BD14, BD14alt, BD22, D36, D40, D40ELT, D40ELT-BT-BA, D40i, D40i-BTBA, D40i-ELT-BT-BA, D45, D80, D80F, D85		

			
1			
Part No.	504647	Ref. No.	00002509
description	door hinge hinge lever left mounting pos. left		

			
1			
Part No.	517781	Ref. No.	00222629
description	hinge for door mounting pos. left dishwasher L 130mm ELFRAMO W 32mm		
For models:	BD50, BE35, BE40, BE50, BE50T		

			
1			
Part No.	517780	Ref. No.	00222626
description	hinge for door mounting pos. right for dishwasher L 130mm H 32mm		
For models:	BD50, BE35, BE40, BE50, BE50T		

door guides

			
1			
Part No.	517496	Ref. No.	00065245
description	door guides L 460mm W 34mm H 25mm mounting pos. left/right		
For models:	LP130, LP60, LP60H, LP61, LP70		

door magnets

			
1			
Part No.	694539	Ref. No.	25110108
description	door magnet L 63mm W 7.5mm H 19mm mounting distance 52mm		
For models:	D120dgt		

door bumpers

			
1			
Part No.	511869	Ref. No.	00013791
description	door bumper end stop		
For models:	B11, B15, BD14, BD14alt, D120, D30, D40, D80		



locks



1

Part No.	511083	Ref. No.	00011040
description	counterpart door catch		
For models:	120, 160, 240, 42, 42E, 48, 48E, 55, 55E, 60, 882, 885, 904, 906, 908, 912, B11, B15, BD11, BD13, D120, D120dgt, D30, D35, SQ885, SQT80		





1

Part No.	511105	Ref. No.	00001670 00001680
description	counterpart door catch		



1

Part No.	511104	Ref. No.	00001630 00001640	
description	door catch			
accessories for	511104			
	Part No.	511105	Ref. No.	00001670 00001680
	counterpart door catch			



1

Part No.	511082	Ref. No.	00011028	
description	door catch complete catch			
For models:	120, 160, 240, 42, 42E, 48, 48E, 55, 55E, 60, 882, 885, 904, 906, 908, 912, B11, B15, BD11, BD13, D120, D120dgt, D30, D35, SQ885, SQT80			
accessories for	511082			
	Part No.	511083	Ref. No.	00011040
	counterpart door catch			

miscellaneous



1

Part No.	504648	Ref. No.	00013152
description	bush bush		



1

Part No.	530847	Ref. No.	00065595
description	cap for door handle ID ø 5mm D1 ø 21.7mm D2 ø 12.7mm		
For models:	ETE20, ETE21, ETE25, ETE27, LP130, LP60, LP60H, LP61, LP61H, LP70		



1

Part No.	524047	Ref. No.	00013786
description	hauling cable for door mechanism ø 1.5mm L 475mm		
For models:	BD22, BD46, BD47, D36, D40, D40ELT, D40ELT-BT-BA, D40i, D40i-BTBA, D40i-ELT-BT-BA, D45, D80, D80F		



1

Part No.	511877	Ref. No.	00222059
description	hauling cable hauling cable		
For models:	BD14, BD14alt, D80, D85		



1

Part No.	511868	Ref. No.	00013829
description	hinge complete hinge		
For models:	D120, D120dgt, D30		



1

Part No.	511594	Ref. No.	00220340
description	hinge for dishwasher door set D1 ø 20mm D2 ø 12mm		
For models:	B11, BD11, BD13, BD22, D30, D35		



1



Part No.	519408	Ref. No.	00013909
description	linkage guide for tie bar complete		
For models:	B11, BD11, BD13, BD14, BD22, BD50, BE50, BE50T, D120, D120dgt, D30, D35, D36, D40, D40ELT, D40ELT-BT-BA, D40i, D40i-BT-BA, D40i-ELT-BT-BA, D45, D80, D80F, D85		

1



Part No.	517782	Ref. No.	00001672
description	spring L 16.5mm mounting pos. for door guides D1 ø 9mm wire gauge ø 1.2mm		
For models:	BD50, BE35, BE40, BE50		

screw connections

1



Part No.	519409	Ref. No.	00013785
description	screw		
For models:	BD14, BD14alt, BD22, BD46, BD47, D36, D40, D40ELT, D40ELT-BT-BA, D40i, D40i-BT-BA, D40i-ELT-BT-BA, D45, D80, D80F, D85		

curtains

curtains

1

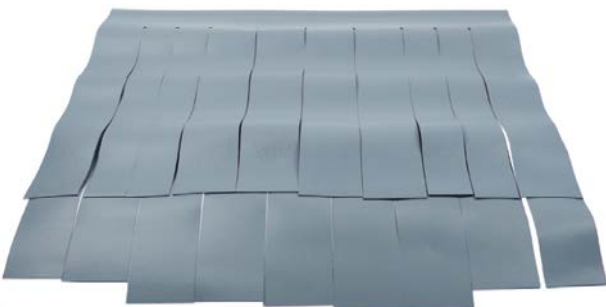

Part No.	533013	Ref. No.	00076010
description	curtain W 620mm H 550mm warewashing		
For models:	EN, ET, ET020, ETA, ETE20, ETE21, ETE25, ETE27, ETS15		

1



Part No.	533021	Ref. No.	00062000 00062030
description	curtain W 650mm H 450mm plastic thickness 1.5mm		
For models:	EN, ET, ET020, ETA, ETE20, ETE21, ETE25, ETE27, ETS15		

washing and rinsing systems

1



Part No.	511716	Ref. No.	00222102
description	null		
For models:	BD14, BD14alt, BD47, C33, CW650-15, CW650-16, CW650-35, CW650-36, D80, D85		

1



Part No.	511781	Ref. No.	00202632
description	rinse arm support mounting pos. upper		
For models:	42, 42E, 48, 48E, 55, 55E, 60, B11, B15, BD11, BE35		

1



Part No.	511728	Ref. No.	00018077
description	rinse pipe		
For models:	C44, C44dgt, C44dgt-elt, C66, C66dgt, C66dgt-elt, C77, D120, D120dgt, D30, D40		

1



Part No.	511730	Ref. No.	00014042
description	rinse pipe		
For models:	BD50, BE50, BE50T, C33, C34, C34dgt, CE24, CW650-15, CW650-16, CW650-35, CW650-36, D30, D35, D36, D40, D40ELT, D40ELT-BT-BA, D40i, D40i-BT-BA, D40i-ELT-BT-BA, D45, D80, D80F, D85		

1



Part No.	511732	Ref. No.	00013779
description	rinse pipe		
For models:	D30, D35, D40, D40ELT, D40ELT-BT-BA, D40i, D40i-BT-BA, D40i-ELTBT-BA		

1			
Part No.	517503	Ref. No.	00018038 00018261 00018352
description	rinse pipe L 770mm		
For models:	C34, C34dgt, C44, C44dgt, C44dgt-elt, C66, C66dgt, C66dgt-elt, C77, D120, D120dgt		



1			
Part No.	511720	Ref. No.	00211015
description	rinse pipe mounting pos. lower		
For models:	B11, B15, BD11, BD13, BD14, BD22, BD46, BE35, BE40		



1			
Part No.	511714	Ref. No.	00222103
description	rinse pipe mounting pos. upper		
For models:	B11, B15, BD11, BD13, BD14, BD14alt, BD22, BD46, BD47, BE35, BE40		



1			
Part No.	511624	Ref. No.	00005080
description	rinse pipe ø 10mm L 400mm connection 3/8"		
For models:	120, 240, C44, C66, C77, D120, D120dgt, LP130, LP60, LP60H, LP61, LP61H, LP70		



1			
Part No.	511016	Ref. No.	00005010
description	screw connection		
For models:	882, 885, LPE100, LPE145, SQ885, SQT80		



1			
Part No.	511741	Ref. No.	02120040
description	throttle disc		
For models:	C34, C34dgt, C44, C66, CE24, LP130, LP60, LP60H, LP61, LP61H, LP70		



1			
Part No.	511704	Ref. No.	00018076
description	Thumb screw		
For models:	B11, B15, BD11, BD13, BD14, BD14alt, BD22, BD46, BD47, BE35, BE40, BE50, C33, C34, C34dgt, C44, C44dgt, C44dgt-elt, C66, C66dgt, C66dgt-elt, C77, CE24, CW650-15, CW650-16, CW650-35, CW650-36, D120, D120dgt, D30, D36, D40, D40ELT, D40ELT-BT-BA, D45, D80, D80F, D85, LP130, LP60, LP60H, LP61, LP61H, LP70		



1			
Part No.	511484	Ref. No.	00000395 00003950
description	T-piece thread 1/4" H 82mm L 120mm		
For models:	SQ885, SQT80		



1			
Part No.	511713	Ref. No.	00222111
description	wash arm bearing		
For models:	BD13, BD14, BD14alt, BD22, BD46, BD47, BE40		



1			
Part No.	511729	Ref. No.	00014041
description	wash arm bearing		
For models:	BD50, BE50, BE50T, C33, C34, C34dgt, CE24, CW650-15, CW650-16, CW650-35, CW650-36, D30, D35, D36, D40, D40ELT, D40ELT-BT-BA, D40i, D40i-BT-BA, D40i-ELT-BT-BA, D45, D80, D80F, D85		



1			
Part No.	511592	Ref. No.	00011858 00014286
description	wash pipe L 730mm suitable for ELFRAMO		
For models:	BD50, BE50, BE50T, D30, D35, D36, D40, D40ELT, D40ELT-BT-BA, D40i, D40i-BT-BA, D40i-ELT-BT-BA, D45, D80		



1

Part No.	517505	Ref. No.	00018260
description	wash pipe L 870mm SS		
For models:	C44, C44dgt, C44dgt-elt, C66, C66dgt, C66dgt-elt, D120		



1

Part No.	511492	Ref. No.	00000511 00005110
description	wash pipe mounting pos. lower ø 34mm L 153mm		
For models:	882, 885, SQ885, SQT80		



1

Part No.	511493	Ref. No.	00000512 00005120
description	wash pipe mounting pos. lower ø 38mm L 176mm		
For models:	120, 160, 906, 908		



1

Part No.	511489	Ref. No.	00000514 00005140
description	wash pipe mounting pos. lower ø 39mm L 233mm		
For models:	240, C34, C34dgt, C44, C44dgt, C44dgt-elt, C66, C66dgt, C66dgt-elt, C77, CE24, D120, D120dgt, LP60, LP60H, LP61, LP61H		



1

Part No.	511491	Ref. No.	00000513 00005130
description	wash pipe ø 38mm L 214mm		
For models:	120, 160, 906, 908		

washing and rinsing systems (sorted by producer)

ELFRAMO



1

Part No.	511744	Ref. No.	00004570
description	wash arm L 190mm nozzles 1 thread 1"		



1

Part No.	511745	Ref. No.	00004580
description	wash arm L 190mm nozzles 1 thread 1"		



1

Part No.	510207	Ref. No.	00004930
description	wash jet complete		
For models:	882, 885, SQ885, SQT80		



1

Part No.	511747	Ref. No.	00004610
description	wash arm L 220mm nozzles 1 thread 1"		



1

Part No.	511746	Ref. No.	00004590
description	wash arm nozzles 1 thread 1"		





1

Part No.	510207	Ref. No.	00004930
description	wash jet complete		
For models:	882, 885, SQ885, SQT80		





 <p>1</p>			
Part No.	511028	Ref. No.	00202710
description	wash arm L 320mm nozzles 4 mounting ø 15/59mm mounting pos. lower		
For models:	42, 42E, 48, 48E, 55, 55E		
spare parts for	511028		
	Part No.	511757	Ref. No. 00202670
	wash arm L 135mm nozzles 1 mounting ø 19mm		
	Part No.	511758	Ref. No. 00202680
	wash arm L 135mm nozzles 1 mounting ø 19mm		
	Part No.	511759	Ref. No. 00202690
	wash arm L 135mm nozzles 1 mounting ø 19mm		
	Part No.	511760	Ref. No. 00202700
	wash arm L 135mm nozzles 1 mounting ø 19mm		
	Part No.	511770	Ref. No. 00202530
	spring		
	Part No.	511772	Ref. No. —
	wash jet		

 <p>1</p>			
Part No.	511770	Ref. No.	00202530
description	spring		
For models:	42, 42E, 48, 48E, 55, 55E, 60		

 <p>1</p>			
Part No.	511757	Ref. No.	00202670
description	wash arm L 135mm nozzles 1 mounting ø 19mm		
For models:	42, 42E, 48, 48E, 55, 55E		



 <p>1</p>			
Part No.	511758	Ref. No.	00202680
description	wash arm L 135mm nozzles 1 mounting ø 19mm		
For models:	42, 42E, 48, 48E, 55, 55E		

 <p>1</p>			
Part No.	511759	Ref. No.	00202690
description	wash arm L 135mm nozzles 1 mounting ø 19mm		
For models:	42, 42E, 48, 48E, 55, 55E		

 <p>1</p>			
Part No.	511760	Ref. No.	00202700
description	wash arm L 135mm nozzles 1 mounting ø 19mm		
For models:	42, 42E, 48, 48E, 55, 55E		

 <p>1</p>			
Part No.	511770	Ref. No.	00202530
description	spring		
For models:	42, 42E, 48, 48E, 55, 55E, 60		

 <p>1</p>			
Part No.	511761	Ref. No.	00202540
description	wash arm L 165mm nozzles 1 mounting ø 19mm		
For models:	42, 42E, 48, 48E, 55, 55E		

 <p>1</p>			
Part No.	511762	Ref. No.	00202550
description	wash arm L 165mm nozzles 1 mounting ø 19mm		
For models:	42, 42E, 48, 48E, 55, 55E		
spare parts for	511762		
	Part No.	511772	Ref. No. —
	wash jet		

 <p>1</p>			
Part No.	511763	Ref. No.	00202560
description	wash arm L 165mm nozzles 1 mounting ø 19mm		
For models:	42, 42E, 48, 48E, 55, 55E		





			
1			
Part No.	511029	Ref. No.	00202830
description	wash arm L 450mm nozzles 4 mounting ø 15/59mm mounting pos. lower		
For models:	42, 42E, 48, 48E, 55, 55E, 60		
spare parts for	511029		
	Part No.	511766	Ref. No. 00202800
	wash arm L 200mm nozzles 1 mounting ø 19mm		
	Part No.	511767	Ref. No. 00202810
	wash arm L 200mm nozzles 1 mounting ø 19mm		
	Part No.	511768	Ref. No. 00202820
	wash arm L 200mm nozzles 1 mounting ø 19mm		
	Part No.	511770	Ref. No. 00202530
	spring		
	Part No.	511772	Ref. No. —
	wash jet		

			
1			
Part No.	511770	Ref. No.	00202530
description	spring		
For models:	42, 42E, 48, 48E, 55, 55E, 60		

			
1			
Part No.	511766	Ref. No.	00202800
description	wash arm L 200mm nozzles 1 mounting ø 19mm		
For models:	42, 42E, 48, 48E, 55, 55E, 60		

			
1			
Part No.	511767	Ref. No.	00202810
description	wash arm L 200mm nozzles 1 mounting ø 19mm		
For models:	42, 42E, 48, 48E, 55, 55E, 60		

			
1			
Part No.	511768	Ref. No.	00202820
description	wash arm L 200mm nozzles 1 mounting ø 19mm		
For models:	42, 42E, 48, 48E, 55, 55E		

			
1			
Part No.	511791	Ref. No.	00011208
description	wash arm L 180mm nozzles 1 mounting ø 27mm		
For models:	120, 160, 906, 908		

			
1			
Part No.	511792	Ref. No.	00011209
description	wash arm L 180mm nozzles 1 mounting ø 27mm		
For models:	120, 160, 906, 908		

			
1			
Part No.	511793	Ref. No.	00011210
description	wash arm L 180mm nozzles 1 mounting ø 27mm		
For models:	120, 160, 906, 908		



			
1			
Part No.	511794	Ref. No.	00011211
description	wash arm L 180mm nozzles 1 mounting ø 27mm		
For models:	120, 160, 906, 908		

			
1			
Part No.	511074	Ref. No.	00011340
description	wash jet		
For models:	120, 160, 240, 906, 908, ET, ETA, ETE20, ETE21, ETE25, ETE27		







 <p>1</p>			
Part No.	510004	Ref. No.	00004940
description	wash jet thread 1" ø 59mm H 27mm		
For models:	120, 160, 240, 882, 885, 908		

 <p>1</p>			
Part No.	511074	Ref. No.	00011340
description	wash jet		
For models:	120, 160, 240, 906, 908, ET, ETA, ETE20, ETE21, ETE25, ETE27		

 <p>1</p>			
Part No.	511022	Ref. No.	00011222
description	wash arm mounting pos. lower		
For models:	120, 160, 240, 906, 908		
spare parts for	511022		
	Part No.	511074	Ref. No. 00011340
	wash jet		
	Part No.	511795	Ref. No. 00011180
	wash arm L 200mm nozzles 1 mounting ø 27mm		

 <p>1</p>			
Part No.	510004	Ref. No.	00004940
description	wash jet thread 1" ø 59mm H 27mm		
For models:	120, 160, 240, 882, 885, 908		

 <p>1</p>			
Part No.	511800	Ref. No.	00011259
description	wash arm L 220mm nozzles 1 mounting ø 27mm		
For models:	240		

 <p>1</p>			
Part No.	511021	Ref. No.	00011221
description	wash arm mounting pos. upper		
For models:	120, 160, 906, 908		
spare parts for	511021		
	Part No.	511074	Ref. No. 00011340
	wash jet		
	Part No.	511795	Ref. No. 00011180
	wash arm L 200mm nozzles 1 mounting ø 27mm		

 <p>1</p>			
Part No.	511802	Ref. No.	00011261
description	wash arm L 220mm nozzles 1 mounting ø 27mm		
For models:	240		

 <p>1</p>			
Part No.	511799	Ref. No.	00011258
description	wash arm L 220mm nozzles 2 mounting ø 27mm		
For models:	240		

 <p>1</p>			
Part No.	511795	Ref. No.	00011180
description	wash arm L 200mm nozzles 1 mounting ø 27mm		
For models:	120, 160, 906, 908		

 <p>1</p>			
Part No.	511801	Ref. No.	00011260
description	wash arm L 220mm nozzles 2 mounting ø 27mm		
For models:	240		





			
1			
Part No.	511074	Ref. No.	00011340
description	wash jet		
For models:	120, 160, 240, 906, 908, ET, ETA, ETE20, ETE21, ETE25, ETE27		

			
1			
Part No.	510004	Ref. No.	00004940
description	wash jet thread 1" ø 59mm H 27mm		
For models:	120, 160, 240, 882, 885, 908		

			
1			
Part No.	511800	Ref. No.	00011259
description	wash arm L 220mm nozzles 1 mounting ø 27mm		
For models:	240		

			
1			
Part No.	511802	Ref. No.	00011261
description	wash arm L 220mm nozzles 1 mounting ø 27mm		
For models:	240		

			
1			
Part No.	511799	Ref. No.	00011258
description	wash arm L 220mm nozzles 2 mounting ø 27mm		
For models:	240		

			
1			
Part No.	511074	Ref. No.	00011340
description	wash jet		
For models:	120, 160, 240, 906, 908, ET, ETA, ETE20, ETE21, ETE25, ETE27		

			
1			
Part No.	510004	Ref. No.	00004940
description	wash jet thread 1" ø 59mm H 27mm		
For models:	120, 160, 240, 882, 885, 908		

			
1			
Part No.	511813	Ref. No.	00004520
description	wash arm L 170mm nozzles 1 thread 3/4"		
For models:	882, 885, SQ885, SQT80		

			
1			
Part No.	511814	Ref. No.	00004530
description	wash arm L 195mm nozzles 1 thread 3/4"		
For models:	882, 885, SQ885, SQT80		

			
1			
Part No.	511811	Ref. No.	00004500
description	wash arm L 200mm nozzles 1 thread 3/4"		
For models:	882, 885, SQ885, SQT80		

			
1			
Part No.	511812	Ref. No.	00004510
description	wash arm L 200mm nozzles 1 thread 3/4"		
For models:	882, 885, SQ885, SQT80		

			
1			
Part No.	511810	Ref. No.	00004320
description	wash arm boss		
For models:	882, 885, SQ885, SQT80		

			
1			
Part No.	510207	Ref. No.	00004930
description	wash jet complete		
For models:	882, 885, SQ885, SQT80		





1 			
Part No.	510163	Ref. No.	ALT siehe 511.075/76
description	rinse jet		

1 			
Part No.	511756	Ref. No.	00004950
description	rinse jet		
For models:	882, 885, SQ885, SQT80		

1 			
Part No.	511805	Ref. No.	00004820 00011186
description	rinse arm L 215mm nozzles 2 thread 1/4"		
For models:	120, 160, 882, 885, 906, 908		



1 			
Part No.	511806	Ref. No.	00004770 00011187
description	rinse arm L 215mm nozzles 2 thread 1/4"		
For models:	120, 160, 882, 885, 906, 908, SQ885, SQT80		

1 			
Part No.	510163	Ref. No.	ALT siehe 511.075/76
description	rinse jet		

1 			
Part No.	511756	Ref. No.	00004950
description	rinse jet		
For models:	882, 885, SQ885, SQT80		

1 			
Part No.	510163	Ref. No.	ALT siehe 511.075/76
description	rinse jet		

1 			
Part No.	511756	Ref. No.	00004950
description	rinse jet		
For models:	882, 885, SQ885, SQT80		

1 			
Part No.	511773	Ref. No.	00202720
description	rinse arm L 315mm nozzles 4 mounting ø 14mm mounting pos. upper/lower		
For models:	42, 42E, 48, 48E, 55, 55E		
spare parts for	511773		
	Part No.	511039	Ref. No. 00011166
	rinse arm shaft		
	Part No.	511775	Ref. No. 00202730
	rinse arm L 130mm nozzles 2 thread 1/4"		

1 			
Part No.	511775	Ref. No.	00202730
description	rinse arm L 130mm nozzles 2 thread 1/4"		
For models:	42, 42E, 48, 48E, 55, 55E		

1 			
Part No.	510163	Ref. No.	ALT siehe 511.075/76
description	rinse jet		

1 			
Part No.	511756	Ref. No.	00004950
description	rinse jet		
For models:	882, 885, SQ885, SQT80		





1 			
Part No.	511774	Ref. No.	00202600
description	rinse arm L 375mm nozzles 4 mounting ø 14mm mounting pos. upper		
For models:	42, 42E, 48, 48E, 55, 55E		
spare parts for	511774		
	Part No.	511039	Ref. No. 00011166
	rinse arm shaft		

Table continues overleaf





spare parts for	511774		
	Part No.	511777	Ref. No. 00202610
	rinse arm L 163mm nozzles 2 thread 1/4"		

1 			
Part No.	511777	Ref. No.	00202610
description	rinse arm L 163mm nozzles 2 thread 1/4"		
For models:	42, 42E, 48, 48E, 55, 55E		

1 			
Part No.	511778	Ref. No.	00202620
description	rinse arm L 163mm nozzles 2 thread 1/4"		
For models:	42, 42E, 48, 48E, 55, 55E		

1 			
Part No.	510163	Ref. No.	ALT siehe 511.075/76
description	rinse jet		

1 			
Part No.	511756	Ref. No.	00004950
description	rinse jet		
For models:	882, 885, SQ885, SQT80		

1 			
Part No.	510163	Ref. No.	ALT siehe 511.075/76
description	rinse jet		



1 			
Part No.	511756	Ref. No.	00004950
description	rinse jet		
For models:	882, 885, SQ885, SQT80		

1 			
Part No.	511805	Ref. No.	00004820 00011186
description	rinse arm L 215mm nozzles 2 thread 1/4"		
For models:	120, 160, 882, 885, 906, 908		

1 			
Part No.	511806	Ref. No.	00004770 00011187
description	rinse arm L 215mm nozzles 2 thread 1/4"		
For models:	120, 160, 882, 885, 906, 908, SQ885, SQT80		

1 			
Part No.	510163	Ref. No.	ALT siehe 511.075/76
description	rinse jet		

1 			
Part No.	511756	Ref. No.	00004950
description	rinse jet		
For models:	882, 885, SQ885, SQT80		



1 			
Part No.	511026	Ref. No.	00011241
description	rinse arm L 545mm nozzles 4 mounting ø 14mm complete		
For models:	240		
spare parts for	511026		
	Part No.	511039	Ref. No. 00011166
	rinse arm shaft		

1 			
Part No.	510163	Ref. No.	ALT siehe 511.075/76
description	rinse jet		

1 			
Part No.	511756	Ref. No.	00004950
description	rinse jet		
For models:	882, 885, SQ885, SQT80		



1

Part No.	511041	Ref. No.	00210015
description	wash arm L 328mm nozzles 3 mounting pos. upper thread 3/4"		
For models:	42, 42E, 48, 48E, 55, 55E		
spare parts for	511041		
	Part No.	505073	Ref. No. 06140005
	O-ring EPDM thickness 2.62mm ID ø 20.63mm Qty 1 pcs		
	Part No.	511772	Ref. No. —
	wash jet		



1

Part No.	511496	Ref. No.	00220398
description	rinse arm L 325mm nozzles 4 W 35mm		
For models:	BE35		







1

Part No.	511042	Ref. No.	00210016
description	wash arm L 365mm nozzles 3 mounting pos. upper thread 3/4"		
For models:	42, 42E, 48, 48E, 55, 55E		
spare parts for	511042		
	Part No.	505073	Ref. No. 06140005
	O-ring EPDM thickness 2.62mm ID ø 20.63mm Qty 1 pcs		
	Part No.	511772	Ref. No. —
	wash jet		



1

Part No.	511703	Ref. No.	00222083 00222122 00222127
description	rinse arm L 380mm nozzles 4 mounting ø 12mm mounting pos. upper/lower		
For models:	BD13, BD14, BD14alt, BD46, BD47, BE40		
spare parts for	511703		
	Part No.	511704	Ref. No. 00018076
	Thumb screw		
	Part No.	511705	Ref. No. 00018106
	disc		
	Part No.	511706	Ref. No. 00018228
	knurled nut		
	Part No.	511707	Ref. No. 00014555 00018083 00018084
	rinse jet ø 8mm H 10mm WS		



1

Part No.	511701	Ref. No.	00220395
description	rinse arm L 325mm nozzles 4 mounting ø 12mm mounting pos. upper/lower		
For models:	B11, BE35		



1

Part No.	511480	Ref. No.	00014194
description	rinse arm L 500mm nozzles 6		
For models:	C33, C44, C44dgt, C66, C66dgt, C77, D35, D40i, D40i-BT-BA, D40i-ELTBT-BA, D80		



1



Part No.	511909	Ref. No.	00011214
description	wash and rinse arm conversion kit for ELFRAMO Mod. 120		

1



Part No.	511700	Ref. No.	00211010
description	wash arm L 350mm nozzles 7 mounting \varnothing 14/39.5mm mounting pos. upper/lower		
For models:	B11, B15, BD11, BE35		

1



Part No.	511702	Ref. No.	00222000
description	wash arm L 400mm nozzles 8 mounting \varnothing 15/39.5mm mounting pos. upper/lower		
For models:	BD13, BD14, BD14alt, BD46, BD47, BE40		

1



Part No.	511723	Ref. No.	00014045 00018287
description	wash arm L 484mm nozzles 8 mounting \varnothing 15/46mm mounting pos. upper/lower		
For models:	BD50, BE50, BE50T, D30, D35, D36, D40, D40ELT, D40ELT-BT-BA, D40i, D40i-BT-BA, D40i-ELT-BT-BA, D45		

1



Part No.	511724	Ref. No.	00014048
description	wash arm L 485mm nozzles 11 mounting \varnothing 15/46mm mounting pos. upper/lower		
For models:	BD50, BE50, C33, C34, C34dgt, CE24, CW650-15, CW650-16, CW650-35, CW650-36, D80, D80F, D85		

1



Part No.	511588	Ref. No.	00018286
description	wash arm L 485mm nozzles 11 mounting \varnothing 15/60mm mounting pos. upper/lower		

1



Part No.	511737	Ref. No.	00016851 00018190
description	wash arm L 535mm nozzles 10 mounting \varnothing 15/60mm mounting pos. upper/lower		
For models:	C44, C44dgt, C44dgt-elt, C66, C66dgt, C66dgt-elt, C77, D120, D120dgt		

1



Part No.	511921	Ref. No.	00052010
description	wash arm L 655mm nozzles 24 mounting \varnothing 15/80mm mounting pos. upper/lower		
For models:	LP130, LP70		

1



Part No.	511924	Ref. No.	00011216
description	wash arm mounting pos. upper and bottom conversion kit for ELFRAMO Mod. 160		

1



Part No.	517497	Ref. No.	00222005
description	wash arm mounting pos. upper/lower L 460mm nozzles 10		
For models:	BD22		





			
1			
Part No.	517500	Ref. No.	00065336
description	wash arm boss mounting pos. upper/lower ø 99mm H 74mm		
For models:	LP130, LP60, LP60H, LP61, LP61H, LP70		

			
1			
Part No.	511725	Ref. No.	00018406
description	rinse arm complete		
For models:	C33, C44, C66, C77, D30, D40, D40ELT, D40ELT-BT-BA, D80		

			
1			
Part No.	511551	Ref. No.	00018155 00222295
description	rinse arm L 480mm nozzles 6 mounting ø 12mm mounting pos. upper/lower		
For models:	BD22, BE50, BE50T, C33, C34, C34dgt, C44, C44dgt, C44dgt-elt, C66, C66dgt, C66dgt-elt, CE24, CW650-15, CW650-16, CW650-35, CW650-36, D30, D36, D40, D45, D80, D80F, D85		
spare parts for	511551		
	Part No.	511704	Ref. No. 00018076
Thumb screw			
	Part No.	511705	Ref. No. 00018106
disc			
	Part No.	511706	Ref. No. 00018228
knurled nut			

			
1			
Part No.	517486	Ref. No.	00079318 00090793 00090821 00095071
description	rinse arm L 580mm nozzles 4		
For models:	ETE20, ETE21, ETE25, ETE27, ETS15		

			
1			
Part No.	519490	Ref. No.	00065294 00065435
description	rinse arm L 665mm nozzles 7 mounting ø 12mm mounting pos. upper/lower W 29mm		
For models:	LP130, LP70		

			
1			
Part No.	517487	Ref. No.	00065625
description	rinse arm mounting pos. upper/lower L 550mm nozzles 6 thread M10x1.5		
For models:	C77, D120, D120dgt, LP60, LP60H, LP61, LP61H		

			
1			
Part No.	511707	Ref. No.	00014555 00018083 00018084
description	rinse jet ø 8mm H 10mm WS		
For models:	B11, B15, BD11, BD13, BD14, BD14alt, BD22, BD50, BE40, BE50, BE50T, C33, C34, C34dgt, C44, C44dgt, C44dgt-elt, C66, C66dgt, C66dgt-elt, C77, CE24, CW650-15, CW650-16, CW650-35, CW650-36, D120, D120dgt, D30, D36, D40, D40ELT, D40ELT-BT-BA, D45, D80, D80F, D85, EN, ET, ET020, ETE20, ETE21, ETE25, ETE27, ETS15, LP130, LP60, LP60H, LP61, LP61H... (Other models you can see in the webshop)		

			
1			
Part No.	511586	Ref. No.	00072360
description	rinse arm L 636mm nozzles 7 mounting pos. upper/lower thread 3/4"		
For models:	EN, ET, ETA		





			
1			
Part No.	511587	Ref. No.	00052150 00072350
description	rinse arm L 638mm nozzles 7 mounting pos. left thread 3/4"		
For models:	EN, ET, ET020, ETA		

			
1			
Part No.	511072	Ref. No.	00004960 old version
description	rinse jet		

			
1			
Part No.	511621	Ref. No.	00000496 00004960 00007237 00072370
description	rinse jet rinse jet ID ø 2.5mm		
For models:	120, 160, 240, 882, 885, 908, EN, ET, ETA, ETE20, ETE21, ETE25, ETE27, LPE100, LPE145		

			
1			
Part No.	512408	Ref. No.	00082549
description	wash arm L 625mm nozzles 4 mounting ø 41mm mounting pos. upper/lower with pin for pre-washing ELFRAMO		
For models:	EN, ET, ET020		

			
1			
Part No.	517501	Ref. No.	00079102
description	wash jet mounting pos. upper/lower H 18mm ø 24.4mm		
For models:	EN, ET, ET020, ETE20, ETE21, ETE25, ETE27, ETS15		

			
1			
Part No.	511077	Ref. No.	00004931
description	wash jet		

			
1			
Part No.	511640	Ref. No.	00011839
description	wash jet holder ø 40mm thread M32x2.5		

			
1			
Part No.	511715	Ref. No.	00222104
description	opposite support mounting pos. lower for wash arm support		
For models:	BD13, BD14, BD14alt, BD22, BD46, BD47, BE40		

			
1			
Part No.	511719	Ref. No.	00012710
description	opposite support mounting pos. lower for wash arm support		
For models:	B11, B15, BD11, BD50, BE35, BE50, BE50T, C33, CW650-15, CW650-16, CW650-35, CW650-36, D120, D30, D35, D36, D40, D40ELT, D40ELT-BTBA, D40i, D40i-BT-BA, D40i-ELT-BT-BA, D45, D80, D80F, D85		

			
1			
Part No.	511785	Ref. No.	00202781
description	opposite support mounting pos. lower for wash arm support		
For models:	42, 42E, 48, 48E, 55, 55E, 60		

			
1			
Part No.	511461	Ref. No.	00004260 old version
description	wash arm support		





			
1			
Part No.	511717	Ref. No.	00222101
description	wash arm support		
For models:	BD14, BD14alt, BD47		

			
1			
Part No.	511740	Ref. No.	00018063
description	wash arm support mounting pos. lower		
For models:	C34, C34dgt, C44, C44dgt, C44dgt-elt, C66, C66dgt, C66dgt-elt, C77, CE24, D120, D120dgt		

			
1			
Part No.	511735	Ref. No.	00014040
description	wash arm support		
For models:	D30, D35, D40, D40ELT, D40ELT-BT-BA, D40i, D40i-BT-BA, D40i-ELTBT-BA		

			
1			
Part No.	511710	Ref. No.	00011851
description	wash arm support mounting pos. upper		
For models:	BD13, BD14, BD14alt, BD22, BD46, BD47, BD50, BE40, BE50, BE50T, C33, CW650-15, CW650-16, CW650-35, CW650-36, D30, D35, D36, D40, D40ELT, D40ELT-BT-BA, D40i, D40i-BT-BA, D40i-ELT-BT-BA, D45, D80, D80F, D85		

			
1			
Part No.	511736	Ref. No.	00014055
description	wash arm support		
For models:	BD50, BE50, BE50T, D36, D45, D80		

			
1			
Part No.	511738	Ref. No.	00018062
description	wash arm support mounting pos. upper		
For models:	C34, C34dgt, C44, C44dgt, C44dgt-elt, C66, C66dgt, C66dgt-elt, C77, D120, D120dgt		

			
1			
Part No.	511036	Ref. No.	00004260 00011152
description	wash arm support mounting pos. lower		
For models:	882, 885, SQ885, SQT80		

			
1			
Part No.	511784	Ref. No.	00014020 00014021
description	wash arm support mounting pos. upper		
For models:	60		

			
1			
Part No.	511038	Ref. No.	00011195
description	wash arm support mounting pos. lower		
For models:	120, 160, 240, 906, 908		

			
1			
Part No.	511037	Ref. No.	00011194
description	wash arm support mounting pos. upper thread 1½"		
For models:	240, 906, 908		

			
1			
Part No.	511721	Ref. No.	00211014
description	wash arm support mounting pos. lower		
For models:	B11, B15, BD11, BD13, BD14, BD22, BD46, BE35, BE40		

			
1			
Part No.	511035	Ref. No.	00004270
description	wash arm support thread 1¼" mounting pos. upper		



rinse arm shafts



1

Part No.	511032	Ref. No.	00005000
description	rinse arm shaft		



1

Part No.	511039	Ref. No.	00011166
description	rinse arm shaft		
For models:	120, 160, 240, 42, 42E, 48, 48E, 55, 55E, 60, 906, 908		

knobs

producer-specific knobs

ELFRAMO



1

Part No.	112684	Ref. No.	00038683
description	knob gas thermostat 1-8 ø 55.5mm shaft ø 6x4.6mm shaft flat upper black		
For models:	GSDT12, GSDT20, GST12, GST20, GVM35T, GWDT12, GWDT20, GWT12, GWT20		



1

Part No.	110878	Ref. No.	00035809 00035813
description	knob gas thermostat 1-8 t.max. °C ø 52mm shaft ømm shaft flat Minisit black shaft special		
For models:	GM2532, GM2542, GMD2532, GMD2542, GW12, GW20, GWD12, GWD20		



1

Part No.	111220	Ref. No.	00033270
description	knob switch zero mark		



1

Part No.	110056	Ref. No.	00006500
description	knob switch zero mark ø 55mm shaft ø 5x5mm shaft flat horizontal black		
For models:	EB12, EB12+12, EB18P, EB6, EB6+6, EB8, EM12, EM12+12, EM20, EM20+20, EM20+20-900, EM20-900, EM35, EM40-900, ES12, ES20, ESD12, ESD20, FE12, FE20, FE20+20, FE30, FE30+30, KES20, KESD20, ST12, ST12+12, ST7, ST7+7		



1

Part No.	110005	Ref. No.	00033241
description	knob switch zero mark ø 55mm shaft ø 6x4.6mm shaft flat upper black		
For models:	EB6, EB6+6		



1

Part No.	110006	Ref. No.	00033250
description	knob switch zero mark ø 55mm shaft ø 6x4.6mm shaft flat upper black		
For models:	EB12, EB12+12, EB18P, EB6, EB6+6, EB8, EM12, EM12+12, EM20, EM20+20, EM20+20-900, EM20-900, EM35, EM40-900, ES12, ES20, ESD12, ESD20, FE12, FE20, FE20+20, FE30, FE30+30, GSDT12, GSDT20, GST12, GST20, GVM35T, GW209T, GWD209T, GWDT12, GWDT20, GWT12, GWT20, KES20, KESD20, ST12, ST12+12, ST7, ST7+7		



1

Part No.	110055	Ref. No.	00006520
description	knob switch zero mark ø 60mm shaft ø 5x5mm black		
For models:	LPE100, LPE145		



handles and hand wheels

bracket handles

1 			
Part No.	511100	Ref. No.	00001510 00009200
description	pull handle		

1 			
Part No.	511115	Ref. No.	00001530 00009220
description	pull handle L 445mm H 62mm mounting distance 425mm		

recessed handles



1 			
Part No.	511889	Ref. No.	00205530
description	recessed handle		
For models:	42, 42E, 48, 48E, 55, 55E, 60, B11, B15, BD11, BD13, BD14, BD14alt, BD46, BD47, BE35, BE40, EM12, EM12+12, EM20, EM20+20		

1 			
Part No.	511890	Ref. No.	00010610
description	recessed handle		
For models:	120, 160, 240, 882, 885, BD22, BD50, BE50, BE50T, D120, D120dgt, D30, D35, D36, D40, D40ELT, D40ELT-BT-BA, D40i, D40i-BT-BA, D40i-ELT-BT-BA, D45, D80, D80F, D85		

fittings for catering equipment

outlet taps

universal

1 			
Part No.	541609	Ref. No.	00030401
description	outlet tap chrome-plated brass W 46mm H 40mm thread 1" IT		
For models:	EB12, EB12+12, EB6, EB6+6, EB8, FG12M, FG24M, GB10, GBD10		
spare parts for	541609		
	Part No.	540747	Ref. No. —
	outlet tap chrome-plated brass angled W 30mm H 40mm thread 1/2" IT		

drain taps

brass

drain taps

1 			
Part No.	540260	Ref. No.	00030400
description	drain tap		
For models:	EB12, EB12+12, EB18P, EB6, EB6+6, EB8		

equipment feet and end caps

screw-in feet

1 			
Part No.	695604	Ref. No.	00000970 00000980 00013783
description	equipment foot thread M10 thread L 32mm ø 50mm H 14mm		
For models:	882, 885, BD14, BD14alt, BD22, BD46, BD47, C33, C44, C66, D30, D35, D36, D40, D40ELT, D40ELT-BT-BA, D40i, D40i-BT-BA, D40i-ELT-BT-BA, D45, D80, EB12, EB12+12, EB18P, EB6, EB6+6, EB8, EM12, EM12+12, EM20, EM20+20, EM20+20-900, EM20-900, EM35, EM40-900, ET, ET020, ETA, ETE20, ETE21, ETE25, ETE27, ETS15, GM12, GM12+12, GM20+20, GM20+20-900, GM25+25-900, GM25-900, GM35...(Other models you can see in the webshop)		

1 			
Part No.	695601	Ref. No.	00206960
description	equipment foot thread M17 thread L 23mm ø 24mm H 11mm plastic WS 24 Qty 1 pcs		
For models:	42, 42E, 48, 48E, 55, 55E, 60, B11, B15, BD11, BD13, BD50, BE35, BE40, BE50, BE50T, EB12, EB12+12, EB6, EB6+6, EB8		



baskets

fryer baskets

ELFRAMO



1

Part No.	970190	Ref. No.	00030560
description	fryer basket L1 265mm W1 180mm H1 120mm L2 480mm H2 215mm chrome-plated steel		
For models:	EB6, EB6+6, EM12		



1

Part No.	970193	Ref. No.	00030581 00030581neu,o.Griffe
description	fryer basket L1 288mm W1 107mm H1 120mm		
For models:	EB12, EB12+12, EM12, EM12+12, GM12+12		



1

Part No.	970277	Ref. No.	00035842
description	fryer basket L1 290mm W1 105mm H1 120mm L2 230mm H2 235mm chrome-plated steel		



1

Part No.	970191	Ref. No.	00030570 00030570 o.Griffe
description	fryer basket L1 290mm W1 180mm H1 120mm L2 520mm H3 230mm chrome-plated steel		
For models:	EB12, EB8		



1

Part No.	970278	Ref. No.	00035805
description	fryer basket L1 290mm W1 215mm H1 120mm L2 410mm H3 240mm chrome-plated steel		
For models:	ES12, ESD12, FG125, FG12M, FG24M, GB10, GBD10, GM2532, GMD2532, GST12, GW12, GW12ELT, GWD12, GWD12ELT, GWDT12, GWT12		



1

Part No.	970192	Ref. No.	00030580 00030580 no Man.Cest
description	fryer basket L1 290mm W1 235mm H1 120mm chrome-plated steel		
For models:	EB12, EB12+12, EB8, EM12, EM12+12, EM20, EM20+20, FE12, GM12+12		



1

Part No.	970286	Ref. No.	00030611
description	fryer basket L1 365mm W1 265mm H1 120mm chrome-plated steel		
For models:	EM35, GM35, GVM35, GVM35T		



1

Part No.	970284	Ref. No.	00003059 00030590
description	fryer basket L1 370mm W1 240mm H1 120mm L2 230mm H2 232mm H3 232mm chrome-plated steel		
For models:	EM12, EM12+12, EM20, EM20+20, FE20, FE20+20, FE30, FE30+30, GM20+20		



1

Part No.	970279	Ref. No.	00030591 00035843 3059A
description	fryer basket L1 375mm W1 105mm H1 120mm chrome-plated steel		
For models:	EM20, EM20+20, ES20, ESD20, FE20, FE20+20, FE30, FE30+30, FG157, FG159, FG307, FG309, GM20+20, GM2542, GMD2542, GST20, GW20, GW209T, GW20ELT, GWD20, GWD209T, GWD20ELT, GWDT20, GW-MODULARI, GWT20, KES20, KESD20		



1

Part No.	970281	Ref. No.	00035806
description	fryer basket L1 375mm W1 215mm H1 120mm chrome-plated steel		
For models:	ES20, ESD20, FG157, FG159, FG307, FG309, GM2532, GM2542, GMD2542, GST20, GW20, GW209T, GW20ELT, GWD20, GWD209T, GWD20ELT, GWDT20, GW-MODULARI, GWT20, KES20, KESD20		



 <p>1</p>			
Part No.	970590	Ref. No.	00030610
description	fryer basket L1 540mm W1 365mm H1 120mm chrome-plated steel		
For models:	EM35, GM35, GVM35, GVM35T		

 <p>1</p>			
Part No.	970591	Ref. No.	BFR0005
description	fryer basket L1 620mm W1 360mm H1 65mm		

warewashing baskets

steel wire baskets round

mix baskets

 <p>1</p>			
Part No.	970514	Ref. No.	00206731
description	mix basket ED ø 330mm H 145mm		
For models:	42, 42E, 48, 48E, 55, 55E, B11, BD11, BE35		

 <p>1</p>			
Part No.	970515	Ref. No.	00007400
description	mix basket ED ø 440mm H 145mm seat ø 445mm		
For models:	120, 160, 240, 42, 42E, 48, 48E, 55, 55E, 882, 885, 904, 906, 908, 912, BD22, SQ885, SQT80		

 <p>1</p>			
Part No.	970516	Ref. No.	00007420
description	mix basket ED ø 500mm H 125mm seat ø 445mm		
For models:	120, 160, 240, 882, 885, 904, 906, 908, 912		

<h3>plate baskets</h3>  <p>1</p>			
Part No.	970513	Ref. No.	00007320
description	plate basket ED ø 495mm H 120mm seat ø 445mm plates 18		
For models:	120, 160, 240, 882, 885, 904, 906, 908, 912		

steel wire baskets square

glass basket

 <p>1</p>			
Part No.	971052	Ref. No.	00206720
description	glass basket L 470mm W 470mm H 150mm number of rows 3 rows spacing 145mm		
For models:	42, 42E, 48, 48E, 55, 55E, 60, BD22		



mix baskets

 <p>1</p>			
Part No.	970078 ¹	Ref. No.	00007100
description	mix basket		
For models:	120, 160, 240, 882, 885, 904, 906, 908, 912		

¹wide-meshed

 <p>1</p>			
Part No.	971006 ¹	Ref. No.	00206711
description	mix basket L 345mm W 345mm H 120mm mesh type wide-meshed		
For models:	42, 42E, 48, 48E, 55, 55E, B11, BD11		

¹wide-meshed

 <p>1</p>				
Part No.	970068 ¹	Ref. No.	00206712	
description	mix basket L 400mm W 400mm H 170mm			
For models:	42, 42E, 48, 48E, 55, 55E, B15, BD13, BD14, BD46, BD47			
spare parts for	970068			
	Part No.	970001	Ref. No.	—
	 sliding corner wire gauge ø 5mm L 120mm W 120mm H 12mm L-shape			

¹wide-meshed



Part No.	971049 ¹	Ref. No.	00206713 X098E006/710
description	mix basket L 460mm W 460mm		
For models:	42, 42E, 48, 48E, 55, 55E, 60, BD22		

¹wide-meshed

Part No.	970074 ¹	Ref. No.	00007120
description	mix basket L 500mm W 500mm H 130mm mesh type close-meshed		
For models:	120, 160, 240, 882, 885, 904, 906, 908, 912, BD50, BE50, BE50T, C33, C34, C34dgt, C44, C44dgt, C44dgt-elt, C66, C66dgt, C66dgt-elt, CE24, D30, D35, D36, D40, D40ELT, D40ELT-BT-BA, D40i, D40i-BT-BA, D40i-ELT-BT-BA, D45, D80, D85, SQ885, SQT80		

¹fine-meshed

Part No.	970027 ¹	Ref. No.	00007140
description	mix basket L 550mm W 550mm H 125mm mesh type close-meshed		
For models:	120, 160, 240, 882, 885, 904, 906, 908, 912, C77, D120, D120dgt		

¹fine-meshed

plate baskets



Part No.	971051	Ref. No.	00007000
description	plate basket L 470mm W 470mm H 100mm plates 16 plate ø 240mm		
For models:	120, 160, 240, 42, 42E, 48, 48E, 55, 55E, 60, 882, 885, 904, 906, 908, 912, BD22		



Part No.	971043	Ref. No.	00007020 00007040
description	plate basket L 500mm W 500mm H 130mm plates 20 plate ø 240mm		
For models:	120, 160, 240, 882, 885, 904, 906, 908, 912, BD50, BE50, BE50T, C33, C34, C34dgt, C44, C44dgt, C44dgt-elt, C66, C66dgt, C66dgt-elt, CE24, D30, D35, D36, D40, D40ELT, D40ELT-BT-BA, D40i, D40i-BT-BA, D40i-ELT-BT-BA, D45, D80, D85, SQ885, SQT80		



Part No.	970026	Ref. No.	00007060 X098E012/706
description	plate basket L 550mm W 550mm H 130mm plates 24 plate ø 270mm		
For models:	120, 160, 240, 882, 885, 904, 906, 908, 912, C77, D120, D120dgt		

plastic baskets square

mix baskets



Part No.	971058	Ref. No.	00206701
description	mix basket L 350mm W 350mm H 150mm		
For models:	BE35		

system baskets GIADOS 500x500mm

universal baskets



Part No.	976030	Ref. No.	FAA028
description	tray rack L 500mm W 500mm H 116mm tablets 9		
For models:	160, 882, 885		

accessories

cutlery inserts



Part No.	976016	Ref. No.	00206721
description	cutlery insert L 110mm W 110mm ømm H 130mm		



Part No.	976011	Ref. No.	00206721
description	cutlery insert Lmm Wmm ø 110mm H 130mm		



plate inserts



1

Part No.	970047	Ref. No.	00007200 00206751 00206752
description	plate insert L 308mm W 100mm plates 15		
For models:	120, 160, 240, 42, 42E, 48, 48E, 55, 55E, 60, 882, 885, 904, 906, 908, 912, B11, B15, BD11, BD13, BD14, BD22, BD46, BD47, BD50, BE35, BE40, BE50, BE50T, C33, C34, C34dgt, C44, C44dgt, C44dgt-elt, C66, C66dgt, C66dgt-elt, C77, CE24, D120, D120dgt, D30, D35, D36, D40, D40ELT, D40ELT-BT-BA, D40i, D40i-BT-BA...(Other models you can see in the webshop)		

gaskets

O-rings

EPDM

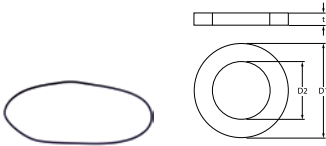

1

Part No.	521717	Ref. No.	00000290 00002900 06140008 06140140
description	O-ring EPDM thickness 1.78mm ID ø 120.37mm Qty 1 pcs		
For models:	42, 42E, 48, 48E, 55, 55E, 60, 882, 885, BD22, C33, C34, C34dgt, D30, D35, D36, D40, D40ELT, D40ELT-BT-BA, D40i, D40i-BT-BA, D40i-ELT-BTBA, D45, D80, D80F, D85, SQ885, SQT80		



1

Part No.	529412	Ref. No.	06140003
description	O-ring EPDM thickness 2.62mm ID ø 10.78mm Qty 1 pcs		

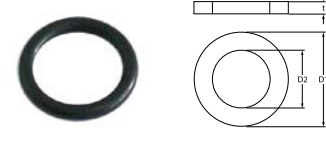

1

Part No.	507313	Ref. No.	06140002
description	O-ring EPDM thickness 2.62mm ID ø 13.95mm Qty 1 pcs		
For models:	BD14, BD14alt, C33, D30, D40, D80		

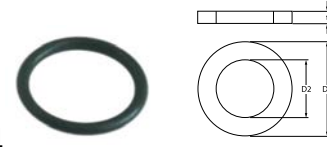

1

Part No.	528919	Ref. No.	00004480 06140005
description	O-ring EPDM thickness 2.62mm ID ø 20.24mm Qty 1 pcs		
For models:	42, 42E, 48, 48E, 55, 55E, 60, 882, 885, B11, BD11, BE35, SQ885, SQT80		

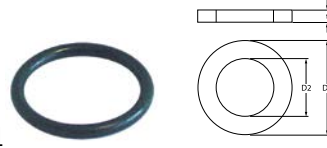

1

Part No.	505073	Ref. No.	06140005
description	O-ring EPDM thickness 2.62mm ID ø 20.63mm Qty 1 pcs		

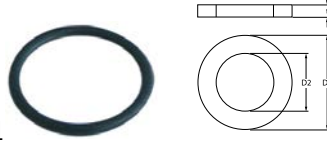

1

Part No.	510769	Ref. No.	06140004
description	O-ring EPDM thickness 2.62mm ID ø 25.07mm Qty 1 pcs		
For models:	B11, B15, BD13, BD14, BD14alt, BD46, BD47, BE35, C44, C44dgt, C44dgt-elt, C66, C66dgt, C66dgt-elt, C77, D40, D40ELT, D40ELT-BT-BA, D40i-ELT-BT-BA, D45		

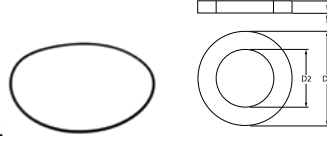

1

Part No.	521718	Ref. No.	00002910 06140010
description	O-ring EPDM thickness 3.53mm ID ø 164.7mm Qty 1 pcs		
For models:	120, 160, 906, 908, C44, C44dgt, C44dgt-elt, C66, C66dgt, C66dgt-elt, C77, D120, D120dgt, EN, ET, ET020, ETA, ETE20, ETE21, ETE25, ETE27, ETS15		

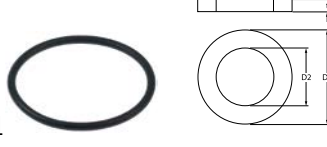

1

Part No.	532451	Ref. No.	06140028
description	O-ring EPDM thickness 3.53mm ID ø 53.98mm Qty 1 pcs		
For models:	ETE20, ETE21, ETE25, ETE27, ETS15		



			
Part No.	511828	Ref. No.	06140018
description	O-ring EPDM thickness 3.53mm ID ø 56.74mm Qty 1 pcs		
For models:	B11, B15, BD11, BD13, BD14, BD14alt, BD22, BD46, BD47, BD50, BE35, BE40, BE50, BE50T, C33, C34, C34dgt, C44, C44dgt, C44dgt-elt, C66, C66dgt, C66dgt-elt, C77, CE24, CW650-15, CW650-16, CW650-35, CW650-36, D120, D120dgt, D30, D35, D36, D40, D40ELT, D40ELT-BTBA, D40i, D40i-BT-BA, D40i-ELT-BT-BA, D45, D80, D80F, D85, ETE20, ETE21, ETE25, ETE27, ETS15, LP60...(Other models you can see in the webshop)		

			
Part No.	511711	Ref. No.	06140026
description	O-ring EPDM thickness 3.53mm ID ø 78.97mm Qty 1 pcs		
For models:	B11, B15, BD11, BD13, BD14, BD14alt, BD22, BD46, BD47, BD50, BE35, BE40, BE50, BE50T, C33, C34, C34dgt, C44, C44dgt, C44dgt-elt, C66, C66dgt, C66dgt-elt, C77, CW650-15, CW650-16, CW650-35, CW650-36, D120, D120dgt, D30, D35, D36, D40, D40ELT, D40ELT-BT-BA, D40i, D40i-BT-BA, D40i-ELT-BT-BA, D45, D80, D80F, D85		

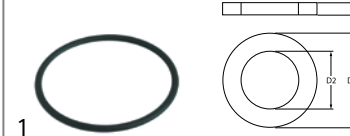
			
Part No.	505178	Ref. No.	06140035
description	O-ring EPDM thickness 5.34mm ID ø 85.09mm Qty 1 pcs		
For models:	ETE20, ETE21, ETE25, ETE27, ETS15		

			
Part No.	521154	Ref. No.	06140046
description	O-ring ID ø 152.7mm thickness 2.62mm EPDM Qty 1 pcs		
For models:	C66dgt		

sealing washers

fibre gaskets

			
Part No.	506042	Ref. No.	06110006 06120004
description	flat gasket FIBER ED ø 27mm ID ø 17mm thickness 2mm Qty 1 pcs		
For models:	C34dgt, C44, C44dgt, C66, C66dgt, C77, CE24, D120, D120dgt, LP130		

			
Part No.	511490	Ref. No.	06120001
description	flat gasket fibre ED ø 15mm ID ø 8mm thickness 2mm Qty 1 pcs		
For models:	B11, B15, BD11, BD13, BD14, BD14alt, BD22, BD47, BE35, BE40, BE50, C33, C34, C34dgt, C44, C44dgt, C44dgt-elt, C66, C66dgt, C66dgt-elt, C77, CE24, CW650-15, CW650-16, CW650-35, CW650-36, D120, D30, D40, D40ELT, D40ELT-BT-BA, D40i-BT-BA, D40i-ELT-BT-BA, D80, D80F, D85, LP130		

plastic gaskets

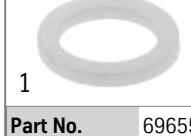
			
Part No.	696557	Ref. No.	06113001
description	flat gasket polyoxymethylene ED ø 14mm ID ø 10mm thickness 1.5mm Qty 1 pcs		
For models:	BD46, BD47, BD50, BE50, BE50T, C44dgt, C44dgt-elt, C66dgt, C66dgt-elt, D120, D120dgt, D35, D36, D40i, D40i-BT-BA, D40i-ELT-BT-BA, D45, D80, D85		

			
Part No.	696375	Ref. No.	00010504
description	gasket plastic ED ø 19mm ID ø 10.5mm thickness 6mm for boiler Qty 1 pcs		
For models:	B11, BD11, BD13, BD14, BD14alt, BD22, BD46, BD47, BD50, BE35, BE40, BE50, BE50T, C33, C34, C34dgt, C44, C44dgt, C44dgt-elt, C66, C66dgt, C66dgt-elt, C77, CE24, D120, D120dgt, D30, D35, D36, D40, D40ELT, D40ELT-BT-BA, D40i, D40i-ELT-BT-BA, D45, D80, D80F, D85, GFP25, GFP25AC, GFU25, GFU25AC, LP130, LP61, LP61H, LP70		

copper gaskets

DIN-7603-A

			
Part No.	560523	Ref. No.	02150006
description	flat gasket nickel-plated copper ED ø 18.5mm ID ø 12.2mm thickness 2mm Qty 1 pcs		
For models:	BD46, BD47, BD50, BE40, BE50, C33, C34, C34dgt, C44, C66, C77, D120, D35, D36, D40i, D40i-BT-BA, D40i-ELT-BT-BA, D45, D80, D85		

PTFE gaskets

			
Part No.	511589	Ref. No.	06112001
description	flat gasket PTFE ED ø 11mm ID ø 4.5mm thickness 2mm Qty 1 pcs		
For models:	BD13, BD14, BD46, BD47, BD50, BE35, BE40, BE50, C33, C34, C34dgt, C44, C44dgt, C44dgt-elt, C66, C66dgt, C66dgt-elt, C77, D120, D120dgt, D35, D36, D40, D40i, D40i-ELT-BT-BA, D45, D80, D85, GFP25, GFP25AC, GFU25, GFU25AC		



shaft gaskets

v-rings



1			
Part No.	511213	Ref. No.	00530523
description	V-ring		
For models:	Cybergel, EM240, EM360, EM480, EM612, EM-HT		

special gaskets

miscellaneous



1			
Part No.	511106	Ref. No.	00000147 00001470
description	window gasket		

springs

compression springs



1			
Part No.	511117	Ref. No.	0000235A 00073718
description	compression spring ø 14.2/8.1mm L 53mm wire gauge ø 1.2mm cone-shaped		

roller springs

roller springs



1			
Part No.	511116	Ref. No.	00002301 0000230A
description	roller spring mounting pos. left complete		
spare parts for	511116		
	Part No.	511622	Ref. No. 00002310
	roller spring mounting pos. right/left W 40mm		

1			
Part No.	511127	Ref. No.	00002300
description	roller spring mounting pos. right complete		
spare parts for	511127		
	Part No.	511622	Ref. No. 00002310
	roller spring mounting pos. right/left W 40mm		

1			
Part No.	511622	Ref. No.	00002310
description	roller spring mounting pos. right/left W 40mm		

1			
Part No.	519550	Ref. No.	00079740
description	roller spring W 25.35mm		
For models:	ETE20, ETE21, ETE25, ETE27		

1			
Part No.	519491	Ref. No.	00079730
description	roller spring W 26mm		
For models:	ETE20, ETE21, ETE25, ETE27, ETS15, LP130, LP60H, LP61H, LP70		

1			
Part No.	519543	Ref. No.	00065816
description	roller spring with holder W 46mm ID ømm lug lengthmm		
For models:	LP130, LP60, LP60H, LP61, LP61H		



tension springs



Part No.	361593	Ref. No.	00000812
description	spring		



Part No.	511875	Ref. No.	00013717 00013719
description	tension spring		
For models:	BD14, BD14alt, BD22, D40, D40ELT, D40ELT-BT-BA, D40i, D40i-BT-BA, D40i-ELT-BT-BA, D80, D80F		



Part No.	511904	Ref. No.	00013717
description	tension spring ø 15.1mm total length 148mm wire gauge ø 1.7mm		
For models:	BD14, BD46, BD47, D36, D40, D40i, D40i-ELT-BT-BA, D45, D80, D85, ET, ETE20, ETE21, ETE25, ETE27, ETS15		



Part No.	511216	Ref. No.	00018056
description	tension spring ø 25mm total length 790mm wire gauge ø 5mm L1 120mm L2 580mm D1 ø 23mm thread M8 thread L 90mm mounting pos. left/right for hood		
For models:	C34, C34dgt, C44, C44dgt, C44dgt-elt, C66, C66dgt, C66dgt-elt, C77, CE24		

dosing pumps

peristaltic dosing pumps

SEKO

built-in version

with frequency control



Part No.	362025	Ref. No.	20155111
description	dosing pump SEKO frequency control 0.3-3.0l/h 230VAC detergent hose ø 4x6mm hose Santoprene type NBR 3 with accessories angled 90°		
For models:	B11, BD11, BD13, BD14, BD22, BD46, BD47, BD50, BE35, BE40, BE50, BE50T, C33, C34, C34dgt, C44, C44dgt, C44dgt-elt, C66, C66dgt, C66dgt-elt, C77, CW650-15, CW650-16, CW650-35, CW650-36, D120, D120dgt, D30, D35, D36, D40, D40ELT, D40ELT-BT-BA, D40i, D40i-ELTBT-BA, D45, D80, D80F, D85, EN, ET, ETS15, LP130, LP60, LP60H, LP61, LP61H, LP70		



Part No.	361215	Ref. No.	20155100 20155111 old version
description	dosing pump SEKO frequency control 0.3-3.0l/h 230VAC detergent hose ø 4x6mm hose type K hose Santoprene suction level 1.5m type PBR protection IP55 dimensions 100x67x68mm power input 3.5W		
For models:	42, 42E, 48, 48E, 55, 55E, 60, B11, B15, BD11, BD13, BD14, BD14alt, BD22, C33, C44, C66, D120, D30, D40, D80, D80F, LP130, LP60, LP70		
spare parts for	361215		
	Part No.	361136	Ref. No. —
	roller assembly for dosing pump hole ø 4.8x4mm		
	Part No.	361226	Ref. No. —
	PCB L 59mm W 26mm electronic control		
	Part No.	361815	Ref. No. 20155112
	pump hose detergent hose ø 6x10mm hose ø 4x6mm hose type K hose Santoprene type SEKO		
accessories for	361215		
	Part No.	361142	Ref. No. —
	mounting set detergent hose type 4x6mm hose length 2m PVC 2x hose/container filter/tank intake transparent		
	Part No.	520090	Ref. No. 07125002
	PVC hose ID ø 4mm ED ø 6mm L 2m thickness 1mm t.max. 60°C transparent		
	Part No.	520091	Ref. No. 20155110
	nylon hose ID ø 4mm ED ø 6mm L 2m thickness 1mm operating p. 10bar burst p. 50bar t.max. 100°C transparent		



with time control





Part No.	361768 ¹	Ref. No.	00220423 old version 20155104 old version
description	dosing pump SEKO time control 0.4l/h 230VAC rinse aid hose ø 4x6mm hose type D hose Sekobril suction level 1.5m type NBM 0.4 8W with accessories 8VA dosing time 0-30s		
spare parts for	361768		
	Part No.	361135	Ref. No. 20155109
	pump hose SEKO rinse aid hose ø 3x8mm hose ø 4x6mm hose type D hose Sekobril		
	Part No.	361141	Ref. No. 20155105
	container filter with weight ceramic hose ø 4mm		



¹with accessories Table continues overleaf



spare parts for 361768			
	Part No.	361821	Ref. No. 00220419
non-return valve inlet 4x6mm outlet 1/4" L 45mm			
	Part No.	520091	Ref. No. 20155110
nylon hose ID ø 4mm ED ø 6mm L 2m thickness 1mm operating p. 10bar burst p. 50bar t.max. 100°C transparent			
	Part No.	520242	Ref. No. —
silicone hose for peristaltic pump ID ø 4mm ED ø 7mm L 5m thickness 1.5mm t.max. 200°C Shore A 55° transparent dosing Qty 5m			







			
1			
Part No.	362024	Ref. No.	20155104 20155104 new version
description	dosing pump SEKO time control 0.4l/h 230VAC rinse aid hose ø 4x6mm hose type Sekobril type NBM 0.4 with accessories angled 90°		
For models:	B11, B15, BD11, BD13, BD14, BD14alt, BD22, BD46, BD47, C33, C44, C44dgt, C44dgt-elt, C66, C66dgt, C66dgt-elt, CW650-15, CW650-16, CW650-35, CW650-36, D120, D120dgt, D30, D36, D40, D40ELT, D45, D80, D80F, D85, LP130, LP60, LP60H, LP70		

spare parts			
			
			
1			
Part No.	361815	Ref. No.	20155112
description	pump hose detergent hose ø 6x10mm hose ø 4x6mm hose type K hose Santoprene type SEKO		
For models:	B11, BD11, BD13, BD14, BD22, BD46, BD47, BD50, BE35, BE40, BE50, C33, C34, C34dgt, C44, C44dgt, C66, C66dgt, C77, CW650-15, CW650-16, CW650-35, CW650-36, D120, D120dgt, D30, D35, D36, D40, D40ELT, D40ELT-BT-BA, D40i, D40i-ELT-BT-BA, D45, D80, D80F, D85, EN, ET, ETE20, ETE21, ETE25, ETE27, ETS15, LP130, LP60, LP60H, LP61, LP61H, LP70		

			
1			
Part No.	361135	Ref. No.	20155109
description	pump hose SEKO rinse aid hose ø 3x8mm hose ø 4x6mm hose type D hose Sekobril		
For models:	B11, BD11, BD13, BD14, BD22, BD46, BD47, C33, C34, C34dgt, C44, C44dgt, C66, C66dgt, CW650-15, CW650-16, CW650-35, CW650-36, D120, D120dgt, D30, D35, D36, D40, D40ELT, D45, D80, D80F, D85, EN, ET, ETE20, ETE21, ETE25, ETE27, ETS15, LP130, LP60, LP60H, LP70		
spare parts for 361135			
	Part No.	361866	Ref. No. —
union nut for hose connector ø 17mm			

membrane dosing pumps

self-priming			
LANG			
accessories			
			
1			
Part No.	361083	Ref. No.	00220413
description	union nut T1: M10x1 for hose 6mm		

SEKO			
			
1			
Part No.	361594	Ref. No.	20155108
description	dosing pump type DIB3E rinse aid pump rate 0-3cm³ per stroke pressure connection ø 4x6mm suction connection ø 4x6mm		
For models:	BD13, BD14, BD46, BD47, BD50, BE35, BE40, BE50, C33, C34, C34dgt, C44, C44dgt, C66, C66dgt, C77, D120, D30, D35, D36, D40, D40ELT, D40ELT-BT-BA, D40i, D40i-ELT-BT-BA, D45, D80, D85, LP130, LP60, LP60H, LP61, LP61H, LP70		
spare parts for 361594			
	Part No.	361240	Ref. No. —
hose connector 1-way hose ø 6mm plastic connection M10x1			
	Part No.	361301	Ref. No. —
hose connector for type DIB3E/DIB5E			
	Part No.	361302	Ref. No. —
valve bush for type DIB3E/DIB5E			
	Part No.	361304	Ref. No. —
O-ring EPDM ID ø 11.11mm thickness 1.78mm Qty 1 pcs for type DIB3E/DIB5E			
	Part No.	361305	Ref. No. —
valve disc for type DIB3E/DIB5E DIB3P/DIB5P			
	Part No.	361306	Ref. No. —
membrane for type DIB3E/DIB5E ø 49mm hole ø 5mm			
	Part No.	361481	Ref. No. —
lip valve for type DIB3P/DIB5P DIB3E/DIB5E			



Part No.	361837 ¹	Ref. No.	2015511+00019656 20155117
description	dosing pump type DIB5E conversion kit rinse aid pump rate 0-5cm ³ per stroke pressure connection ø 4x6mm suction connection ø 6mm SEKO		
For models:	BD46, BD47, BE35, BE40, BE50, BE50T, C34, C44dgt, C44dgt-elt, C66dgt, C66dgt-elt, CE24, D120dgt, D36, D45, LP61, LP61H		

spare parts for 361837

	Part No.	361301	Ref. No.	—
	hose connector for type DIB3E/DIB5E			

	Part No.	361302	Ref. No.	—
	valve bush for type DIB3E/DIB5E			

	Part No.	361304	Ref. No.	—
	O-ring EPDM ID ø 11.11mm thickness 1.78mm Qty 1 pcs for type DIB3E/DIB5E			

	Part No.	361305	Ref. No.	—
	valve disc for type DIB3E/DIB5E DIB3P/DIB5P			

	Part No.	361306	Ref. No.	—
	membrane for type DIB3E/DIB5E ø 49mm hole ø 5mm			

	Part No.	361307	Ref. No.	—
	membrane dosing pump ø 68mm hole ø 6mm for type DIB3P/DIB5P			

	Part No.	361481	Ref. No.	—
	lip valve for type DIB3P/DIB5P DIB3E/DIB5E			

accessories for 361837

	Part No.	361240	Ref. No.	—
	hose connector 1-way hose ø 6mm plastic connection M10x1			

	Part No.	361241	Ref. No.	—
	hose connector 1-way hose ø 9mm plastic connection M10x1			

¹auxiliary pressure connection closed

accessories



Part No.	361141	Ref. No.	20155105
description	container filter with weight ceramic hose ø 4mm		
For models:	B11, BD11, BD13, BD14, BD22, C33, C44, C66, CW650-15, CW650-16, CW650-35, CW650-36, D120, D30, D40, D40ELT, D80, D80F		

non-return valves

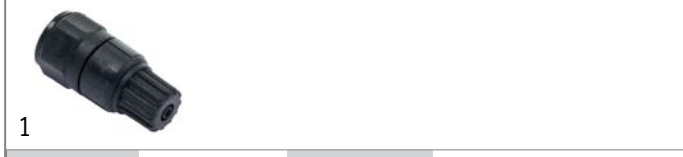

Part No.	361821	Ref. No.	00220419
description	non-return valve inlet 4x6mm outlet 1/4" L 45mm		
For models:	B11, BD13, BD22, BD46, BD47, C33, C34, C34dgt, C44, C44dgt, C44dgt-elt, C66, C66dgt, C66dgt-elt, C77, D120, D120dgt, D30, D35, D36, D40, D40ELT, D40ELT-BT-BA, D40i, D45, D80, D85, LP130, LP60, LP60H, LP61, LP61H, LP70		



Part No.	361147	Ref. No.	20155106
description	non-return valve inlet 4x6mm outlet 1/8" L 50mm Qty 1 pcs		
For models:	B11, BD11, BD13, BD14, BD22, C33, C44, C66, CW650-15, CW650-16, CW650-35, CW650-36, D120, D30, D40, D40ELT, D80, D80F, LP130, LP70		

hoses

dosing hoses



Part No.	511164	Ref. No.	00003780
description	dosing hose ED ø 10mm ID ø 6mm L 1800mm dosing		

PVC hoses



Part No.	520090	Ref. No.	07125002
description	PVC hose ID ø 4mm ED ø 6mm L 2m thickness 1mm t.max. 60°C transparent		
For models:	B11, B15, BD11, BD13, BD14, BD14alt, BD22, BD50, BE35, BE40, BE50, C33, C34, C34dgt, C44, C66, C77, CE24, CW650-15, CW650-16, CW650-35, CW650-36, D120, D30, D35, D40, D40ELT, D40ELT-BT-BA, D40i, D40i-ELT-BT-BA, D80, D80F, EN, ET, ET020, ETA, ETE20, ETE21, ETE25, ETE27, ETS15, LP130, LP60, LP60H, LP61, LP61H, LP70		

accessories for 520090

	Part No.	361058	Ref. No.	—
	container filter with non-return valve SS hose ø 4x6mm ø 20mm L 56mm			



	Part No.	361066	Ref. No.	—
	container filter straight SS hose ø 4x6mm L 37mm non return valve ball valve			

	Part No.	361106	Ref. No.	—
	container filter with weight and non-return valve SS hose ø 4x6mm ø 21mm L 51mm non return valve lip valve			

	Part No.	361141	Ref. No.	20155105
	container filter with weight ceramic hose ø 4mm			

Table continues overleaf



accessories for		520090	
	Part No.	361230	Ref. No. —
container filter with weight stainless steel hose ø 4x6mm			
	Part No.	361462	Ref. No. —
container filter with weight SS hose ø 4x6mm			
	Part No.	361728	Ref. No. —
container filter with 4m 4x6 hose SS hose ø 4x6mm hose length 4000mm			

hose couplings

plastic



1	Part No.	511593	Ref. No.	00220440
description hose connector T-shape plastic thread 1/2" ø 13mm for dosing pump				
spare parts for 511593				
	Part No.	361083	Ref. No.	00220413
union nut T1: M10x1 for hose 6mm				

tank inlets



1	Part No.	361416	Ref. No.	20155114
description tank inlet SS M12 hose ø 6mm				
For models: B11, BD13, BD14, BD46, BD47, BD50, BE35, BE40, BE50, BE50T, C33, C34, C34dgt, C44, C44dgt, C44dgt-elt, C66, C66dgt, C66dgt-elt, C77, D120, D120dgt, D30, D35, D36, D40, D40ELT, D40ELT-BT-BA, D40i, D40i-ELT-BT-BA, D45, D80, D85, EN, ET, ETE20, ETE21, ETE25, ETE27, ETS15, LP130, LP60, LP60H, LP61, LP61H, LP70				

hoses



supply hoses



stainless steel flexi hoses



universal hoses



1	Part No.	520627	Ref. No.	00053360
description flex hose SS braid straight-straight DN12 connections 3/4" L 2000mm approval DVGW operating p. 10bar test pressure 32bar burst p. 95bar				
For models: EN, ET, ETA				

1			
			
Part No.	520395	Ref. No.	00000354 00003540
description flex hose SS braid straight-straight DN8 connections 3/8"-1/2" L 230mm Qty 2 pcs			

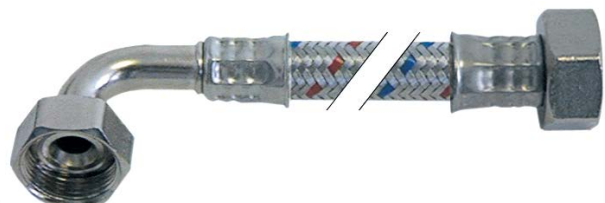
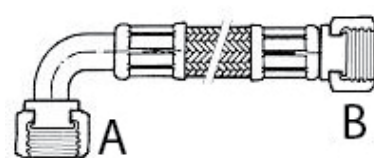
1			
			
Part No.	520459	Ref. No.	00003530
description flex hose SS braid straight-straight DN8 connections 3/8"-1/2" L 740mm approval DVGW operating p. 10bar test pressure 32bar burst p. 95bar			
For models: CW650-15, CW650-16, CW650-35, CW650-36, LP70			

1			
			
Part No.	520008	Ref. No.	00053060 00053090 00053100 00053120 00053130
description flex hose SS braid straight-curved DN12 connection 1: 3/4" connection 2: 3/4" L 1500mm approval DVGW operating p. 10bar test pressure 32bar burst p. 95bar			
accessories for 520008			
	Part No.	520054	Ref. No. —
flat gasket rubber ED ø 23.5mm ID ø 14mm thickness 2.3mm Qty 10 pcs			



1

Part No.	520007	Ref. No.	336A
description	flex hose SS braid straight-curved DN15 connection 1: 3/4" connection 2: 3/4" L 2500mm approval operating p. 10bar test pressure 32bar burst p. 95bar		

1

Part No.	520468	Ref. No.	12160008
description	flex hose SS braid straight-curved DN8 connection 1: 1/2" connection 2: 3/8" L 350mm approval DVGW operating p. 10bar test pressure 32bar burst p. 95bar		
For models:	BE35, BE40		

1

Part No.	520396	Ref. No.	00000355 00003550
description	flex hose SS straight-curved L 170mm connections 3/8"-1/2"		

PVC supply hoses

1

Part No.	520010	Ref. No.	00200720 07130001 07130002
description	supply hose PVC straight-curved DN13 connections 3/4" L 1500mm operating p. 10bar burst p. 32bar t.max. 90°C blue approval VDE flat seal		
For models:	120, 160, 240, 42, 42E, 48, 48E, 55, 55E, 60, 882, 885, 904, 906, 908, 912, B11, B15, BD11, BD13, BD14, BD14alt, BD22, BD46, BD47, BD50, BE35, BE40, BE50, BE50T, C33, C34, C34dgt, C44, C44dgt, C44dgt-elt, C66, C66dgt, C66dgt-elt, C77, CE24, D120, D120dgt, D30, D35, D36, D40, D40ELT, D40ELT-BT-BA, D40i... (Other models you can see in the webshop)		
accessories for	520010		
	Part No.	520053	Ref. No. —
	screen connection 3/4" D1 ø 26mm D2 ø 15mm Qty 10 pcs rubber thickness 8mm		
	Part No.	520054	Ref. No. —
	flat gasket rubber ED ø 23.5mm ID ø 14mm thickness 2.3mm Qty 10 pcs		

pre-rinse hoses

stainless steel flexi hoses

1

Part No.	542859	Ref. No.	00980050
description	shower hose connections 1/2" L 1200mm SS operating p. 10bar burst p. 90bar t.max. 90°C for pre-rinse units suitable for drinking water rotary with flexible fabric		
For models:	C33, C34, C34dgt, C44, C44dgt, C44dgt-elt, C66, C66dgt, C66dgt-elt, C77, ET, ETA		

drain hoses

1

Part No.	511206	Ref. No.	07130157
description	drain hose		
For models:	42, 42E, 48, 48E, 55, 55E, 60, B11, BD11, BD13, BD14, BD22, BD50, BE35, BE40, BE50, BE50T, D30, D35, D36, D40, D40ELT, D40ELT-BT-BA, D40i, D40i-ELT-BT-BA, D45, D80		



			
Part No.	513718	Ref. No.	00003630 00003640 00200652 00200653
description	drain hose DN19 L 1500mm straight ø inside 24mm straight ext. ø 28mm outer hose ø 23mm		

			
Part No.	511205	Ref. No.	00000364 07130156
description	drain hose DN19 L 1500mm A int. ø 23mm A ext. ø 29mm B int. ø 29mm outer hose ø 29mm B ext. ø 35mm		

			
Part No.	530608	Ref. No.	00003630 00003640 00200652 00200653 07130155 07130156
description	drain hose DN24 L 1500mm A int. ø 24mm A ext. ø 28mm B int. ø 28mm B ext. ø 35mm outer hose ø 29mm temp.-resist. 90°C		
For models:	120, 160, 240, 42, 42E, 48, 48E, 55, 55E, 60, 882, 885, 906, 908, B11, B15, BD11, BD13, BD14, BD14alt, BD22, BD46, BD47, BD50, BE35, BE40, BE50, BE50T, C33, C34, C34dgt, C44, C44dgt, C44dgt-elt, C66, C66dgt, C66dgt-elt, C77, D120, D120dgt, D30, D35, D36, D40, D40ELT, D40ELT-BT-BA, D40i, D40i-BT-BA, D40i-ELT-BT-BA, D45...(Other models you can see in the webshop)		

			
Part No.	530399	Ref. No.	07130158
description	drain hose DN31 L 2000mm A int. ø 33mm A ext. ø 39mm B int. ø 33mm B ext. ø 39mm outer hose ø 35mm		
For models:	C33, C34, C34dgt, C44, C44dgt, C44dgt-elt, C66, C66dgt, C66dgt-elt, C77, CE24, CW650-15, CW650-16, CW650-35, CW650-36, D120, D120dgt, D30, D40, D80, D80F, D85, LP60, LP60H, LP61, LP61H		







industrial hoses

nylon hoses

			
Part No.	520091	Ref. No.	20155110
description	nylon hose ID ø 4mm ED ø 6mm L 2m thickness 1mm operating p. 10bar burst p. 50bar t.max. 100°C transparent		
For models:	B11, BD11, BD13, BD14, BD22, C33, C44, C66, CW650-15, CW650-16, CW650-35, CW650-36, D120, D30, D40, D40ELT, D80, D80F		

PVC hoses

PVC hoses without fabric

			
Part No.	520090	Ref. No.	07125002
description	PVC hose ID ø 4mm ED ø 6mm L 2m thickness 1mm t.max. 60°C transparent		
For models:	B11, B15, BD11, BD13, BD14, BD14alt, BD22, BD50, BE35, BE40, BE50, C33, C34, C34dgt, C44, C66, C77, CE24, CW650-15, CW650-16, CW650-35, CW650-36, D120, D30, D35, D40, D40ELT, D40ELT-BT-BA, D40i, D40i-ELT-BT-BA, D80, D80F, EN, ET, ET020, ETA, ETE20, ETE21, ETE25, ETE27, ETS15, LP130, LP60, LP60H, LP61, LP61H, LP70		
accessories for	520090		
	Part No.	361058	Ref. No. —
	container filter with non-return valve SS hose ø 4x6mm ø 20mm L 56mm		
	Part No.	361066	Ref. No. —
	container filter straight SS hose ø 4x6mm L 37mm non return valve ball valve		
	Part No.	361106	Ref. No. —
	container filter with weight and non-return valve SS hose ø 4x6mm ø 21mm L 51mm non return valve lip valve		
	Part No.	361141	Ref. No. 20155105
	container filter with weight ceramic hose ø 4mm		
	Part No.	361230	Ref. No. —
	container filter with weight stainless steel hose ø 4x6mm		
	Part No.	361462	Ref. No. —
	container filter with weight SS hose ø 4x6mm		
	Part No.	361728	Ref. No. —
	container filter with 4m 4x6 hose SS hose ø 4x6mm hose length 4000mm		



silicone hoses

without fabric



Part No.	530410	Ref. No.	00003750 00011065
description	silicone hose ID ø 4mm ED ø 7mm L 2m thickness 1.5mm t.max. 200°C transparent		
For models:	120, 160, 240, 42, 42E, 48, 48E, 55, 55E, 60, 882, 885, 904, 906, 908, 912, B11, BD11, BD13, BD14, BD22, BD46, BD47, BD50, BE35, BE40, BE50, BE50T, C33, C34, C34dgt, C44, C44dgt, C44dgt-elt, C66, C66dgt, C66dgt-elt, C77, D120, D120dgt, D30, D35, D36, D40, D40ELT, D40ELTBT-BA, D40i, D40i-BT-BA, D45, D80...(Other models you can see in the webshop)		

formed hoses

straight



Part No.	511048	Ref. No.	00004060 00072970 00200671 00200676 00200678
description	formed hose dishwasher straight equiv. no. 00004060		
For models:	120, 160, 42, 42E, 48, 48E, 55, 55E, 906, 908, C34, C44, C44dgt, C44dgt-elt, C66, C66dgt, C66dgt-elt, C77, CE24, D120, D120dgt, EN, ET, ET020, ETA, ETE20, ETE21, ETE25, ETE27		



Part No.	511858	Ref. No.	00013827 00222217
description	formed hose dishwasher straight equiv. no. 00013827		
For models:	BD22, C33, CW650-15, CW650-16, CW650-35, CW650-36, D30, D35, D36, D40, D40ELT, D40ELT-BT-BA, D40i, D40i-BT-BA, D40i-ELT-BT-BA, D45, D80, D80F, D85		

form L



Part No.	511050	Ref. No.	00004070 00065552
description	formed hose end piece A int. ø 50mm ø end piece B 70mm L 190mm warewashing L-shape equiv. no. 00004070		
For models:	240, LP60, LP60H, LP61, LP61H		



Part No.	511140	Ref. No.	00010540
description	formed hose warewashing L-shape equiv. no. 00010540		
For models:	120, 160		

with branch



Part No.	511859	Ref. No.	00013718
description	formed hose warewashing equiv. no. 00013718 with piggyback		
For models:	BD50, BE50, BE50T, C33, CW650-15, CW650-16, CW650-35, CW650-36, D30, D35, D36, D40, D40ELT, D40ELT-BT-BA, D40i, D40i-BT-BA, D40i-ELT-BT-BA, D45, D80, D80F, D85		



Part No.	511056	Ref. No.	00206911
description	formed hose warewashing with piggyback		
For models:	42, 42E, 48, 48E, 55, 55E		





1

Part No.	511057	Ref. No.	00206912
description	formed hose warewashing with piggyback		
For models:	42, 42E, 48, 48E, 55, 55E		



1

Part No.	511058	Ref. No.	00206909
description	formed hose warewashing with piggyback		
For models:	42, 42E, 48, 48E, 55, 55E, 60		



1

Part No.	511855	Ref. No.	00210956
description	pressure hose		



1

Part No.	511857	Ref. No.	00210956 00222108
description	pressure hose		
For models:	B11, B15, BD11, BD13, BD14, BD14alt, BD46, BD47, BE35		



1

Part No.	511863	Ref. No.	00206901
description	pressure hose		
For models:	42, 42E, 48, 48E, 55, 55E		

form S



1

Part No.	517498	Ref. No.	00018312
description	formed hose hose ext. ø 78mm hose int. ø 63mm L 310mm S-shape		
For models:	C44, C44dgt, C44dgt-elt, C66, C66dgt, C66dgt-elt, C77, D120, D120dgt		



1

Part No.	511856	Ref. No.	00222109
description	formed hose S-shape warewashing equiv. no. 00222109		
For models:	BD14, BD14alt, BD47, BE35		

miscellaneous



1

Part No.	511047	Ref. No.	00004110
description	formed hose warewashing equiv. no. 00004110		



for dishwashers

miscellaneous

1

Part No.	511468	Ref. No.	00200691
description	pressure hose		
For models:	42, 42E, 48, 48E, 55, 55E		

1 

Part No.	511467	Ref. No.	00003520 00013411
description	pressure hose L 1000mm		

1 

Part No.	511464	Ref. No.	00013340
description	pressure hose L 480mm ø 18mm		

1 

Part No.	511465	Ref. No.	00200641
description	pressure hose L 690mm ø 25mm		
For models:	42, 42E, 48, 48E, 55, 55E, 60		

fittings, hose and pipe connectors

fittings

T-pieces

miscellaneous

1 

Part No.	511499	Ref. No.	00000350
description	T-piece thread 3/8" brass L 58mm		

hose connectors

producer-specific

1 

Part No.	511071	Ref. No.	00002140
description	hose connector for drain		

valves and tank inlets

ball valves



producer-specific

ELFRAMO

1 

Part No.	514429	Ref. No.	13110004
description	ball valve connection 1" IT - 1" ET total length 71mm		
For models:	GSDT12, GSDT20, GST12, GST20		



accessories for 514429

	Part No.	540752	Ref. No.	00030450
	extension for outlet tap L 165mm			
	Part No.	694062	Ref. No.	00030470
	extension for outlet tap L 400mm			

1 

Part No.	542254	Ref. No.	131110001
description	ball valve connection 1" IT - tube ø25mm handle length without handlemm L 67mm		

1 

Part No.	540751	Ref. No.	00003041 13110001 (old version)	
description	ball valve connection 1" IT - tube ø25mm total length 59mm			
accessories for 540751				
	Part No.	540752	Ref. No.	00030450
	extension for outlet tap L 165mm			
	Part No.	540753	Ref. No.	—
	handle L 400mm for outlet tap			
	Part No.	694062	Ref. No.	00030470
	extension for outlet tap L 400mm			



			
1			
Part No.	540752	Ref. No.	00030450
description	extension for outlet tap L 165mm		
For models:	EM12, EM12+12, EM20, EM20+20, EM35		

			
1			
Part No.	694062	Ref. No.	00030470
description	extension for outlet tap L 400mm		
For models:	EM20+20-900, FE20, FE20+20, FE30, FE30+30, FG159, FG309, GM20+20-900, GW-MODULARI		

shut-off valves

universal

			
1			

Part No.	693107	Ref. No.	00003770 13100001
description	shut-off valve connection 1/2" 1/2" cold total length 54mm L1 27mm L2 30mm marking blue rosette thread G2 26x19G connection ø M4x0.7 ITmm		
For models:	Cybergel, EM240, EM360, EM480, EM612, EM-HT		

spare parts for 693107

	Part No.	514085	Ref. No.	—
	description	rosette connection 26x19G chrome-plated total lengthmm mounting pos.		

	Part No.	514086	Ref. No.	—
	description	hexagonal nut connection 26x19G brass total lengthmm mounting pos. H 6mm WS 34 Qty 1 pcs		

	Part No.	540672	Ref. No.	—
	description	gasket suitable for tap head		

	Part No.	547711	Ref. No.	—
	description	hood handle shaft intake ø 8mm marking blue metal H2 21mm D1 ø 33mm type D suitable for MONOLITH shaft length H1 8mm		

	Part No.	548168	Ref. No.	—
	description	star handle connection hot total lengthmm mounting pos. ø 57mm marking red		

	Part No.	548169	Ref. No.	—
	description	star handle connection cold total lengthmm mounting pos. chrome-plated ø 57mm		

accessories for 693107

	Part No.	514086	Ref. No.	—
	description	hexagonal nut connection 26x19G brass total lengthmm mounting pos. H 6mm WS 34 Qty 1 pcs		

water cycle components

pressure reduction valves

pressure reduction valves

universal

			
1			

Part No.	520871	Ref. No.	00074380 23200001 23200002
description	pressure reduction valve MALGORANI series Eurobrass 143 connection 1/2" default settingbar setting range 0.5-6bar p max 25bar t.max. 80°C brass		
For models:	EN, ET, ET020, ETA, ETE20, ETE21, ETE25, ETE27, ETS15		

supply filters

			
1			

Part No.	511485	Ref. No.	00000348 00003480 00003481
description	T-piece thread 1/2" -3/4" brass with filter H 100mm L 175mm		

ancillary products

clamps

hose clamps

DIN 3017 - W2

			
1			
Part No.	520115	Ref. No.	00003621 05100005 362A
description	hose clamp ø 25-40mm width 9mm Qty 10 pcs DIN 3017		



			
1			
Part No.	520116	Ref. No.	05100011
description	hose clamp ø 32-50mm width 9mm Qty 5 pcs DIN 3017		
For models:	D30, D80, ET, ET020, ETA		

			
1			
Part No.	520118	Ref. No.	00004051 05100002 05100004
description	hose clamp ø 50-70mm width 9mm Qty 5 pcs DIN 3017		
For models:	120, 160, 42, 42E, 48, 48E, 55, 55E, 60, 882, 885, 906, 908, B11, B15, BD11, BD13, BD14, BD14alt, BD22, BD50, BE35, BE40, BE50, BE50T, C33, C34, C34dgt, C44, C44dgt, C44dgt-elt, C66, C66dgt, C66dgt-elt, C77, CE24, CW650-15, CW650-16, CW650-35, CW650-36, D120, D120dgt, D30, D35, D36, D40, D40ELT, D40ELT-BT-BA, D40i, D40i-BTBA...(Other models you can see in the webshop)		

			
1			
Part No.	520454	Ref. No.	00004072 0000407B 05100008
description	hose clamp ø 70-90mm width 9mm Qty 5 pcs DIN 3017		
For models:	120, 160, 240, 908, BD13, BD14, BD46, BD47, BE50, C33, C34, C34dgt, C44, C44dgt, C44dgt-elt, C66, C66dgt, C66dgt-elt, C77, CE24, D120, D120dgt, D35, D40, D40ELT, D40ELT-BT-BA, D40i, D40i-BT-BA, D40i-ELT-BT-BA, D80, EN, ET, ET020, ETA, LP130, LP60, LP60H, LP61, LP61H, LP70, LPE100, LPE145		

			
1			
Part No.	520110	Ref. No.	05100006 376A
description	hose clamp ø 8-12mm width 9mm Qty 10 pcs DIN 3017		
For models:	120, 160, 240, 42, 42E, 48, 48E, 55, 55E, 60, 882, 885, 904, 906, 908, 912, C33, C44, C66, D30, E1200, E500, E700, EC1200, EC800, ES400, ES400-alt, ES400-sehr-alt, LP60, MR1200, MR600, MR800, MRC1100, MRC1400, MRC800, MRS400, MRS400-alt, SQ885, SQT80		

			
1			
Part No.	520117	Ref. No.	05100003
description	hose clamp stainless steel ø 40-60mm width 9mm Qty 5 pcs DIN 3017		
For models:	42, 42E, 48, 48E, 55, 55E, 60, B11, BD11, BD13, BD14, BD14alt, BD22, BD46, BD47, BD50, BE35, BE40, BE50, BE50T, C33, CW650-15, CW650-16, CW650-35, CW650-36, D30, D35, D36, D40, D40ELT, D40ELT-BT-BA, D40i, D40i-BT-BA, D40i-ELT-BT-BA, D45, D80, D80F, D85, ETE20, ETE21, ETE25, ETE27, ETS15		

DIN 3017 - W4

			
1			
Part No.	520120	Ref. No.	05100007
description	hose clamp SS W4 ø 12-20mm width 9mm Qty 1 pcs DIN 3017		

double wire clamps

			
1			
Part No.	520872	Ref. No.	00003751 05110001
description	hose clamp ø 7mm wire gauge ø 1mm Qty 1 pcs		
For models:	120, 160, 240, 42, 42E, 48, 48E, 55, 55E, 60, 882, 885, 904, 906, 908, 912, B11, B15, BD11, BD13, BD14, BD14alt, BD22, BD46, BD47, BD50, BE35, BE40, BE50, BE50T, C33, C34, C34dgt, C44, C44dgt, C44dgt-elt, C66, C66dgt, C66dgt-elt, C77, D120, D120dgt, D30, D35, D36, D40, D40ELT, D40i, D40i-BT-BA, D45...(Other models you can see in the webshop)		

measuring equipment

thermometers

built-in thermometers

			
1			
Part No.	541086	Ref. No.	32110003
description	thermometer mounting measurements 58x25.5mm 0 up to +120°C capillary pipe 2000mm probe ø 6mm probe L 23mm		
For models:	C44, C66, C77, D120, D40, D40i, D40i-BT-BA, D80, D80F		

1

Part No.	541095	Ref. No.	00057200 32110001
description	thermometer mounting measurements 58x25.5mm 0 up to +120°C capillary pipe 3000mm probe ø 6.5mm probe L 20mm		

ø40mm



1

Part No.	541037	Ref. No.	32110002
description	thermometer mounting ø 40mm t.max. 120°C 0 up to +120°C probe ø 6.5mm probe L 25mm capillary pipe 2000mm		
For models:	120, 160, 240, 882, 885, 904, 906, 908, 912, C44, C66, LP130, LP60, LP60H, LP61, LP61H, LP70, SQ885, SQT80		

ø52mm



1

Part No.	541065	Ref. No.	00006010 32100001
description	thermometer mounting ø 52mm t.max. 120°C 0 up to +120°C probe ø 6.5mm probe L 28mm capillary pipe 1500mm		
For models:	E1200, E500, E700, EC1200, EC800, LP100, LP145, LPE100, LPE145, MR1200, MR600, MR800, MRC1100, MRC1400, MRC800		



1

Part No.	541303	Ref. No.	00003053 32100002
description	thermometer mounting ø 52mm t.max. 200°C +150 up to +200°C probe ø 4mm probe L 75mm capillary pipe 1370mm		
For models:	GM12, GM12+12, GM20+20, GM20+20-900, GM25+25-900, GM2532, GM2542, GM25-900, GM35, GM50-900, GMD2532, GMD2542, GSdT12, GSdT20, GST12, GST20, GVM35, GVM35T, GW12, GW20, GWD12, GWD20, GWDT12, GWDT20, GW-MODULARI, GWT12, GWT20		

ø60mm



1

Part No.	541791	Ref. No.	00074420 32100003
description	thermometer mounting ø 60mm t.max. 120°C 0-120°C probe ø 6mm probe L 39mm capillary pipe 1500mm		
For models:	EN, ET, ET020, ETA		

fastening material

screws

countersunk screws



1

Part No.	560337	Ref. No.	01350001
description	countersunk screw thread M6 L 20mm WS 4 SS DIN 7991/ISO 10642 Qty 1 pcs intake hexagonal		
For models:	BD14, BD14alt, BD22, BD46, BD47, D36, D40, D40ELT, D40ELT-BT-BA, D40i, D40i-BT-BA, D40i-ELT-BT-BA, D45, D80, D80F, D85		

miscellaneous



1

Part No.	511494	Ref. No.	00000216 00002160
description	flat-headed bolt thread M5x0.8 thread L 7.8mm head ø 18mm intake slotted		
For models:	120, 160, 240, 42, 42E, 48, 48E, 55, 55E, 60, 882, 885, 904, 906, 908, 912, EG140S, EM-HT, EN, ET, ET020, ETA, SQ885, SQT80		



1

Part No.	519409	Ref. No.	00013785
description	screw		
For models:	BD14, BD14alt, BD22, BD46, BD47, D36, D40, D40ELT, D40ELT-BT-BA, D40i, D40i-BT-BA, D40i-ELT-BT-BA, D45, D80, D80F, D85		



nuts

hexagonal nuts

DIN 934 / ISO 4032/8673



1

Part No.	511212	Ref. No.	03100006
description	hexagonal nut thread M6 H 5mm WS 10 SS DIN/ISO DIN 934 / ISO 4032/8673 Qty 1 pcs		
For models:	42, 42E, 48, 48E, 55, 55E, 60, BD22, D30, D35, D36, D40, D40ELT, D40ELT-BT-BA, D40i, D40i-BT-BA, D40i-ELT-BT-BA, D45, FG12M, FG24M, GB10, GBD10		



1

Part No.	517174	Ref. No.	03100008
description	nut thread M8 H 6.5mm WS 13 SS DIN/ISO DIN 934 / ISO 4032/8673 Qty 1 pcs		
For models:	120, 160, 882, 885, 906, 908, C33, C34, C34dgt, C44, C44dgt, C44dgt-elt, C66, C66dgt, C66dgt-elt, C77, D120, D120dgt, D80, D80F, D85, EN, ET, ET020, ETA, ETE20, ETE21, ETE25, ETE27, ETS15		

washers

washers

DIN 125A



1

Part No.	560113	Ref. No.	02120006
description	plain washer ID \varnothing 6.4mm ED \varnothing 12mm thickness 1.6mm SS Qty 20 pcs DIN 125A for thread M6		
For models:	42, 42E, 48, 48E, 55, 55E, 60, BD14, BD14alt, BD22, D120, D30, D35, D36, D40, D40ELT, D40ELT-BT-BA, D40i, D40i-BT-BA, D40i-ELT-BT-BA, D45, D80		



1

Part No.	511481	Ref. No.	02120008
description	plain washer ID \varnothing 8.4mm ED \varnothing 16mm thickness 1.6mm zinc-coated steel Qty 1 pcs DIN 125A for thread M8		
For models:	B11, B15, BD11, BD13, BD14, BD22, C33, C34, C34dgt, D120, D120dgt, D30, D35, D40, D40ELT, D40ELT-BT-BA, D40i, D40i-BT-BA, D40i-ELT-BTBA, D80, D80F, D85, EN, ETS15		

miscellaneous



1

Part No.	511591	Ref. No.	02160100
description	disc ID \varnothing 16mm ED \varnothing 20mm thickness 1.5mm brass Qty 1 pcs		
For models:	BD14, BD46, BD47, D36, D40, D40ELT, D40ELT-BT-BA, D40i, D40i-BTBA, D40i-ELT-BT-BA, D45, D80, D80F, D85, ETS15		

fasteners

clamps

hose clamps

DIN 3017 - W2



1

Part No.	520115	Ref. No.	00003621 05100005 362A
description	hose clamp \varnothing 25-40mm width 9mm Qty 10 pcs DIN 3017		



1

Part No.	520116	Ref. No.	05100011
description	hose clamp \varnothing 32-50mm width 9mm Qty 5 pcs DIN 3017		
For models:	D30, D80, ET, ET020, ETA		



1

Part No.	520118	Ref. No.	00004051 05100002 05100004
description	hose clamp \varnothing 50-70mm width 9mm Qty 5 pcs DIN 3017		
For models:	120, 160, 42, 42E, 48, 48E, 55, 55E, 60, 882, 885, 906, 908, B11, B15, BD11, BD13, BD14, BD14alt, BD22, BD50, BE35, BE40, BE50, BE50T, C33, C34, C34dgt, C44, C44dgt, C44dgt-elt, C66, C66dgt, C66dgt-elt, C77, CE24, CW650-15, CW650-16, CW650-35, CW650-36, D120, D120dgt, D30, D35, D36, D40, D40ELT, D40ELT-BT-BA, D40i, D40i-BTBA...(Other models you can see in the webshop)		



1 

Part No.	520454	Ref. No.	00004072 0000407B 05100008
description	hose clamp ø 70-90mm width 9mm Qty 5 pcs DIN 3017		
For models:	120, 160, 240, 908, BD13, BD14, BD46, BD47, BE50, C33, C34, C34dgt, C44, C44dgt, C44dgt-elt, C66, C66dgt, C66dgt-elt, C77, CE24, D120, D120dgt, D35, D40, D40ELT, D40ELT-BT-BA, D40i, D40i-BT-BA, D40i-ELT-BT-BA, D80, EN, ET, ET020, ETA, LP130, LP60, LP60H, LP61, LP61H, LP70, LPE100, LPE145		

1 

Part No.	520110	Ref. No.	05100006 376A
description	hose clamp ø 8-12mm width 9mm Qty 10 pcs DIN 3017		
For models:	120, 160, 240, 42, 42E, 48, 48E, 55, 55E, 60, 882, 885, 904, 906, 908, 912, C33, C44, C66, D30, E1200, E500, E700, EC1200, EC800, ES400, ES400-alt, ES400-sehr-alt, LP60, MR1200, MR600, MR800, MRC1100, MRC1400, MRC800, MRS400, MRS400-alt, SQ885, SQT80		

1 

Part No.	520117	Ref. No.	05100003
description	hose clamp stainless steel ø 40-60mm width 9mm Qty 5 pcs DIN 3017		
For models:	42, 42E, 48, 48E, 55, 55E, 60, B11, BD11, BD13, BD14, BD14alt, BD22, BD46, BD47, BD50, BE35, BE40, BE50, BE50T, C33, CW650-15, CW650-16, CW650-35, CW650-36, D30, D35, D36, D40, D40ELT, D40ELT-BT-BA, D40i, D40i-BT-BA, D40i-ELT-BT-BA, D45, D80, D80F, D85, ETE20, ETE21, ETE25, ETE27, ETS15		

DIN 3017 - W4

1 

Part No.	520120	Ref. No.	05100007
description	hose clamp SS W4 ø 12-20mm width 9mm Qty 1 pcs DIN 3017		

double wire clamps

1 

Part No.	520872	Ref. No.	00003751 05110001
description	hose clamp ø 7mm wire gauge ø 1mm Qty 1 pcs		
For models:	120, 160, 240, 42, 42E, 48, 48E, 55, 55E, 60, 882, 885, 904, 906, 908, 912, B11, B15, BD11, BD13, BD14, BD14alt, BD22, BD46, BD47, BD50, BE35, BE40, BE50, BE50T, C33, C34, C34dgt, C44, C44dgt, C44dgt-elt, C66, C66dgt, C66dgt-elt, C77, D120, D120dgt, D30, D35, D36, D40, D40ELT, D40i, D40i-BT-BA, D45...(Other models you can see in the webshop)		

consumables

fuses

fine fuses

ø10x38mm 400V

1 

Part No.	358041	Ref. No.	00060970
description	fine fuse size ø10x38mm 20A slow-acting rated 400V type aM Qty 1 pcs		
For models:	EN, ET, ET020, ETA, LPE100, LPE145		

1 

Part No.	358030	Ref. No.	00060980
description	fine fuse size ø10x38mm 32A slow-acting rated 400V type aM Qty 1 pcs		
For models:	EN, ET, ET020, ETA, LPE100, LPE145		

ø10x38mm 500V

1 

Part No.	358038	Ref. No.	00060960 37130999
description	fine fuse size ø10x38mm 10A slow-acting rated 500V type aM Qty 1 pcs		
For models:	120, 160, 240, 882, 885, 904, 906, 908, 912, CW650-15, CW650-16, CW650-35, CW650-36, Cybergel, EB12, EB12+12, EG140S, EM240, EM360, EM480, EM612, EM-HT, EN, ES12, ESD12, ET, ET020, ETA, ETE20, ETE21, ETE25, ETE27, ETS15, LPE100, LPE145, SQ885, SQT80		

1 

Part No.	358040	Ref. No.	00006261
description	fine fuse size ø10x38mm 16A slow-acting rated 500V type aM Qty 1 pcs		

GASTROPARTS.COM

