



GASTROPARTS

Elektra

- [EN]** Equipment
- [DE]** Geräte
- [ES]** Aparatos
- [FR]** Équipement
- [IT]** Attrezzature
- [PL]** Urządzenia
- [RU]** Оборудование

✉ gastroparts@gastroparts.com

☎ +48 56 657 00 66

📘 fb.com/gastroparts.global

GASTROPARTS.COM











heating elements

heating elements for coffee machine

			
1			
Part No.	417174	Ref. No.	01195035
description	heating element 2000W 230V heating circuits 3 mounting \varnothing 42mm hole distance 74mm L 152mm W 35mm H 58mm L1 38mm L2 56mm L3 58mm H1 35mm hole \varnothing 10mm tube \varnothing 8mm thermostat sleeves \varnothing 4mm length thermostat sleeves 150mm number of thermostat sleeves 1 connection M3x0.6 immersion heater 2 hole flange		

			
1			
Part No.	417215	Ref. No.	01197035
description	heating element 2500W 230V heating circuits 3 hole distance 74mm L 150mm W 31mm H 57mm L1 33mm L2 67mm L3 50mm H1 35mm H2 22mm tube \varnothing 8mm thermostat sleeves \varnothing 5mm length thermostat sleeves 135mm thermostat sleeve eccentric, clinging connection M3 suitable for Verticale 2GR		
accessories for	417215		
		Part No. 527169	Ref. No. —
		hexagonal nut thread M3 H 2.8mm WS 5.5 brass Qty 1 pcs	
		Part No. 560110	Ref. No. —
		plain washer ID \varnothing 3.2mm ED \varnothing 7mm thickness 0.5mm SS Qty 20 pcs DIN 125A for thread M3	
		Part No. 560130	Ref. No. —
		hexagonal nut thread M3 H 2.4mm WS 5.5 SS DIN/ISO DIN 934 / ISO 4032/8673 Qty 20 pcs	

			
1			
Part No.	417155	Ref. No.	00127035
description	heating element 3000W 230V heating circuits 3 mounting \varnothing 43mm hole distance 74mm L 315mm W 32mm H 45mm L1 35mm L2 60mm L3 220mm H1 33mm H2 12mm hole \varnothing 10mm tube \varnothing 8mm connection M3 immersion heater 2 hole flange		
accessories for	417155		
		Part No. 527169	Ref. No. —
		hexagonal nut thread M3 H 2.8mm WS 5.5 brass Qty 1 pcs	
		Part No. 560110	Ref. No. —
		plain washer ID \varnothing 3.2mm ED \varnothing 7mm thickness 0.5mm SS Qty 20 pcs DIN 125A for thread M3	
		Part No. 560130	Ref. No. —
		hexagonal nut thread M3 H 2.4mm WS 5.5 SS DIN/ISO DIN 934 / ISO 4032/8673 Qty 20 pcs	

			
1			
Part No.	417295	Ref. No.	02159035
description	heating element 3500W 230/400V heating circuits 3 mounting \varnothing 42mm hole distance 74mm L 325mm W 35mm H 60mm L1 47mm L2 53mm L3 225mm H1 35mm H2 25mm hole \varnothing 10mm tube \varnothing 8mm thermostat sleeves \varnothing 5mm length thermostat sleeves 198mm thermostat sleeve eccentric, clinging number of thermostat sleeves 1 connection M3 dry heating element 2 hole flange		

			
1			
Part No.	417265	Ref. No.	01992035
description	heating element 5500W 230/400V heating circuits 3 mounting \varnothing 42mm hole distance 74mm L 503mm W 35mm H 62mm L1 44mm L2 64mm L3 395mm H1 35mm H2 27mm hole \varnothing 9.5mm tube \varnothing 8mm thermostat sleeves \varnothing 5mm length thermostat sleeves 190mm thermostat sleeve eccentric, clinging number of thermostat sleeves 1 connection 3 immersion heater 2 hole flange		

			
1			
Part No.	417175	Ref. No.	01192035
description	heating element 800W 220V heating circuits 1 \varnothing 50mm H 41mm W1 38mm H1 19mm H2 22mm mounting distance 32mm thread 1/4" stainless steel windings 2 tube \varnothing 6.3mm immersion heater 2 hole fixing connection male faston 6.3mm		
spare parts for	417175		
		Part No. 510417	Ref. No. —
		flat gasket fibre ED \varnothing 20mm ID \varnothing 14mm thickness 2mm Qty 1 pcs	
accessories for	417175		
		Part No. 361182	Ref. No. —
		nut thread 1/4" H 5mm nickel-plated brass WS 17 Qty 1 pcs	
		Part No. 520228	Ref. No. —
		tooth lock washer ID \varnothing 15.3mm ED \varnothing 24mm steel Qty 1 pcs for thread M14	
		Part No. 550262	Ref. No. —
		flat gasket copper ED \varnothing 20mm ID \varnothing 14mm thickness 2mm	

accessories

sealing washers

fibre gaskets

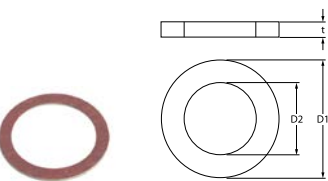
			
1			
Part No.	528171	Ref. No.	00499035
description	flat gasket fibre ED \varnothing 55mm ID \varnothing 42mm thickness 2mm Qty 1 pcs		

1 electric components



O-rings

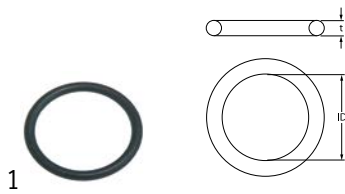

Part No. 510408 **Ref. No.** 00174035

description O-ring EPDM thickness 5.34mm ID ø 47mm Qty 1 pcs

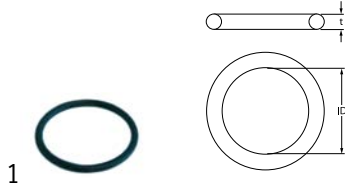

Part No. 510409 **Ref. No.** 01917035

description O-ring EPDM thickness 5.34mm ID ø 56.52mm Qty 1 pcs

protection caps



Part No. 520483 **Ref. No.** 00276014

description protection cap for heating element ø 48mm plastic L 50mm

thermostats

bi-metal thermostats

safety bi-metal thermostats



Part No. 390312 **Ref. No.** 01194035

description bi-metal safety thermostat 1-pole connection F6.3 2 hole fixing

bi-metal thermostats



Part No. 390129 **Ref. No.** 00700035

description bi-metal thermostat hole distancemm switch-off temp. 125°C 1NC 1-pole 16A connection F6.3 M4



Part No. 390153 **Ref. No.** 00277035

description bi-metal thermostat hole distancemm switch-off temp. 135°C 1NC 1-pole 16A connection F6.3 M4



Part No. 390327 **Ref. No.** 00702035

description bi-metal thermostat hole distancemm switch-off temp. 150°C 1NC 1-pole 16A connection F6.3 M4



Part No. 390128 **Ref. No.** 00701035

description bi-metal thermostat hole distancemm switch-off temp. 95°C 1NC 1-pole 16A connection F6.3 M4

control and safety thermostats

EGO

safety thermostats

55.32_ series

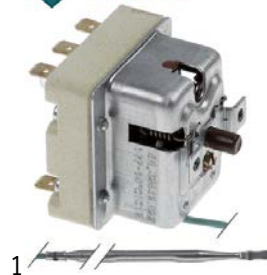

Part No. 390324 **Ref. No.** 02790035

description safety thermostat switch-off temp. 169°C 3-pole 3NC 20A probe ø 4mm probe L 128mm capillary pipe 890mm capillary pipe isolated 210/210mm gland nut probe SS

switches and momentary switches

rocker/momentary rocker switches

30x11mm



Part No. 301038 **Ref. No.** 00632034

description rocker switch mounting measurements 30x11mm green 1NO/indicator light 250V 16A connection male faston 6.3mm



30x22mm



1

Part No.	301001	Ref. No.	00492035
description	rocker switch mounting measurements 30x22mm red 2NO 250V 16A illuminated 0-1 connection male faston 6.3mm ambient temperature max. 125/55°C protection IP65		

accessories for 301001



Part No.	301036	Ref. No.	—
description	protective cover internal size 30x22mm for rocker switch mounting measurementsmm		



1

Part No.	301060	Ref. No.	01603035
description	rocker switch mounting measurements 30x22mm red 2NO 250V 16A illuminated connection male faston 6.3mm ambient temperature max. 125/55°C protection IP40		

push/momentary push switches

28.5x28.5mm



1

Part No.	346019	Ref. No.	00746034
description	push switch mounting measurements 28.5x28.5mm green/black 2NO 250V 16A cup connection male faston 6.3mm ambient temperature max. 150/75°C protection IP40 with indicator		

30x22mm



1

Part No.	301044	Ref. No.	01606034
description	momentary push switch mounting measurements 30x22mm green 2NO 250V 16A illuminated		



1

Part No.	301040 ¹	Ref. No.	00631034
description	push switch mounting measurements 30x22mm green 2NO 250V 16A illuminated connection male faston 6.3mm ambient temperature max. 85°C protection IP40		

¹illuminated

ø25mm



1

Part No.	346044	Ref. No.	01606034
description	momentary push switch mounting ø 25mm black 2NO 250V 16A water connection male faston 6.3mm ambient temperature max. 85°C protection IP40		



1

Part No.	346040	Ref. No.	00631034
description	momentary push switch mounting ø 25mm red 2NO 250V 16A water connection male faston 6.3mm ambient temperature max. 85°C protection IP40		



1

Part No.	346039	Ref. No.	01607034
description	push switch mounting ø 25mm black 2NO 250V 16A coffee connection male faston 6.3mm ambient temperature max. 85°C protection IP40		



1

Part No.	346038	Ref. No.	00632034
description	push switch mounting ø 25mm red 2NO 250V 16A coffee connection male faston 6.3mm ambient temperature max. 85°C protection IP40		

microswitches

roller actuated

roller 0°



1

Part No.	346370	Ref. No.	01903035
description	microswitch with roller plunger 230V 16A 1CO connection screw L1 49mm ambient temperature max. 125°C thread L 14mm thread M10 mounting distance 25mm actuating force: 300g type MV15-2		



system switches (ROLD)



1

Part No.	346498	Ref. No.	00740035
description	element holder mounting measurements 28.5x28.5mm black single element holder		



1

Part No.	346032	Ref. No.	00743073
description	push button ø 23mm black flash with lens		



1

Part No.	345722	Ref. No.	01221035
description	switch 1NO 250V 16A connection male faston 6.3mm		



1

Part No.	345720	Ref. No.	01222035
description	switch 2NO 250V 16A connection male faston 6.3mm		

key lock switches



1

Part No.	400298	Ref. No.	00388035 03196035
description	key lock switch		



1

Part No.	400297	Ref. No.	00387035 03195035
description	key lock switch 1 group thread M12x1 1NO mounting ø 12mm cable length 300mm		



1

Part No.	402219	Ref. No.	00391035
description	key lock switch 1 group thread M12x1 1NO mounting ø 12mm cable length 500mm		



1

Part No.	400299	Ref. No.	03197035 0389035
description	key lock switch mounting ø 11.6mm 3-group		

rotary switches

BREMAS

A1700 series



1

Part No.	347085	Ref. No.	00056035
description	rotary switch 2 0-1 sets of contacts 2 type CA0170002V 400V 20A shaft ø 5x5mm shaft L 18mm shaft square connection screw		



1

Part No.	347198 ¹	Ref. No.	02019035
description	rotary switch 2 0-1 sets of contacts 4 type CA0200004V 400V 20A shaft ø 5x5mm shaft L 19mm shaft square connection screw		

¹incl. rubber protective sleeve

1

Part No.	346004	Ref. No.	00056035
description	rotary switch 20A shaft L 23mm 2 operating positions 2-pole shaft 5x5mm screw		



1

Part No.	347274	Ref. No.	02020035
description	rotary switch 3 0-1-2 sets of contacts 6 type CS0178623 400V 20A shaft ø 5x5mm shaft L 23mm shaft square connection screw		

accessories



1

Part No.	111315	Ref. No.	01965058
description	knob ø 28/48mm shaft ø 5x5mm brown H 22mm L 40mm		



			
1			
Part No.	527259	Ref. No.	01965057
description	knob push-in ø 34/60mm shaft ø 5x5mm black H 21.4mm L 49mm		

lamps

indicator lights

indicator lights 2-piece (lens and indicator lamp)

rings for socket type SC-1

			
1			
Part No.	359242	Ref. No.	01311035
description	frame chrome-plated		

indicator lights (complete)

ø10mm

with screw socket

			
1			
Part No.	359238	Ref. No.	01312035
description	indicator light ø 10mm 230V green connection male faston 6.3mm		



			
1			
Part No.	359237	Ref. No.	00073035
description	indicator light ø 10mm 230V red connection male faston 6.3mm		

relays



power relays

with male contacts

bullet connectors, 8 contacts

			
1			
Part No.	380134	Ref. No.	00681035
description	power relays Italiana Relè 230VAC 10A 2CO connection plug-in connection round 8-pole manuf. no. C42-230VAC 90.26/ZVE8 250V		
accessories for	380134		
	Part No.	380137	Ref. No.
			—
	relay socket 8-pole connection plug-in connection round 8-pole dimensions 65x28x40mm 380V voltage AC 10A Italiana Relè manuf. no. ZVE8		
	Part No.	380638	Ref. No.
			—
	relay socket 8-pole dimensions 51x41x23mm 250V 10A FINDER manuf. no. 90.26		

plug-in/print relays

			
1			
Part No.	380662	Ref. No.	02021035
description	print relay 250VAC 1CO at 250V 10A connection pins raster size 3.5mm		
accessories for	380662		
	Part No.	380663	Ref. No.
			—
	relay socket 250V voltage AC 10A FINDER manuf. no. 95.83.3		

relay sockets

			
1			
Part No.	380910	Ref. No.	02022035
description	relay socket 5-pole 250V 10A FINDER manuf. no. 95.63		

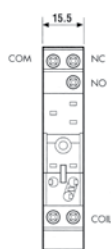



			
1			
Part No.	380909	Ref. No.	00683035
description	relay socket 8-pole 250V 10A FINDER manuf. no. 90.22		

level relays

GICAR

			
1			
Part No.	402392	Ref. No.	00189035
description	level controller 230V voltage AC 50/60Hz 10A connection male faston 6.3mm type NRL30/1E-2C/F		

keypads

keypad units

			
1			
Part No.	400361	Ref. No.	00384035 EL-384
description	keypad unit		

			
1			
Part No.	400057	Ref. No.	03154034
description	keypad unit buttons 7 black		

			
1			
Part No.	400357	Ref. No.	02901034
description	keypad unit buttons 7 blue type DOS TG 1GR+RL 230V		

			
1			
Part No.	400059	Ref. No.	01955034
description	keypad unit buttons 7 brown type DOS TG 1GR+RL 230V		

solenoid valves

solenoid valves (water)

metal

PARKER

spare parts and accessories

valve bodies

			
1			
Part No.	370568	Ref. No.	01847035
description	solenoid valve body PARKER 2-ways type VE-140 pressure range 0-10bar		

				
1				
Part No.	370062	Ref. No.	EK02	
description	solenoid valve body PARKER 3-ways outer cone			
accessories for	370062			
	Part No.	371029	Ref. No.	—
	solenoid coil PARKER 230VAC 9VA coil type ZB09 seat ø 14mm H 33mm W 34mm D 43mm			
	Part No.	371030	Ref. No.	—
	solenoid coil 24VDC 12VA coil type ZB12 seat ø 14mm			
	Part No.	371033	Ref. No.	—
	solenoid coil PARKER 230VAC 9VA coil type YB09 with cable seat ø 14mm			
	Part No.	371036	Ref. No.	—
	solenoid coil 24VAC 9VA coil type ZB09 seat ø 14mm			
	Part No.	371095	Ref. No.	—
	O-ring Viton thickness 1.78mm ID ø 6.07mm Qty 1 pcs			

Table continues overleaf



accessories for	370062			
	Part No.	371100	Ref. No.	—
	O-ring silicone thickness 1.78mm ID ø 6.07mm Qty 1 pcs			

pressure switches

for coffee machines

ø 38mm



1

Part No.	541020	Ref. No.	01344035
description	pressure control ø 38mm pressure range 0.5-1.2bar coffee machine parts pressure connection vertical preset at 1bar 16A 250V connection 1/4" pressure connection 1/4" GAS		

miscellaneous



1

Part No.	541021	Ref. No.	00049035
description	pressure control pressure range adjustable 0.5-1.4bar connection 1/4" 30A 3-pole type P302 coffee machine parts SIRAI		

accessories for	541021		
-----------------	--------	--	--



Part No.	550262	Ref. No.	—
	flat gasket copper ED ø 20mm ID ø 14mm thickness 2mm		



Part No.	890100	Ref. No.	—
	PTFE tape reel L 12m W 12mm -200 up to +260°C approval DINDVGW, KTW temperature-resistant, elastic for fine thread thickness 0.1mm		

electrodes



1

Part No.	400214	Ref. No.	00191035
description	level electrode 1/4" total length 140mm probe L 112mm insulated probe length 26mm connection male faston 6.3mm stainless steel ø 2.5mm		



1

Part No.	400523	Ref. No.	01108034
description	level electrode total length 111mm probe L 81mm with housing ø 14mm		



1

Part No.	400573	Ref. No.	01110034 01971034
description	level electrode total length 130mm probe L 102mm with housing ø 14mm		

pumps

booster pumps II

pump heads

FLUID-O-TECH



1

Part No.	500177	Ref. No.	00046035
description	pump head PA204X FLUID-O-TECH L 82mm 200l/h connection 3/8" GAS with filter an bypass brass clip connection for coffee machine shaft ø 4.8x11mm		

equipment-specific units

for vegetable slicers

miscellaneous



1

Part No.	110703	Ref. No.	00469035
description	cylindrical handle thread M10 ø 28mm L 87mm		

for cheese graters

miscellaneous



1

Part No.	110703	Ref. No.	00469035
description	cylindrical handle thread M10 ø 28mm L 87mm		



for espresso machines

filter holders

filter holders standard

filter holder without spout



1

Part No.	525991	Ref. No.	N/A
description	filter holder suitable for ELEKTRA without outlet mounting \varnothing 82.5mm outlet 3/8" ID \varnothing 61.8mm wedge height 8.5mm wedge position horizontal number of wedges 2 lever inclined		

filter holders short



1

Part No.	529181	Ref. No.	00187021
description	filter holder chrome-plated		



1

Part No.	529180	Ref. No.	00187019
description	filter holder mounting \varnothing 64mm hole \varnothing 4mm ID \varnothing 51mm handle M8x1.25 wedge height 8mm wedge position horizontal number of wedges 2 lever straight brass polished		



1

Part No.	529198	Ref. No.	00061021 02152021
description	filter holder mounting \varnothing 82.5mm outlet 3/8" ID \varnothing 61.8mm handle M12x1.75 wedge height 9.5mm wedge position horizontal number of wedges 2 lever inclined chrome-plated brass		

handles

with external thread



1

Part No.	529129	Ref. No.	02900014
description	handle for filter holder \varnothing 36.5mm thread M12x1.75 thread L 15mm L 110mm black		



1

Part No.	529199	Ref. No.	01897035
description	handle for filter holder \varnothing 36.5mm thread M12x1.75 thread L 15mm L 110mm brown		

with bore



1

Part No.	529793	Ref. No.	01899035
description	handle		



1

Part No.	529185	Ref. No.	00177005 00177014
description	handle \varnothing 36mm aperture 10mm L 125mm brown wood		

screws



1

Part No.	529182	Ref. No.	00186035
description	threaded rod		

spouts

with thread 3/8"



1

Part No.	529003	Ref. No.	01308021
description	filter holder spout thread 3/8" 1-way curved/long outlet distance thread L 5mm		



1

Part No.	529161	Ref. No.	00064021
description	filter holder spout thread 3/8" adjustable curved H 34mm outlet distance 45mm cups 2		



accessories



1

Part No.	529200	Ref. No.	00526021
description	extension chrome-plated brass		

filters

for 1 cup



1

Part No.	529178	Ref. No.	00164035
description	coffee filter ø 58mm mounting ø 51mm H 22mm cups 1 amount of coffee 6g		



1

Part No.	526261	Ref. No.	01796035
description	coffee filter ø 70mm mounting ø 60.5mm H 20.5mm cups 1 amount of coffee 6.5g		



1

Part No.	529196	Ref. No.	00065035
description	coffee filter ø 70mm mounting ø 60.6mm H 24.5mm cups 1 amount of coffee 7g		



1

Part No.	527631	Ref. No.	N/A
description	coffee filter ø 70mm mounting ø 60.7mm H 17mm cups 1 amount of coffee 8g		

for 2 cups



1

Part No.	529179	Ref. No.	00163035
description	coffee filter ø 58mm mounting ø 51mm H 26mm cups 2 amount of coffee 12g		



1

Part No.	529197	Ref. No.	00066035
description	coffee filter ø 70mm mounting ø 60mm H 24.5mm cups 2 amount of coffee 14g		

filter holder springs



1

Part No.	529079	Ref. No.	013040335 01304035
description	filter holder spring L 70mm W 60mm wire gauge ø 1.3mm for espresso filter holder		

miscellaneous

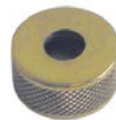

1

Part No.	529184	Ref. No.	01367019
description	nut		

brewing units

shower screens

flat



1

Part No.	529193	Ref. No.	01208035
description	shower screen ø 52.1mm hole ø 6.3mm		
accessories for	529193		
	Part No.	Ref. No.	01206035
	 countersunk screw thread M5 L 16mm SS DIN 963/ISO 2009 Qty 1 pcs intake slotted head ø 9mm		



with upstand



1

Part No.	529177	Ref. No.	00175035
description	shower screen ø 48mm H 14mm		

screws



1

Part No.	560300	Ref. No.	01206035
description	countersunk screw thread M5 L 16mm SS DIN 963/ISO 2009 Qty 1 pcs intake slotted head ø 9mm		

filter holder gaskets

O-rings



1

Part No.	510409	Ref. No.	01917035
description	O-ring EPDM thickness 5.34mm ID ø 56.52mm Qty 1 pcs		

shim gaskets



1

Part No.	531251	Ref. No.	—
description	shim gasket D1 ø 66mm D2 ø 58mm thickness 0.8mm paper Qty 20 pcs		

brewing units with solenoid valve

nozzle holders



1

Part No.	526420	Ref. No.	01335014
description	nozzle holder thread M5 IT M5 L 10.3mm brass WS 8		

filters

accessories



1

Part No.	526419	Ref. No.	00110014
description	filter support for brewing unit D1 ø 11mm D2 ø 18mm D3 ø 16.5mm L 5.6mm		

brewing units manual

components

gaskets



1

Part No.	529174	Ref. No.	00172035
description	gasket		



1

Part No.	529795	Ref. No.	01245035 02862035
description	gasket D1 ø 13mm D2 ø 4mm thickness 4mm coffee machine		



1

Part No.	529175	Ref. No.	00173035
description	gasket ED ø 41mm ID ø 28mm H 6mm		

brewing units with lever

complete



1

Part No.	525005	Ref. No.	00131039
description	brewing unit complete suitable for ELEKTRA		



			
1			
Part No.	525006	Ref. No.	00131038
description	brewing unit complete suitable for ELEKTRA		

components

nozzles

with thread

			
1			
Part No.	529188	Ref. No.	01336014
description	nozzle bore ø 0.9mm		

screw connections

			
1			
Part No.	526386	Ref. No.	00026014
description	screw cap thread M30x1.5 ID ø 15mm L 21mm brass WS 12		

			
1			
Part No.	526385	Ref. No.	00921021
description	screw cap thread M30x1.5 ID ø 15mm L 30mm chrome-plated brass WS 17		

gaskets

			
1			
Part No.	529190	Ref. No.	01228035
description	O-ring Viton thickness 2.62mm ID ø 31.42mm Qty 1 pcs		

water dispersions

water dispersions

group 3

			
1			
Part No.	529194	Ref. No.	01252014
description	water distributor ø 57mm H 8.5mm 10 holes hole ø 1.2mm mounting ø 5mm brass		

safety valves

safety valves

3/8"

			
1			
Part No.	529312	Ref. No.	01618034
description	safety valve connection 3/8" triggering pressure 1.8bar		

expansion valves

			
1			
Part No.	529341	Ref. No.	00422034
description	expansion valve T1: 1/8" ET T2: 1/8" ET L 24mm		

drain pans

drain pans

			
1			
Part No.	526373	Ref. No.	01262014
description	drain pan L 98mm W 70mm H 48mm		



aerators and air bleeders



1

Part No.	529303	Ref. No.	00200034
-----------------	--------	-----------------	----------

description	aerator and air bleeder connection 1/4" only steam
--------------------	--

spare parts for	529303
------------------------	--------



Part No.	528687	Ref. No.	—
-----------------	--------	-----------------	---

description	O-ring Viton thickness 1.78mm ID ø 3.69mm Qty 1 pcs
--------------------	---

boilers

gaskets

O-rings

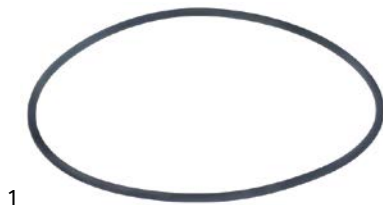

1

Part No.	526394	Ref. No.	01994035
-----------------	--------	-----------------	----------

description	boiler gasket Viton thickness 3.53mm ID ø 129.8mm Qty 1 pcs
--------------------	---

steam/water taps

steam/water taps

steam/water taps



1

Part No.	529811	Ref. No.	00690038
-----------------	--------	-----------------	----------

description	steam/water tap brass
--------------------	-----------------------

spare parts for	529811
------------------------	--------



Part No.	526404	Ref. No.	01891019
-----------------	--------	-----------------	----------

description	tap body T1: M18x1 T2: M20x1 T3: TR20 left brass polished L 49mm
--------------------	--



Part No.	529813	Ref. No.	01898035
-----------------	--------	-----------------	----------

description	star handle shaft 7x7mm ø 58mm L 19mm brown thermoplastic
--------------------	---



Part No.	529814	Ref. No.	00953030
-----------------	--------	-----------------	----------

description	disc for knob ø 33.8mm ELEKTRA
--------------------	--------------------------------



1

Part No.	529812	Ref. No.	00690039
-----------------	--------	-----------------	----------

description	steam/water tap chrome-plated
--------------------	-------------------------------

spare parts for	529812
------------------------	--------



Part No.	526399	Ref. No.	01891021
-----------------	--------	-----------------	----------

description	tap body T1: M18x1 T2: M20x1 T3: TR20 left chrome-plated L 49mm
--------------------	---



Part No.	529813	Ref. No.	01898035
-----------------	--------	-----------------	----------

description	star handle shaft 7x7mm ø 58mm L 19mm brown thermoplastic
--------------------	---



Part No.	529814	Ref. No.	00953030
-----------------	--------	-----------------	----------

description	disc for knob ø 33.8mm ELEKTRA
--------------------	--------------------------------

steam taps

steam taps (complete)



1

Part No.	529790	Ref. No.	00958038
-----------------	--------	-----------------	----------

description	steam tap brass
--------------------	-----------------

spare parts for	529790
------------------------	--------



Part No.	526417	Ref. No.	00048014
-----------------	--------	-----------------	----------

description	shaft for steam-/water-tap ø 5mm D2 ø 4mm L 65mm thread M4 SS
--------------------	---



Part No.	526418	Ref. No.	01457015
-----------------	--------	-----------------	----------

description	lever L 36mm T1: M5 T2: M8 ø 13.5mm
--------------------	-------------------------------------



1

Part No.	526377	Ref. No.	02906039
-----------------	--------	-----------------	----------

description	steam tap complete chrome-plated blue/black
--------------------	---





1

Part No.	526376	Ref. No.	01990039
description	steam tap complete chrome-plated white/brown		







1

Part No.	526374	Ref. No.	00958034	
description	steam tap complete swing lever brass			
spare parts for	526374			
	Part No.	526417	Ref. No.	00048014
	shaft for steam-/water-tap ø 5mm D2 ø 4mm L 65mm thread M4 SS			
	Part No.	526418	Ref. No.	01457015
	lever L 36mm T1: M5 T2: M8 ø 13.5mm			





1

Part No.	529808	Ref. No.	00945034	
description	steam tap complete swing lever brass			
spare parts for	529808			
	Part No.	526384	Ref. No.	01891014
	tap body T1: M18x1 T2: M20x1 T3: TR20 left brass L 49mm			
	Part No.	526417	Ref. No.	00048014
	shaft for steam-/water-tap ø 5mm D2 ø 4mm L 65mm thread M4 SS			
	Part No.	526418	Ref. No.	01457015
	lever L 36mm T1: M5 T2: M8 ø 13.5mm			



1

Part No.	529789	Ref. No.	00958039	
description	steam tap complete swing lever chrome-plated			
spare parts for	529789			
	Part No.	526417	Ref. No.	00048014
	shaft for steam-/water-tap ø 5mm D2 ø 4mm L 65mm thread M4 SS			
	Part No.	526418	Ref. No.	01457015
	lever L 36mm T1: M5 T2: M8 ø 13.5mm			

components

shafts



1

Part No.	526417	Ref. No.	00048014
description	shaft for steam-/water-tap ø 5mm D2 ø 4mm L 65mm thread M4 SS		

bushes



1

Part No.	529804	Ref. No.	01913014
description	bush		

gaskets



1

Part No.	529796	Ref. No.	01178035
description	gasket D1 ø 12mm D2 ø 5mm thickness 5mm PTFE coffee machine		



1

Part No.	529795	Ref. No.	01245035 02862035
description	gasket D1 ø 13mm D2 ø 4mm thickness 4mm coffee machine		



gasket supports



1

Part No.	529794	Ref. No.	00042014
-----------------	--------	-----------------	----------

description	gasket support		
--------------------	----------------	--	--



1

Part No.	526391	Ref. No.	00047014
-----------------	--------	-----------------	----------

description	piston for steam-/water-tap \varnothing 13mm L 11mm thread M4		
--------------------	---	--	--

spring guides



1

Part No.	529797	Ref. No.	00045014
-----------------	--------	-----------------	----------

description	spring guide		
--------------------	--------------	--	--

springs



1

Part No.	529803	Ref. No.	01912035
-----------------	--------	-----------------	----------

description	compression spring \varnothing 10.9mm L 16mm wire gauge \varnothing 1.8mm		
--------------------	---	--	--



1

Part No.	529798	Ref. No.	01189035
-----------------	--------	-----------------	----------

description	compression spring \varnothing 12.4mm L 36mm wire gauge \varnothing 1.8mm		
--------------------	---	--	--

tap bodies



1

Part No.	529780	Ref. No.	00150021
-----------------	--------	-----------------	----------

description	tap body		
--------------------	----------	--	--



1

Part No.	529781	Ref. No.	00150019
-----------------	--------	-----------------	----------

description	tap body		
--------------------	----------	--	--



1

Part No.	526384	Ref. No.	01891014
-----------------	--------	-----------------	----------

description	tap body T1: M18x1 T2: M20x1 T3: TR20 left brass L 49mm		
--------------------	---	--	--



1

Part No.	526404	Ref. No.	01891019
-----------------	--------	-----------------	----------

description	tap body T1: M18x1 T2: M20x1 T3: TR20 left brass polished L 49mm		
--------------------	--	--	--



1

Part No.	526399	Ref. No.	01891021
-----------------	--------	-----------------	----------

description	tap body T1: M18x1 T2: M20x1 T3: TR20 left chrome-plated L 49mm		
--------------------	---	--	--

levers



1

Part No.	526418	Ref. No.	01457015
-----------------	--------	-----------------	----------

description	lever L 36mm T1: M5 T2: M8 \varnothing 13.5mm		
--------------------	---	--	--

knob adaptors





1

Part No.	526411	Ref. No.	00948021
-----------------	--------	-----------------	----------

description	knob adaptor thread TR20 left shaft 7x7mm L 40mm handle M4 chrome-plated brass		
--------------------	--	--	--





nuts			
			
1			
Part No.	526498	Ref. No.	00950014
description	hexagonal nut thread TR20 left H 5mm WS 25 brass		

screws			
			
1			
Part No.	526389	Ref. No.	00952015
description	screw for stop		

union nuts			
			
1			
Part No.	529806	Ref. No.	00946021
description	union nut chrome-plated		

			
1			
Part No.	529792	Ref. No.	00947019
description	union nut thread TR20 left ID ø 14mm L 24mm brass polished		

			
1			
Part No.	529791	Ref. No.	00947021 03207015 03207021
description	union nut thread TR20 left ID ø 14mm L 24mm chrome-plated		

			
1			
Part No.	526407	Ref. No.	00950021
description	union nut thread TR20 left L 21mm chrome-plated		

			
1			
Part No.	526406	Ref. No.	00950019
description	union nut thread TR20 left L 21mm WS 24 brass polished		

washers			
			
1			
Part No.	526393	Ref. No.	00955014
description	plain washer D1 ø 25mm D2 ø 20mm thickness 1.5mm aluminium for steam-/water-tap		

screw connections			
			
1			
Part No.	526408	Ref. No.	00954019
description	screw connection for steam-/water-tap T1: M18x1 T2: 3/8" L 9mm ø 26mm ID ø 8.5mm WS 24 brass polished		

			
1			
Part No.	526409	Ref. No.	00954014
description	screw connection for steam-/water-tap T1: M20x1 T2: 3/8" L 9mm ø 26mm ID ø 8mm WS 24 brass		

			
1			
Part No.	526410	Ref. No.	00954021
description	screw connection for steam-/water-tap T1: M20x1 T2: 3/8" L 9mm ø 26mm ID ø 8mm WS 24 chrome-plated		

miscellaneous			
			
1			
Part No.	526416	Ref. No.	01458014
description	ball for swing lever ø 16.4mm L 14mm thread M5		



water taps

water taps



1

Part No.	526381	Ref. No.	02907039
-----------------	--------	-----------------	----------

description	water tap complete brass polished blue/black		
--------------------	--	--	--



1

Part No.	526378	Ref. No.	01991039
-----------------	--------	-----------------	----------

description	water tap complete chrome-plated white/red		
--------------------	--	--	--



1

Part No.	526382	Ref. No.	00957034
-----------------	--------	-----------------	----------

description	water tap complete swing lever brass black		
--------------------	--	--	--



1

Part No.	526380	Ref. No.	00959034
-----------------	--------	-----------------	----------

description	water tap complete swing lever brass brown		
--------------------	--	--	--



1

Part No.	526375	Ref. No.	00959038
-----------------	--------	-----------------	----------

description	water tap complete swing lever brass polished		
--------------------	---	--	--



1

Part No.	526379	Ref. No.	00959039
-----------------	--------	-----------------	----------

description	water tap complete swing lever chrome-plated brown		
--------------------	--	--	--



steam/water pipes

steam pipes



1			
Part No.	529785	Ref. No.	00151039
description	steam pipe chrome-plated		



1			
Part No.	529786	Ref. No.	00151038
description	steam pipe copper		



1			
Part No.	526398	Ref. No.	00444011
description	steam pipe H 155mm ø 14.5mm		



1			
Part No.	529799	Ref. No.	02202039
description	steam pipe SS		



1			
Part No.	529800	Ref. No.	00439011
description	steam pipe SS		

nozzles for steam pipes



1			
Part No.	529801	Ref. No.	00448014
description	steam nozzle		



1			
Part No.	529788	Ref. No.	00088019 01400019
description	steam nozzle brass		



1			
Part No.	529787	Ref. No.	00088021 01400021
description	steam nozzle chrome-plated		

nozzles for water pipes

components



1			
Part No.	526415	Ref. No.	00442014
description	screw connection for flow regulator thread M21x1 L 29.5mm ø 23.5mm SS ID ø 16.1mm		



1			
Part No.	526414	Ref. No.	00423014
description	screw connection for flow regulator thread M22x1 L 16mm ø 23.5mm SS ID ø 20mm		

tap aerators



1			
Part No.	527966	Ref. No.	00424014
description	tap aerator D1 ø 18.8mm D2 ø 20.8mm H 12mm		

water pipes



1			
Part No.	526396	Ref. No.	02208038
description	water pipe thread M20x1 ø 23.5mm L 195mm		



1			
Part No.	526397	Ref. No.	02206039
description	water pipe thread M20x1 ø 23.5mm L 80mm		



1			
Part No.	526383	Ref. No.	02205034
description	water pipe thread M20x1 ø 23mm L 80mm		



accessories

gaskets



Part No.	526392	Ref. No.	00409035
description	flat gasket Viton ED ø 21mm ID ø 15mm thickness 2mm Qty 1 pcs		



Part No.	529805	Ref. No.	01893035 02265035 Viton
description	gasket PTFE D1 ø 20mm		

tube handles



Part No.	529627	Ref. No.	01964035 EK1001
description	tube handle ø 8mm L 30mm plastic		

union nuts



Part No.	529784	Ref. No.	01280019 01281019
description	union nut brass		



Part No.	529783	Ref. No.	01280021 01281021
description	union nut chrome-plated		



Part No.	526405	Ref. No.	00946014
description	union nut thread M20x1 ID ø 12.5mm L 21mm brass		



Part No.	529807	Ref. No.	00946019
description	union nut thread M20x1 with gasket ID ø 12.5mm L 21mm brass polished		

fine filters

fine filters



Part No.	529192	Ref. No.	00111035
description	fine filter fabric ID ø 12mm ø 18mm H 20mm		



Part No.	526395	Ref. No.	01341035
description	fine filter flat fabric ø 8.5mm H 2mm		

level glasses

level glasses

gaskets



Part No.	529449	Ref. No.	00119035
description	gasket D1 ø 15mm D2 ø 9mm H 8mm water level glass suitable for ELEKTRA equiv. no. 00119035		

pressure rings



Part No.	529450	Ref. No.	01380035
description	press ring		



Part No.	529453	Ref. No.	00142021
description	union screw chrome-plated		

housings







Part No.	529459	Ref. No.	00536031 01025031
description	base part for level glass round		





			
1			
Part No.	529462	Ref. No.	00899021
description	tap head for level glass round		

level glasses			
			
1			
Part No.	529461	Ref. No.	00544035
description	glass panel Lmm Wmm thickness 8mm ø 72.5mm		

level glasses (complete)				
				
1				
Part No.	529458	Ref. No.	00895039 01096039	
description	level glass complete			
spare parts for	529458			
	Part No.	529459	Ref. No. 00536031 01025031	
	base part for level glass round			
	Part No.	529460	Ref. No.	00543035
	O-ring EPDM thickness 5.34mm ID ø 59.69mm Qty 1 pcs			
	Part No.	529461	Ref. No.	00544035
	glass panel Lmm Wmm thickness 8mm ø 72.5mm			
	Part No.	529462	Ref. No.	00899021
	tap head for level glass round			

level glass pipes			
			
1			
Part No.	529448	Ref. No.	00141035
description	water level tube ø 9mm H 148mm		

protective plates			
			
1			
Part No.	529455	Ref. No.	00043021
description	protector		

			
1			
Part No.	529456	Ref. No.	00043019
description	protector		

screw connections			
			
1			
Part No.	529451	Ref. No.	00041021
description	union screw chrome-plated		

			
1			
Part No.	529452	Ref. No.	00041019
description	union screw varnished		

			
1			
Part No.	529454	Ref. No.	00142019
description	union screw varnished		

non-return valves			
complete			
			
1			
Part No.	529340	Ref. No.	00330034
description	non-return valve		



screw connections

double nipples



1

Part No.	526413	Ref. No.	01506014
description	double nipple T1: 1/4" T2: 3/8" int. ø 1 8.3mm L 5mm brass Qty 1 pcs		



1

Part No.	526412	Ref. No.	01288014
description	double nipple T1: 1/8" T2: 3/8" int. ø 1 8.5mm int. ø 2 5mm L 25.5mm brass Qty 1 pcs		

for coffee grinders

grinding burrs

grinding burrs straight

standard



1

Part No.	527700	Ref. No.	C0004M122
description	grinding burrs pair turn direction right D1 ø 64.5mm ID ø 38mm H 8.5mm tooth spacing 3mm hole ø 5mm bore ø 8.5mm mounting ø 48		

coffee beans containers

coffee beans containers



1

Part No.	527664	Ref. No.	C0007M113
description	coffee beans container ø 230mm H 265mm seat ø 67mm		

knobs

steam/water taps

steam/water taps



1

Part No.	529782	Ref. No.	00154035
description	knob ø 25mm shaft ø 9x9mm shaft flat square black		

knob dial plates



1

Part No.	111310	Ref. No.	01916030
description	bezel 0-1 yellow ELEKTRA		



1

Part No.	111312	Ref. No.	02903030
description	bezel 0-1-2 blue ELEKTRA		





1

Part No.	111311	Ref. No.	01908030
description	bezel 0-1-2 yellow ELEKTRA		



 <p>1</p>			
Part No.	526388	Ref. No.	02902030
description	disc for knob ø 33.8mm blue ELEKTRA		

 <p>1</p>			
Part No.	529814	Ref. No.	00953030
description	disc for knob ø 33.8mm ELEKTRA		

 <p>1</p>			
Part No.	531175	Ref. No.	03961030
description	disc steam ø 33.7mm ID ø 4.5mm thickness 1mm yellow for knob ELEKTRA		

<p>1</p>			
Part No.	531176	Ref. No.	03962030
description	disc water ø 33.7mm ID ø 4.5mm thickness 1mm yellow for knob ELEKTRA		

miscellaneous

 <p>1</p>			
Part No.	110205	Ref. No.	01965057
description	knob ø 27mm shaft ø 5x5mm		

 <p>1</p>			
Part No.	111315	Ref. No.	01965058
description	knob ø 28/48mm shaft ø 5x5mm brown H 22mm L 40mm		

 <p>1</p>			
Part No.	527259	Ref. No.	01965057
description	knob push-in ø 34/60mm shaft ø 5x5mm black H 21.4mm L 49mm		

handles and hand wheels

cylindrical handles

fixed

 <p>1</p>			
Part No.	110703	Ref. No.	00469035
description	cylindrical handle thread M10 ø 28mm L 87mm		

 <p>1</p>			
Part No.	529183	Ref. No.	00469035
description	cylindrical handle thread M10 ø 29mm L 86mm		

cone handles

 <p>1</p>			
Part No.	529810	Ref. No.	01900035
description	cone handle thread M8 ø 20mm L 58.5mm plastic black		

 <p>1</p>			
Part No.	111092	Ref. No.	02898035
description	cone handle thread M8 ø 25mm L 41mm black		

 <p>1</p>			
Part No.	111313	Ref. No.	01901035
description	cone handle thread M8 ø 25mm L 41mm plastic brown marbled		



star handles



1

Part No.	529813	Ref. No.	01898035
description	star handle shaft 7x7mm ø 58mm L 19mm brown thermoplastic		



1

Part No.	111309	Ref. No.	02899035
description	star handle shaft 7x7mm ø 62mm L 19mm black plastic		

levers

with handle



1

Part No.	111160	Ref. No.	00176039
description	lever		



1

Part No.	111161	Ref. No.	00176038
description	lever		

lever handles



1

Part No.	529810	Ref. No.	01900035
description	cone handle thread M8 ø 20mm L 58.5mm plastic black		

accessories

miscellaneous



1

Part No.	526421	Ref. No.	01902092
description	spring L 10mm ø 10mm		

gaskets

O-rings

EPDM

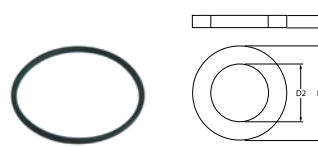

1

Part No.	510824	Ref. No.	01888035
description	O-ring EPDM thickness 1.78mm ID ø 20.35mm Qty 1 pcs		



1

Part No.	528333	Ref. No.	00113035
description	O-ring EPDM thickness 2.62mm ID ø 13.1mm Qty 1 pcs		

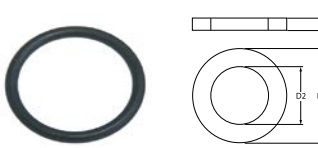

1

Part No.	510408	Ref. No.	00174035
description	O-ring EPDM thickness 5.34mm ID ø 47mm Qty 1 pcs		



1

Part No.	510409	Ref. No.	01917035
description	O-ring EPDM thickness 5.34mm ID ø 56.52mm Qty 1 pcs		



Part No.	529460	Ref. No.	00543035
description	O-ring EPDM thickness 5.34mm ID ø 59.69mm Qty 1 pcs		

Part No.	529190	Ref. No.	01228035
description	O-ring Viton thickness 2.62mm ID ø 31.42mm Qty 1 pcs		

silicone

Part No.	529187	Ref. No.	01386035
description	O-ring silicone thickness 2.62mm ID ø 13.1mm Qty 1 pcs		

Part No.	529186	Ref. No.	01204035
description	O-ring Viton thickness 3.53mm ID ø 47.63mm Qty 1 pcs		

Part No.	528182	Ref. No.	01168035
description	O-ring silicone thickness 3.53mm ID ø 66.27mm Qty 1 pcs		

sealing washers

fibre gaskets

Part No.	529349	Ref. No.	01172035
description	flat gasket FIBER ED ø 22mm ID ø 16.5mm thickness 2mm for thread 3/8" Qty 1 pcs		

Viton

Part No.	526394	Ref. No.	01994035
description	boiler gasket Viton thickness 3.53mm ID ø 129.8mm Qty 1 pcs		

Part No.	528171	Ref. No.	00499035
description	flat gasket fibre ED ø 55mm ID ø 42mm thickness 2mm Qty 1 pcs		

Part No.	532493	Ref. No.	00956035
description	O-ring Viton thickness 1.78mm ID ø 18.77mm Qty 1 pcs		

copper gaskets

DIN-7603-A

Part No.	529361	Ref. No.	00102035
description	flat gasket copper ED ø 18mm ID ø 13.5mm thickness 1.5mm for thread 1/4"		

Part No.	528647	Ref. No.	00144035
description	O-ring Viton thickness 2.62mm ID ø 15.08mm Qty 1 pcs		

DIN-7603-C

Part No.	526387	Ref. No.	01172035
description	flat gasket copper ED ø 21mm ID ø 17mm thickness 2mm		



springs

compression springs



1

Part No.	529803	Ref. No.	01912035
description	compression spring ϕ 10.9mm L 16mm wire gauge ϕ 1.8mm		



1

Part No.	529798	Ref. No.	01189035
description	compression spring ϕ 12.4mm L 36mm wire gauge ϕ 1.8mm		



1

Part No.	529191	Ref. No.	01242035
description	compression spring ϕ 20.3mm L 18mm wire gauge ϕ 1.8mm		



1

Part No.	529173	Ref. No.	00819014
description	compression spring ϕ 37mm L 93mm wire gauge ϕ 4.7mm		

manometers



1

Part No.	541718	Ref. No.	02904014
description	manometer double scale ϕ 60mm pressure range 0-2/0-16bar connection on the backside thread 1/8" blue/chrome		



1

Part No.	541264	Ref. No.	02218035
description	manometer double scale ϕ 60mm pressure range 0-2/0-16bar connection on the backside thread 1/8" chrome/chrome		



1

Part No.	526390	Ref. No.	00102035
description	gasket copper ED ϕ 18.7mm ID ϕ 13.2mm thickness 2.5mm Qty 1 pcs		

Viton gaskets



1

Part No.	526392	Ref. No.	00409035
description	flat gasket Viton ED ϕ 21mm ID ϕ 15mm thickness 2mm Qty 1 pcs		

special gaskets

group gaskets



1

Part No.	529170	Ref. No.	00098035
description	group gasket D1 ϕ 65mm thickness 2mm suitable for ELEKTRA equiv. no. 00098035		



1

Part No.	529174	Ref. No.	00172035
description	gasket		





1

Part No.	529175	Ref. No.	00173035
description	gasket ED ϕ 41mm ID ϕ 28mm H 6mm		



			
1			
Part No.	541719	Ref. No.	00985014
description	manometer double scale ø 60mm pressure range 0-2/0-16bar connection on the backside thread 1/8" white/chrome		

			
1			
Part No.	541255	Ref. No.	00985026
description	manometer double scale ø 60mm pressure range 0-2/0-16bar connection on the backside thread 1/8" white/gold		

			
1			
Part No.	541254	Ref. No.	00398035
description	manometer ø 41mm pressure range 0 up to 3bar connection pressure connection vertical marking 1.2-1.8 thread 1/8"		

			
1			
Part No.	541253	Ref. No.	00143035
description	manometer ø 42.3mm pressure range 0 up to 3bar connection vertical marking 1.6-2 thread 1/8"		

hoses

industrial hoses

hoses wire reinforced

			
1			
Part No.	520036	Ref. No.	00450035
description	drain hose ID ø 16mm ED ø 21mm L 30m wire reinforced		

			
1			
Part No.	520072	Ref. No.	00450035
description	drain hose ID ø 16mm ED ø 21mm L 5m wire reinforced		

fastening material

screws

countersunk screws

			
1			
Part No.	560300	Ref. No.	01206035
description	countersunk screw thread M5 L 16mm SS DIN 963/ISO 2009 Qty 1 pcs intake slotted head ø 9mm		

flat-headed bolts

			
1			
Part No.	560403	Ref. No.	00114035
description	flat-headed bolt thread M4 thread L 12mm brass Qty 1 pcs intake slotted head ø 7mm head thickness 2.5mm		

			
1			
Part No.	560406	Ref. No.	01983035
description	flat-headed bolt thread M4 thread L 16mm SS DIN 84 Qty 1 pcs intake slotted head ø 7mm head thickness 2.5mm WS 1.3		

oval head screws

			
1			
Part No.	560404	Ref. No.	01952015
description	oval head screw thread M4 thread L 8mm L 10mm head ø 10mm intake slotted Qty 1 pcs		

hexagonal screws

			
1			
Part No.	550682	Ref. No.	00126035
description	hexagonal screw thread M8 thread L 20mm SS WS 13 Qty 1 pcs DIN 933 / ISO 4017		



cylinder head bolts

DIN 912/ISO 4762



1

Part No.	560402	Ref. No.	00122035
description	cylinder head bolt thread M5 thread L 10mm L 15.5mm WS 4 SS Qty 1 pcs intake hexagonal DIN 912/ISO 4762		

nuts

hexagonal nuts

hexagonal nuts inch thread



1

Part No.	520484	Ref. No.	01290014
description	nut thread 3/8" H 5mm WS 21 brass Qty 1 pcs		

washers

washers

DIN 125A



1

Part No.	560405	Ref. No.	01291035
description	plain washer ID ø 17.3mm ED ø 30mm thickness 3mm SS Qty 1 pcs DIN 125A		



1

Part No.	511481	Ref. No.	01392035
description	plain washer ID ø 8.4mm ED ø 16mm thickness 1.6mm zinc-coated steel Qty 1 pcs DIN 125A for thread M8		

fasteners

retaining rings

DIN 471



1

Part No.	504519	Ref. No.	00044035
description	retaining ring shaft ø 17mm thickness 1mm SS DIN 471		

GASTROPARTS.COM

