



**GASTROPARTS**

# Dukers

**[EN]** Equipment

**[DE]** Geräte

**[ES]** Aparatos

**[FR]** Équipement

**[IT]** Attrezzature

**[PL]** Urządzenia

**[RU]** Оборудование

✉ [gastroparts@gastroparts.com](mailto:gastroparts@gastroparts.com)

☎ +48 56 657 00 66

📘 [fb.com/gastroparts.global](https://fb.com/gastroparts.global)

**GASTROPARTS.COM**





## thermostats

### refrigeration thermostats

#### miscellaneous producers



1

<b>Part No.</b>	390997	<b>Ref. No.</b>	DQWA0002 HSC350-18
<b>description</b>	thermostat probe ø 3.4mm probe Lmm capillary pipe 770mm type WPF11-L for fridge 1NO 230V 50/60Hz		



1

<b>Part No.</b>	390972	<b>Ref. No.</b>	DQWA0010 HSC360-37
<b>description</b>	thermostat temperature range°C probe ø 10mm probe L 24mm capillary pipe 660mm type WPF-45270 hole distance 55mm		

## switches and momentary switches

### rocker/momentary rocker switches

#### 28x10mm



1

<b>Part No.</b>	347804	<b>Ref. No.</b>	DQKC0000 GBC1001-21 GBC1002-22 GBC1003-22 HBC1002-22 HBC2003-22 HSC1002-22
<b>description</b>	rocker switch mounting measurements 28x10mm red 1NO 250V 15A 0-I connection male faston 6.3mm ambient temperature max. 85°C protection IP40		

#### ø20mm



1

<b>Part No.</b>	347803	<b>Ref. No.</b>	DQKA0000 GSC1100-04 HSC800-37
<b>description</b>	rocker switch mounting measurements 20mm red 1NO 250V 15A 0-I connection male faston 4.8mm ambient temperature max. 85°C protection IP40		

<b>Part No.</b>	347802	<b>Ref. No.</b>	GSC1336-05 GSC1336-5 GSC2336-05 GSC2336-5 HSC350-37 HSC360-31
<b>description</b>	rocker switch mounting ø 20mm red 1NO 250V 15A illuminated 0-I connection male faston 4.8mm ambient temperature max. 85°C protection IP40		

## lamps

### LED

#### LED bars

<b>Part No.</b>	357257	<b>Ref. No.</b>	DQLED007 HSC350DD-23
<b>description</b>	LED bar L 1100mm W 14.4mm H 7.5mm 24VDC white number of lamps 36 cable length 120mm		

<b>Part No.</b>	357256	<b>Ref. No.</b>	DQLED008 GSC1100G-27 HSC360G-21
<b>description</b>	LED bar L 1200mm W 14.4mm H 7.5mm 24VDC white number of lamps 42 cable length 120mm		

<b>Part No.</b>	357251	<b>Ref. No.</b>	DQLED066 HBC1002-29
<b>description</b>	LED bar L 400mm W 12mm H 12mm 24V blue number of lamps 30 cable length 280mm		



			
1			
<b>Part No.</b>	357255	<b>Ref. No.</b>	DQLED011 HSC350DD-30
<b>description</b>	LED bar L 400mm W 14.4mm H 7.5mm 24VDC white number of lamps 18 cable length 380mm		

			
1			
<b>Part No.</b>	357241	<b>Ref. No.</b>	DQLED067 HBC2003-29
<b>description</b>	LED bar L 600mm W 11.5mm H 12.5mm 24V number of lamps 42 cable length 285mm voltage DC		

			
1			
<b>Part No.</b>	357258	<b>Ref. No.</b>	GSC1100G-29
<b>description</b>	LED bar L 900mm W 14.4mm H 7.5mm 24VDC white number of lamps 30 cable length 120mm		

## fluorescent lamps

## fluorescent lamps

## G5

			
1			
<b>Part No.</b>	357156	<b>Ref. No.</b>	DQDA0009 GBC1001-31
<b>description</b>	fluorescent lamp socket G5 L 285mm 8W ø 16mm 230V T5/865 Qty 1 pcs		

			
1			
<b>Part No.</b>	357148	<b>Ref. No.</b>	DQDA0010 GBC1002-32 GBC1003-32
<b>description</b>	fluorescent lamp socket G5 L 547mm 14W ø 16mm 230V T5/865 Qty 1 pcs		

<b>G13</b>			
			
1			
<b>Part No.</b>	357145	<b>Ref. No.</b>	DQDA0012 GSC1336-22 GSC2336-22 HSC350-31
<b>description</b>	fluorescent lamp socket G13 L 438mm 15W ø 27mm 230V Qty 1 pcs light colour 865		

			
1			
<b>Part No.</b>	357146	<b>Ref. No.</b>	DQDA0007 GSC1336-18 GSC2336-18 HSC350-24 HSC360-26 HSC800-26
<b>description</b>	fluorescent lamp socket G13 L 895mm 30W ø 26mm 230V T8/765 Qty 1 pcs		

			
1			
<b>Part No.</b>	357147	<b>Ref. No.</b>	GSC1100-07
<b>description</b>	fluorescent lamp socket G13 L 895mm 30W ø 26mm 230V T8/765 Qty 1 pcs		

## accessories

## sockets

			
1			
<b>Part No.</b>	381169	<b>Ref. No.</b>	GSC1100-42 GSC1336-43 GSC2336-43 HSC800-30 SLJY2010
<b>description</b>	lamp holder socket G13 L 26.5mm W 24.5mm Qty 1 pcs for fluorescent lamps		

			
1			
<b>Part No.</b>	381447	<b>Ref. No.</b>	GBC1001-30 GBC1002-31 GBC1003-31 SLZA3000
<b>description</b>	lamp socket socket G13 L 33mm W 10mm H 28mm		



			
1			
<b>Part No.</b>	381413	<b>Ref. No.</b>	GSC1100-08 HSC350-28 HSC360-28 SLZA2000
<b>description</b>	lamp socket socket G13 L 37.5mm W 28.5mm Qty 1 pcs for fluorescent lamps		

starter holders

			
1			
<b>Part No.</b>	381170	<b>Ref. No.</b>	GBC1001-27 GBC1002-28 GBC1003-28 GSC1100-44 GSC1336-21 GSC2336-21 HSC350-34 HSC360-08 HSC800-35 SLZA1000
<b>description</b>	starter holder L 32mm W 24mm housing ø 23mm Qty 1 pcs		

starter

			
1			
<b>Part No.</b>	380464	<b>Ref. No.</b>	DQDF0000 GBC1001-26 GBC1002-27 GBC1003-27 GSC1100-45 GSC1336-20 GSC2336-20 HSC350-33 HSC360-09
<b>description</b>	starter 4-65W		

ballasts

			
1			
<b>Part No.</b>	403192	<b>Ref. No.</b>	DQZB0005 GBC1002-18 GBC1003-18
<b>description</b>	electrical ballast 15W 220-240V connection screw clamp for fluorescent lamps type JF-1595M Qty 1 pcs		

			
1			
<b>Part No.</b>	403190	<b>Ref. No.</b>	DQZA0027 GSC1100-35 GSC1336-35 HSC800-31
<b>description</b>	electrical ballast 30W 220-240V connection screw clamp for fluorescent lamps type JF-3095W Qty 1 pcs		

			
1			
<b>Part No.</b>	358134	<b>Ref. No.</b>	DQZA0024 GSC1336-23 GSC2336-23 HSC360-06
<b>description</b>	electrical ballast 76W 230V connection screw clamp for fluorescent lamps type JF-1595W Qty 1 pcs		

			
1			
<b>Part No.</b>	403191	<b>Ref. No.</b>	DQZB0029 GBC1001-17
<b>description</b>	electrical ballast 9W 220V connection screw clamp for fluorescent lamps type JF-995M Qty 1 pcs		



covers

			
1			
<b>Part No.</b>	699314	<b>Ref. No.</b>	GBC1001-32 SLZV0017
<b>description</b>	cover L 510mm W 30mm H 30mm		

			
1			
<b>Part No.</b>	694873	<b>Ref. No.</b>	HSC350-40 SLSE2008
<b>description</b>	cover L 590mm W 280mm H 1mm		

			
1			
<b>Part No.</b>	699312	<b>Ref. No.</b>	GBC1002-33 GBC1003-33 SLZV0018
<b>description</b>	cover L 810mm W 30mm H 30mm transparent		



			
1			
<b>Part No.</b>	694874	<b>Ref. No.</b>	GSC1100-03 GSC1100-05 HSC350-38 SLZQ0037
<b>description</b>	cover set mounting pos. left/right W 82mm H 280mm D 34		
<b>spare parts for</b>	694874		
	<b>Part No.</b>	692393	<b>Ref. No.</b> —
<b>description</b>	bezel for cover mounting pos. right/left W 82mm H 280mm D 34mm plastic Qty 1 pcs		
	<b>Part No.</b>	692394	<b>Ref. No.</b> —
<b>description</b>	bezel for cover mounting pos. left W 82mm H 280mm D 34mm plastic Qty 1 pcs		

			
1			
<b>Part No.</b>	694872	<b>Ref. No.</b>	HSC350-36 SLJV2040
<b>description</b>	cover support L 610mm W 20mm H 55mm mounting pos. lower		

			
1			
<b>Part No.</b>	694871	<b>Ref. No.</b>	HSC350-41 SLJV2041
<b>description</b>	cover support L 610mm W 20mm H 55mm mounting pos. upper		

			
1			
<b>Part No.</b>	699307	<b>Ref. No.</b>	HSC360-24 SLZE0061
<b>description</b>	end cap L 60mm W 40mm H 10mm for lamp		

			
1			
<b>Part No.</b>	694870	<b>Ref. No.</b>	HSC350-23 SLJY2016
<b>description</b>	housing L 131.5mm W 45mm H 40mm		

## relays

## power relays

## with bracket mounting

			
1			
<b>Part No.</b>	380867	<b>Ref. No.</b>	DQWBZJ02 HSC800-22
<b>description</b>	relay SHANGFANG 12VDC 30A 1NO connection male faston 6.3mm screw mounting at 250V 30A manuf. no. 855AW-1A-C1		

## transformers

## encapsulated transformers

<b>PMA</b>			
			
1			
<b>Part No.</b>	379054	<b>Ref. No.</b>	HSC800-23
<b>description</b>	transformer primary 230VAC secondary 12VAC 3VA secondary 0.25A H 40mm L 45mm W 50mm connection screw 50/60Hz type 153/M		

## miscellaneous

			
1			
<b>Part No.</b>	403660	<b>Ref. No.</b>	DQLED069 HBC1002-18 HBC2003-18
<b>description</b>	transformer primary 100-240V secondary 24VDC 20VA secondary 0.84A		

			
1			
<b>Part No.</b>	403867	<b>Ref. No.</b>	DQLED042 DQLED055 GSC1100G-31 GSC1100G-32 HSC350DD-32 HSC350DD-33 HSC360G-06
<b>description</b>	transformer primary 100-240V secondary 24VDC secondary 0.42A H 25mm L 95mm W 40mm		



electronic controllers

SHANGFANG

refrigeration controllers

built-in version



1

<b>Part No.</b>	379799 <sup>1</sup>	<b>Ref. No.</b>	DQWBZX02 GSC1100-22 GSC1336-11 GSC2336-11 HSC800-52
<b>description</b>	electronic controller SHANGFANG type SF-104S-2 mounting measurements 71x29mm 12V voltage AC NTC relay outputs 2 12VDC 12VDC NTC front measurements 77x35mm built-in depth 40mm protection IP54 accuracy 1% built-in version alarm without accessories defr. funct. yes -45 up to +45°C display 3 digits		
<b>spare parts for</b>	379799		
	<b>Part No.</b>	379054	<b>Ref. No.</b> HSC800-23
	transformer primary 230VAC secondary 12VAC 3VA secondary 0.25A H 40mm L 45mm W 50mm connection screw 50/60Hz type 153/M		
	<b>Part No.</b>	380867	<b>Ref. No.</b> DQWBZJ02 HSC800-22
	relay SHANGFANG 12VDC 30A 1NO connection male faston 6.3mm screw mounting at 250V 30A manuf. no. 855AW-1A-C1		
	<b>Part No.</b>	381318	<b>Ref. No.</b> —
	temperature probe NTC cable silicone cable colours white cable length 3m probe -40 up to +110°C cable -50 up to +180°C probe ø7x25mm coded plug		
	<b>Part No.</b>	381319	<b>Ref. No.</b> —
	temperature probe NTC cable silicone cable colours black cable length 3m evaporator probe -40 up to +110°C cable -50 up to +180°C probe ø7x25mm coded plug		
<b>accessories for</b>	379799		
	<b>Part No.</b>	379054	<b>Ref. No.</b> HSC800-23
	transformer primary 230VAC secondary 12VAC 3VA secondary 0.25A H 40mm L 45mm W 50mm connection screw 50/60Hz type 153/M		
	<b>Part No.</b>	380867	<b>Ref. No.</b> DQWBZJ02 HSC800-22
	relay SHANGFANG 12VDC 30A 1NO connection male faston 6.3mm screw mounting at 250V 30A manuf. no. 855AW-1A-C1		
	<b>Part No.</b>	381318	<b>Ref. No.</b> —
	temperature probe NTC cable silicone cable colours white cable length 3m probe -40 up to +110°C cable -50 up to +180°C probe ø7x25mm coded plug		
	<b>Part No.</b>	381319	<b>Ref. No.</b> —
	temperature probe NTC cable silicone cable colours black cable length 3m evaporator probe -40 up to +110°C cable -50 up to +180°C probe ø7x25mm coded plug		

<sup>1</sup>without relay, cable harness, probe and transformer

built-in version 2-piece









1

<b>Part No.</b>	378531	<b>Ref. No.</b>	HBC1002-19 HBC2003-19
<b>description</b>	electronic controller SHANGFANG type SF-101S mounting measurements 71x29mm 230V voltage AC NTC relay outputs 1 NO-30A NTC Comp front measurements 77x35mm built-in depth 40mm protection IP54 accuracy 1% built-in version alarm incl. relay, cable harness, probe and transformer defr. funct. yes -45 up to +45°C display 3 digits		



1

<b>Part No.</b>	379849 <sup>1</sup>	<b>Ref. No.</b>	DQWB0005 GBC1001-18 GBC1002-19 GBC1003-19
<b>description</b>	electronic controller SHANGFANG type SF-101S mounting measurements 71x29mm 230V voltage AC NTC relay outputs 1 NO-30A NTC Comp front measurements 77x35mm built-in depth 40mm protection IP54 accuracy 1% built-in version alarm incl. relay, cable harness, probe and transformer defr. funct. yes -45 up to +45°C display 3 digits		
<b>spare parts for</b>	379849		
	<b>Part No.</b>	379054	<b>Ref. No.</b> HSC800-23
	transformer primary 230VAC secondary 12VAC 3VA secondary 0.25A H 40mm L 45mm W 50mm connection screw 50/60Hz type 153/M		
	<b>Part No.</b>	380867	<b>Ref. No.</b> DQWBZJ02 HSC800-22
	relay SHANGFANG 12VDC 30A 1NO connection male faston 6.3mm screw mounting at 250V 30A manuf. no. 855AW-1A-C1		
	<b>Part No.</b>	381318	<b>Ref. No.</b> —
	temperature probe NTC cable silicone cable colours white cable length 3m probe -40 up to +110°C cable -50 up to +180°C probe ø7x25mm coded plug		
	<b>Part No.</b>	381319	<b>Ref. No.</b> —
	temperature probe NTC cable silicone cable colours black cable length 3m evaporator probe -40 up to +110°C cable -50 up to +180°C probe ø7x25mm coded plug		
<b>accessories for</b>	379849		
	<b>Part No.</b>	379054	<b>Ref. No.</b> HSC800-23
	transformer primary 230VAC secondary 12VAC 3VA secondary 0.25A H 40mm L 45mm W 50mm connection screw 50/60Hz type 153/M		
	<b>Part No.</b>	380867	<b>Ref. No.</b> DQWBZJ02 HSC800-22
	relay SHANGFANG 12VDC 30A 1NO connection male faston 6.3mm screw mounting at 250V 30A manuf. no. 855AW-1A-C1		
	<b>Part No.</b>	381318	<b>Ref. No.</b> —
	temperature probe NTC cable silicone cable colours white cable length 3m probe -40 up to +110°C cable -50 up to +180°C probe ø7x25mm coded plug		

<sup>1</sup>incl. relay, cable harness, probe and transformer

Table continues overleaf



accessories for	379849			
	<b>Part No.</b>	381319	Ref. No.	—
	temperature probe NTC cable silicone cable colours black cable length 3m evaporator probe -40 up to +110°C cable -50 up to +180°C probe ø7x25mm coded plug			



<b>Part No.</b>	403074 <sup>1</sup>	<b>Ref. No.</b>	DQWB0002 GSC1100-25 GSC1336-12 GSC2336-12
-----------------	---------------------	-----------------	--

<b>description</b>	electronic controller SHANGFANG type SF-104S-2 mounting measurements 71x29mm 230V voltage AC NTC relay outputs 2 NO-30A NO-30A NTC NTC front measurements 77x35mm built-in depth 38mm protection IP54 accuracy 1% built-in version alarm incl. relay, cable harness, probe and transformer defr. funct. yes -45 up to +45°C display 2½ digit		
--------------------	--	--	--

spare parts for	403074		
-----------------	--------	--	--

	<b>Part No.</b>	379054	Ref. No.	HSC800-23
	transformer primary 230VAC secondary 12VAC 3VA secondary 0.25A H 40mm L 45mm W 50mm connection screw 50/60Hz type 153/M			

	<b>Part No.</b>	380867	Ref. No.	DQWBZJ02 HSC800-22
	relay SHANGFANG 12VDC 30A 1NO connection male faston 6.3mm screw mounting at 250V 30A manuf. no. 855AW-1A-C1			

	<b>Part No.</b>	381318	Ref. No.	—
	temperature probe NTC cable silicone cable colours white cable length 3m probe -40 up to +110°C cable -50 up to +180°C probe ø7x25mm coded plug			

	<b>Part No.</b>	381319	Ref. No.	—
	temperature probe NTC cable silicone cable colours black cable length 3m evaporator probe -40 up to +110°C cable -50 up to +180°C probe ø7x25mm coded plug			

accessories for	403074		
-----------------	--------	--	--

	<b>Part No.</b>	379054	Ref. No.	HSC800-23
	transformer primary 230VAC secondary 12VAC 3VA secondary 0.25A H 40mm L 45mm W 50mm connection screw 50/60Hz type 153/M			

	<b>Part No.</b>	380867	Ref. No.	DQWBZJ02 HSC800-22
	relay SHANGFANG 12VDC 30A 1NO connection male faston 6.3mm screw mounting at 250V 30A manuf. no. 855AW-1A-C1			

	<b>Part No.</b>	381318	Ref. No.	—
	temperature probe NTC cable silicone cable colours white cable length 3m probe -40 up to +110°C cable -50 up to +180°C probe ø7x25mm coded plug			

	<b>Part No.</b>	381319	Ref. No.	—
	temperature probe NTC cable silicone cable colours black cable length 3m evaporator probe -40 up to +110°C cable -50 up to +180°C probe ø7x25mm coded plug			

<sup>1</sup>incl. relay, cable harness, probe and transformer

## accessories

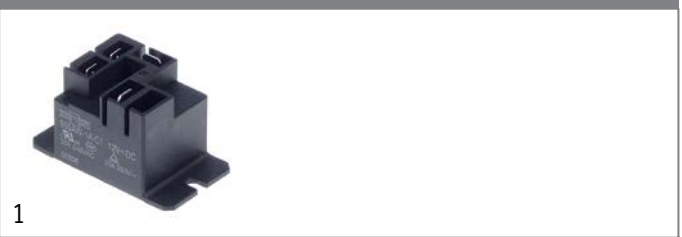

<b>Part No.</b>	380867	<b>Ref. No.</b>	DQWBZJ02 HSC800-22
<b>description</b>	relay SHANGFANG 12VDC 30A 1NO connection male faston 6.3mm screw mounting at 250V 30A manuf. no. 855AW-1A-C1		



<b>Part No.</b>	379054	<b>Ref. No.</b>	HSC800-23
<b>description</b>	transformer primary 230VAC secondary 12VAC 3VA secondary 0.25A H 40mm L 45mm W 50mm connection screw 50/60Hz type 153/M		

## miscellaneous

## refrigeration controllers

	<b>Part No.</b>	379848	<b>Ref. No.</b>	GBC1001-19 GBC1002-20 GBC1003-20
	electronic controller ZHONGSHAN SHANGFANG INSTRUMENT type SF-101 mounting measurements 71x29mm 12V display 3 digits relay outputs 1			



compressors

ACC/ZEL

R600A

LBP monophase

Lower evaporation temperature below -20°C



1

<b>Part No.</b>	605141	<b>Ref. No.</b>	DQYD0015 GBC1002-15 GBC1003-15 GSC2336-33 HBC1002-15
<b>description</b>	compressor coolant R600a type HPY12AAa 220-240V 50Hz LBP 8.8kg 1/5HP cylinder capacity 12cm <sup>3</sup> RSIR H 200mmWWWWWWWWW		



1

<b>Part No.</b>	605142	<b>Ref. No.</b>	DQYD0014 GBC1001-14
<b>description</b>	compressor coolant R600a type HVM86AA 220-240V 50Hz LBP fully hermetic 7.83kg 1/7HP cylinder capacity 8.6cm <sup>3</sup> RSIR H 174mmWWWW		

miscellaneous

R134A



1

<b>Part No.</b>	605240	<b>Ref. No.</b>	HSC800-07
<b>description</b>	compressor HuaGuang coolant R134a type AN150ML 220-240V 50Hz LBP 10.5kg 1/2HP cylinder capacity 15.1cm <sup>3</sup> CSIR H 180mmWWWWWWWWW		



1

<b>Part No.</b>	605239	<b>Ref. No.</b>	DQYA0009 HBC2003-15
<b>description</b>	compressor HuaGuang coolant R134a type ANA90 220-240V 50Hz 10.5kgHP power input 255W cylinder capacitycm <sup>3</sup> H 180mmWWWWWWWWW		



1

<b>Part No.</b>	605245	<b>Ref. No.</b>	DQYA0014 HSC350-07 HSC350-7 HSC360-11
<b>description</b>	compressor HuaGuang coolant R134a type ATA72XL 220-240V 50/60Hz 7.2kg 1/5HP cylinder capacity 7cm <sup>3</sup> H 160mmWWWWWWWWW		





			
1			
<b>Part No.</b>	605140	<b>Ref. No.</b>	DQYA0087 GSC1100-28 GSC1336-33
<b>description</b>	compressor KONOR type GQR90AA coolant R134a 220-240V 50Hz 10.1kg 1/4HP cylinder capacity 9.1cm <sup>3</sup> RSIR H 186mmWWWWWWW		

## R290A

			
1			
<b>Part No.</b>	605271	<b>Ref. No.</b>	GSC1100G-08
<b>description</b>	compressor HuaGuang coolant R290 type FN90M 220-240V 50Hz LBP 11kg 1HP CSIR		

## R600A

			
1			
<b>Part No.</b>	605272	<b>Ref. No.</b>	DQYD0009 HSC350DD-07 HSC360G-08
<b>description</b>	compressor HuaGuang coolant R600 type ETA110 220-240V 50Hz LBP 8kg 1/4HP RSIR		

## fans

## axial fans

## import

			
1			
<b>Part No.</b>	601787 <sup>1</sup>	<b>Ref. No.</b>	DQFA1000 DQFD1000 DQFD1001 GBC1001-07 GBC1001-35 GBC1002-36 GBC1003-36 GSC1100-17 GSC1336-15 GSC2336-15 HBC1002-33 HSC350-42 HSC360-30 HSC800-44
<b>description</b>	axial fan L 119mm W 119mm H 38mm 230VAC 50/60Hz 22/38.4W bearing slide bearing manuf. no. HT-A12038S220 connection plug cable length 300mm HUI TONG fan wheel ø 110mm input current 0.1/0.16A housing aluminium		

<sup>1</sup>with slide bearings

			
1			
<b>Part No.</b>	602136	<b>Ref. No.</b>	DQFD2003 HBC2003-33
<b>description</b>	axial fan L 119mm W 119mm H 38mm 230VAC 50/60Hz 22/38.4W bearing slide bearing manuf. no. HT-A12038S220 connection with cable 500mm cable length 300mm HUI TONG fan wheel ø 110mm input current 0.1/0.16A housing aluminium		



accessories			
fan guards			
1			
<b>Part No.</b>	691104	<b>Ref. No.</b>	GBC1001-36 GBC1002-37 GBC1003-37 GSC1336-13 GSC2336-13 HBC1002-34 HBC2003-34 HSC350-43 WJFZ0007
<b>description</b>	guard ø 115mm mounting distance 105mm for axial fan 119mm		

1			
<b>Part No.</b>	601835	<b>Ref. No.</b>	DQJB2013 GSC1100-26 HL-YJF10
<b>description</b>	fan 220V 35/5W 50/60Hz L 82mm W 82mm connection spate terminal M4 cable length 1100mm		
<b>spare parts for</b>	601835		
	<b>Part No.</b>	602184	<b>Ref. No.</b> —
	fixing plate suitable for fanwheel ED ø 33mm shaft ø 6 mounting distance 17mm		

refrigeration fans			
refrigeration motors universal			
miscellaneous			
1			
<b>Part No.</b>	602164	<b>Ref. No.</b>	GSC1100G-07
<b>description</b>	fan motor 10W 220-240V 50-60Hz L2 65mm L3 81mm W 82mm cable length 1200mm 1300/1500rpm HL-YJF10		

accessories universal			
1			
<b>Part No.</b>	699309	<b>Ref. No.</b>	HSC360-35 WJFZ0008
<b>description</b>	guard ø 194mm hole distance 208mm		

cooling motors (complete)			
1			
<b>Part No.</b>	601836	<b>Ref. No.</b>	DQJB2004 GBC1002-07 GBC1003-07 HBC1002-07 HBC2003-07 HSC800-19
<b>description</b>	fan 220V 25/3W 50/60Hz fan wheel ø 172mm L 82mm W 82mm connection spate terminal M4 cable length 1000mm		

electric accessories			
cables			
power supply cables			
1			
<b>Part No.</b>	551217	<b>Ref. No.</b>	DQXA6002 GBC1001-15 GBC1002-16 GBC1003-16 GSC1100-34 GSC1336-30 GSC2336-30 HBC1002-16 HBC2003-16 HSC350-05 HSC360-05
<b>description</b>	power lead CEE7/7 type E+F 3-pole contacts P+N+E 0.75mm² max. 16A 2.2m with strain relief 16A Qty 1 pcs white		



## connection cables

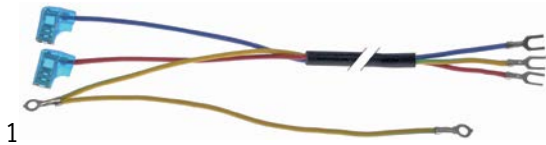

1

<b>Part No.</b>	699304	<b>Ref. No.</b>	DQXB9019 GBC1001-20 GBC1002-21 GBC1003-21 HBC1002-21 HBC2003-21
<b>description</b>	connection cable L 360mm 3-pole		

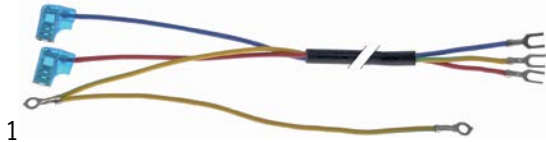

1

<b>Part No.</b>	699305	<b>Ref. No.</b>	DQXB2003 GSC1336-31 GSC2336-31 HSC350-03 HSC360-03
<b>description</b>	connection cable L 650mm 3-pole		

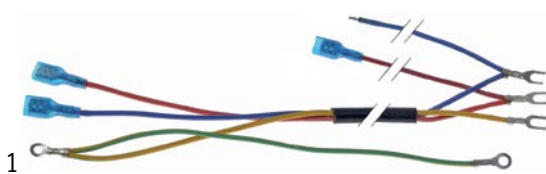

1

<b>Part No.</b>	699306	<b>Ref. No.</b>	DQXB4003 HSC800-02
<b>description</b>	connection cable L 665mm 3-pole		

## terminal boxes



1

<b>Part No.</b>	551216	<b>Ref. No.</b>	GBC1001-16 GBC1002-17 GBC1003-17 GSC2336-35 HBC1002-17 HBC2003-17 HSC350-06 HSC360-10 HSC800-21 SLZB3001
<b>description</b>	terminal box 4-pole L 90mm W 52mm H 33mm with strain relief 250V 1mm <sup>2</sup> Qty 1 pcs		

## equipment-specific units

## for fridges

## drain systems

## drain valves



1

<b>Part No.</b>	692441	<b>Ref. No.</b>	GSC1100-48
<b>description</b>	drain fitting L 45mm plastic H 38mm W 28mm hose ø 10mm Qty 1 pcs		

## spare parts and accessories



1

<b>Part No.</b>	694868	<b>Ref. No.</b>	HSC350-11
<b>description</b>	bracket for dryer L 40mm W 30mm H 31mm Qty 1 pcs		



1

<b>Part No.</b>	694869	<b>Ref. No.</b>	HSC350-17
<b>description</b>	cover L 153mm W 57mm H 110mm plastic Qty 1 pcs mounting distance 125mm		



1

<b>Part No.</b>	694967	<b>Ref. No.</b>	HSC360G-22 SLCX0002
<b>description</b>	cover L 51mm W 44mm H 12mm plastic mounting distance 30mm		



1 

<b>Part No.</b>	698878	<b>Ref. No.</b>	HBC1002-47 HBC2003-46 WJQZ9000 WJQZ9001
<b>description</b>	guide counterweight for sliding door L 248mm W 20mm H 10mm		

1 

<b>Part No.</b>	694594	<b>Ref. No.</b>	GSC1336-03 GSC2336-03
<b>description</b>	cover for lighting W 615mm H 180mm plate thickness max. 1mm plexiglas white Qty 1 pcs		

1 

<b>Part No.</b>	698890	<b>Ref. No.</b>	HBC2003-25 PTBP9N88
<b>description</b>	cover L 1350mm W 65mm H 52mm Qty 1 pcs		

1 

<b>Part No.</b>	694969	<b>Ref. No.</b>	GSC1100G-28
<b>description</b>	cover L 1420mm W 127mm H 30mm		

housing and bezels

covers

1 

<b>Part No.</b>	694596	<b>Ref. No.</b>	GSC1336-04 GSC1336-4 GSC2336-04 GSC2336-4
<b>description</b>	bezel for lighting L 185mm W 72mm H 15mm mounting pos. left Qty 1 pcs		

1 

<b>Part No.</b>	694595	<b>Ref. No.</b>	GSC1336-02 GSC2336-02
<b>description</b>	bezel for lighting L 185mm W 72mm H 15mm mounting pos. right Qty 1 pcs		

1 

<b>Part No.</b>	698891	<b>Ref. No.</b>	HBC1002-25 PTBP9N76
<b>description</b>	cover for compressor L 900mm W 65mm H 52mm Qty 1 pcs		

1 

<b>Part No.</b>	698889	<b>Ref. No.</b>	HBC800-29
<b>description</b>	cover for lamp transparent L 1500mm W 56mm H 20mm plastic		

lids

1 

<b>Part No.</b>	698886	<b>Ref. No.</b>	HSC800-16
<b>description</b>	cover for compressor white L 1005mm W 325mm H 45mm Qty 1 pcs		

handles

1 

<b>Part No.</b>	692390	<b>Ref. No.</b>	GSC1100-12 GSC1336-45 GSC2336-45 LCCG0005
<b>description</b>	handle rod for door L 380mm W 40mm aluminium Qty 1 pcs		

miscellaneous

1 

<b>Part No.</b>	694859	<b>Ref. No.</b>	HSC800-40
<b>description</b>	cover for lighting L 970mm W 280mm plexiglas thickness 1mm		

1 

<b>Part No.</b>	692392	<b>Ref. No.</b>	GSC1100-02 SLSE4005
<b>description</b>	cover for lighting W 1170mm H 280mm thickness 1mm plastic Qty 1 pcs		

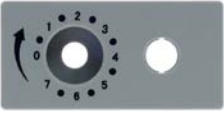

1 

<b>Part No.</b>	694875	<b>Ref. No.</b>	HSC350-19 SLZE0026
<b>description</b>	cover for thermostat		

1 

<b>Part No.</b>	692391	<b>Ref. No.</b>	GSC1336-24 GSC2336-24 HSC350-39 HSC800-39 SLZE0027
<b>description</b>	housing for bulb socket L 150mm W 40mm H 20mm plastic Qty 1 pcs		

doors  
doors

1 

<b>Part No.</b>	698989	<b>Ref. No.</b>	BLGM2B12 HSC350-46
<b>description</b>	glass door L 1350mm W 620mm		

1 

<b>Part No.</b>	699381	<b>Ref. No.</b>	BLGM4010 GSC1100-15
<b>description</b>	glass door left W 600mm H 1330mm D 40mm		

1 

<b>Part No.</b>	699382	<b>Ref. No.</b>	BLGM4011 GSC1100-16
<b>description</b>	glass door right W 600mm H 1330mm D 40mm		



1	<b>Part No.</b>	699375	<b>Ref. No.</b>	BLGM4160 HSC800-51
	<b>description</b>	glass door W 460mm H 1230mm mounting pos. left D 30mm		



1	<b>Part No.</b>	699377	<b>Ref. No.</b>	GSC1336-07 GSC2336-07
	<b>description</b>	glass door W 620mm H 1380mm with handle D 40mm		



1	<b>Part No.</b>	699376	<b>Ref. No.</b>	BLGM4161 HSC800-49
	<b>description</b>	glass door W 460mm H 1230mm mounting pos. right D 30mm		



1	<b>Part No.</b>	699374	<b>Ref. No.</b>	BLPM2033 HSC360-40
	<b>description</b>	glass door W 620mm H 1600mm D 40mm		



<b>Part No.</b>	699494	<b>Ref. No.</b>	BLGM4024 HSC350DD-47
<b>description</b>	glass door W 620mm H 680mm D 38mm mounting pos. upper		
<b>spare parts for</b>	699494		
	<b>Part No.</b>	902465	<b>Ref. No.</b> HSC350DD-46 HSC350DD-49 SLJP2015
refrigeration gasket profile 9161 W 590mm L 650mm plug size			



<b>Part No.</b>	699493	<b>Ref. No.</b>	BLGM4025 HSC350DD-51
<b>description</b>	glass door with lock W 620mm H 680mm D 38mm mounting pos. lower		
<b>spare parts for</b>	699493		
	<b>Part No.</b>	902465	<b>Ref. No.</b> HSC350DD-46 HSC350DD-49 SLJP2015
refrigeration gasket profile 9161 W 590mm L 650mm plug size			

## miscellaneous



<b>Part No.</b>	701431	<b>Ref. No.</b>	HSC360-22 WJLD0000
<b>description</b>	bracket for glass door L 54mm W 42mm H 75mm hole $\varnothing$ 7x12mm Qty 1 pcs		

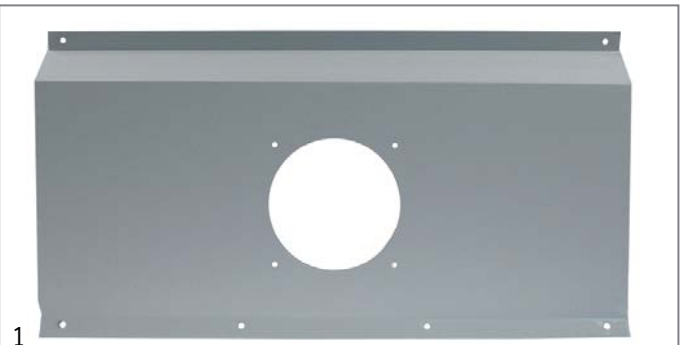

<b>Part No.</b>	694867	<b>Ref. No.</b>	HSC350-29 PTBP2020
<b>description</b>	cover for evaporator L 525mm W 280mm H 53mm plate Qty 1 pcs		

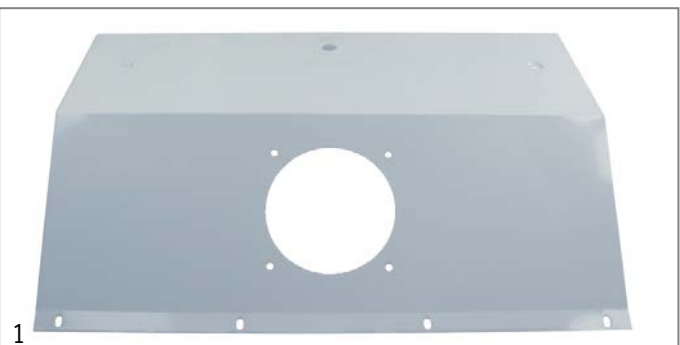



<b>Part No.</b>	694597	<b>Ref. No.</b>	GSC1336-14 GSC2336-14
<b>description</b>	cover for evaporator L 525mm W 345mm H 115mm plate Qty 1 pcs		



<b>Part No.</b>	692424	<b>Ref. No.</b>	GSC1336-19 GSC2336-19 HSC350-25 SLZV0007
<b>description</b>	cover for lighting mounting pos. inner L 1263mm W 56mm H 20mm plastic Qty 1 pcs		



			
1			
<b>Part No.</b>	698888	<b>Ref. No.</b>	HBC1002-30 HBC2003-30 SLZV0019
<b>description</b>	cover transparent for lamp L 810mm W 40mm H 30mm Qty 1 pcs		

			
1			
<b>Part No.</b>	692426	<b>Ref. No.</b>	GSC1336-38 GSC2336-38 HSC350-26 LCCJ2029
<b>description</b>	guide for fridge L 1145mm W 26mm H 4.5mm Qty 1 pcs		

			
1			
<b>Part No.</b>	698877	<b>Ref. No.</b>	HSC800-28 LCCK0001
<b>description</b>	shelf support L 26.5mm W 8.5mm H 40mm aluminium		

for display coolers

housing and bezels

fascias

			
1			
<b>Part No.</b>	692733	<b>Ref. No.</b>	HSC360-27 SLJX2014
<b>description</b>	cover for lamp W 55mm H 20mm L 1040mm		

housings

			
1			
<b>Part No.</b>	699298	<b>Ref. No.</b>	HSC800-38
<b>description</b>	side panel mounting pos. upper for lamp W 40mm H 80mm L 280mm plastic		

miscellaneous

			
1			
<b>Part No.</b>	699310	<b>Ref. No.</b>	HSC800-47
<b>description</b>	cover L 500mm W 40mm thickness 0.5mm		

			
1			
<b>Part No.</b>	699315	<b>Ref. No.</b>	HBC1002-39 HBC2003-39 SLZE0042
<b>description</b>	fixing plate for evaporator L 55mm W 27mm H 6mm		

doors

			
1			
<b>Part No.</b>	699379	<b>Ref. No.</b>	GBC1002-49 GBC1003-49
<b>description</b>	glass door W 440mm H 770mm D 25mm		

			
1			
<b>Part No.</b>	698973	<b>Ref. No.</b>	BLGM9S01 HBC1002-44
<b>description</b>	glass door W 440mm H 770mm mounting pos. right		





			
1			
<b>Part No.</b>	699378	<b>Ref. No.</b>	GBC1002-47 GBC1003-47
<b>description</b>	glass door W 440mm H 770mm with catch D 25mm		

			
1			
<b>Part No.</b>	698969	<b>Ref. No.</b>	BLGM9S57 HBC2003-48
<b>description</b>	glass door W 450mm H 770mm mounting pos. left		

			
1			
<b>Part No.</b>	698972	<b>Ref. No.</b>	BLGM9S00 HBC1002-45
<b>description</b>	glass door W 440mm H 770mm with lock mounting pos. left		
<b>accessories for</b>	698972		
	<b>Part No.</b>	902210	<b>Ref. No.</b> HBC2003-52 JNMA0000
gasket L 930mm Qty 1 dimensions 5x6mm			

			
1			
<b>Part No.</b>	698970	<b>Ref. No.</b>	BLGM9S5M GBC1003-48 HBC2003-49
<b>description</b>	glass door W 450mm H 770mm with lock mounting pos. centre		

			
1			
<b>Part No.</b>	698971	<b>Ref. No.</b>	BLGM9S52 HBC2003-50
<b>description</b>	glass door W 440mm H 770mm with lock mounting pos. right		

			
1			
<b>Part No.</b>	699380	<b>Ref. No.</b>	GBC1001-44
<b>description</b>	glass door W 600mm H 800mm D 30mm		

## door mechanics

## miscellaneous

			
1			
<b>Part No.</b>	694928	<b>Ref. No.</b>	HBC1002-48 HBC2003-44 WJXC0000
<b>description</b>	door magnet L 46mm W 16mm H 14.5mm		



 <p>1</p>			
<b>Part No.</b>	694929	<b>Ref. No.</b>	HBC1002-49 HBC2003-45 WJCXG000
<b>description</b>	plate for magnet L 45mm W 12mm H 1.5mm mounting distance 32mm		

 <p>1</p>			
<b>Part No.</b>	692423	<b>Ref. No.</b>	GSC1336-10 GSC2336-10 HSC360-41 WJSB0000
<b>description</b>	key cylinder with lever ø 18mm thread M18x1.25 rotation 90° cam length 53.5mm cam width 17mm Qty 1 pcs		

## knobs

### miscellaneous

 <p>1</p>			
<b>Part No.</b>	692677	<b>Ref. No.</b>	HSC350-20 SLZI0001
<b>description</b>	knob ø 26mm grey zero mark for thermostat shaft diameter 6x4mm Qty 1		

## hinges

### door bearing

 <p>1</p>			
<b>Part No.</b>	692396	<b>Ref. No.</b>	GSC1100-11
<b>description</b>	bush L 25mm ø 12mm ID ø 9.4mm transparent for door hinge Qty 1 pcs		

## handles and hand wheels

### handle rails

#### handle rails

 <p>1</p>			
<b>Part No.</b>	699449	<b>Ref. No.</b>	HSC350DD-48 HSC350DD-52 SLZB0020
<b>description</b>	handle rail for fridge L 220mm W 36mm H 23mm grey hole distance 120mm		

 <p>1</p>			
<b>Part No.</b>	701280	<b>Ref. No.</b>	GSC1100-10 WJMA4002
<b>description</b>	door hinge L 42mm W 33mm H 82mm mounting pos. bottom right/ left set Qty 1 pcs		

 <p>1</p>			
<b>Part No.</b>	698869	<b>Ref. No.</b>	HSC800-50 SLZB0037
<b>description</b>	handle rail thread M4 L 300mm		

 <p>1</p>			
<b>Part No.</b>	701281	<b>Ref. No.</b>	GSC1100-13 WJMA4005
<b>description</b>	door hinge L 43mm W 82mm H 71mm mounting pos. upper right/ left set Qty 1 pcs		

## locks

### locking devices

#### producer-specific

#### DUKERS

 <p>1</p>			
<b>Part No.</b>	692395	<b>Ref. No.</b>	GSC1100-32
<b>description</b>	key cylinder ø 14mm rotation 90° cam length 43mm cam width 12mm Qty 1 pcs		

 <p>1</p>			
<b>Part No.</b>	694927	<b>Ref. No.</b>	HSC360-29
<b>description</b>	hinge L 105mm W 52mm H 34mm bolt 17mm bolt ø 7mm		

 <p>1</p>			
<b>Part No.</b>	701284	<b>Ref. No.</b>	GBC1001-43 GBC1002-46 GBC1003-46
<b>description</b>	hinge L 39mm W 39mm H 23mm Qty 1 pcs		





			
1			
<b>Part No.</b>	694968	<b>Ref. No.</b>	HSC350DD-25 WJMA2020
<b>description</b>	hinge L 77mm W 19mm H 42mm mounting distance 27mm mounting distance 2 27mm mounting pos. centre thickness 3mm bolt 18/22mm bolt ø 7mm		

			
1			
<b>Part No.</b>	694926	<b>Ref. No.</b>	HSC360-23 WJMA2012
<b>description</b>	hinge L 82mm W 42mm H 50mm mounting pos. lower bolt 19mm bolt ø 9mm		

			
1			
<b>Part No.</b>	694592	<b>Ref. No.</b>	GSC1336-08 GSC1336-8 GSC2336-08 GSC2336-8
<b>description</b>	hinge L 82mm W 42mm H 50mm mounting pos. lower with bolt Qty 1 pcs		

			
1			
<b>Part No.</b>	694866	<b>Ref. No.</b>	HSC350-22 WJMA2003
<b>description</b>	hinge mounting pos. lower L 82mm W 53mm H 43mm mounting distance 30mm mounting distance 2 56mm thickness 4mm bolt 20mm bolt ø 7mm		

			
1			
<b>Part No.</b>	694865	<b>Ref. No.</b>	HSC350-32 WJMA0004
<b>description</b>	hinge mounting pos. upper L 50mm W 33mm H 42mm mounting distance 27mm thickness 3mm bolt 32.5mm bolt ø 9mm Qty 1kg		

			
1			
<b>Part No.</b>	694593	<b>Ref. No.</b>	GSC1336-06 GSC1336-6 GSC2336-06 GSC2336-6
<b>description</b>	hinge mounting pos. upper with bolt Qty 1 pcs		

## equipment feet and end caps

## screw-in feet

			
1			
<b>Part No.</b>	701279	<b>Ref. No.</b>	GBC1001-23 GBC1002-24 GBC1003-24 HSC350-14 HSC360-18 WJLB0008
<b>description</b>	equipment foot thread M8 thread L 22mm ø 35mm H 38mm Qty 1 pcs		

## miscellaneous

## with fixing plate

## ø30mm

			
1			
<b>Part No.</b>	701277 <sup>1</sup>	<b>Ref. No.</b>	GSC1336-42 GSC2336-42 HBC1002-24 HBC2003-24 WJLA1001 WJLA1009
<b>description</b>	swivel castor 2 with & 2 without brake ø 30mm plate fixing housing zinc-plated sheet steel plate size 61x51mm hole distance mm capacity 60kg bearing slide bearing wheel body PVC tread PVC H 44mm wheel width 23.5mm		

<sup>1</sup>with swivel brake

			
1			
<b>Part No.</b>	701523	<b>Ref. No.</b>	HSC350-13 HSC360-17 WJLA2001
<b>description</b>	swivel castor ø 31mm plate fixing H 45mm wheel width 22.5mm Qty 1 pcs		



ø75mm



1

<b>Part No.</b>	701282	<b>Ref. No.</b>	GSC1100-30 HSC800-14 WJLA1002
<b>description</b>	swivel castor set 2 with & 2 without brake ø 75mm plates fixing 102x83mm housing zinc-plated sheet steel hole distance 55/75mm bearing slide bearing H 112mm wheel width 31mm Qty 4 pcs		

## shelves and shelf rails

### grates

#### universal

#### without upstand



1

<b>Part No.</b>	970801	<b>Ref. No.</b>	GBC1003-43 HBC2003-40 WJGA9008
<b>description</b>	grate W 345mm D 400mm chrome-plated steel wire gauge frame 6mm lengthwise wires gauge 2.5mm crossing wires 4 Qty 1 pcs		



1

<b>Part No.</b>	970800	<b>Ref. No.</b>	GBC1001-41 WJGA9002
<b>description</b>	grate W 345mm D 500mm chrome-plated steel wire gauge frame 6mm lengthwise wires gauge 2.5mm crossing wires 4 Qty 1 pcs		



1

<b>Part No.</b>	970906	<b>Ref. No.</b>	GBC1002-43 GBC1003-43A GBC1003-43C HBC1002-40 WJGA9005
<b>description</b>	grate W 400mm D 345mm chrome-plated steel wire gauge frame 6mm crossing wires 4		

producer-specific



1

<b>Part No.</b>	970921	<b>Ref. No.</b>	GSC1336-40 GSC2336-40 HSC350-44 WJGA2010
<b>description</b>	grate W 500mm D 425mm H 38mm plastic-coated steel wire gauge frame 6.5mm lengthwise wires gauge 2.5mm crossing wires 6 white Qty 1kg		



1

<b>Part No.</b>	970910	<b>Ref. No.</b>	HSC360-38
<b>description</b>	grate W 530mm D 380mm H 40mm plastic-coated steel wire gauge frame 6mm lengthwise wires gauge 3mm crossing wires 23		



1

<b>Part No.</b>	970799	<b>Ref. No.</b>	GSC1100-09 WJGA4078
<b>description</b>	grate W 540mm D 505mm H 41mm plastic-coated steel wire gauge frame 6mm lengthwise wires gauge 3mm crossing wires 3 white Qty 1 pcs		

### accessories



1

<b>Part No.</b>	699311	<b>Ref. No.</b>	HSC800-46
<b>description</b>	profile L 400mm W 28mm H 15mm for grate		

### shelf rails and supports

producer-specific



1

<b>Part No.</b>	698870	<b>Ref. No.</b>	GBC1001-25 GBC1002-26 GBC1003-26 HBC1002-26 HBC2003-26 LCCJ2001
<b>description</b>	guide L 390mm W 25mm mounting pos. left/right inner height 4mm		

<b>Part No.</b>	701278	<b>Ref. No.</b>	GSC1100-37
<b>description</b>	rack L 1290mm W 26mm hole distance 22mm Qty 1 pcs aperture 10x10mm		



<b>Part No.</b>	698887	<b>Ref. No.</b>	HSC800-27
<b>description</b>	rack L 1400mm W 25mm H 4.5mm hole distance 21mm Qty 1 pcs		



<b>Part No.</b>	692399	<b>Ref. No.</b>	GSC1100-38
<b>description</b>	shelf support L 24mm W 7mm H 28mm aluminium for fridge Qty 1 pcs		



<b>Part No.</b>	692398	<b>Ref. No.</b>	GBC1001-42 GBC1002-44 GBC1003-44 HBC1002-41 HBC1003-41 HBC2003-41 LCCK0002
<b>description</b>	shelf support L 24mm W 9mm H 29mm aluminium for fridge Qty 1 pcs		



<b>Part No.</b>	694591	<b>Ref. No.</b>	GSC1336-39 GSC2336-39 HSC350-27 SLZE0028
<b>description</b>	shelf support L 33mm W 9mm H 27mm aluminium for fridge Qty 1 pcs		

**gaskets**

refrigeration gaskets

plug-in gaskets

profile 9161

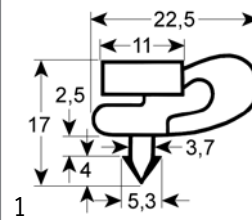

<b>Part No.</b>	902208	<b>Ref. No.</b>	HSC360-39 SLJP2025
<b>description</b>	refrigeration gasket profile 9161 W 590mm L 1540mm plug size		

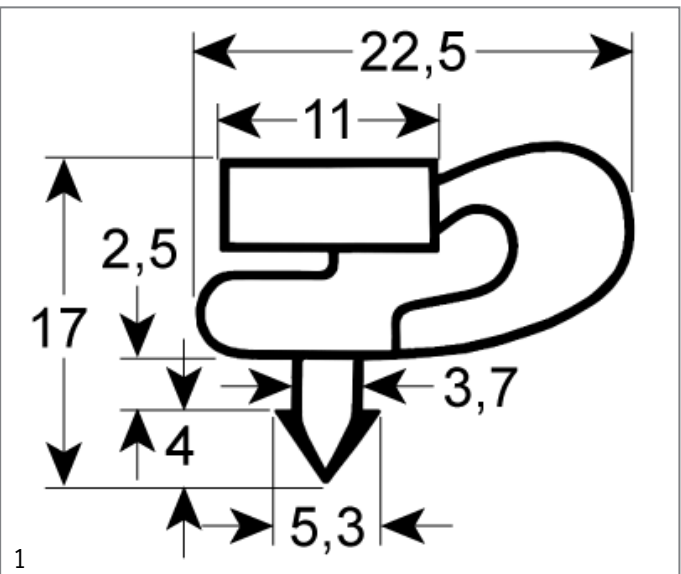

<b>Part No.</b>	902465	<b>Ref. No.</b>	HSC350DD-46 HSC350DD-49 SLJP2015
<b>description</b>	refrigeration gasket profile 9161 W 590mm L 650mm plug size		

profile 9156

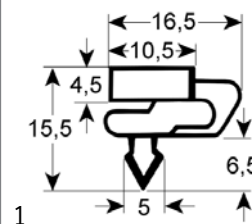

<b>Part No.</b>	901662	<b>Ref. No.</b>	GSC1100-14 GSC1100-14 (569x1295) SLJP4007
<b>description</b>	door seal profile 9156 W 569mm L 1295mm plug size Qty 1 pcs		



<b>Part No.</b>	901674	<b>Ref. No.</b>	GBC1002-48
<b>description</b>	refrigeration gasket profile 9156 W 415mm L 775mm plug size Qty 1 pcs		

<b>Part No.</b>	901660	<b>Ref. No.</b>	GBC1001-45
<b>description</b>	refrigeration gasket profile 9156 W 420mm L 785mm plug size Qty 1 pcs		

<b>Part No.</b>	901999	<b>Ref. No.</b>	GSC1100-14 (570x1400)
<b>description</b>	refrigeration gasket profile 9156 W 570mm L 1400mm plug size until 2009		

<b>Part No.</b>	901648	<b>Ref. No.</b>	GSC1336-44 GSC2336-44 HSC350-45 SLJP2010
<b>description</b>	refrigeration gasket profile 9156 W 595mm L 1340mm plug size Qty 1 pcs		

**profile 9314**

<b>Part No.</b>	902158	<b>Ref. No.</b>	HSC800-53
<b>description</b>	refrigeration gasket profile 9314 Wmm L 1200mm		

**miscellaneous**

<b>Part No.</b>	902210	<b>Ref. No.</b>	HBC2003-52 JNMA0000
<b>description</b>	gasket L 930mm Qty 1 dimensions 5x6mm		

## refrigeration cycle components

- filter driers
- accessories
- holders

<b>Part No.</b>	699297	<b>Ref. No.</b>	GBC1001-10 GBC1002-10 GBC1003-10 HBC1002-10 HBC2003-10 HSC360-15 HSC800-11 SLJAC008
<b>description</b>	bracket L 40mm W 30mm H 31mm ID ø 18mm ED ø 22mm for dryer		

**miscellaneous**

<b>Part No.</b>	750381	<b>Ref. No.</b>	GBC1001-09 GBC1002-09 GBC1003-09 GSC1336-32 GSC2336-32 HBC1002-09 HBC2003-09 HSC360-14 TCGV0002
<b>description</b>	dryer ø 18.5mm L 115.5mm connection 2,4/5,2mm Qty 1 pcs		



			
1			
<b>Part No.</b>	750382	<b>Ref. No.</b>	GSC1100-31 HSC350-10 HSC800-10 TCGV0002 HSC350-10 TCGV0009
<b>description</b>	dryer ø 18.5mm L 120mm connection 4/7mm Qty 1 pcs		
<b>accessories for</b>	750382		
	<b>Part No.</b>	694868	<b>Ref. No.</b> HSC350-11
bracket for dryer L 40mm W 30mm H 31mm Qty 1 pcs			

## refrigeration pipes

## copper pipes uninsulated

			
1			
<b>Part No.</b>	692730	<b>Ref. No.</b>	HBC1002-12 HBC2003-12 TCGO3004
<b>description</b>	copper pipe ID ø 4mm ED ø 6mm L 0.095m		

## heating tubes

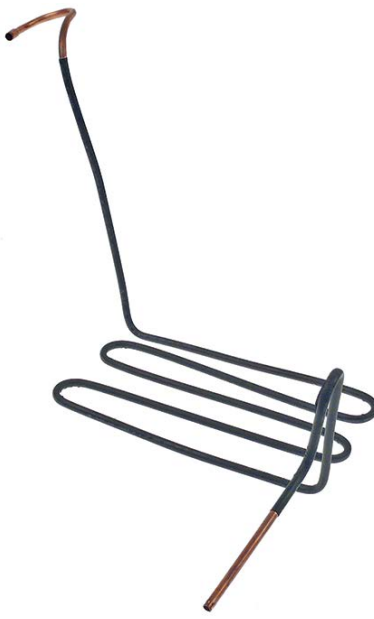
			
1			
<b>Part No.</b>	701495	<b>Ref. No.</b>	HSC800-08 TCGD4010
<b>description</b>	heater ED ø 6mm ID ø 5mm Qty 1m for evaporator connection ø 6mm		

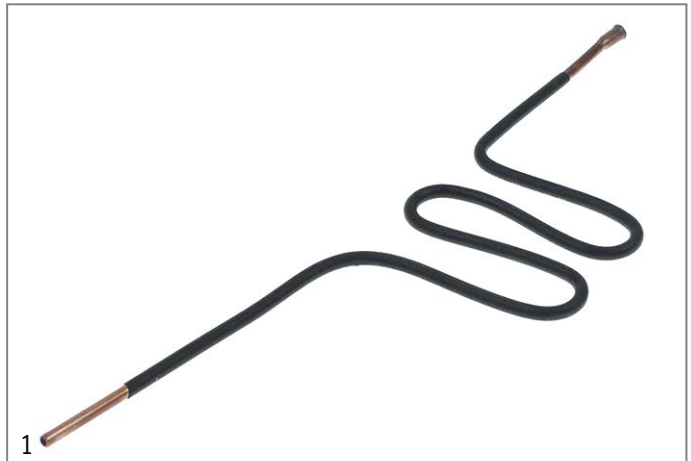

1			
<b>Part No.</b>	701432	<b>Ref. No.</b>	HSC350-08 HSC360-12
<b>description</b>	heater pipe ED ø 5mm ID ø 3mm L 350mm copper Qty 1		

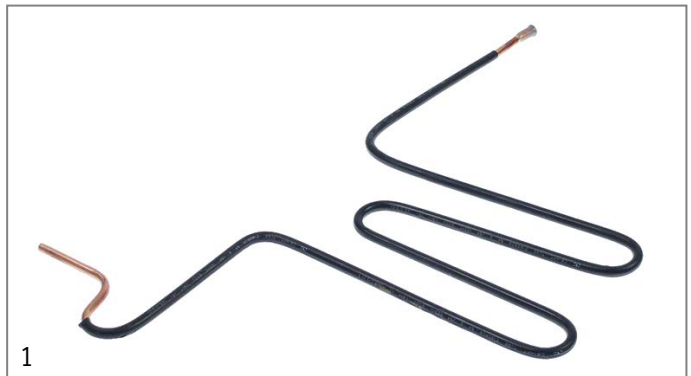

1			
<b>Part No.</b>	701582	<b>Ref. No.</b>	GBC1001-13 GBC1002-11 GBC1003-11 HBC1002-11 HBC2003-11 TCGD2001
<b>description</b>	heater pipe ED ø 5mm ID ø 3mm L 355mm H 250mm		

## evaporators

## for fridges

## producer-specific

			
1			
<b>Part No.</b>	750387	<b>Ref. No.</b>	GBC1001-39 TLZA9000
<b>description</b>	evaporator for fridge GBC1001 L 430mm W 500mm		



			
1			
<b>Part No.</b>	750376	<b>Ref. No.</b>	GBC1002-41 HBC1002-38 TLZD9001
<b>description</b>	evaporator for fridge GBC1002 L 760mm W 500mm		

			
1			
<b>Part No.</b>	750456	<b>Ref. No.</b>	HSC360-21
<b>description</b>	evaporator for fridge HSC360 L 780mm W 495mm		

			
1			
<b>Part No.</b>	750377	<b>Ref. No.</b>	GBC1003-41 TLZD9002
<b>description</b>	evaporator for fridge L 1000mm W 500mm		

			
1			
<b>Part No.</b>	750634	<b>Ref. No.</b>	HBC2003-38
<b>description</b>	evaporator L 1000mm W 510mm		

			
1			
<b>Part No.</b>	750345	<b>Ref. No.</b>	GSC1336-16 GSC2336-16
<b>description</b>	evaporator L 520mm W 180mm H 160mm		

			
1			
<b>Part No.</b>	750728	<b>Ref. No.</b>	GSC1100G-39
<b>description</b>	evaporator L 610mm W 120mm H 215mm		

			
1			
<b>Part No.</b>	750660	<b>Ref. No.</b>	HSC800-42 TLZA4003
<b>description</b>	evaporator L 620mm W 225mm H 160mm		

			
1			
<b>Part No.</b>	750375	<b>Ref. No.</b>	GSC1100-19 TLZA4004
<b>description</b>	evaporator L 760mm W 140mm H 225mm		

accessories

miscellaneous

			
1			
<b>Part No.</b>	692425	<b>Ref. No.</b>	GSC1336-28 GSC2336-28
<b>description</b>	bush for evaporator plastic ø 24mm L 34mm Qty 1 pcs		





# condensors

## condensors

mechanical components,  
equipment accessories

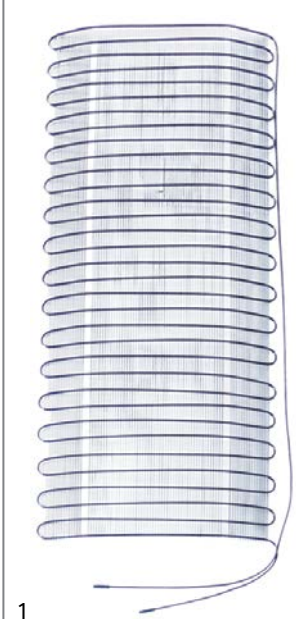

1

<b>Part No.</b>	750346	<b>Ref. No.</b>	DTLB2004 GSC1336-27 GSC2336-27 HSC350-02 HSC350DD-02 HSC360-02
<b>description</b>	condenser L 1430mm W 520mm		



1

<b>Part No.</b>	750373	<b>Ref. No.</b>	DTLA9002 GBC1002-06 HBC2003-06
<b>description</b>	condenser W 190mm D 160mm H 205mm Qty 1 pcs		



1

<b>Part No.</b>	750372	<b>Ref. No.</b>	DTLA9000 GBC1001-06
<b>description</b>	condenser W 195mm D 80mm H 205mm Qty 1 pcs		



1

<b>Part No.</b>	750385	<b>Ref. No.</b>	GBC1003-06 HBC1002-06
<b>description</b>	condenser W 255mm D 180mm H 205mm Qty 1 pcs		



1

<b>Part No.</b>	750659	<b>Ref. No.</b>	HSC800-06
<b>description</b>	condenser W 290mm D 180mm H 215mm Qty 1 pcs		



1

<b>Part No.</b>	750729	<b>Ref. No.</b>	GSC1100G-17
<b>description</b>	condenser W 395mm D 235mm H 275mm		



1

<b>Part No.</b>	750374	<b>Ref. No.</b>	DTLA4008 GSC1100-29
<b>description</b>	condenser W 555mm D 100mm H 275mm Qty 1 pcs		

## evaporation and condensing trays

### evaporation trays



1

<b>Part No.</b>	699308	<b>Ref. No.</b>	GBC1002-14 GBC1003-14
<b>description</b>	evaporation tray L 120mm W 74mm H 58mm Qty 1 pcs		



1

<b>Part No.</b>	699302	<b>Ref. No.</b>	GBC1001-12 SLZJ0021
<b>description</b>	evaporation tray L 185mm W 130mm H 75mm		



1

<b>Part No.</b>	699299	<b>Ref. No.</b>	GSC1336-47 HSC350-09 HSC360-13 SLZJ0014
<b>description</b>	evaporation tray L 210mm W 105mm H 80mm		

### unheated condensing trays



1

<b>Part No.</b>	750632	<b>Ref. No.</b>	HBC1002-14 HBC2003-14 SLZJ0022
<b>description</b>	drip tray L 187mm W 128mm H 70mm plastic		



1

<b>Part No.</b>	750631	<b>Ref. No.</b>	GSC1100-27 HSC800-09 SLZJ0015
<b>description</b>	drip tray L 302mm W 204mm H 85mm plastic		

**GASTRO**PARTS.COM

