



GASTROPARTS

Diamond

- [EN]** Equipment
- [DE]** Geräte
- [ES]** Aparatos
- [FR]** Équipement
- [IT]** Attrezzature
- [PL]** Urządzenia
- [RU]** Оборудование

✉ gastroparts@gastroparts.com

☎ +48 56 657 00 66

📘 fb.com/gastroparts.global

GASTROPARTS.COM





heating elements

heating elements for pizza ovens



1

Part No.	419072	Ref. No.	A87RZ65058
description	heating element 2800W 230V L 645mm W 550mm thread 1/4" mounting distance 537mm connection length 100mm connection male faston 6.3mm tube ø 8.5mm heating circuits 1 dry heating element 2 hole fixing		

heating elements for convection



1

Part No.	418042	Ref. No.	01200390
description	heating element 1200W 230V heating circuits 1 ID ø 180mm ED ø 194mm L 245mm H 34mm L1 44mm W1 31mm H1 15mm H2 18mm flange length 70mm flange width 22mm hole distance 56mm connection male faston 6.3mm tube ø 6.3mm convection heating element hole ø 5mm rectangular flange		
spare parts for	418042		
	Part No.	510368	Ref. No. —
	gasket L 70mm W 23.5mm hole ø 5mm hole distance 56mm FIBER thickness 2mm for heating element		



1

Part No.	380037	Ref. No.	35ERE101230V
description	energy regulator 240V 13.5A turn direction right shaft ø 6x4.6mm shaft L 13mm mounting thread 3/8"-24UNF equiv. no. 35ERE101230V		



1

Part No.	380038	Ref. No.	35ERE105024V
description	energy regulator 24V 13.5A turn direction right shaft ø 6x4.6mm mounting thread 3/8"-24UNF equiv. no. 35ERE105024V voltage AC		



1

Part No.	380039	Ref. No.	35ERE104400V
description	energy regulator 400V 13.5A turn direction right shaft ø 6x4.6mm mounting thread 3/8"-24UNF equiv. no. 35ERE104400V		
accessories for	380039		
	Part No.	361181	Ref. No. —
	nut thread 1/8" H 4.5mm nickel-plated brass WS 14 Qty 1 pcs		

energy regulators

DIAMOND



1

Part No.	380032	Ref. No.	45ER104C1
description	energy regulator 230V 13.5A turn direction right shaft ø 6x4.6mm shaft L 23mm mounting thread M4 equiv. no. 45ER104C1		



fans

hot air motors



Part No.	601993	Ref. No.	030340020018 2002010009 56403900
description	fan motor 230V 1 phase 50Hz 0.18/0.12kW 2800rpm speeds 1 L1 85mm L2 65mm L3 23mm D1 ø 8mm D2 ø 6mm M5x0.8 0.8A suitable capacitor 5µF/450V		
accessories for	601993		
	Part No.	365017	Ref. No. —
	operating capacitor capacity 5µF 450V tolerance 5% 50/60Hz ambient temperature max. -25 to +85°C ø 28mm L 54mm M8 plastic connection male faston 6.3mm 16.10.08 protection		

spare parts for	501484		
	Part No.	698769	Ref. No. —
	pump casing ø 125mm outlet ø 24/37mm		
	Part No.	698810	Ref. No. —
	O-ring EPDM thickness 3.56mm ID ø 112mm Qty 1 pcs		
	Part No.	698827	Ref. No. —
	threaded ring LGB pump type LA50 ø 120mm ID ø 70mm		

equipment-specific units

for dishwashers

washing and rinsing systems

	1		
Part No.	507541	Ref. No.	437102
description	flat gasket rubber ED ø 74mm ID ø 57mm thickness 2mm Qty 1 pcs		

	1		
Part No.	518637	Ref. No.	429073
description	nut for wash arm support thread M56x2		

	1		
Part No.	524811	Ref. No.	303037
description	ring for wash arm ID ø 41mm ED ø 45mm thickness 3mm plastic		

knobs

miscellaneous

	1		
Part No.	111913	Ref. No.	36MD
description	knob		

pumps

wash and rinse pumps

LGB



Part No.	501484	Ref. No.	69122
description	pump inlet ø 42mm outlet ø 37/24mm type LA50 230V 50Hz 1 phase 0.47kW L 220mm rotation direction right capacitor 10µF auxiliary pressure connection 8mm LGB		
spare parts for	501484		
	Part No.	365015	Ref. No. —
	operating capacitor capacity 10µF 400V tolerance 5%Hz ambient temperature max. -25 to +85°C ø 35.5mm L 59mm M8 plastic connection male faston 6.3mm protection		
	Part No.	510702	Ref. No. —
	mechanical shaft seal height counter ring 5.5mm ID ø 12mm		
	Part No.	521024	Ref. No. —
	impeller ø 88mm H 30mm rotation direction right thread M7L shaft ø 12mm blades 6		
	Part No.	698767	Ref. No. —
	fan blade ø 110mm H 18mm shaft intake ø 12mm plastic blades 6		
	Part No.	698768	Ref. No. —
	pump cover LGB inlet ø 42mm pump type LA50 AP ø 115mm ID ø 36mm		



gaskets

refrigeration gaskets

plug-in gaskets

profile 9010

We offer custom-made gaskets for this profile

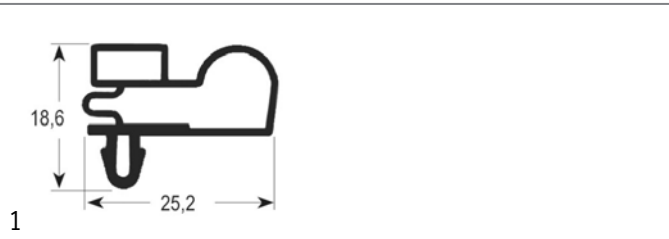

Part No.	900598	Ref. No.	9DEH25-0016
description	refrigeration gasket profile 9010 W 655mm L 1550mm plug size		

sealing washers

rubber gaskets



Part No.	507541	Ref. No.	437102
description	flat gasket rubber ED ø 74mm ID ø 57mm thickness 2mm Qty 1 pcs		

evaporators

for fridges

producer-specific



Part No.	750153	Ref. No.	9STU64860126
description	evaporator L 390mm W 75mm H 300mm complete with fan		

GASTROPARTS.COM

