



GASTROPARTS

Dean

- [EN]** Equipment
- [DE]** Geräte
- [ES]** Aparatos
- [FR]** Équipement
- [IT]** Attrezzature
- [PL]** Urządzenia
- [RU]** Оборудование

✉ gastroparts@gastroparts.com

☎ +48 56 657 00 66

📘 fb.com/gastroparts.global

GASTROPARTS.COM





heating elements

heating elements for fryers

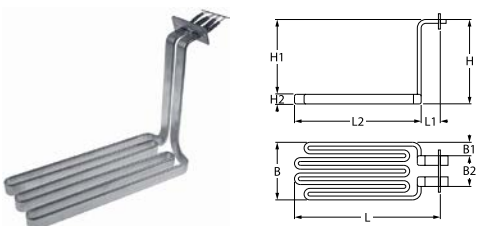

Part No.	417623	Ref. No.	8262155
description	heating element 8500W 240V L 400mm W 145mm H 300mm flange connection plug heating circuits 3 fryer heaters L1 352mm L2 30mm H1 255mm H2 25mm hole distance 85mm hole ø 6mm flange length 101mm flange width 35mm cable length 1000mm		

thermostats

control and safety thermostats

INVENSYS / ROBERTSHAW

control thermostats



Part No.	390636	Ref. No.	1175 1204 2557 807-3515
description	thermostat t.max. 204°C temperature range 93-204°C 1-pole 1NO 0.67A probe ø 9.5mm probe L 123mm capillary pipe 915mm capillary pipe isolatedmm gland nut 1/4" NPT shaft ø 6x4.6mm shaft L 21mm shaft position lower rotation 315° probe material nickel-plated probe thread 1/4" US		





gas valves and ignition boxes

gas control valves

ROBERTSHAW

millivolt controlled valves



Part No.	580031	Ref. No.	1896
description	gas valve supply Operator millivolt gas inlet 3/4" NPT gas outlet 3/4" NPT thermocouple connection pilot connection 1/4" CCT type 7000BMVR pressure controller natural gas 3.5" W.C. suitable for ROBERTSHAW		
spare parts for	580031		
	Part No.	101422	Ref. No. —
operator natural gas supply Operator millivolt			
	Part No.	106109	Ref. No. —
locking screw thread 7/16"-24 UNS for pipe ø 1/4" L 16mm brass Qty 1 pcs WS 7/16" (11.113mm) hole ø 6.4mm			
	Part No.	106121	Ref. No. —
pressure controller natural gas 3.5" W.C.			
	Part No.	580033	Ref. No. —
knob suitable for ROBERTSHAW			

ignition parts

thermocouples

thermocouple sets universal



Part No.	102281	Ref. No.	1149
description	thermocouple set ROBERTSHAW 5-piece L 24" - 610mm		



thermopiles

Part No. 580035 **Ref. No.** 1897

description thermopile L 36" - 915mm probe \varnothing 9mm probe L 38mm 250-750mV screw connection 7/16" connection 3/8" NEF

Part No. 103243 **Ref. No.** 807-3485
810-2033

description thermopile with PG9 adapter WHITE RODGERS L 36" - 915mm probe \varnothing 9mm probe L 40mm 250-750mV screw connection 7/16" connection spate terminals

Part No. 970183 **Ref. No.** 1362
2608
803-0307
S2139

description fryer basket L1 308mm W1 160mm H1 135mm

Part No. 970184 **Ref. No.** 1727

description fryer basket L1 330mm W1 315mm H1 135mm

baskets

fryer baskets

US producers

Part No. 970134 **Ref. No.** 1953

description fryer basket L1 280mm W1 140mm H1 105mm

GASTROPARTS.COM

