



GASTROPARTS

Conti

[EN] Equipment

[DE] Geräte

[ES] Aparatos

[FR] Équipement

[IT] Attrezzature

[PL] Urządzenia

[RU] Оборудование

✉ gastroparts@gastroparts.com

☎ tel. +48 56 657 00 66

📘 fb.com/gastroparts.global

GASTROPARTS.COM







heating elements

heating elements for coffee machine



			
Part No.	417254	Ref. No.	411004 411004+408714
description	heating element 2500W 230V heating circuits 1 thread 1" L 200mm W 20mm H 20mm tube ø 8.3mm connection M4 connection length 27mm immersion heater flange with thread WS 30 coffee machine		
For models:	Club		

			
Part No.	417100	Ref. No.	N/A
description	heating element 2800W 230V heating circuits 3 mounting ø 66mm hole distance 66mm L 245mm W 43mm H 71mm L1 25mm L2 45mm L3 180mm H1 47mm H2 24mm hole ø 11mm tube ø 8.3mm connection male faston 6.3mm immersion heater 4 hole flange		

			
Part No.	417255	Ref. No.	411431
description	heating element 3400W 230V heating circuits 1 thread 1" L 555mm W 20mm H 22mm tube ø 8.3mm connection M4 connection length 27mm immersion heater flange with thread WS 30 coffee machine		
For models:	Club		

			
Part No.	417763	Ref. No.	425030
description	heating element 3600W 230V heating circuits 1 thread 1" L 330mm W 20mm H 22mm tube ø 8.3mm connection M4 connection length 27mm immersion heater flange with thread WS 30 coffee machine		

			
Part No.	417257	Ref. No.	165800 1658001 165900 1659001
description	heating element 3660/4355W 220/240V heating circuits 3 mounting ø 67mm hole distance 66.5mm L 425mm W 40mm H 69mm L1 33mm L2 42mm L3 350mm H1 44mm H2 25mm hole ø 11mm tube ø 8.5mm connection M6 immersion heater 4 hole flange copper		
For models:	Classica-PM, Classica-SA, Club, XeosEvolution2		

			
Part No.	417256	Ref. No.	410884
description	heating element 4500W 230V heating circuits 3 mounting ø 57.5mm hole distance 72mm L 320mm W 37mm H 50mm hole ø 8mm tube ø 8.5mm connection male faston 6.3mm immersion heater 3 hole flange		
For models:	TwinStar2		
accessories for	417256		
			
Part No.	526108	Ref. No.	4108841
O-ring silicone thickness 6.3mm ID ø 56.5mm Qty 1 pcs			

			
Part No.	417101	Ref. No.	N/A
description	heating element 5000W 230V heating circuits 3 mounting ø 66mm hole distance 64mm L 480mm W 42mm H 68mm L1 25mm L2 40mm L3 410mm H1 47mm H2 21mm hole ø 11mm connection M6x1 immersion heater 4 hole flange		

heating cartridges

			
Part No.	417283	Ref. No.	411261
description	heating cartridge ø 10mm L 51mm cable length 145mm coffee machine		
For models:	TwinStar2		

accessories

flange gaskets

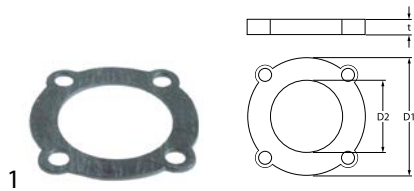
			
Part No.	528437	Ref. No.	N/A
description	gasket fibre D1 ø 99mm D2 ø 66mm thickness 2mm hole ø 11mm hole distance 69/65mm for heating element suitable for CONTI ID ø 66mm		

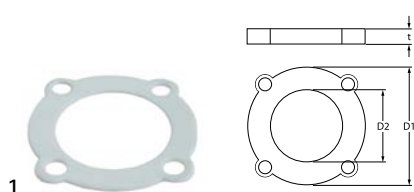
			
Part No.	528438	Ref. No.	N/A
description	gasket PTFE D1 ø 99mm D2 ø 68mm thickness 2mm hole ø 12mm hole distance 68mm ID ø 68mm		

thermostats

bi-metal thermostats

safety bi-metal thermostats

			
Part No.	375493	Ref. No.	410633
description	bi-metal safety thermostat hole distance 28mm switch-off temp. 230°C 1NC 1-pole 16A connection F6.3		
For models:	TwinStar2		



			
1			
Part No.	390693	Ref. No.	410634
description	bi-metal safety thermostat switch-off temp. 160°C 1NC 1-pole 16A connection F6.3 screw mounting thread M4		
For models:	Club, TwinStar2, XeosEvolution2		

bi-metal thermostats

			
1			
Part No.	390128	Ref. No.	411308
description	bi-metal thermostat hole distancemm switch-off temp. 95°C 1NC 1-pole 16A connection F6.3 M4		
For models:	TwinStar2		

control and safety thermostats

various

safety thermostats

			
1			
Part No.	376045	Ref. No.	415526
description	safety thermostat switch-off temp. 140°C 16A probe ø 6mm probe L 112mm capillary pipe 410mm capillary pipe isolated 20mm 400V		

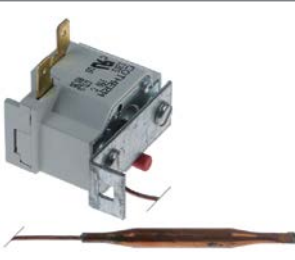
			
1			
Part No.	375496	Ref. No.	4069131 410634+410993
description	safety thermostat switch-off temp. 150°C temperature range 100°C 1-pole 1NC 20A probe ø 6mm probe L 64mm capillary pipe 1020mm		

accessories

miscellaneous



			
1			
Part No.	390776	Ref. No.	410993
description	screw connection for contact thermostat thread 3/8" hole ø M4mm WS 21		
For models:	Club		

switches and momentary switches

rocker/momentary rocker switches

30x22mm

labelled

			
1			
Part No.	301200	Ref. No.	408501
description	rocker switch mounting measurements 30x22mm black 2NO 230V 16A 0-1 connection male faston 6.3mm ambient temperature max. 85°C protection IP65 with cover cap		
For models:	Club, XeosEvolution2		
accessories for	301200		
	Part No.	301036	Ref. No. —
	protective cover internal size 30x22mm for rocker switch mounting measurementsmm		

miscellaneous

			
1			
Part No.	347247	Ref. No.	406956
description	rocker switch anthracite 1NO 250V 10A flush-mounted connection plug		
For models:	Classica-SA		

push/momentary push switches

30x22mm

			
1			
Part No.	301086	Ref. No.	411429
description	push switch mounting measurements 30x22mm black 2NO 250V 12A 0-1 connection male faston 6.3mm ambient temperature max. 85/55°C protection IP54 with protective collar		
For models:	Classica-SA		



ø25mm			
			
1			
Part No.	347222	Ref. No.	411509
description	push switch mounting ø 25mm blue 2NO 250V 16A illuminated connection male faston 6.3mm ambient temperature max. 125°C protection IP40		

			
1			
Part No.	359480	Ref. No.	408597
description	indicator light ø 8mm 230V red/green connection plug cable length 230mm temp.-resist. 90°C		
For models:	XeosEvolution2		

key lock switches			
			
1			
Part No.	400297	Ref. No.	410989
description	key lock switch 1 group thread M12x1 1NO mounting ø 12mm cable length 300mm		
For models:	TwinStar2		

ø12mm			
with screw socket			
			
1			
Part No.	359026	Ref. No.	411430
description	indicator light ø 12mm 230V red connection male faston 6.3mm model CM/5		
For models:	Classica-SA		

lamps

indicator lights

indicator lights (complete)			
ø 8mm			
			
1			
Part No.	359479	Ref. No.	408322 4083221
description	indicator light ø 8mm 230V green cable length 240mm temp.-resist. 90°C		
For models:	Club, XeosEvolution2		

contactors

ABB

power contactors			
			
1			
Part No.	381017	Ref. No.	405892
description	power contactor resistive load 30A 230VAC (AC3/400V) 17A/7.5kW main contacts 4NO auxiliary contacts connection screw connection type A16-40-00		
For models:	Club, TwinStar2, XeosEvolution2		

			
1			
Part No.	359477	Ref. No.	415534
description	indicator light ø 8mm 230V green connection plug cable length 240mm temp.-resist. 90°C		

auxiliary contactors			
			
1			
Part No.	380899	Ref. No.	408932
description	auxiliary contactor 230VAC AC1 5A AC15 3A connection screw connection contacts 2NO/2NC K6-22Z 220-240V		
For models:	Club		

			
1			
Part No.	359478	Ref. No.	408323 4083231
description	indicator light ø 8mm 230V red cable length 240mm temp.-resist. 90°C		
For models:	Club, XeosEvolution2		



auxiliary contacts



1

Part No.	381031	Ref. No.	408324
description	auxiliary contact contacts 1NO/1NC AC1 16A AC15 3A connection screw connection for contactors B6/B7/VB7		
For models:	TwinStar2, XeosEvolution2		

solid state relays

CRYDOM



1

Part No.	403540	Ref. No.	466092
description	solid state relay CRYDOM 1 phase 25A 240V 3-32VDC L 57mm W 45mm screw type CSW2425G		

miscellaneous

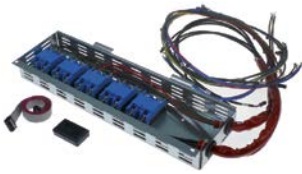

1

Part No.	402316	Ref. No.	410626 411850
description	solid state relay unit for Twin Star 2 2/3 groups		
For models:	TwinStar2		

relays



plug-in/print relays

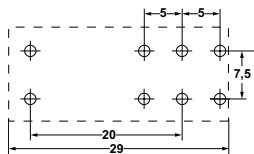

1



Part No.	380348	Ref. No.	411627
description	print relay 12VDC 1CO at 250V 16A connection pins raster size 5mm Italiana Relè manif. no. E61-12DC 95.65/95.75		
accessories for	380348		
	Part No.	380340	Ref. No. —
	relay socket dimensions 62x36x15mm 250V voltage AC 10A Italiana Relè manif. no. ZMEM/5		

accessories for	380348		
	Part No.	380505	Ref. No. —
	relay socket 2CO 40.52 dimensions 81.9x15.5x75mm 250V voltage AC 10A FINDER manif. no. 95.95.3		
	Part No.	381181	Ref. No. —
	relay socket 2-pole 40.51/40.52/40.61 connection screw clamp dimensions 15.8x78.6mm 250V voltage AC 10A FINDER manif. no. 95.75		

electronics

PCBs



1

Part No.	402248	Ref. No.	410877
description	display coffee machine L 80mm W 36mm		
For models:	TwinStar2		



1

Part No.	402301	Ref. No.	415086
description	display L 135mm W 44mm		

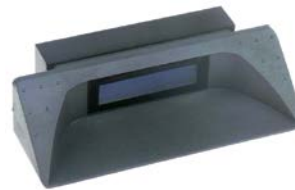

1

Part No.	402300	Ref. No.	410900
description	display L 159mm W 41mm with housing		
For models:	TwinStar2		



1

Part No.	402310	Ref. No.	415088
description	PCB blue LED 2 groups		



1

Part No.	402311	Ref. No.	415089
description	PCB blue LED 3 groups		

1

Part No.	402317	Ref. No.	415087
description	PCB transformer 9V voltage DC supply 230VAC		



1

Part No.	381315	Ref. No.	410626
description	relay shroud for heating L 91mm W 56mm suitable for CONTI 3x400V 6 relays supply 12VDC		

central units



1

Part No.	402313	Ref. No.	409837
description	central unit 2 groups CONTICLUB 220V type SDE3X CO3A voltage AC		
For models:	Club, XeosEvolution2		



1

Part No.	402312	Ref. No.	410885
description	central unit 2/3 groups edition 2002 type TS2		
For models:	TwinStar2		



1

Part No.	402314	Ref. No.	415085
description	central unit 230V type 3d5 MAESTRO DELUXE per SLAVE 6T „XEOS“ voltage AC		





1

Part No.	402315	Ref. No.	411901
description	central unit 230V type SDE3P CO2A voltage AC		



1

Part No.	402296	Ref. No.	4098374 411576 411900	
description	central unit set edition ESSIKA central unit SDE3P CO2A solid state relay cable fixing sheet			
spare parts for	402296			
	Part No.	402062	Ref. No.	—
	solid state relay CELDUC 1 phase 25A 12-280V 3-32VDC L 59mm W 46mm screw type SO942460			
	Part No.	402315	Ref. No.	411901
	central unit 230V type SDE3P CO2A voltage AC			



keypads

keypad units



1

Part No.	402307	Ref. No.	410887
description	keypad unit buttons 1 lighting blue L 51mm W 61mm with LED		
For models:	TwinStar2		



1

Part No.	402309	Ref. No.	411844V
description	keypad unit buttons 5 black ESSIKA		



1

Part No.	402308	Ref. No.	411244V
description	keypad unit buttons 5 blue ESSIKA		



1

Part No.	402305	Ref. No.	409838 411259
description	keypad unit buttons 5 L 107mm W 44mm with LED 3d5		



1

Part No.	402302	Ref. No.	410886
description	keypad unit buttons 5 lighting blue L 187mm W 50mm with LED		
For models:	TwinStar2		



1

Part No.	402303	Ref. No.	410103
description	keypad unit buttons 5 lighting yellow L 187mm W 50mm with LED		
For models:	Club, XeosEvolution2		



1

Part No.	402304	Ref. No.	410813
description	keypad unit buttons 5 lighting yellow/red complete		
For models:	Club		



1

Part No.	402306	Ref. No.	411001
description	keypad unit hot water buttons 1 lighting yellow L 51mm W 61mm with LED		
For models:	XeosEvolution2		

accessories



1

Part No.	347229	Ref. No.	410273
description	button external size 12mm internal size 4mm white		
For models:	TwinStar2, XeosEvolution2		





1

Part No.	347231	Ref. No.	410640
description	button suitable for CONTI		
For models:	XeosEvolution2		



			
1			
Part No.	347230	Ref. No.	410872
description	button suitable for CONTI grey		
For models:	TwinStar2		
accessories for	347230		
	Part No.	347229	Ref. No. 410273
	button external size 12mm internal size 4mm white		
	Part No.	347232	Ref. No. 410874
	light guide suitable for CONTI		
	Part No.	402302	Ref. No. 410886
	keypad unit buttons 5 lighting blue L 187mm W 50mm with LED		
	Part No.	526087	Ref. No. 410635
	compression spring ø 10.7mm L 14.5mm wire gauge ø 0.7mm		

			
1			
Part No.	347227	Ref. No.	406206
description	push button external size 23.5mm red mounting ø 20.6mm		
For models:	Club		

			
1			
Part No.	347234	Ref. No.	405348
description	rubber pad for push-button ø 16mm L 13mm		
For models:	Club, TwinStar2, XeosEvolution2		

solenoïd valves

solenoïd valves (water)

metal

ODE

solenoïd valves steam (water)

130A series

			
1			
Part No.	370557 ¹	Ref. No.	410615
description	solenoid valve stainless steel 230VAC connection 1/8" / M22x1 3-way -10 up to 140°C membranes FKM (water/steam) 60Hz		
For models:	TwinStar2		

¹SS housing

131K series

			
1			
Part No.	370556 ¹	Ref. No.	405620 4056201
description	solenoid valve stainless steel 230VAC connection M22x1 2-way slide-on receptacle DIN coil type BDV08220BW 50-60Hz		
For models:	Classica-SA, Club, TwinStar2, XeosEvolution2		

¹SS housing

			
1			
Part No.	347233	Ref. No.	405345
description	frame for push-button external size 28mm internal size 21mm black		
For models:	Club		

			
1			
Part No.	347232	Ref. No.	410874
description	light guide suitable for CONTI		
For models:	TwinStar2		

			
1			
Part No.	347228	Ref. No.	410782
description	push button external size 23.5mm grey mounting ø 20.6mm		
For models:	Club		



21A series



1

Part No.	370836	Ref. No.	367910 480347
description	solenoid valve brass 2-ways 230VAC inlet 1/4" outlet 1/4" L 40mm 21A2KE20 DN 2mm coil type BDP p max 22bar p min 0bar		
For models:	Club, XeosEvolution2		

4171K series



1

Part No.	370560	Ref. No.	367920
description	solenoid valve brass 2-ways 220-230V/50-60Hz inlet 1/4" outlet 1/4" connection 1/4" L 44mm ODE-4171-ZA DN 2.5mm slide-on receptacle DIN -10 up to 140°C coil type BDF membranes FKM (water/steam) p max 14bar p min 0bar 60Hz 220V voltage AC		
For models:	Club, TwinStar2		



1

Part No.	370559	Ref. No.	367910 (old version)
description	solenoid valve brass 2-ways 230VAC inlet 1/4" outlet 1/4" connection 1/4" L 44mm ODE-4171-F44 DN 2.5mm -10 up to 140°C coil type BDP membranes FKM (water/steam) p max 14bar p min 0bar		

PARKER

solenoid valves (various)



1



Part No.	370497	Ref. No.	411476
description	solenoid valve 2-ways 230VAC connection 1/8" L 30mm DN 1.5mm PARKER brass		
For models:	TwinStar2		

spare parts and accessories

valve bodies



1

Part No.	370062	Ref. No.	CON01	
description	solenoid valve body PARKER 3-ways outer cone			
accessories for	370062			
	Part No.	371029	Ref. No.	—
	solenoid coil PARKER 230VAC 9VA coil type ZB09 seat ø 14mm H 33mm W 34mm D 43mm			
	Part No.	371030	Ref. No.	—
	solenoid coil 24VDC 12VA coil type ZB12 seat ø 14mm			
	Part No.	371033	Ref. No.	—
	solenoid coil PARKER 230VAC 9VA coil type YB09 with cable seat ø 14mm			
	Part No.	371036	Ref. No.	—
	solenoid coil 24VAC 9VA coil type ZB09 seat ø 14mm			
	Part No.	371095	Ref. No.	—
	O-ring Viton thickness 1.78mm ID ø 6.07mm Qty 1 pcs			
	Part No.	371100	Ref. No.	—
	O-ring silicone thickness 1.78mm ID ø 6.07mm Qty 1 pcs			

pressure switches

for coffee machines

ø 34mm



1

Part No.	541699	Ref. No.	4301611 4651611	
description	pressure control ø 34mm pressure range 1.5-4bar with pipe NC 15A/ NO 9A 250V connection male faston 6.3mm 1CO difference 0.1-0.8bar pressure connection 1/4"			
For models:	TwinStar2			
spare parts for	541699			
	Part No.	541020	Ref. No.	—
	pressure control ø 38mm pressure range 0.5-1.2bar coffee machine parts pressure connection vertical preset at 1bar 16A 250V connection 1/4" pressure connection 1/4" GAS			

ø 38mm



1

Part No.	541700	Ref. No.	4119311
description	pressure control ø 38mm pressure range 0.5-1.2bar with pipe pressure connection vertical 16A 250V ambient temperature max. 125°C pressure connection 1/4"		



flow meters and flow sensors

flow meters

GICAR



1

Part No.	400004	Ref. No.	403466
description	flow meter thread 1/4" stainless steel with LED plug connection approval NSF		
For models:	Club, TwinStar2, XeosEvolution2		
accessories for	400004		
	Part No.	400256	Ref. No. —
	plug GICAR for flow meter		

pumps

booster pumps II

pump heads

FLUID-O-TECH



1

Part No.	500174	Ref. No.	4057225
description	pump head PA104 FLUID-O-TECH L 82mm 100l/h connection 3/8" GAS with bypass brass clip connection for coffee machine shaft ø 4.8x11mm NSF		
accessories for	500174		
	Part No.	520126	Ref. No. —
	clamp for pump/motor		

fuses

line circuit breakers

ABL SURSUM



1

Part No.	358121	Ref. No.	411020
description	line circuit breaker 1-pole 25A tripping type C rated 240/415V nominal 25A		
For models:	TwinStar2		

electric accessories

cables

ribbon cables

group 1



1

Part No.	400706	Ref. No.	409839
description	ribbon cable 16-pole L 1100mm plug type FC-16P raster size 2.54mm		
For models:	Club, TwinStar2, XeosEvolution2		



1

Part No.	400707	Ref. No.	409840
description	ribbon cable 16-pole L 1400mm plug type FC-16P raster size 2.54mm		
For models:	Club, XeosEvolution2		



1

Part No.	400228	Ref. No.	410629
description	ribbon cable 16-pole L 600mm plug type FC-16P raster size 2.54mm		
For models:	TwinStar2		



equipment-specific units

for espresso machines

filter holders

filter holders standard

filter holders (complete)



1

Part No.	526085	Ref. No.	409999 411611 411965
-----------------	--------	-----------------	----------------------------

description filter holder double ID ø 61.7mm outlet distance 48mm

For models: Classica-PM, Classica-SA, Club, XeosEvolution2

accessories for 526085

	Part No.	529013	Ref. No.	—
	coffee filter ø 70mm mounting ø 60.5mm H 25.5mm cups 2 amount of coffee 14g perforation ø 0.3x0.3mm square			

	Part No.	529014	Ref. No.	—
	coffee filter ø 70mm mounting ø 60mm H 21mm cups 2 amount of coffee 12g perforation ø 0.3mm round			

	Part No.	529023	Ref. No.	—
	blind filter ø 70mm mounting ø 60mm H 18mm			

	Part No.	529079	Ref. No.	—
	filter holder spring L 70mm W 60mm wire gauge ø 1.3mm for espresso filter holder			

	Part No.	529229	Ref. No.	—
	coffee filter ø 70mm mounting ø 60mm H 28mm cups 3 amount of coffee 21g			



1

Part No.	526084	Ref. No.	409998 411612 411964
-----------------	--------	-----------------	----------------------------

description filter holder single without filter mounting ø 83.5mm ID ø 61.7mm wedge height 11.2mm wedge position horizontal number of wedges 2

For models: Classica-PM, Classica-SA, Club, XeosEvolution2



1

Part No.	523044	Ref. No.	4056791 4099998
description	filter holder suitable for CONTI complete mounting ø 84mm ID ø 62mm outlet distance mm wedge height 8mm number of wedges 2		
For models:	Classica-PM, Classica-SA, Club, XeosEvolution2		

filters

for 1 cup



1

Part No.	527631	Ref. No.	N/A
description	coffee filter ø 70mm mounting ø 60.7mm H 17mm cups 1 amount of coffee 8g		

brewing units

shower screens

with upstand and central hole



1

Part No.	528472	Ref. No.	355900
description	shower screen ø 58mm H 11mm hole ø 6mm		
For models:	Classica-SA, Club, TwinStar2, XeosEvolution2		

filter holder gaskets

flat

standard



1

Part No.	526141	Ref. No.	002710
description	filter holder gasket D1 ø 73.3mm D2 ø 57.1mm H 8.3mm NBR 80+5 Qty 1 pcs		
For models:	Classica-PM, Classica-SA, Club, XeosEvolution2		



1			
Part No.	526140	Ref. No.	002700
description	filter holder gasket D1 ø 73.3mm D2 ø 57.1mm H 8mm NBR 80+5 Qty 1 pcs		
For models:	TwinStar2		

shim gaskets			
1			
Part No.	531250	Ref. No.	—
description	shim gasket D1 ø 73mm D2 ø 59mm thickness 0.5mm paper Qty 20 pcs		

brewing units with solenoid valve			
nozzles			
1			
Part No.	526131	Ref. No.	411552
description	nozzle hole ø 2mm thread 1/4" brass		
For models:	XeosEvolution2		

nozzle holders			
1			
Part No.	528466	Ref. No.	403456
description	nozzle holder thread 1/4" brass WS 17		
For models:	Classica-SA, Club, XeosEvolution2		

components			
nozzles			
with thread			
1			
Part No.	531071	Ref. No.	410704
description	nozzle bore ø 0.7mm thread M6x1 L 60mm		
For models:	TwinStar2		

washers			
1			
Part No.	526135	Ref. No.	411328
description	nozzle bore ø 0.75mm ED ø 7.5mm thickness 2mm		
For models:	XeosEvolution2		

screws			
1			
Part No.	560373	Ref. No.	401983
description	cylinder head bolt thread M4 thread L 12mm WS 3 SS Qty 1 pcs intake internal hexagon DIN 912/ISO 4762		
For models:	Classica-SA, Club, XeosEvolution2		

water dispersions			
water dispersions			
group 2			
1			
Part No.	526148	Ref. No.	411969
description	water distributor ø 30mm hole ø 1.2mm H 5.9mm grooves 6		

group 3			
1			
Part No.	526114	Ref. No.	4047401
description	water distributor ø 56.4mm H 10.2mm 6 holes hole ø 1.5mm thread M5 mounting ø 5.3mm bore ø 8.75mm brass		

1			
Part No.	528471	Ref. No.	404740
description	water distributor ø 56.4mm H 9.2mm 6 holes hole ø 1.5mm thread M5 mounting ø 5.3mm bore ø 8.75mm brass MK10		
For models:	Classica-SA, Club, XeosEvolution2		



			
1			
Part No.	531069	Ref. No.	411968
description	water distributor ø 56.5mm H 12.5mm 4 holes hole ø 1mm thread M5 mounting ø 5.2mm bore ø 8.7mm brass		

expansion valves

with hose connection

			
1			
Part No.	526452	Ref. No.	409774
description	expansion valve T1: 1/4" ET hose ø 9.5mm BL 42mm		
For models:	Classica-PM, Classica-SA, Club, XeosEvolution2		

drain pans

drain units

			
1			
Part No.	526118	Ref. No.	411307
description	drain unit connections 4x hose/1x 3/8" hose ø 8mm outlet 1/2" ESPRESSO		
For models:	TwinStar2		

			
1			
Part No.	526117	Ref. No.	410983
description	drain unit connections 5x hose/1x 3/8" hose ø 8mm outlet 1/2" MUG		
For models:	TwinStar2		

			
1			
Part No.	531068	Ref. No.	411775
description	drain unit hose ø 21mm		

drain pans

			
1			
Part No.	526101	Ref. No.	405386
description	drain pan ø 102mm H 41mm hole ø 14.5mm hose ø 19mm		
For models:	Classica-PM, Classica-SA, Club, XeosEvolution2		

				
1				
Part No.	526103	Ref. No.	408390	
description	drain pan set ø 102mm H 41mm hole ø 14.5mm suitable for XEOS			
For models:	Classica-PM, Classica-SA, Club, XeosEvolution2			
spare parts for	526103			
	Part No.	526101	Ref. No.	405386
	drain pan ø 102mm H 41mm hole ø 14.5mm hose ø 19mm			
	Part No.	526102	Ref. No.	408160
	drain pipe connection 9mm T1: 1/2" plastic			



1

Part No.	526104	Ref. No.	409834
description	drain pan set ø 102mm H 41mm hole ø 14.5mm suitable for XEOS		

pipes



1

Part No.	526102	Ref. No.	408160
description	drain pipe connection 9mm T1: 1/2" plastic		
For models:	Classica-PM, Classica-SA, Club, XeosEvolution2		

boilers

drain taps/drain valves



1

Part No.	526125	Ref. No.	409147
description	drain tap for boiler connection 3/8" brass		
For models:	XeosEvolution2		

steam/water taps

steam/water taps

steam/water taps



1

Part No.	526124	Ref. No.	430100V
description	steam/water tap inlet 3/8" ET outlet 3/8" ET		



1

Part No.	528451	Ref. No.	4095901
description	steam/water tap inlet 3/8" outlet M16x1.5 suitable for CONTI		
For models:	Classica-PM, Classica-SA, Club		

steam taps

steam taps (complete)



1

Part No.	526110	Ref. No.	410952 430012
description	steam tap complete inlet 3/8" outlet M16x1.5 steam		
For models:	TwinStar2		

components

bushes



1

Part No.	526123	Ref. No.	410703
description	bush for solenoid valve ID ø 1.7mm H 9.7mm thread M7x1		
For models:	TwinStar2		



1

Part No.	526122	Ref. No.	406316
description	bush for solenoid valve ID ø 2.65mm thread M7x1		
For models:	Classica-SA, TwinStar2		

gaskets



1

Part No.	526119	Ref. No.	407502
description	gasket D1 ø 13mm ID ø 5mm thickness 4mm EPDM		
For models:	Classica-PM, Classica-SA, Club, TwinStar2, XeosEvolution2		



1

Part No.	528452	Ref. No.	181100
description	sealing disc D1 ø 14mm thickness 3.5mm rubber		
For models:	Classica-PM, Classica-SA, Club, XeosEvolution2		



tap bodies



1

Part No.	526121	Ref. No.	405618
description	tap body T1: 3/8" IT T2: 3/8" ET		
For models:	XeosEvolution2		



1

Part No.	526134	Ref. No.	405586
description	tap body T1: 3/8" T2: 3/8" with solenoid valve 230V		
For models:	XeosEvolution2		



1

Part No.	531152	Ref. No.	470160V
description	tap body T1: 3/8" T2: 3/8" with solenoid valve 230V		

solenoid valves



1

Part No.	370556 ¹	Ref. No.	405620 4056201
description	solenoid valve stainless steel 230VAC connection M22x1 2-way slide-on receptacle DIN coil type BDV08220BW 50-60Hz		
For models:	Classica-SA, Club, TwinStar2, XeosEvolution2		

¹SS housing

union screws



1

Part No.	526120	Ref. No.	409594
description	union screw thread M22x1.25 ID ø 10mm WS 24		
For models:	Classica-PM, Classica-SA, Club		

steam/water pipes

steam pipes



1

Part No.	526112	Ref. No.	410229 411063 411920
description	steam pipe thread M16x1.5 H 140mm tube ø 10mm		
For models:	TwinStar2, XeosEvolution2		



1

Part No.	531070	Ref. No.	410834
description	steam pipe thread M16x1.5 H 175mm L 190mm tube ø 8mm stainless steel suitable for CONTI		
For models:	TwinStar2, XeosEvolution2		

water pipes



1

Part No.	528460	Ref. No.	410135
description	water pipe		
For models:	TwinStar2, XeosEvolution2		





1

Part No.	526111	Ref. No.	411930
description	water pipe thread M16x1.5 ø 23.5mm L 45mm WS 22		

accessories

bushes



1

Part No.	526146	Ref. No.	401320
description	bush D1 ø 13.6mm D2 ø 10.7mm H 3.6mm PTFE ID ø 7.05mm		
For models:	Classica-PM, Classica-SA, Club, TwinStar2, XeosEvolution2		

fine filters

fine filters



1

Part No.	528468	Ref. No.	403458
description	fine filter ø 8mm H 13.2mm		
For models:	Classica-SA, Club, XeosEvolution2		

intake valves

intake valves



1

Part No.	526133	Ref. No.	409790
description	intake valve water with non-return valve inlet 1/4" outlet 3/8"		
For models:	Club		



1

Part No.	528450	Ref. No.	406090
description	intake valve water with solenoid valve		
For models:	Classica-SA		

accessories

gaskets



1

Part No.	526119	Ref. No.	407502
description	gasket D1 ø 13mm ID ø 5mm thickness 4mm EPDM		
For models:	Classica-PM, Classica-SA, Club, TwinStar2, XeosEvolution2		

miscellaneous



1

Part No.	528422	Ref. No.	403473
description	ball ø 8mm SS		
For models:	Classica-PM, Classica-SA, Club, TwinStar2, XeosEvolution2		

level glasses

level glasses

gaskets



1

Part No.	528444	Ref. No.	233700
description	gasket D1 ø 17mm ID ø 11mm H 4mm rubber		
For models:	Classica-PM, Classica-SA		



1

Part No.	528441	Ref. No.	004700
description	gasket rubber ED ø 21mm ID ø 11mm thickness 10mm for level glass pipe Qty 1 pcs		

pressure rings



1

Part No.	528445	Ref. No.	233600
description	press ring D1 ø 18mm D2 ø 12.15mm thickness 3mm brass level glass		
For models:	Classica-PM, Classica-SA		

level glass pipes



1

Part No.	526143	Ref. No.	234000
description	water level tube ø 11mm H 114.5mm ID ø 8mm red		
For models:	Classica-PM, Classica-SA		



			
1			
Part No.	528442	Ref. No.	405831
description	water level tube ø 11mm H 145mm MK10		

pipes

pipes

			
1			
Part No.	526115	Ref. No.	411776
description	pipe ø 6mm T1: 1/8" cold water		

non-return valves

complete

			
1			
Part No.	526127	Ref. No.	409835
description	non-return valve inlet 1/4" ET outlet 1/4" IT L 37.6mm		
For models:	Classica-PM, Classica-SA, Club, XeosEvolution2		

			
1			
Part No.	526126	Ref. No.	409125
description	non-return valve inlet 1/4" outlet 3/8" L 67mm		
For models:	Club, XeosEvolution2		

			
1			
Part No.	526129	Ref. No.	4030652
description	non-return valve inlet 1/8" outlet 1/8" L 54mm		

screw connections



end caps

			
1			
Part No.	526100	Ref. No.	409832
description	end cap thread 1/2" L 15mm WS 26 plastic with gasket		
For models:	Classica-PM, Classica-SA, Club, XeosEvolution2		



hose connectors			
			
1			
Part No.		Ref. No.	409831
description	hose connector thread 1/2" L 53mm hose ø 15mm with gasket		



knobs

steam/water taps

steam/water taps			
			
1			
Part No.	111291	Ref. No.	4081561
description	knob ø 47mm shaft ø 8.2mm black		
For models:	Classica-PM, Classica-SA, Club		
spare parts for	111291		
	Part No.	111062	Ref. No. 405615
	knob spring L 20mm W 10mm H 11.5mm		

accessories

			
1			
Part No.	111291	Ref. No.	4081561
description	knob ø 47mm shaft ø 8.2mm black		
For models:	Classica-PM, Classica-SA, Club		
spare parts for	111291		
	Part No.	111062	Ref. No. 405615
	knob spring L 20mm W 10mm H 11.5mm		

			
1			
Part No.	111290	Ref. No.	405284
description	knob selector switch 1/0/arrow ø 47mm shaft 6x6		
For models:	Classica-SA		
accessories for	111290		
	Part No.	111062	Ref. No. 405615
	knob spring L 20mm W 10mm H 11.5mm		



miscellaneous



1

Part No.	111290	Ref. No.	405284
description	knob selector switch 1/0/arrow ø 47mm shaft 6x6		
For models:	Classica-SA		
accessories for	111290		
	Part No.	111062	Ref. No.
			405615
	knob spring L 20mm W 10mm H 11.5mm		

accessories

button springs



1

Part No.	526087	Ref. No.	410635
description	compression spring ø 10.7mm L 14.5mm wire gauge ø 0.7mm		
For models:	TwinStar2, XeosEvolution2		



1

Part No.	111062	Ref. No.	405615
description	knob spring L 20mm W 10mm H 11.5mm		
For models:	Classica-PM, Classica-SA, Club		

handles and hand wheels

lever handles



1

Part No.	526099	Ref. No.	410873
description	lever grey		
For models:	TwinStar2		



1

Part No.	526098	Ref. No.	410099
description	lever steam		
For models:	XeosEvolution2		



1

Part No.	111078	Ref. No.	405624
description	slide		
For models:	Classica-PM, Classica-SA		

accessories

miscellaneous



1

Part No.	526086	Ref. No.	408157
description	end cap CONTI round red ø 23mm		
For models:	Classica-PM, Classica-SA, Club		

gaskets

O-rings

EPDM

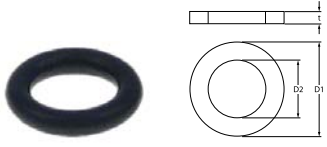

1

Part No.	526824	Ref. No.	087520
description	O-ring EPDM thickness 1.9mm ID ø 5.7mm Qty 1 pcs		
For models:	Classica-PM, Classica-SA, Club, TwinStar2, XeosEvolution2		

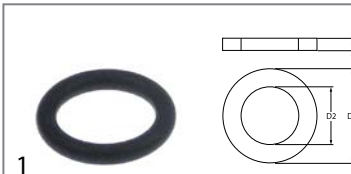

	
Part No.	526107
Ref. No.	055300
description	O-ring EPDM thickness 2.7mm ID ø 12.1mm Qty 1 pcs
For models:	Classica-PM, Classica-SA, Club, TwinStar2, XeosEvolution2

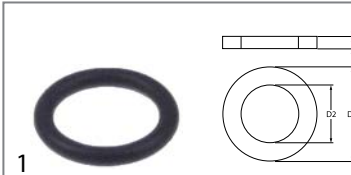
	
Part No.	525109
Ref. No.	061200
description	O-ring EPDM thickness 2.7mm ID ø 13.6mm Qty 1 pcs
For models:	Classica-PM, Classica-SA, Club, TwinStar2, XeosEvolution2

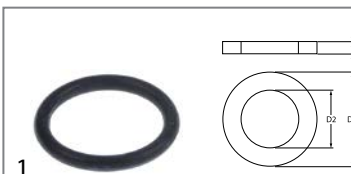
	
Part No.	526109
Ref. No.	411621
description	O-ring EPDM thickness 2.7mm ID ø 18.4mm Qty 1 pcs

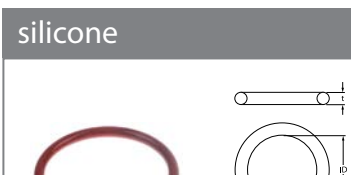
silicone	
	
Part No.	526108
Ref. No.	4108841
description	O-ring silicone thickness 6.3mm ID ø 56.5mm Qty 1 pcs
For models:	TwinStar2

Viton	
	
Part No.	526105
Ref. No.	405650
description	O-ring Viton thickness 1.5mm ID ø 5mm Qty 1 pcs
For models:	Club, XeosEvolution2

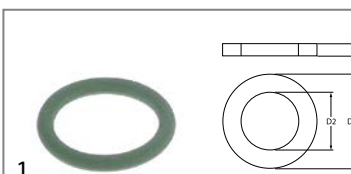
	
Part No.	526142
Ref. No.	409631
description	O-ring Viton thickness 2mm ID ø 12mm Qty 1 pcs
For models:	Classica-PM, Classica-SA, Club, TwinStar2, XeosEvolution2

sealing washers

rubber gaskets

	
Part No.	528441
Ref. No.	004700
description	gasket rubber ED ø 21mm ID ø 11mm thickness 10mm for level glass pipe Qty 1 pcs

copper gaskets

DIN-7603-A

	
Part No.	528197
Ref. No.	406709
description	flat gasket copper ED ø 10mm ID ø 6mm thickness 1mm Qty 1 pcs
For models:	Classica-SA, Club, TwinStar2, XeosEvolution2

	
Part No.	526090
Ref. No.	403475
description	flat gasket copper ED ø 11.7mm ID ø 8.5mm thickness 1.3mm Qty 1 pcs
For models:	Classica-PM, Classica-SA, Club, TwinStar2, XeosEvolution2

	
Part No.	526147
Ref. No.	403459
description	flat gasket copper ED ø 16.7mm ID ø 13.4mm thickness 0.8mm Qty 1 pcs

	
Part No.	528467
Ref. No.	403459
description	flat gasket copper ED ø 18.5mm ID ø 13.5mm thickness 1mm
For models:	Classica-SA, Club, XeosEvolution2

	
Part No.	526092
Ref. No.	403984
description	flat gasket copper ED ø 20.8mm ID ø 17.3mm thickness 1.4mm
For models:	Club, XeosEvolution2





			
1			
Part No.	526091	Ref. No.	181300
description	flat gasket copper ED ø 21mm ID ø 18.1mm thickness 1.4mm		
For models:	Classica-PM, Classica-SA, Club, XeosEvolution2		

			
1			
Part No.	526093	Ref. No.	411795
description	flat gasket copper ED ø 25.8mm ID ø 21.5mm thickness 1.3mm		

PTFE gaskets			
			
1			
Part No.	526094	Ref. No.	403081
description	flat gasket PTFE ED ø 17.3mm ID ø 12.2mm thickness 2.3mm Qty 1 pcs		
For models:	Classica-SA, Club, XeosEvolution2		

			
1			
Part No.	526095	Ref. No.	408714
description	flat gasket PTFE ED ø 39.6mm ID ø 34.4mm thickness 2.9mm Qty 1 pcs		
For models:	Club, XeosEvolution2		

			
1			
Part No.	526096	Ref. No.	410619
description	flat gasket PTFE ED ø 63.7mm ID ø 57.7mm thickness 2.5mm Qty 1 pcs		
For models:	TwinStar2		

			
1			
Part No.	526097	Ref. No.	407709
description	flat gasket PTFE ED ø 75.8mm ID ø 68.4mm thickness 3.2mm Qty 1 pcs		
For models:	Classica-PM, Classica-SA, Club, XeosEvolution2		

special gaskets

group gaskets

			
1			
Part No.	528465	Ref. No.	N/A
description	gasket D1 ø 42.5mm thickness 2mm suitable for CONTI		

			
1			
Part No.	528464	Ref. No.	N/A
description	group gasket D1 ø 90mm D2 ø 49mm thickness 2mm suitable for CONTI		

springs

compression springs

			
1			
Part No.	526087	Ref. No.	410635
description	compression spring ø 10.7mm L 14.5mm wire gauge ø 0.7mm		
For models:	TwinStar2, XeosEvolution2		

			
1			
Part No.	526088	Ref. No.	400012
description	compression spring ø 12.7mm L 31.4mm wire gauge ø 1.4mm		
For models:	Classica-PM, Classica-SA, TwinStar2, XeosEvolution2		

			
1			
Part No.	526089	Ref. No.	403474
description	compression spring ø 4.9mm L 17mm wire gauge ø 0.3mm		
For models:	Club, TwinStar2		





manometers

			
1			
Part No.	541262	Ref. No.	425013
description	manometer double scale ø 63mm pressure range 0-3 / 0-15bar connection on the backside thread 1/8"		

			
1			
Part No.	541702	Ref. No.	4115042
description	manometer ø 40mm pressure range 0-2.5bar thread 1/8" marking 0.5-1.2 connection on the backside		

			
1			
Part No.	541705	Ref. No.	404325
description	manometer ø 62mm pressure range 0-3bar connection lower marking 0.5-0.8 thread 1/4"		
For models:	Classica-SA, Club		

			
1			
Part No.	541703	Ref. No.	4077101
description	manometer ø 63mm pressure range 0-2.5 / 0-16bar connection on the backside thread 1/8" pipe		

			
1			
Part No.	541704	Ref. No.	4108881
description	manometer ø 63mm pressure range 0-4 / 0-16bar connection on the backside thread 1/8" pipes		

fastening material

screws

hexagonal screws

			
1			
Part No.	560083	Ref. No.	401010
description	hexagonal screw thread M5 thread L 10mm SS WS 8 Qty 20 pcs DIN 933 / ISO 4017		
For models:	Classica-PM, Classica-SA, Club, TwinStar2, XeosEvolution2		

			
1			
Part No.	560385	Ref. No.	401012
description	hexagonal screw thread M5 thread L 12mm SS WS 8 Qty 1 pcs DIN 933 / ISO 4017		

cylinder head bolts

DIN 912/ISO 4762

			
1			
Part No.	560373	Ref. No.	401983
description	cylinder head bolt thread M4 thread L 12mm WS 3 SS Qty 1 pcs intake internal hexagon DIN 912/ISO 4762		
For models:	Classica-SA, Club, XeosEvolution2		

			
1			
Part No.	560402	Ref. No.	071600
description	cylinder head bolt thread M5 thread L 10mm L 15.5mm WS 4 SS Qty 1 pcs intake hexagonal DIN 912/ISO 4762		
For models:	Classica-SA, Club, TwinStar2, XeosEvolution2		

			
1			
Part No.	560033	Ref. No.	071100
description	cylinder head bolt thread M6 thread L 20mm WS 5 SS Qty 20 pcs DIN 912/ISO 4762		
For models:	Classica-SA, Club, TwinStar2, XeosEvolution2		

			
1			
Part No.	560225	Ref. No.	407016
description	cylinder head bolt thread M4 L 30mm thread L 20mm WS 3 intake hexagonal SS Qty 1 pcs head ø 7mm head thickness 4mm DIN 912/ISO 4762		
For models:	Classica-PM, Classica-SA, XeosEvolution2		



nuts

hexagonal nuts

hexagonal nuts metric (without norm)

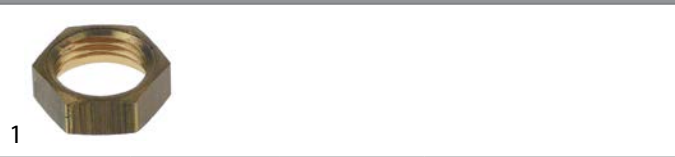

Part No.	507464	Ref. No.	402103
description	nut thread M16x1.5 H 7mm WS 19 brass Qty 1 pcs		
For models:	Classica-PM, Classica-SA, Club		

hexagonal nuts inch thread



Part No.	507463	Ref. No.	407775
description	nut thread 1/2" H 9.1mm WS 23 brass		
For models:	Classica-PM, Classica-SA, Club, XeosEvolution2		

washers

washers

miscellaneous



Part No.	528445	Ref. No.	233600
description	press ring D1 ø 18mm D2 ø 12.15mm thickness 3mm brass level glass		
For models:	Classica-PM, Classica-SA		

tooth lock washers

DIN 6798A

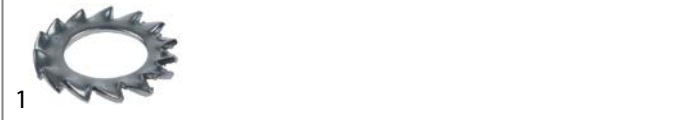

Part No.	503121	Ref. No.	173600
description	tooth lock washer ID ø 8.4mm ED ø 15mm SS Qty 1 pcs		

GASTROPARTS.COM

