



GASTROPARTS

Coldline

- [EN]** Equipment
- [DE]** Geräte
- [ES]** Aparatos
- [FR]** Équipement
- [IT]** Attrezzature
- [PL]** Urządzenia
- [RU]** Оборудование

✉ gastroparts@gastroparts.com

☎ tel. +48 56 657 00 66

📘 fb.com/gastroparts.global

GASTROPARTS.COM





heating elements

heating elements for refrigeration

heating elements for defrosting



Part No.	417515	Ref. No.	R030000600 R911015010
description	heating element 150W 230V L 630mm W 60mm Hmm cable length 1700mm tube ø 8.5mm		

heating elements for condensate evaporation



Part No.	420181	Ref. No.	R111050010
description	heating element 500W 230V L 480mm W 59mm cable length 800mm tube ø 8.4mm condensate evaporation		

switches and momentary switches

microswitches

lever actuated



Part No.	347683	Ref. No.	E912100110
description	microswitch with lever 250V 12A 1CO connection male faston 6.3mm L 46mm ambient temperature max. 85°C mounting distance 22mm type XGK15-88 actuating force: 25g lever length 32mm		

electronic controllers

DIXELL

refrigeration controllers

built-in version



Part No.	378461	Ref. No.	E020610420
description	electronic controller DIXELL XW30V-5N0C1-R mounting measurements 55x70mm built-in depth 65mm 230V voltage AC NTC/PTC relay outputs 3 NO-20A(8) NO-8A(3) NO-8A(3) NTC/PTC NTC/PTC DI protection IP65 -50 up to +150°C display 3½ digits		
accessories for	378461		
Part No.	379052	Ref. No.	—
description	temperature probe PTC 1kOhm cable silicone probe -50 up to +150°C cable -50 up to +180°C probe ø6x40mm cable length 1.5m without screw connection 2-wire		

accessories for	378461		
Part No.	379053	Ref. No.	—
description	temperature probe PTC 1kOhm cable PVC probe -50 up to +150°C cable -10 up to 100°C probe ø6x30mm cable length 3m without screw connection 2-wire		
Part No.	379064	Ref. No.	—
description	temperature probe PTC 1kOhm cable silicone probe -50 up to +150°C cable -50 up to +180°C probe ø6x40mm cable length 3m without screw connection 2-wire		
Part No.	379142	Ref. No.	—
description	temperature probe PTC 1kOhm cable PVC probe -50 up to +150°C cable -10 up to 100°C probe ø6x30mm cable length 1.5m without screw connection 2-wire		
Part No.	379160	Ref. No.	—
description	temperature probe NTC 10kOhm cable thermoplastic probe -40 up to +110°C cable -40 up to +110°C probe ø6x14mm cable length 1.5m without screw connection 2-wire		
Part No.	379161	Ref. No.	—
description	temperature probe NTC 10kOhm cable thermoplastic probe -40 up to +110°C cable -40 up to +110°C probe ø6x14mm cable length 3m without screw connection 2-wire		
Part No.	379162	Ref. No.	—
description	temperature probe NTC 10kOhm cable thermoplastic probe -40 up to +110°C cable -40 up to +110°C probe ø6x14mm cable length 6m 2-wire		
Part No.	379169	Ref. No.	—
description	temperature probe NTC 10kOhm cable thermoplastic probe -40 up to +110°C cable -40 up to +110°C probe ø6x14mm cable length 2m without screw connection 2-wire		
Part No.	379199	Ref. No.	—
description	temperature probe PTC 1kOhm cable PVC probe -50 up to +150°C cable -10 up to 100°C probe ø6x30mm cable length 5m without screw connection 2-wire		
Part No.	379343	Ref. No.	—
description	temperature probe NTC 10kOhm cable silicone probe -40 up to +110°C cable -50 up to +180°C probe ø6x40mm cable length 3m 2-wire		
Part No.	379458	Ref. No.	—
description	temperature probe NTC 10kOhm cable silicone probe -40 up to +110°C cable -50 up to +180°C probe ø6x40mm cable length 1.5m without screw connection 2-wire		
Part No.	379630	Ref. No.	—
description	temperature probe NTC 10kOhm cable thermoplastic probe -40 up to +110°C cable -40 up to +110°C probe ø6x14mm cable length 2.5m without screw connection 2-wire resistor 10kOhm		

Part No.	403533	Ref. No.	E020610410 E020610410 + E020650020
description	electronic controller DIXELL XW60L-5L0C0-R mounting measurements 150x30mm built-in depth 65.5mm 230V voltage AC NTC/PTC relay outputs 4 NO-20A(8) CO-8A(3) NO-8A(3) NO-16A(5) NTC/PTC NTC/PTC DI -50 up to +150°C display 3½ digits		



probes

producer-specific probes

probes



Part No.	379818	Ref. No.	E042651510
description	temperature probe PTC 1kOhm cable PVC probe -50 up to +150°C cable -10 up to 100°C connection 3-wire thread probe ø6x40mm cable length 1.5m		

core probes



Part No.	378407	Ref. No.	E043672510 E043673510 E200930030
description	core temperature probe PTC cable silicone probe -40 up to +120°C cable -50 up to +180°C connection 2-wire probe ø6/8x195mm thread cable length 3.5m handle ø 13mm handle length 130mm		

keypads

front foils

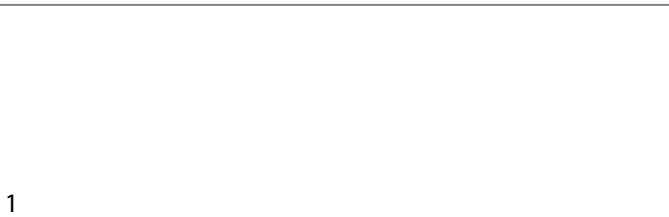

Part No.	403446	Ref. No.	E021041010
description	cover cap for blast chiller COLDLINE		

fans

refrigeration fans

cold air circulating fans (complete)

ebm-papst

A4E series

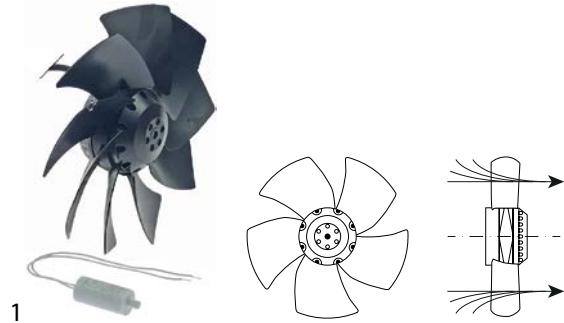

Part No.	602171	Ref. No.	F302125022
description	fan A4E250-AI02-10 fan wheel ø 250mm 230V blades 9 50/60Hz 42/45W 1400/1630rpm cable length 1500mm ebm-papst suitable capacitor 1.5µF		

hinges

spring assisted hinges

universal

INTERKLIMAT

hinges

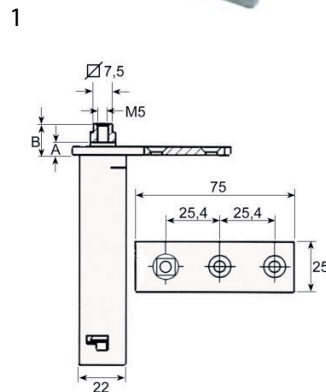

Part No.	690714	Ref. No.	5038447
description	spring assisted hinge series 28XC mounting pos. left/right L 75mm W 25mm H 103mm A 8mm B 11mm intake 7.5x7.5 refrigeration units mounting distance 25mm		



producer-specific

COLDLINE



1

Part No.	701128	Ref. No.	M121100020
description	spring assisted hinge L 75mm W 25mm H 103mm A 5mm B 13mm shaft length 9mm refrigeration units mounting distance 25.4mm mounting measurements 22x22x100mm intake 7.5x7.5		

EVERLASTING



1

Part No.	701128	Ref. No.	M121100020
description	spring assisted hinge L 75mm W 25mm H 103mm A 5mm B 13mm shaft length 9mm refrigeration units mounting distance 25.4mm mounting measurements 22x22x100mm intake 7.5x7.5		

gaskets

refrigeration gaskets

plug-in gaskets

profile 9048

We offer custom-made gaskets for this profile

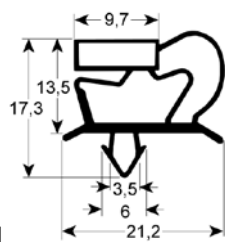

1

Part No.	902258	Ref. No.	N/A
description	refrigeration gasket profile 9048 Wmm L 2500mm		

profile 9794

We offer custom-made gaskets for this profile

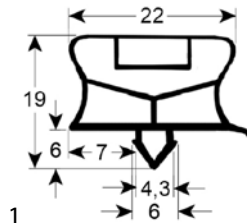

1

Part No.	901952	Ref. No.	G504330608
description	refrigeration gasket profile 9794 W 405mm L 580mm plug size		

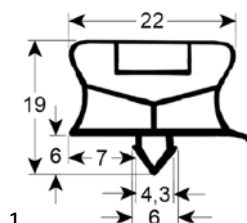

1

Part No.	901955	Ref. No.	G504330653
description	refrigeration gasket profile 9794 W 408mm L 630mm plug size L1 653mm W1 433mm external size		

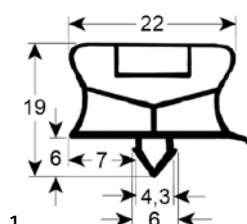

1

Part No.	901517	Ref. No.	G506581564
description	refrigeration gasket profile 9794 W 633mm L 1544mm plug size		

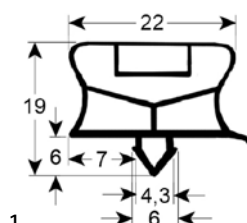

1

Part No.	901900	Ref. No.	G5065800739 Incastro G506580739
description	refrigeration gasket profile 9794 W 715mm L 635mm plug size		



profile 9195

We offer custom-made gaskets for this profile

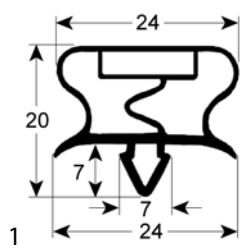

Part No.	901902	Ref. No.	G505080608
description	refrigeration gasket profile 9195 W 608mm L 508mm external size		

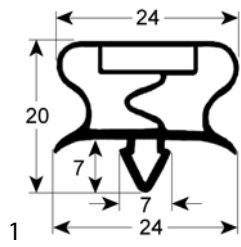

Part No.	901901	Ref. No.	G906580754
description	refrigeration gasket profile 9195 W 630mm L 725mm plug size		

evaporators

accessories

housings



Part No.	692676	Ref. No.	M620700020
description	cover for AL140/ME L 587mm W 475mm H 100mm		

GASTROPARTS.COM

