



**GASTROPARTS**

# Charvet

- [EN]** Equipment
- [DE]** Geräte
- [ES]** Aparatos
- [FR]** Équipement
- [IT]** Attrezzature
- [PL]** Urządzenia
- [RU]** Оборудование

✉ [gastroparts@gastroparts.com](mailto:gastroparts@gastroparts.com)

☎ tel. +48 56 657 00 66

📘 [fb.com/gastroparts.global](https://fb.com/gastroparts.global)

**GASTROPARTS.COM**





## heating elements

### heating elements for ovens

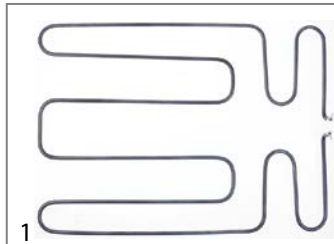

<b>Part No.</b>	420237	<b>Ref. No.</b>	02062A
<b>description</b>	heating element 2500W 230V L 600mm W 435mm H 29mm lug length 18mm lug width 7mm hole distance 50mm tube ø 8.5mm connection M4 heating circuits 1 dry heating element bracket mounting for oven		

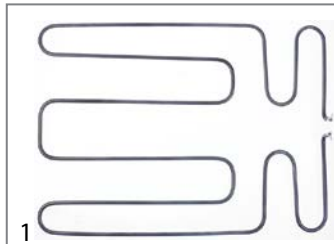

<b>Part No.</b>	420236	<b>Ref. No.</b>	02063A
<b>description</b>	heating element 2500W 400V L 600mm W 435mm H 29mm lug length 18mm lug width 7mm hole distance 50mm tube ø 8.5mm connection M4 heating circuits 1 dry heating element bracket mounting for oven		

### heating elements for bain maries



<b>Part No.</b>	420002	<b>Ref. No.</b>	03746A
<b>description</b>	heating element 2000W 230V heating circuits 1 L 383mm L1 20mm W 235mm connection M4 connection distance 225mm tube ø 8.5mm dry heating element bain marie L2 363mm H 15mm		

### heating elements for griddles



<b>Part No.</b>	420001	<b>Ref. No.</b>	03483A
<b>description</b>	heating element 1000W 230V heating circuits 1 L 405mm W 60mm Hmm tube ø 10mm 2 hole fixing connection M4 thread M14x1.25 mounting distance 45mm connection length 30mm dry heating element		







### heating elements for tilting bratt pan



<b>Part No.</b>	420555	<b>Ref. No.</b>	04448A
<b>description</b>	heating element 3000W 230V L 570mm W 90mm H 25mm connection screw connection heating circuits 1 tube ø 8mm		

<b>Part No.</b>	420233	<b>Ref. No.</b>	07668A
<b>description</b>	heating element 3300W 230V L 565mm W 84mm H 118mm connection M4 dry heating element heating circuits 1 tube ø 8.5mm		

### bottom heaters

<b>Part No.</b>	415661	<b>Ref. No.</b>	07369A	
<b>description</b>	bottom heater 3000W 230V heating circuits 2 ø 196mm safety thermostat 250°C thermostat 128°C M5 mounting distance 180mm			
<b>spare parts for</b>	415661			
	<b>Part No.</b>	102067	<b>Ref. No.</b>	—
	nut thread M8x1 H 3mm brass Qty 1 pcs type SEF 1			
	<b>Part No.</b>	375137	<b>Ref. No.</b>	—
	safety thermostat switch-off temp. 250°C 1-pole 16A probe ø 3.03mm probe L 160mm capillary pipe 880mm capillary pipe isolated 800mm gland nut probe SS with curved probe			
	<b>Part No.</b>	375300	<b>Ref. No.</b>	—
	thermostat t.max. 128°C temperature range 35-128°C 1-pole 1NO 16A probe ø 3.1mm probe L 174mm capillary pipe 880mm capillary pipe isolated 800mm gland nut shaft L 23mm shaft position lower rotation 270°			
<b>accessories for</b>	415661			
	<b>Part No.</b>	520323	<b>Ref. No.</b>	—
	gasket ID ø 160mm ED ø 200mm hole distance 90/180mm hole ø 7mm silicone for bottom heaters			
	<b>Part No.</b>	520324	<b>Ref. No.</b>	—
	counterflange ID ø 160mm ED ø 200mm hole distance 90/180mm hole ø 7mm SS for bottom heaters			
	<b>Part No.</b>	551083	<b>Ref. No.</b>	—
	cap for safety thermostat thread M8x1			

### heating rods

<b>Part No.</b>	418459	<b>Ref. No.</b>	02030A
<b>description</b>	heating element 1000W 240V connection M5 L 630mm W 38mm H 8mm hole distance 650mm hole ø 8mm		



			
1			
<b>Part No.</b>	420554	<b>Ref. No.</b>	504998
<b>description</b>	heating element 1250W 240V L 680mm W 40mm H 10mm cable length 470mm		

## immersion heating elements

			
1			
<b>Part No.</b>	420231	<b>Ref. No.</b>	03345A
<b>description</b>	heating element 3000W 230V heating circuits 1 L 665mm W 90mm tube ø 8.5mm connection M6 2 hole fixing for kettle thread M14x1.5		

			
1			
<b>Part No.</b>	420232	<b>Ref. No.</b>	03346A
<b>description</b>	heating element 3500W 230V heating circuits 1 L 665mm W 110mm Hmm tube ø 8mm connection M6 2 hole fixing thread M14x1.5		

## hot plates

## square &amp; rectangular

## with cast edge

## with screw connection

			
1			
<b>Part No.</b>	490078	<b>Ref. No.</b>	06048A
<b>description</b>	hot plate dimensions 300x300mm 3000W 400V with cast edge connection 4 screw clamps square		

## tiltable

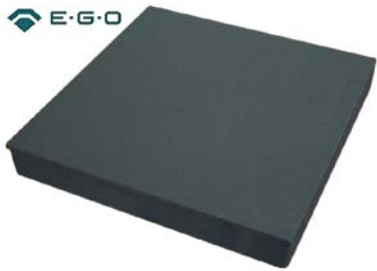
			
1			
<b>Part No.</b>	490090	<b>Ref. No.</b>	2078A
<b>description</b>	hot plate dimensions 300x300mm 4000W 400V with cast edge tilt boiling plate connection 4 screw clamps H 43mm square		

## energy regulators

## EGO

## 1-circuit

			
1			
<b>Part No.</b>	380015	<b>Ref. No.</b>	09099A
<b>description</b>	energy regulator 230V 13A single-circuit turn direction right shaft ø 6x4.6mm shaft L 23mm mounting thread M4 power release 6-100% no. 50.57021.010		



			
1			
<b>Part No.</b>	380013	<b>Ref. No.</b>	09088A
<b>description</b>	energy regulator 400V 7A single-circuit turn direction right shaft ø 6x4.6mm mounting thread M4 no. 50.57031.010		

## DIAMOND

			
1			
<b>Part No.</b>	380037	<b>Ref. No.</b>	02004A
<b>description</b>	energy regulator 240V 13.5A turn direction right shaft ø 6x4.6mm shaft L 13mm mounting thread 3/8"-24UNF equiv. no. 35ERE101230V		

			
1			
<b>Part No.</b>	380038	<b>Ref. No.</b>	2003A
<b>description</b>	energy regulator 24V 13.5A turn direction right shaft ø 6x4.6mm mounting thread 3/8"-24UNF equiv. no. 35ERE105024V voltage AC		



			
1			
<b>Part No.</b>	380039	<b>Ref. No.</b>	02005A 02006A
<b>description</b>	energy regulator 400V 13.5A turn direction right shaft ø 6x4.6mm mounting thread 3/8"-24UNF equiv. no. 35ERE104400V		
<b>accessories for</b>	380039		
		<b>Part No.</b>	361181
		<b>Ref. No.</b>	—
	nut thread 1/8" H 4.5mm nickel-plated brass WS 14 Qty 1 pcs		

			
1			
<b>Part No.</b>	375038	<b>Ref. No.</b>	01990A
<b>description</b>	thermostat t.max. 300°C temperature range 50-300°C 3-pole 3NO 16A probe ø 6mm probe L 79mm capillary pipe 1740mm capillary pipe isolated 800mm gland nut shaft ø 6x4.6mm shaft L 23mm shaft position upper rotation 270°		
<b>accessories for</b>	375038		
		<b>Part No.</b>	110123
		<b>Ref. No.</b>	—
	knob thermostat t.max. 300°C ø 50mm shaft ø 6x4.6mm shaft flat upper black temperature range 50-300°C rotation 270°		

## thermostats

### control and safety thermostats

			
1			
<b>Part No.</b>	375143	<b>Ref. No.</b>	1995A
<b>description</b>	thermostat t.max. 110°C temperature range 32-110°C 3-pole 3NO 16A probe ø 6mm probe L 138mm capillary pipe 1480mm capillary pipe isolated 1100mm gland nut M9x1 shaft ø 6x4.6mm shaft L 23mm shaft position upper rotation 270°		

			
1			
<b>Part No.</b>	375026	<b>Ref. No.</b>	01999a
<b>description</b>	thermostat t.max. 350°C temperature range 100-350°C 3-pole 3NO 16A probe ø 6mm probe L 77mm capillary pipe 2430mm capillary pipe isolated 1100mm gland nut shaft ø 6x4.6mm shaft L 23mm shaft position upper rotation 270°		

			
1			
<b>Part No.</b>	375020	<b>Ref. No.</b>	1995A
<b>description</b>	thermostat t.max. 110°C temperature range 32-110°C 3-pole capillary pipe isolatedmm gland nut		

			
1			
<b>Part No.</b>	390813	<b>Ref. No.</b>	40100080
<b>description</b>	safety thermostat switch-off temp. 245°C 3-pole 20A probe ø 6mm probe L 78mm capillary pipe 1500mm capillary pipe isolated 1050mm gland nut M9x1 probe		



55.33\_series



**Part No.** 375796 **Ref. No.** 02823A

**description** safety thermostat switch-off temp. 220°C 3-pole 3NC 20A probe ø 6mm probe L 107mm capillary pipe 870mm capillary pipe isolated 800mm gland nut probe



**Part No.** 390675 **Ref. No.** 05996A

**description** safety thermostat switch-off temp. 230°C 3-pole 20A probe ø 6mm probe L 88mm capillary pipe 2200mm capillary pipe isolatedmm gland nut probe

## switches and momentary switches

### microswitches

#### lever actuated



**Part No.** 345742 **Ref. No.** 07676A

**description** microswitch with lever 250V 16A 1CO connection male faston 6.3mm L 55mm ambient temperature max. 120°C mounting distance 22mm actuating force: 75g lever length 46mm



**Part No.** 345363 **Ref. No.** 07676A

**description** microswitch with lever 250V 16A 1CO connection male faston 6.3mm L 56mm ambient temperature max. 125°C



**Part No.** 345074 **Ref. No.** 08233A

**description** microswitch with lever 250V 16A 1CO connection male faston 6.3mm ambient temperature max. 85°C mounting distance 25mm type C99ZP3 actuating force: 25g lever length 154mm

#### roller-lever actuated

#### microswitches



**Part No.** 345041 **Ref. No.** 504985

**description** microswitch with handle with a switch 250V 16A 1CO connection male faston 6.3mm ambient temperature max. 85°C black lever length 20.5mm

#### heavy duty version



**Part No.** 347718 **Ref. No.** 07675A

**description** microswitch with handle with a switch 250V 16A 1CO connection screw L 36mm L1 39mm ambient temperature max. 85°C mounting distance 26mm type MS-42 actuating force: 50g lever length 51mm

### float switches

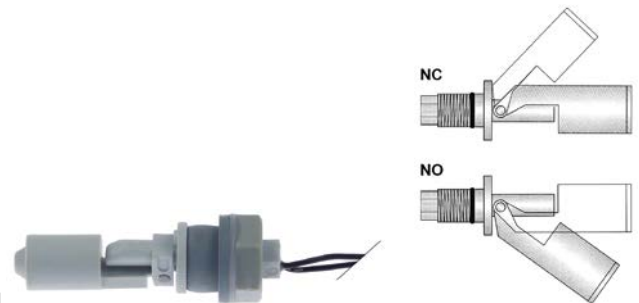

**Part No.** 347654 **Ref. No.** 07504A



**description** float switch thread M16x2 1NO or 1NC ø 17mm L 70mm mounting ø 16mmVA cable cable length 500mm



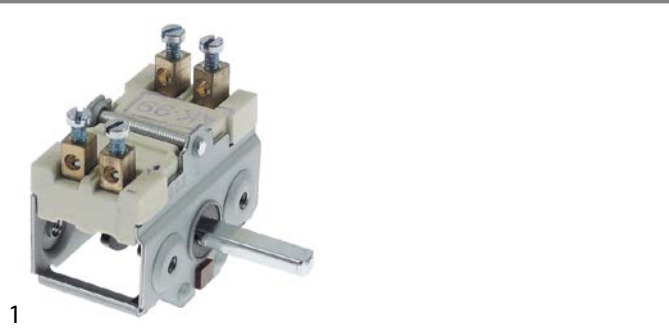

cam switches



on/off



1			
<b>Part No.</b>	300020	<b>Ref. No.</b>	ELE0085
<b>description</b>	cam switch 4 operating positions 2NO sequence 0-1-0-1 16A shaft ø 6x4.6mm shaft L 23mm connection screw ceramic		
<b>accessories for</b>	300020		
	<b>Part No.</b>	110135	<b>Ref. No.</b> —
	rosette knob up to ø 52mm		
	<b>Part No.</b>	110231	<b>Ref. No.</b> —
	knob switch 0-1-0-1 t.max.°C ø 50mm shaft ø 6x4.6mm shaft flat upper black		

			
1			
<b>Part No.</b>	300021	<b>Ref. No.</b>	ELE0083
<b>description</b>	cam switch 4 operating positions 4NO sequence 0-1-0-1 16A shaft ø 6x4.6mm shaft L 23mm connection screw ceramic		

4-position

			
1			
<b>Part No.</b>	300103	<b>Ref. No.</b>	02093A
<b>description</b>	cam switch 4 operating positions 1NO/2CO sequence 0-1-2-3 32A shaft ø 6x4.6mm shaft L 23mm connection screw ceramic		

control equipment

MAFELEC









switches (complete)

			
1			
<b>Part No.</b>	347743	<b>Ref. No.</b>	03967A
<b>description</b>	push button mounting measurements ø22mm 1NO 20A red complete		

rotary switches

			
1			
<b>Part No.</b>	347744	<b>Ref. No.</b>	02104A
<b>description</b>	rotary selector mounting measurements ø22mm 2NO black sequence 0-1 complete		

lamps

			
1			
<b>Part No.</b>	359607	<b>Ref. No.</b>	2835A
<b>description</b>	neon light bulb socket Ba9s 380V 2W clear ø 10mm L 28mm		
<b>accessories for</b>	359607		
	<b>Part No.</b>	359060	<b>Ref. No.</b> —
	lamp socket mounting measurements ø16.2mm socket E10 connection screw		
	<b>Part No.</b>	359063	<b>Ref. No.</b> —
	lamp socket mounting measurements ø19.2mm socket E14 connection screw		
	<b>Part No.</b>	359064	<b>Ref. No.</b> —
	lamp socket mounting measurements ø22.3mm socket E14 connection screw 250/380V ambient temperature at 1W 100°C ambient temperature at 2W 85°C		
	<b>Part No.</b>	359685	<b>Ref. No.</b> —
	lamp socket mounting measurements ø16.2mm socket E10		
	<b>Part No.</b>	359832	<b>Ref. No.</b> —
	lamp socket mounting measurements ø16.2mm socket Ba9s connection male faston 6.3mm		
	<b>Part No.</b>	359853	<b>Ref. No.</b> —
	lamp socket mounting measurements ø18.2mm socket Ba9s connection male faston 6.3mm		
	<b>Part No.</b>	359988	<b>Ref. No.</b> —
	lamp socket mounting measurements ø30.5mm 250V connection F6.3 temp.-resist. 55°C E14		





## lamps

## indicator lights



## indicator lights 3-piece (housing, lens and bulb)

## lamps

## neon light bulbs









1

<b>Part No.</b>	359585	<b>Ref. No.</b>	02141A
<b>description</b>	neon light bulb socket E10 230V green ø 10mm L 28mm		
<b>accessories for</b>	359585		
	<b>Part No.</b>	359060	<b>Ref. No.</b> —
	lamp socket mounting measurements ø16.2mm socket E10 connection screw		
	<b>Part No.</b>	359685	<b>Ref. No.</b> —
	lamp socket mounting measurements ø16.2mm socket E10		









1

<b>Part No.</b>	359607	<b>Ref. No.</b>	2835A
<b>description</b>	neon light bulb socket Ba9s 380V 2W clear ø 10mm L 28mm		
<b>accessories for</b>	359607		
	<b>Part No.</b>	359060	<b>Ref. No.</b> —
	lamp socket mounting measurements ø16.2mm socket E10 connection screw		
	<b>Part No.</b>	359063	<b>Ref. No.</b> —
	lamp socket mounting measurements ø19.2mm socket E14 connection screw		
	<b>Part No.</b>	359064	<b>Ref. No.</b> —
	lamp socket mounting measurements ø22.3mm socket E14 connection screw 250/380V ambient temperature at 1W 100°C ambient temperature at 2W 85°C		
	<b>Part No.</b>	359685	<b>Ref. No.</b> —
	lamp socket mounting measurements ø16.2mm socket E10		
	<b>Part No.</b>	359832	<b>Ref. No.</b> —
	lamp socket mounting measurements ø16.2mm socket Ba9s connection male faston 6.3mm		
	<b>Part No.</b>	359853	<b>Ref. No.</b> —
	lamp socket mounting measurements ø18.2mm socket Ba9s connection male faston 6.3mm		
	<b>Part No.</b>	359988	<b>Ref. No.</b> —
	lamp socket mounting measurements ø30.5mm 250V connection F6.3 temp.-resist. 55°C E14		



1

<b>Part No.</b>	359601	<b>Ref. No.</b>	02142A
<b>description</b>	neon light bulb socket E10 380V clear ø 10mm L 28mm glas		
<b>accessories for</b>	359601		
	<b>Part No.</b>	359060	<b>Ref. No.</b> —
	lamp socket mounting measurements ø16.2mm socket E10 connection screw		
	<b>Part No.</b>	359063	<b>Ref. No.</b> —
	lamp socket mounting measurements ø19.2mm socket E14 connection screw		
	<b>Part No.</b>	359064	<b>Ref. No.</b> —
	lamp socket mounting measurements ø22.3mm socket E14 connection screw 250/380V ambient temperature at 1W 100°C ambient temperature at 2W 85°C		
	<b>Part No.</b>	359685	<b>Ref. No.</b> —
	lamp socket mounting measurements ø16.2mm socket E10		
	<b>Part No.</b>	359832	<b>Ref. No.</b> —
	lamp socket mounting measurements ø16.2mm socket Ba9s connection male faston 6.3mm		
	<b>Part No.</b>	359853	<b>Ref. No.</b> —
	lamp socket mounting measurements ø18.2mm socket Ba9s connection male faston 6.3mm		
	<b>Part No.</b>	359988	<b>Ref. No.</b> —
	lamp socket mounting measurements ø30.5mm 250V connection F6.3 temp.-resist. 55°C E14		

## indicator lights (complete)

## ø12mm

## with screw socket



1

<b>Part No.</b>	359048	<b>Ref. No.</b>	07664A
<b>description</b>	indicator light ø 12mm 230V yellow connection male faston 6.3mm		



1

<b>Part No.</b>	359895	<b>Ref. No.</b>	07139A
<b>description</b>	indicator light ø 12mm 400V yellow connection cable 200mm		





1

<b>Part No.</b>	359894	<b>Ref. No.</b>	07136A
<b>description</b>	indicator light ø 12mm 400V red connection cable 200mm		











screw-on/push-on fit

neon light bulbs

			
1			
<b>Part No.</b>	359585	<b>Ref. No.</b>	02141A
<b>description</b>	neon light bulb socket E10 230V green ø 10mm L 28mm		
<b>accessories for</b>	359585		
	<b>Part No.</b>	359060	<b>Ref. No.</b> —
	lamp socket mounting measurements ø16.2mm socket E10 connection screw		
	<b>Part No.</b>	359685	<b>Ref. No.</b> —
	lamp socket mounting measurements ø16.2mm socket E10		

			
1			
<b>Part No.</b>	359607	<b>Ref. No.</b>	2835A
<b>description</b>	neon light bulb socket Ba9s 380V 2W clear ø 10mm L 28mm		
<b>accessories for</b>	359607		
	<b>Part No.</b>	359060	<b>Ref. No.</b> —
	lamp socket mounting measurements ø16.2mm socket E10 connection screw		
	<b>Part No.</b>	359063	<b>Ref. No.</b> —
	lamp socket mounting measurements ø19.2mm socket E14 connection screw		
	<b>Part No.</b>	359064	<b>Ref. No.</b> —
	lamp socket mounting measurements ø22.3mm socket E14 connection screw 250/380V ambient temperature at 1W 100°C ambient temperature at 2W 85°C		
	<b>Part No.</b>	359685	<b>Ref. No.</b> —
	lamp socket mounting measurements ø16.2mm socket E10		
	<b>Part No.</b>	359832	<b>Ref. No.</b> —
	lamp socket mounting measurements ø16.2mm socket Ba9s connection male faston 6.3mm		
	<b>Part No.</b>	359853	<b>Ref. No.</b> —
	lamp socket mounting measurements ø18.2mm socket Ba9s connection male faston 6.3mm		
	<b>Part No.</b>	359988	<b>Ref. No.</b> —
	lamp socket mounting measurements ø30.5mm 250V connection F6.3 temp.-resist. 55°C E14		

			
1			
<b>Part No.</b>	359601	<b>Ref. No.</b>	02142A
<b>description</b>	neon light bulb socket E10 380V clear ø 10mm L 28mm glas		
<b>accessories for</b>	359601		
	<b>Part No.</b>	359060	<b>Ref. No.</b> —
	lamp socket mounting measurements ø16.2mm socket E10 connection screw		
	<b>Part No.</b>	359063	<b>Ref. No.</b> —
	lamp socket mounting measurements ø19.2mm socket E14 connection screw		

<b>accessories for</b>	359601		
	<b>Part No.</b>	359064	<b>Ref. No.</b> —
	lamp socket mounting measurements ø22.3mm socket E14 connection screw 250/380V ambient temperature at 1W 100°C ambient temperature at 2W 85°C		
	<b>Part No.</b>	359685	<b>Ref. No.</b> —
	lamp socket mounting measurements ø16.2mm socket E10		
	<b>Part No.</b>	359832	<b>Ref. No.</b> —
	lamp socket mounting measurements ø16.2mm socket Ba9s connection male faston 6.3mm		
	<b>Part No.</b>	359853	<b>Ref. No.</b> —
	lamp socket mounting measurements ø18.2mm socket Ba9s connection male faston 6.3mm		
	<b>Part No.</b>	359988	<b>Ref. No.</b> —
	lamp socket mounting measurements ø30.5mm 250V connection F6.3 temp.-resist. 55°C E14		

timers

audible timers

			
1			
<b>Part No.</b>	350014	<b>Ref. No.</b>	02167A
<b>description</b>	audible timer operation time 15min ø 56mm shaft ø 6x4.6mm shaft L 24mm mounting distance 28mm		

			
1			
<b>Part No.</b>	350189	<b>Ref. No.</b>	02167A
<b>description</b>	audible timer operation time 15min ø 61mm shaft ø 6x4.6mm shaft L 24mm mounting distance 28.5mm		





## contactors

## ABB

## power contactors



1

<b>Part No.</b>	381011	<b>Ref. No.</b>	07679A
<b>description</b>	power contactor resistive load 16A 230VAC (AC3/400V) 9A/4kW main contacts 2NO/2NC auxiliary contacts connection screw connection type B6-22-00		



1

<b>Part No.</b>	380117	<b>Ref. No.</b>	07667A
<b>description</b>	power contactor resistive load 25A 230VAC (AC3/400V) 9A/4kW main contacts 4NO auxiliary contacts connection screw connection type A9-40-00		



1

<b>Part No.</b>	381122	<b>Ref. No.</b>	00080A
<b>description</b>	power contactor resistive load 25A 250-500V AC/DC (AC3/400V) 9A/4kW main contacts 3NO auxiliary contacts 1NO connection screw connection type AF09-30-10-14		

## relays

## power relays

## with bracket mounting



1

<b>Part No.</b>	380403	<b>Ref. No.</b>	07660A
<b>description</b>	power relays FINDER 230VAC 16A 3CO connection F6.3 bracket mounting manuf. no. 62.83.8.230.0500		



1

<b>Part No.</b>	380185	<b>Ref. No.</b>	07661A
<b>description</b>	power relays Italiana Relè 230VAC 30A 1NO connection F6.3 bracket mounting dimensions 36.5x32.2x51.8mm manuf. no. A10-230AC-FA		

## level relays

## miscellaneous



1

<b>Part No.</b>	380961	<b>Ref. No.</b>	02681A
<b>description</b>	level controller 1-pole 230V voltage AC type CNRVA1 FLT		

## probes

## producer-specific probes

## probes





1











<b>Part No.</b>	379824	<b>Ref. No.</b>	07666A
<b>description</b>	temperature probe thermocouple K (NiCr-Ni) cable Vetrotex probe -50 up to 1150°C cable -50 up to +350°C connection 2-wire thread probe ø4x65mm cable length 2.35m		





solenoid valves

solenoid valves (water)

ELBI			
straight			
			
Part No.	373017	Ref. No.	07662A
description	solenoid valve single straight 230VAC inlet 3/4" outlet 11.5mm DN10 ELBI		
spare parts for	373017		
	Part No.	370467	Ref. No. —
solenoid valve filter suitable for ELBI			

TP			
			
Part No.	370017	Ref. No.	07662A
description	solenoid valve single straight 230VAC inlet 3/4" outlet 11.5mm DN10 TP p max 10bar		
spare parts for	370017		
	Part No.	371013	Ref. No. —
solenoid coil TP 230VAC 50/60Hz			
accessories for	370017		
	Part No.	371220	Ref. No. —
reducer TP flow rate 3l/min red tolerance ±15%			
	Part No.	371221	Ref. No. —
reducer TP flow rate 5.5l/min yellow tolerance ±15%			
	Part No.	371222	Ref. No. —
reducer TP flow rate 6l/min grey tolerance ±15%			
	Part No.	371223	Ref. No. —
reducer TP flow rate 10l/min white tolerance ±15%			
	Part No.	371224	Ref. No. —
reducer TP flow rate 12l/min bronze tolerance ±15%			
	Part No.	371225	Ref. No. —
reducer TP flow rate 16l/min light brown tolerance ±15%			
	Part No.	371226	Ref. No. —
reducer TP flow rate 20l/min red tolerance ±15%			
	Part No.	371230	Ref. No. —
reducer TP flow rate 0.25l/min red tolerance ±25%			

accessories for	370017		
	Part No.	371231	Ref. No. —
reducer TP flow rate 0.35l/min violet tolerance ±25%			
	Part No.	371232	Ref. No. —
reducer TP flow rate 0.5l/min orange tolerance ±25%			
	Part No.	371233	Ref. No. —
reducer TP flow rate 0.8l/min white tolerance ±25%			
	Part No.	371234	Ref. No. —
reducer TP flow rate 1l/min light blue tolerance ±25%			
	Part No.	371235	Ref. No. —
reducer TP flow rate 1.2l/min brown tolerance ±25%			
	Part No.	371236	Ref. No. —
reducer TP flow rate 1.5l/min light brown tolerance ±25%			
	Part No.	371237	Ref. No. —
reducer TP flow rate 2.5l/min yellow tolerance ±25%			
	Part No.	371238	Ref. No. —
reducer TP flow rate 3.4l/min dark green tolerance ±25%			
	Part No.	371239	Ref. No. —
reducer TP flow rate 5l/min black tolerance ±25%			
	Part No.	371240	Ref. No. —
reducer TP flow rate 8l/min blue tolerance ±20%			

metal			
SIRAI			
solenoid valves steam (water)			
2-way			
L153-D series			
			
Part No.	370326	Ref. No.	—
description	solenoid valve 2-ways 230VAC connection 1" L 105mm DN 22mm slide-on receptacle DIN -10 up to 140°C SIRAI type series L153-D coil type Z914A membranes EPDM (steam/water) p max 8bar p min 0.1bar		
spare parts for	370326		
	Part No.	371161	Ref. No. —
solenoid coil 230VAC 27VA SIRAI coil type Z923A seat ø 16mm 50Hz			



## solenoid valves (refrigeration)

CASTEL

spare parts and accessories



<b>Part No.</b>	371090	<b>Ref. No.</b>	—
<b>description</b>	power socket plug type DIN 43650A screw		

## pressure switches

for gas equipment



<b>Part No.</b>	541051	<b>Ref. No.</b>	07835A
<b>description</b>	pressure control ø 45mm pressure range adjustable 10-50mbar pressure connection vertical gas technology connection 1/4" pressure connection ø 1/4"mm		

for steam control



<b>Part No.</b>	541769	<b>Ref. No.</b>	07399A
<b>description</b>	pressure control ø 45mm kettle pressure range up to 1.0bar connection 1/4" 250V 8A p max 1bar pressure connection 1/4"		



<b>Part No.</b>	541074	<b>Ref. No.</b>	08030A
<b>description</b>	pressure control ø 45mm triggering pressure 0.5bar reset pressure 0.35bar pressure connection vertical steam control pressure range 0.35/0.51bar connection 1/8" pressure connection 1/8"		

## electric accessories

cables

copper wire

up to 280°C



<b>Part No.</b>	550588	<b>Ref. No.</b>	02356A
<b>description</b>	copper wire 6mm <sup>2</sup> permanent temperature -60 up to +280°C conductor nickel-plated copper wire insulation glass fibre braiding/silicone rubber Qty 10m brown t.max. 350°C rated 300/500V test voltage 2000V		

nickel wire

up to 350°C



<b>Part No.</b>	550089	<b>Ref. No.</b>	02353A 02361A
<b>description</b>	nickel wire 4mm <sup>2</sup> brown Qty 10m permanent temperature -60 up to +350°C t.max. 400°C rated 300/500V test voltage 2000V conductor nickel wire insulation glass fibre braiding/silicone rubber		



<b>Part No.</b>	550590	<b>Ref. No.</b>	02356A 02364A
<b>description</b>	nickel wire 6mm <sup>2</sup> brown Qty 10m permanent temperature -60 up to +350°C t.max. 400°C rated 300/500V test voltage 2000V conductor nickel wire insulation glass fibre braiding/silicone rubber		

accessories

protection hoses





<b>Part No.</b>	550035	<b>Ref. No.</b>	02385A
<b>description</b>	protective metal tube PG21 ID ø 23mm ED ø 27mm zinc-coated steel Qty 10m		
<b>accessories for</b>	550035		



<b>Part No.</b>	550308	<b>Ref. No.</b>	—
<b>description</b>	screw connection for protection hose PG21 ID ø 21.7mm ED ømm nickel-plated brass Qty 5 pieces		













cable glands			
threaded cable glands			
screw connections			
			
1			
<b>Part No.</b>	550571	<b>Ref. No.</b>	02404A
<b>description</b>	cable gland thread PG16 cable ø 12.0-14.0mm mounting ø 21.5mm nickel-plated brass Qty 1 pcs		

fastening nuts			
			
1			
<b>Part No.</b>	550577	<b>Ref. No.</b>	02407A
<b>description</b>	nut thread PG16 H 3mm WS 26 nickel-plated brass Qty 1 pcs mounting ømm cable ømm		

## gas taps

### PEL

20S series				
				
1				
<b>Part No.</b>	101491	<b>Ref. No.</b>	08369A	
<b>description</b>	gas tap PEL type 20S gas inlet M16x1.5 (tube ø 10mm) bypass nozzle ø 0.35mm gas outlet M16x1.5 (tube ø 10/8mm) thermocouple connection M9x1 pilot connection shaft ø 8x6.5mm shaft L 22/15mm shaft flat lower			
<b>spare parts for</b>	101491			
	<b>Part No.</b>	100408	<b>Ref. No.</b>	—
	bypass nozzle type PEL20/21 bore ø 0.35mm thread M5x0.5			
	<b>Part No.</b>	101060	<b>Ref. No.</b>	00366A
	magnet unit standard L 39mm D1 ø 15.4mm D2 ø 11mm suitable for PEL20-21/JUNKERS/EGA			
	<b>Part No.</b>	101205	<b>Ref. No.</b>	—
	gas tap front part shaft ø 8x6.5mm shaft L 22/15mm shaft flat upper/lower suitable for PEL20			
	<b>Part No.</b>	101231	<b>Ref. No.</b>	—
	thermocouple nut T1: M9x1 T2: M18x1			
<b>accessories for</b>	101491			
	<b>Part No.</b>	101287	<b>Ref. No.</b>	—
	olive for pipe ø 6mm Qty 1 pcs			
	<b>Part No.</b>	101300	<b>Ref. No.</b>	—
	union nut thread M16x1.5 tube ø 10mm			
	<b>Part No.</b>	101450	<b>Ref. No.</b>	—
	olive for pipe ø 8mm L 12.7mm Qty 1 pcs ED ø 10mm			

<b>accessories for</b>	101491			
	<b>Part No.</b>	101451	<b>Ref. No.</b>	—
	union nut thread M16x1.5 tube ø 8mm			
	<b>Part No.</b>	110081	<b>Ref. No.</b>	—
	knob ø 70mm shaft ø 8x6.5mm shaft flat universal			
	<b>Part No.</b>	110083	<b>Ref. No.</b>	—
	knob dial plate gas tap without ignition flame silver			















21S series				
				
1				
<b>Part No.</b>	101095	<b>Ref. No.</b>	08366A	
<b>description</b>	gas tap PEL type 21S gas inlet M16x1.5 (tube ø 10mm) bypass nozzle ø 0.35mm gas outlet M16x1.5 (tube ø 10/8mm) thermocouple connection M8x1 pilot connection M10x1 shaft ø 8x6.5mm shaft L 22/15mm shaft flat lower			
<b>spare parts for</b>	101095			
	<b>Part No.</b>	100408	<b>Ref. No.</b>	—
	bypass nozzle type PEL20/21 bore ø 0.35mm thread M5x0.5			
	<b>Part No.</b>	101060	<b>Ref. No.</b>	00366A
	magnet unit standard L 39mm D1 ø 15.4mm D2 ø 11mm suitable for PEL20-21/JUNKERS/EGA			
	<b>Part No.</b>	101206	<b>Ref. No.</b>	—
	gas tap front part shaft ø 8x6.5mm shaft L 22/15mm shaft flat upper/lower suitable for PEL21			
	<b>Part No.</b>	101230	<b>Ref. No.</b>	—
	thermocouple nut T1: M8x1 T2: M18x1 aluminium			
<b>accessories for</b>	101095			
	<b>Part No.</b>	100908	<b>Ref. No.</b>	—
	union screw thread M10x1 for pipe ø 4mm Qty 1 pcs			
	<b>Part No.</b>	100909	<b>Ref. No.</b>	07011A
	union screw thread M10x1 for pipe ø 6mm Qty 1 pcs			
	<b>Part No.</b>	101246	<b>Ref. No.</b>	—
	olive for pipe ø 4mm Qty 1 pcs			
	<b>Part No.</b>	101278	<b>Ref. No.</b>	—
	olive for pipe ø 10mm Qty 1 pcs			
	<b>Part No.</b>	101286	<b>Ref. No.</b>	05377A
	olive ID ø 6mm Qty 1 pcs			
	<b>Part No.</b>	101300	<b>Ref. No.</b>	—
	union nut thread M16x1.5 tube ø 10mm			
	<b>Part No.</b>	101450	<b>Ref. No.</b>	—
	olive for pipe ø 8mm L 12.7mm Qty 1 pcs ED ø 10mm			











Table continues overleaf





accessories for		101095	
	Part No.	101451	Ref. No. —
	union nut thread M16x1.5 tube ø 8mm		
	Part No.	110081	Ref. No. —
	knob ø 70mm shaft ø 8x6.5mm shaft flat universal		
	Part No.	112206	Ref. No. —
	knob dial plate silver gas tap PEL21/22/23 t.max.°C ED ø 63mm ID ø 45.5mm		

## 22N/O series



<b>Part No.</b>	101443	<b>Ref. No.</b>	00310A
<b>description</b>	gas tap PEL type 22N/O gas inlet M20x1.5 (tube ø 12mm) bypass nozzle ø 0.35mm gas outlet M20x1.5 (tube ø 12/10mm) thermocouple connection pilot connection M10x1 shaft ø 10x8mm shaft L 25/17mm shaft flat lower		
<b>spare parts for</b>	101443		
	Part No.	100259	Ref. No. —
	bypass nozzle type PEL22 bore ø 0.35mm thread M6x0.5		
	Part No.	101201	Ref. No. —
	gas tap front part shaft ø 10x8mm shaft L 25/17mm shaft flat upper/lower suitable for PEL22		
	Part No.	101240	Ref. No. —
	gas connection thread M20x1.5 tube ø 12/10mm for PEL gas taps with gasket and screws horizontal		
	Part No.	101460	Ref. No. —
	O-ring ø 12.37mm D1 ø 2.62mm suitable for PEL22		
	Part No.	101461	Ref. No. —
	screw kit suitable for PEL22 Qty 4 pcs		
<b>accessories for</b>	101443		
	Part No.	100908	Ref. No. —
	union screw thread M10x1 for pipe ø 4mm Qty 1 pcs		
	Part No.	100909	Ref. No. 07011A
	union screw thread M10x1 for pipe ø 6mm Qty 1 pcs		
	Part No.	101246	Ref. No. —
	olive for pipe ø 4mm Qty 1 pcs		
	Part No.	101248	Ref. No. 07475A
	olive for pipe ø 12mm Qty 1 pcs suitable for PEL		
	Part No.	101249	Ref. No. 01600A
	olive for pipe ø 10mm Qty 1 pcs		
	Part No.	101250	Ref. No. 07463A
	union nut thread M20x1.5 for pipe ø 10mm		

accessories for		101443	
	Part No.	101251	Ref. No. 07462A
	union nut thread M20x1.5 for pipe ø 12mm		
	Part No.	101286	Ref. No. 05377A
	olive ID ø 6mm Qty 1 pcs		

## 22S/O series

























<b>Part No.</b>	101086	<b>Ref. No.</b>	06635A
<b>description</b>	gas tap PEL type 22S/O gas inlet M20x1.5 (tube ø 12mm) bypass nozzle ø 0.35mm gas outlet M20x1.5 (tube ø 12/10mm) thermocouple connection M9x1 pilot connection M10x1 shaft ø 10x8mm shaft L 25/17mm shaft flat lower		
<b>spare parts for</b>	101086		
	Part No.	100259	Ref. No. —
	bypass nozzle type PEL22 bore ø 0.35mm thread M6x0.5		
	Part No.	101058	Ref. No. 00325A
	magnet unit L 39mm D1 ø 15.4mm D2 ø 13.5mm suitable for PEL22/EGA24197 standard		
	Part No.	101201	Ref. No. —
	gas tap front part shaft ø 10x8mm shaft L 25/17mm shaft flat upper/lower suitable for PEL22		
	Part No.	101231	Ref. No. —
	thermocouple nut T1: M9x1 T2: M18x1		
	Part No.	101240	Ref. No. —
	gas connection thread M20x1.5 tube ø 12/10mm for PEL gas taps with gasket and screws horizontal		
	Part No.	101460	Ref. No. —
	O-ring ø 12.37mm D1 ø 2.62mm suitable for PEL22		
	Part No.	101461	Ref. No. —
	screw kit suitable for PEL22 Qty 4 pcs		
<b>accessories for</b>	101086		
	Part No.	100908	Ref. No. —
	union screw thread M10x1 for pipe ø 4mm Qty 1 pcs		
	Part No.	100909	Ref. No. 07011A
	union screw thread M10x1 for pipe ø 6mm Qty 1 pcs		
	Part No.	101241	Ref. No. —
	gas connection thread M20x1.5 tube ø 12/10mm for PEL gas taps vertical		
	Part No.	101246	Ref. No. —
	olive for pipe ø 4mm Qty 1 pcs		
	Part No.	101248	Ref. No. 07475A
	olive for pipe ø 12mm Qty 1 pcs suitable for PEL		
	Part No.	101249	Ref. No. 01600A
	olive for pipe ø 10mm Qty 1 pcs		





Table continues overleaf





accessories for		101086		
	Part No.	101250	Ref. No.	07463A
	union nut thread M20x1.5 for pipe ø 10mm			
	Part No.	101251	Ref. No.	07462A
	union nut thread M20x1.5 for pipe ø 12mm			
	Part No.	101286	Ref. No.	05377A
	olive ID ø 6mm Qty 1 pcs			
	Part No.	110080	Ref. No.	—
	knob ø 70mm shaft ø 10x8mm shaft flat universal			
	Part No.	112206	Ref. No.	—
	knob dial plate silver gas tap PEL21/22/23 t.max.°C ED ø 63mm ID ø 45.5mm			

accessories for		101949		
	Part No.	101250	Ref. No.	07463A
	union nut thread M20x1.5 for pipe ø 10mm			
	Part No.	101251	Ref. No.	07462A
	union nut thread M20x1.5 for pipe ø 12mm			
	Part No.	101286	Ref. No.	05377A
	olive ID ø 6mm Qty 1 pcs			
	Part No.	110080	Ref. No.	—
	knob ø 70mm shaft ø 10x8mm shaft flat universal			
	Part No.	112206	Ref. No.	—
	knob dial plate silver gas tap PEL21/22/23 t.max.°C ED ø 63mm ID ø 45.5mm			

				
1				
Part No.	101949	Ref. No.	00311A	
description	gas tap PEL type 22S/O gas inlet M20x1.5 (tube ø 12mm) bypass nozzle ø 0mm gas outlet M20x1.5 (tube ø 12/10mm) thermocouple connection M9x1 pilot connection M10x1 shaft ø 10x8mm shaft L 25/17mm shaft flat lower			
spare parts for	101949			
	Part No.	101058	Ref. No.	00325A
	magnet unit L 39mm D1 ø 15.4mm D2 ø 13.5mm suitable for PEL22/ EGA24197 standard			
	Part No.	101231	Ref. No.	—
	thermocouple nut T1: M9x1 T2: M18x1			
	Part No.	101235	Ref. No.	—
	gas connection thread M20x1.5 tube ø 12/10mm for PEL gas taps horizontal			
	Part No.	101460	Ref. No.	—
	O-ring ø 12.37mm D1 ø 2.62mm suitable for PEL22			
	Part No.	101461	Ref. No.	—
	screw kit suitable for PEL22 Qty 4 pcs			
accessories for	101949			
	Part No.	100908	Ref. No.	—
	union screw thread M10x1 for pipe ø 4mm Qty 1 pcs			
	Part No.	100909	Ref. No.	07011A
	union screw thread M10x1 for pipe ø 6mm Qty 1 pcs			
	Part No.	101246	Ref. No.	—
	olive for pipe ø 4mm Qty 1 pcs			
	Part No.	101248	Ref. No.	07475A
	olive for pipe ø 12mm Qty 1 pcs suitable for PEL			
	Part No.	101249	Ref. No.	01600A
	olive for pipe ø 10mm Qty 1 pcs			

















23S/O series				
				
1				
Part No.	101091	Ref. No.	00312A	
description	gas tap PEL type 23S/O gas inlet M28x1.5 (tube ø 20mm) bypass nozzle ø 0.35mm gas outlet M24x1.5 (tube ø 16mm) thermocouple connection M9x1 pilot connection M10x1 shaft ø 10x8mm shaft L 35/19mm shaft flat upper			
spare parts for	101091			
	Part No.	100455	Ref. No.	—
	bypass nozzle type PEL23/24 bore ø 0.35mm thread M8x0.5			
	Part No.	101045	Ref. No.	00394A
	magnet unit T1: M9x1 T2: M22x1 L 46mm ø 18mm suitable for PEL23S M9x1			
	Part No.	101244	Ref. No.	—
	gas connection thread M24x1.5 tube ø 12/16mm horizontal for PEL gas taps			
	Part No.	101336	Ref. No.	—
	gas tap front part shaft ø 10x8mm shaft L 35/17mm shaft flat upper/lower suitable for PEL23S			
	Part No.	101463	Ref. No.	—
	screw suitable for PEL23S Qty 4 pcs			
	Part No.	528455	Ref. No.	—
	O-ring Viton thickness 2.62mm ID ø 18.72mm Qty 1 pcs			
accessories for	101091			
	Part No.	100908	Ref. No.	—
	union screw thread M10x1 for pipe ø 4mm Qty 1 pcs			
	Part No.	100909	Ref. No.	07011A
	union screw thread M10x1 for pipe ø 6mm Qty 1 pcs			
	Part No.	101246	Ref. No.	—
	olive for pipe ø 4mm Qty 1 pcs			





Table continues overleaf







accessories for		101091		
Part No.		101252	Ref. No.	—
	union nut thread M24x1.5 for pipe ø 12mm			
	union nut thread M24x1.5 PEL for pipe ø 16mm			
	union nut thread M28x1.5 tube ø 20mm			
	olive for pipe ø 12mm Qty 1 pcs			
	olive for pipe ø 16mm Qty 1 pcs			
	olive for pipe ø 20mm Qty 1 pcs			
	olive ID ø 6mm Qty 1 pcs			05377A
	knob ø 70mm shaft ø 10x8mm shaft flat universal			
	knob dial plate silver gas tap PEL21/22/23 t.max.°C ED ø 63mm ID ø 45.5mm			

PEL 355

				
1				
Part No.	107227	Ref. No.	08425A	
description	gas tap PEL type 355 gas inlet M20x1.5 (tube ø 12mm) bypass nozzle ø 0mm gas outlet M20x1.5 (tube ø 12/10mm) thermocouple connection M9x1 pilot connection M10x1 shaft ø 10x8mm shaft L 27/17mm shaft flat left			
spare parts for	107227			
	Part No.	106819	Ref. No.	—
	solenoid valve body			
	Part No.	371090	Ref. No.	—
	power socket plug type DIN 43650A screw			
	Part No.	371157	Ref. No.	—
	solenoid coil t.max. 125°C 230V seat ø 13mm 17VA			

STN3R



				
1				
Part No.	106185	Ref. No.	00273A	
description	gas tap STN3R gas inlet pipe flange ø20mm bypass nozzle ø 0mm gas outlet 3/8" (tube ø 12mm) thermocouple connection M9x1 pilot connection M10x1 shaft ø 7x7mm shaft L 22/6mm shaft flat horizontal			
spare parts for	106185			
	Part No.	101964	Ref. No.	—
	clamping bracket			

				
1				
Part No.	103108	Ref. No.	00549A 05071A	
description	gas tap STN3R type 300 gas inlet 1/2" IT bypass nozzle ø 0mm gas outlet 1/2" IT thermocouple connection M9x1 pilot connection M10x1 shaft ø 10x8mm shaft L 36/19mm shaft flat lower with accessories incl. adapt. M28x1.5 (tube ø20mm)			

gas thermostats

SIT

710 Minisit series

				
1				
Part No.	106931	Ref. No.	00308A	
description	gas thermostat SIT type MINISIT 710 t.max. 310°C 70-310°C gas inlet 1/2" gas outlet 3/8" thermocouple connection M9x1 pilot connection M10x1 probe ø 4mm probe L 72mm capillary pipe 1300mm pressure controller no pressure regulator bar gland nut 0710647 ignition gas 6mm probe material stainless steel			
accessories for	106931			
	Part No.	101137	Ref. No.	—
	cover cap without piezoelectric igniter			
	Part No.	110068	Ref. No.	—
	knob suitable for Minisit ø 37mm			



<b>Part No.</b>	101131	<b>Ref. No.</b>	00306A
<b>description</b>	gas thermostat without cap, button and angle SIT type MINISIT 710 t.max. 190°C 50-190°C gas inlet 1/2" gas outlet 3/8" thermocouple connection M9x1 pilot connection M10x1 probe ø 5mm probe L 98mm capillary pipe 1200mm probe type type A2 pressure controller no pressure regulator bar gland nut		
<b>spare parts for</b>	101131		
	<b>Part No.</b>	101053	<b>Ref. No.</b> —
	magnet unit T1: M9x1 T2: M24x1 L 45mm ø 17mm suitable for Minisit		
	<b>Part No.</b>	102103	<b>Ref. No.</b> —
	probe 60-200°C probe ø 5mm probe L 98mm capillary pipe 1050mm t.max. 200°C fryer probe type type A2 suitable for MINISIT 710		
<b>accessories for</b>	101131		
	<b>Part No.</b>	100809	<b>Ref. No.</b> —
	O-ring EPDM thickness 2mm ID ø 21mm Qty 1 pcs		
	<b>Part No.</b>	100820	<b>Ref. No.</b> —
	gland duct ET M14x1.5 IT M10x0.75 probe ø max. 6.5mm WS 22		
	<b>Part No.</b>	100904	<b>Ref. No.</b> —
	locking screw M10x1 for pipe ø 4mm Qty 1 pcs		
	<b>Part No.</b>	100905	<b>Ref. No.</b> —
	locking screw M10x1 for pipe ø 6mm Qty 1 pcs		
	<b>Part No.</b>	101054	<b>Ref. No.</b> —
	magnet unit T1: M10x1 T2: M24x1 L 45mm ø 17mm suitable for Minisit		
	<b>Part No.</b>	101136	<b>Ref. No.</b> —
	piezoelectric igniter suitable for Minisit with cover cap ømm connection F6.3x0.8		
	<b>Part No.</b>	101137	<b>Ref. No.</b> —
	cover cap without piezoelectric igniter		
	<b>Part No.</b>	101267	<b>Ref. No.</b> —
	reducer IT 3/8" ET 1/2" L 21mm		
	<b>Part No.</b>	101268	<b>Ref. No.</b> —
	gas connection thread 3/8" angled with O-ring MINISIT 710		
	<b>Part No.</b>	101269	<b>Ref. No.</b> 00442A
	gas connection thread 1/2" angled with O-ring MINISIT 710		
	<b>Part No.</b>	101270	<b>Ref. No.</b> —
	screw connection IT 3/8" ET 3/8" L 28mm		
	<b>Part No.</b>	101272	<b>Ref. No.</b> —
	screw connection IT 1/2" ET 3/8" L 57mm		
	<b>Part No.</b>	101273	<b>Ref. No.</b> —
	olive for pipe ø 12mm L 9.5mm brass Qty 1 pcs suitable for universal		

<b>accessories for</b>	101131		
	<b>Part No.</b>	101274	<b>Ref. No.</b> —
	olive for pipe ø 16mm Qty 1 pcs		
	<b>Part No.</b>	101275	<b>Ref. No.</b> —
	union screw thread 1/2" for pipe ø 16mm Qty 1 pcs		
	<b>Part No.</b>	101276	<b>Ref. No.</b> —
	union screw thread 3/8" tube ø 12mm Qty 1 pcs		
	<b>Part No.</b>	110068	<b>Ref. No.</b> —
	knob suitable for Minisit ø 37mm		

<b>Part No.</b>	107237	<b>Ref. No.</b>	00306A
<b>description</b>	gas thermostat without cap, button and angle SIT type MINISIT 710 t.max. 210°C 70-210°C gas inlet 1/2" gas outlet 3/8" thermocouple connection M9x1 pilot connection M10x1 probe ø 4mm probe L 122mm capillary pipe 1300mm probe type pressure controller no pressure regulator bar gland nut		
<b>accessories for</b>	107237		
	<b>Part No.</b>	101137	<b>Ref. No.</b> —
	cover cap without piezoelectric igniter		
	<b>Part No.</b>	101267	<b>Ref. No.</b> —
	reducer IT 3/8" ET 1/2" L 21mm		
	<b>Part No.</b>	101268	<b>Ref. No.</b> —
	gas connection thread 3/8" angled with O-ring MINISIT 710		
	<b>Part No.</b>	110068	<b>Ref. No.</b> —
	knob suitable for Minisit ø 37mm		

PEL

24STS series



<b>Part No.</b>	107228	<b>Ref. No.</b>	00473A
<b>description</b>	gas thermostat PEL type 24STS 110-310°C gas inlet flange bypass nozzle ø 1.1mm gas outlet flange thermocouple connection M9x1 pilot connection M10x1 capillary pipe 1200mm probe ø 6mm probe L 100mm shaft ø 10x8mm shaft L 27/17mm shaft flat upper		





			
<b>1</b>			
<b>Part No.</b>	101159	<b>Ref. No.</b>	473A
<b>description</b>	gas thermostat PEL type 24STS 120-320°C gas inlet flange bypass nozzle ø 0.35mm gas outlet flange thermocouple connection M9x1 pilot connection M10x1 capillary pipe 1200mm probe ø 6mm probe L 100mm shaft ø 10x8mm shaft L 27/17mm shaft flat upper		
<b>spare parts for</b>	101159		
	<b>Part No.</b>	100455	<b>Ref. No.</b> —
	bypass nozzle type PEL23/24 bore ø 0.35mm thread M8x0.5		
	<b>Part No.</b>	101058	<b>Ref. No.</b> 00325A
	magnet unit L 39mm D1 ø 15.4mm D2 ø 13.5mm suitable for PEL22/ EGA24197 standard		
	<b>Part No.</b>	106200	<b>Ref. No.</b> —
	nut thread M9x1 suitable for PEL 24/25S		
<b>accessories for</b>	101159		
	<b>Part No.</b>	101235	<b>Ref. No.</b> —
	gas connection thread M20x1.5 tube ø 12/10mm for PEL gas taps horizontal		
	<b>Part No.</b>	101236	<b>Ref. No.</b> —
	gas connection thread M20x1.5 tube ø 12/10mm for PEL gas taps vertical		
	<b>Part No.</b>	101240	<b>Ref. No.</b> —
	gas connection thread M20x1.5 tube ø 12/10mm for PEL gas taps with gasket and screws horizontal		
	<b>Part No.</b>	101241	<b>Ref. No.</b> —
	gas connection thread M20x1.5 tube ø 12/10mm for PEL gas taps vertical		
	<b>Part No.</b>	101248	<b>Ref. No.</b> 07475A
	olive for pipe ø 12mm Qty 1 pcs suitable for PEL		
	<b>Part No.</b>	101249	<b>Ref. No.</b> 01600A
	olive for pipe ø 10mm Qty 1 pcs		
	<b>Part No.</b>	101250	<b>Ref. No.</b> 07463A
	union nut thread M20x1.5 for pipe ø 10mm		
	<b>Part No.</b>	101251	<b>Ref. No.</b> 07462A
	union nut thread M20x1.5 for pipe ø 12mm		
	<b>Part No.</b>	101356	<b>Ref. No.</b> —
	gas tap PEL type 21S gas inlet M16x1.5 (tube ø 10mm) bypass nozzle ø 0.35mm gas outlet M16x1.5 (tube ø 10/8mm) thermocouple connection M10x1 pilot connection M10x1 shaft ø 8x6.5mm shaft L 22/15mm shaft flat lower		
	<b>Part No.</b>	101460	<b>Ref. No.</b> —
	O-ring ø 12.37mm D1 ø 2.62mm suitable for PEL22		
	<b>Part No.</b>	101461	<b>Ref. No.</b> —
	screw kit suitable for PEL22 Qty 4 pcs		
	<b>Part No.</b>	106165	<b>Ref. No.</b> —
	gasket ø 27mm		
	<b>Part No.</b>	110079	<b>Ref. No.</b> —
	knob dial plate gas thermostat 1-8 silver		

<b>accessories for</b>	101159		
	<b>Part No.</b>	110080	<b>Ref. No.</b> —
	knob ø 70mm shaft ø 10x8mm shaft flat universal		

## ROBERTSHAW

			
<b>1</b>			
<b>Part No.</b>	580062	<b>Ref. No.</b>	00295A
<b>description</b>	gas thermostat type BJW 93-287°C 200-550°F gas inlet flange (tube ø 5/16") bypass nozzle ømm gas outlet 3/8" NPT thermocouple connection pilot connection 5/16" UNEF capillary pipe 48" - 1220mm probe ø 3/16" - 4.7mm probe L 11 1/4" - 285mm ROBERTSHAW pipe input ø 7/16" pipe output ø 7/16"		
<b>accessories for</b>	580062		
	<b>Part No.</b>	106659	<b>Ref. No.</b> —
	gas connection suitable for thermostat		
	<b>Part No.</b>	112547	<b>Ref. No.</b> —
	knob gas thermostat t.max. 500°F 200-500°F ø 49mm shaft ømm shaft flat ROBERTSHAW black		

## STN3R

			
<b>1</b>			
<b>Part No.</b>	106207	<b>Ref. No.</b>	00303A 104851
<b>description</b>	gas thermostat t.max. 110°C gas inlet 1/2" gas outlet 1/2" probe ø 6.5mm probe L 200mm capillary pipe 1200mm STN3R		
<b>spare parts for</b>	106207		
	<b>Part No.</b>	106211	<b>Ref. No.</b> —
	knob suitable for STN3R		
	<b>Part No.</b>	106212	<b>Ref. No.</b> —
	knob suitable for STN3R		





1

<b>Part No.</b>	106208	<b>Ref. No.</b>	00300A
<b>description</b>	gas thermostat t.max. 200°C gas inlet 1/2" gas outlet 1/2" probe ø 6mm probe L 120mm capillary pipe 1200mm STN3R		
<b>spare parts for</b>	106208		
	<b>Part No.</b>	106211	<b>Ref. No.</b> —
	knob suitable for STN3R		
	<b>Part No.</b>	106212	<b>Ref. No.</b> —
	knob suitable for STN3R		



1

<b>Part No.</b>	106209	<b>Ref. No.</b>	00304A
<b>description</b>	gas thermostat t.max. 300°C gas inlet 1/2" gas outlet 1/2" probe ø 6.5mm probe L 80mm capillary pipe 1200mm STN3R		
<b>spare parts for</b>	106209		
	<b>Part No.</b>	106211	<b>Ref. No.</b> —
	knob suitable for STN3R		
	<b>Part No.</b>	106212	<b>Ref. No.</b> —
	knob suitable for STN3R		

## ignition parts

### pilot burners







#### SIT

#### 100 series



1

<b>Part No.</b>	106906	<b>Ref. No.</b>	00177A 07550A 7550P
<b>description</b>	pilot burner SIT type 100 series 3 flames nozzle ø 0.2mm gas connection 6mm		
<b>spare parts for</b>	106906		
	<b>Part No.</b>	100245	<b>Ref. No.</b> 01157A 07357A
	pilot burner nozzle LPG code 20 bore ø 0.2mm Qty 1 pcs thread M8x0.75		

<b>spare parts for</b>	106906		
	<b>Part No.</b>	100855	<b>Ref. No.</b> —
	pilot burner bracket triple		
	<b>Part No.</b>	100885	<b>Ref. No.</b> —
	air mixing sleeve for pilot burner Qty 1 pcs		
	<b>Part No.</b>	100916	<b>Ref. No.</b> —
	compression spring for pilot burner Qty 1 pcs		
	<b>Part No.</b>	100917	<b>Ref. No.</b> —
	gasket for pilot burner Qty 1 pcs aluminium		
	<b>Part No.</b>	100918	<b>Ref. No.</b> —
	screw for pilot burner		
	<b>Part No.</b>	107162	<b>Ref. No.</b> —
	pilot burner cap SIT 3 flames Hmm Lmm Qty 1 pcs		
	<b>Part No.</b>	107701	<b>Ref. No.</b> —
	pilot burner bottom part SIT 100 series nozzle ø 0.2mm		
<b>accessories for</b>	106906		
	<b>Part No.</b>	100245	<b>Ref. No.</b> 01157A 07357A
	pilot burner nozzle LPG code 20 bore ø 0.2mm Qty 1 pcs thread M8x0.75		
	<b>Part No.</b>	100246	<b>Ref. No.</b> —
	pilot burner nozzle natural gas bore ø 0.35mm Qty 1 pcs thread M8x0.75		
	<b>Part No.</b>	100904	<b>Ref. No.</b> —
	locking screw M10x1 for pipe ø 4mm Qty 1 pcs		
	<b>Part No.</b>	100905	<b>Ref. No.</b> —
	locking screw M10x1 for pipe ø 6mm Qty 1 pcs		
	<b>Part No.</b>	102110	<b>Ref. No.</b> —
	pilot tube copper pipe ø 4mm thickness 1mm L 3000mm		
	<b>Part No.</b>	102111	<b>Ref. No.</b> —
	pilot tube copper pipe ø 6mm thickness 1mm L 3000mm		
	<b>Part No.</b>	107171	<b>Ref. No.</b> 7357A
	pilot burner nozzle SIT natural/liquid gas bore ø 0.25mm Qty 1 pcs		
	<b>Part No.</b>	107700	<b>Ref. No.</b> —
	pilot burner bottom part SIT 100 series nozzle ø 0.25mm		
	<b>Part No.</b>	107702	<b>Ref. No.</b> —
	pilot burner bottom part SIT 100 series nozzle ø 0.35mm		



			
1			
<b>Part No.</b>	107225	<b>Ref. No.</b>	07551A
<b>description</b>	pilot burner SIT type 100 series 3 flames nozzle $\phi$ 0.4mm gas connection 6mm		

accessories  
pilot burner nozzles

			
1			
<b>Part No.</b>	100245	<b>Ref. No.</b>	01157A 07357A
<b>description</b>	pilot burner nozzle LPG code 20 bore $\phi$ 0.2mm Qty 1 pcs thread M8x0.75		

			
1			
<b>Part No.</b>	102972	<b>Ref. No.</b>	06430A
<b>description</b>	pilot burner nozzle natural gas code 40 bore $\phi$ 0.4mm Qty 1 pcs		

ignition electrodes

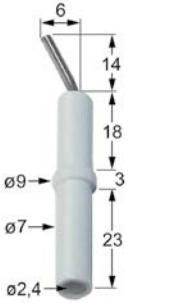
			
1			
<b>Part No.</b>	100707	<b>Ref. No.</b>	05315A
<b>description</b>	ignition electrode D1 $\phi$ 7mm D2 $\phi$ 9mm connection $\phi$ 2.4mm L1 14mm L2 6mm BL1 18mm BL2 3mm BL3 23mm to clip Qty 1 pcs		

electrodes

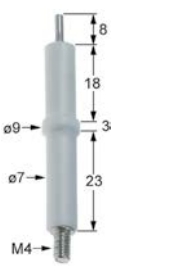
			
1			
<b>Part No.</b>	102871	<b>Ref. No.</b>	07010A
<b>description</b>	ignition electrode D1 $\phi$ 7mm D2 $\phi$ 9mm connection M4 L1 8mm BL1 18mm BL2 3mm BL3 23mm to clip		

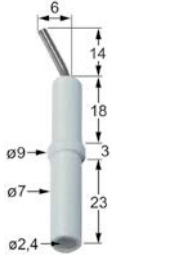
			
1			
<b>Part No.</b>	100707	<b>Ref. No.</b>	05315A
<b>description</b>	ignition electrode D1 $\phi$ 7mm D2 $\phi$ 9mm connection $\phi$ 2.4mm L1 14mm L2 6mm BL1 18mm BL2 3mm BL3 23mm to clip Qty 1 pcs		

ignition cables

			
1			
<b>Part No.</b>	102163	<b>Ref. No.</b>	03013A
<b>description</b>	ignition cable cable length 1500mm connection F2.8mm / $\phi$ 2.4mm		

ignition units

			
1			
<b>Part No.</b>	101012	<b>Ref. No.</b>	02161A
<b>description</b>	ignition unit outputs 2 230VAC dimensions 48x32x32mm mounting distance 56mm inlet F2.8x0.8 outlet F2.8x0.8 type ZIG2 50-60Hz		

			
1			
<b>Part No.</b>	101002	<b>Ref. No.</b>	02161A
<b>description</b>	ignition unit outputs 2 230VAC dimensions 88x23x34mm mounting distance 73mm inlet F6.3x0.8 outlet F2.8x0.8 0.6VA 50/60Hz		

thermocouples

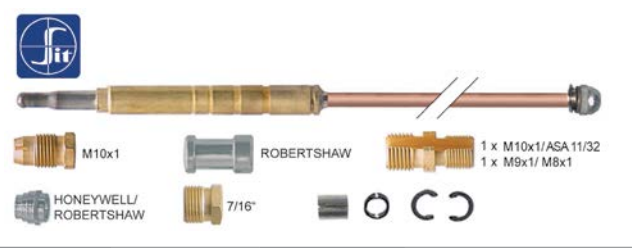
			
1			
<b>Part No.</b>	107647	<b>Ref. No.</b>	00291A
<b>description</b>	thermocouple set SIT 11-piece L 900mm		





1			1 x M8x1 1 x M9x1 1 x M10x1 ASA 11/32
<b>Part No.</b>	102286	<b>Ref. No.</b>	5945A
<b>description</b>	thermocouple set 8-piece L 900mm flexible		

plug-in thermocouples

plug-in thermocouples standard

ROBERTSHAW

1			
<b>Part No.</b>	102277	<b>Ref. No.</b>	286A
<b>description</b>	thermocouple ROBERTSHAW ASA 11/32 L 36" - 915mm 7/16"		

with barrel socket ø6(6.5)mm

thermocouples SIT

1			
<b>Part No.</b>	107614	<b>Ref. No.</b>	00290A 00296A
<b>description</b>	thermocouple SIT M9x1 L 1500mm plug connection ø6.0(6.5)mm		

1			
<b>Part No.</b>	107611	<b>Ref. No.</b>	00291A
<b>description</b>	thermocouple SIT M9x1 L 850mm plug connection ø6.0(6.5)mm		

accessories

interrupters

1			
<b>Part No.</b>	101265	<b>Ref. No.</b>	05690A
<b>description</b>	interrupter thread M9x1		

gas burners

bar burners

bar burners

1			
<b>Part No.</b>	109114	<b>Ref. No.</b>	30400010 505209
<b>description</b>	bar burner 1-row L 550mm Wmm ø 39mm Hmm flange connection tilting bratt pan		

gas nozzles

main nozzles

gas nozzles 3/8"

1			
<b>Part No.</b>	107500	<b>Ref. No.</b>	00191A
<b>description</b>	gas injector thread 3/8" WS 17 bore ø 0.5mm		

1			
<b>Part No.</b>	106526	<b>Ref. No.</b>	00263A
<b>description</b>	gas injector thread 3/8" WS 17 bore ø 0.6mm		

1			
<b>Part No.</b>	106527	<b>Ref. No.</b>	00192A
<b>description</b>	gas injector thread 3/8" WS 17 bore ø 0.7mm		

1			
<b>Part No.</b>	106528	<b>Ref. No.</b>	00264A
<b>description</b>	gas injector thread 3/8" WS 17 bore ø 0.8mm		





1 

<b>Part No.</b>	106532	<b>Ref. No.</b>	00194A
<b>description</b>	gas injector thread 3/8" WS 17 bore ø 1.1mm		

1 

<b>Part No.</b>	106540	<b>Ref. No.</b>	00202A
<b>description</b>	gas injector thread 3/8" WS 17 bore ø 1.8mm		

1 

<b>Part No.</b>	106534	<b>Ref. No.</b>	00195A
<b>description</b>	gas injector thread 3/8" WS 17 bore ø 1.2mm		

1 

<b>Part No.</b>	106541	<b>Ref. No.</b>	00203A
<b>description</b>	gas injector thread 3/8" WS 17 bore ø 1.9mm		

1 

<b>Part No.</b>	106535	<b>Ref. No.</b>	00197A 07280A
<b>description</b>	gas injector thread 3/8" WS 17 bore ø 1.3mm		

1 

<b>Part No.</b>	106531	<b>Ref. No.</b>	00193A
<b>description</b>	gas injector thread 3/8" WS 17 bore ø 1mm		

1 

<b>Part No.</b>	106536	<b>Ref. No.</b>	00198A
<b>description</b>	gas injector thread 3/8" WS 17 bore ø 1.4mm		

1 

<b>Part No.</b>	106543	<b>Ref. No.</b>	00205A G00205A
<b>description</b>	gas injector thread 3/8" WS 17 bore ø 2.1mm		

1 

<b>Part No.</b>	106537	<b>Ref. No.</b>	00199A
<b>description</b>	gas injector thread 3/8" WS 17 bore ø 1.5mm		

1 

<b>Part No.</b>	106544	<b>Ref. No.</b>	00206A
<b>description</b>	gas injector thread 3/8" WS 17 bore ø 2.2mm		

1 

<b>Part No.</b>	106538	<b>Ref. No.</b>	00200A
<b>description</b>	gas injector thread 3/8" WS 17 bore ø 1.6mm		

1 

<b>Part No.</b>	106545	<b>Ref. No.</b>	00207A
<b>description</b>	gas injector thread 3/8" WS 17 bore ø 2.3mm		

1 

<b>Part No.</b>	106539	<b>Ref. No.</b>	00201A
<b>description</b>	gas injector thread 3/8" WS 17 bore ø 1.7mm		

1 

<b>Part No.</b>	106546	<b>Ref. No.</b>	00208A
<b>description</b>	gas injector thread 3/8" WS 17 bore ø 2.4mm		



1 

<b>Part No.</b>	106547	<b>Ref. No.</b>	00209A
<b>description</b>	gas injector thread 3/8" WS 17 bore ø 2.5mm		

1 

<b>Part No.</b>	106555	<b>Ref. No.</b>	00216A
<b>description</b>	gas injector thread 3/8" WS 17 bore ø 3.2mm		

1 

<b>Part No.</b>	106548	<b>Ref. No.</b>	00210A
<b>description</b>	gas injector thread 3/8" WS 17 bore ø 2.6mm		

1 

<b>Part No.</b>	106556	<b>Ref. No.</b>	00217A
<b>description</b>	gas injector thread 3/8" WS 17 bore ø 3.3mm		

1 

<b>Part No.</b>	106549	<b>Ref. No.</b>	00211A
<b>description</b>	gas injector thread 3/8" WS 17 bore ø 2.7mm		

1 

<b>Part No.</b>	106557	<b>Ref. No.</b>	00218A
<b>description</b>	gas injector thread 3/8" WS 17 bore ø 3.5mm		

1 

<b>Part No.</b>	106551	<b>Ref. No.</b>	00212A
<b>description</b>	gas injector thread 3/8" WS 17 bore ø 2.8mm		

1 

<b>Part No.</b>	106558	<b>Ref. No.</b>	00219A 00220A
<b>description</b>	gas injector thread 3/8" WS 17 bore ø 3.6mm		

1 

<b>Part No.</b>	106552	<b>Ref. No.</b>	00213A
<b>description</b>	gas injector thread 3/8" WS 17 bore ø 2.9mm		

1 

<b>Part No.</b>	106559	<b>Ref. No.</b>	00221A
<b>description</b>	gas injector thread 3/8" WS 17 bore ø 3.8mm		

1 

<b>Part No.</b>	106542	<b>Ref. No.</b>	00204A
<b>description</b>	gas injector thread 3/8" WS 17 bore ø 2mm		

1 

<b>Part No.</b>	106553	<b>Ref. No.</b>	00214A
<b>description</b>	gas injector thread 3/8" WS 17 bore ø 3mm		

1 

<b>Part No.</b>	106554	<b>Ref. No.</b>	00215A
<b>description</b>	gas injector thread 3/8" WS 17 bore ø 3.1mm		

1 

<b>Part No.</b>	107208	<b>Ref. No.</b>	00224A
<b>description</b>	gas injector thread 3/8" WS 17 bore ø 4mm		



## pilot burner nozzles

## pilot burner nozzle AB



1

<b>Part No.</b>	102740	<b>Ref. No.</b>	01157A
<b>description</b>	pilot burner nozzle LPG code 20 bore $\varnothing$ 0.2mm Qty 1 pcs		

## pilot burner nozzles AEM



1

<b>Part No.</b>	106429	<b>Ref. No.</b>	08285A
<b>description</b>	pilot burner nozzle natural gas bore $\varnothing$ 0.35mm thread M5x0.75 WS 6		

## pilot burner nozzles SIT

## 100 series



1

<b>Part No.</b>	100245	<b>Ref. No.</b>	01157A 07357A
<b>description</b>	pilot burner nozzle LPG code 20 bore $\varnothing$ 0.2mm Qty 1 pcs thread M8x0.75		



1

<b>Part No.</b>	102972	<b>Ref. No.</b>	06430A
<b>description</b>	pilot burner nozzle natural gas code 40 bore $\varnothing$ 0.4mm Qty 1 pcs		



1

<b>Part No.</b>	107171	<b>Ref. No.</b>	7357A
<b>description</b>	pilot burner nozzle SIT natural/liquid gas bore $\varnothing$ 0.25mm Qty 1 pcs		

## pilot burner nozzles (other)

## SOLYMAC/CAPIC



1

<b>Part No.</b>	106429	<b>Ref. No.</b>	08285A
<b>description</b>	pilot burner nozzle natural gas bore $\varnothing$ 0.35mm thread M5x0.75 WS 6		

## auxiliary gas parts

## screw connections

## olives



1

<b>Part No.</b>	101249	<b>Ref. No.</b>	01600A
<b>description</b>	olive for pipe $\varnothing$ 10mm Qty 1 pcs		

accessories for 101249



<b>Part No.</b>	101250	<b>Ref. No.</b>	07463A
-----------------	--------	-----------------	--------

union nut thread M20x1.5 for pipe  $\varnothing$  10mm

1

<b>Part No.</b>	101248	<b>Ref. No.</b>	07475A
<b>description</b>	olive for pipe $\varnothing$ 12mm Qty 1 pcs suitable for PEL		

accessories for 101248



<b>Part No.</b>	101251	<b>Ref. No.</b>	07462A
-----------------	--------	-----------------	--------

union nut thread M20x1.5 for pipe  $\varnothing$  12mm

1

<b>Part No.</b>	101286	<b>Ref. No.</b>	05377A
<b>description</b>	olive ID $\varnothing$ 6mm Qty 1 pcs		

accessories for 101286



<b>Part No.</b>	100909	<b>Ref. No.</b>	07011A
-----------------	--------	-----------------	--------

union screw thread M10x1 for pipe  $\varnothing$  6mm Qty 1 pcs

<b>Part No.</b>	101464	<b>Ref. No.</b>	—
-----------------	--------	-----------------	---

union nut thread M12x1 for pipe  $\varnothing$  6mm

## union nuts

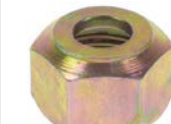

1

<b>Part No.</b>	101250	<b>Ref. No.</b>	07463A
<b>description</b>	union nut thread M20x1.5 for pipe $\varnothing$ 10mm		



accessories for 101250



<b>Part No.</b>	101249	<b>Ref. No.</b>	01600A
-----------------	--------	-----------------	--------

olive for pipe  $\varnothing$  10mm Qty 1 pcs



			
1			
<b>Part No.</b>	101251	<b>Ref. No.</b>	07462A
<b>description</b>	union nut thread M20x1.5 for pipe ø 12mm		
<b>accessories for</b>	101251		
	<b>Part No.</b>	101248	<b>Ref. No.</b> 07475A
	olive for pipe ø 12mm Qty 1 pcs suitable for PEL		

union screws			
			
1			
<b>Part No.</b>	100909	<b>Ref. No.</b>	07011A
<b>description</b>	union screw thread M10x1 for pipe ø 6mm Qty 1 pcs		
<b>accessories for</b>	100909		
	<b>Part No.</b>	100898	<b>Ref. No.</b> —
	olive for pipe ø 6mm Qty 1 pcs for pilot burner		
	<b>Part No.</b>	101286	<b>Ref. No.</b> 05377A
	olive ID ø 6mm Qty 1 pcs		
	<b>Part No.</b>	101287	<b>Ref. No.</b> —
	olive for pipe ø 6mm Qty 1 pcs		
	<b>Part No.</b>	101288	<b>Ref. No.</b> —
	olive for pipe ø 6mm L 6mm aluminium Qty 1 pcs ED ø 8.5mm		

pressure switches			
			
1			
<b>Part No.</b>	541051	<b>Ref. No.</b>	07835A
<b>description</b>	pressure control ø 45mm pressure range adjustable 10-50mbar pressure connection vertical gas technology connection 1/4" pressure connection ø 1/4"mm		

## equipment-specific units

### for coffee grinders

			
1			
<b>Part No.</b>	345742	<b>Ref. No.</b>	07676A
<b>description</b>	microswitch with lever 250V 16A 1CO connection male faston 6.3mm L 55mm ambient temperature max. 120°C mounting distance 22mm actuating force: 75g lever length 46mm		

### for tilting bratt pans

#### spare parts and accessories

			
1			
<b>Part No.</b>	692703	<b>Ref. No.</b>	04256A
<b>description</b>	bush thickness 5mm ID ø 20mm H 20mm ext. ø 30 Qty 1 pcs		

### for boiling pans

#### level glasses

#### accessories

			
1			
<b>Part No.</b>	541856	<b>Ref. No.</b>	03001A
<b>description</b>	water level tube ø 15mm L 160mm thickness 2.5mm glas		



knobs

universal knobs



1

<b>Part No.</b>	110232	<b>Ref. No.</b>	08561A
<b>description</b>	knob switch 4-position t.max.°C°C ø 50mm shaft ø 6x4.6mm shaft flat upper black		

producer-specific knobs

CHARVET



1

<b>Part No.</b>	111477	<b>Ref. No.</b>	02021A
<b>description</b>	bezel energy regulator 0-100 t.max.°C°C ø 88mm shaft ømm shaft flat		



1

<b>Part No.</b>	111476	<b>Ref. No.</b>	02016A
<b>description</b>	knob zero mark t.max.°C°C ø 46mm shaft ø 6x4.6mm shaft flat upper black		

accessories

fascias



1

<b>Part No.</b>	111477	<b>Ref. No.</b>	02021A
<b>description</b>	bezel energy regulator 0-100 t.max.°C°C ø 88mm shaft ømm shaft flat		

locks



edgemount latches

handle latches

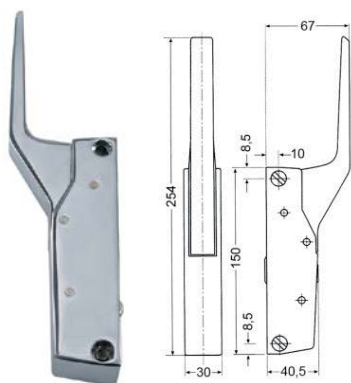
CAFF/FERMOD



1

<b>Part No.</b>	700060	<b>Ref. No.</b>	04205A	
<b>description</b>	handle latch L 150mm mounting distance 133mm non lockable heated units G 791			
<b>accessories for</b>	700060			
	<b>Part No.</b>	700061	<b>Ref. No.</b>	—
	door catch L 58mm W 20mm H 35mm mounting distance 42mm chrome-plated brass for headed units			
	<b>Part No.</b>	700062	<b>Ref. No.</b>	—
	handle protection heated units			

miscellaneous



1

<b>Part No.</b>	511612	<b>Ref. No.</b>	FERM001
<b>description</b>	closing plate Qty 2 pcs		

fittings for catering equipment



drain taps

brass

drain taps



1

<b>Part No.</b>	548001	<b>Ref. No.</b>	03917A
<b>description</b>	drain tap 1 1/2" IT O-ring seal kettle connection with union nut A 80mm B1 68mm B2 132mm		
<b>spare parts for</b>	548001		
	<b>Part No.</b>	505092	<b>Ref. No.</b> —
	O-ring EPDM thickness 5.34mm ID $\phi$ 43.82mm Qty 1 pcs		
	<b>Part No.</b>	540213	<b>Ref. No.</b> —
	handle ID $\phi$ 5mm L 117mm		



1

<b>Part No.</b>	541673	<b>Ref. No.</b>	3917A
<b>description</b>	drain tap 1 1/2" IT with union nut conical seal		
<b>spare parts for</b>	541673		
	<b>Part No.</b>	540213	<b>Ref. No.</b> —
	handle ID $\phi$ 5mm L 117mm		
	<b>Part No.</b>	540956	<b>Ref. No.</b> —
	gasket for drain tap hose ext. $\phi$ 46mm ID $\phi$ 38mm H 2mm		
<b>accessories for</b>	541673		
	<b>Part No.</b>	510404	<b>Ref. No.</b> —
	flat gasket fibre ED $\phi$ 44mm ID $\phi$ 34mm thickness 2mm Qty 1 pcs		
	<b>Part No.</b>	890116	<b>Ref. No.</b> —
	fitting grease FERMIT GLISSA tube 60g -20 up to +140°C approval complies with KTW recommendation		
	<b>Part No.</b>	890118	<b>Ref. No.</b> —
	fitting grease FERMIT GLISSA can 1000g -20 up to +140°C approval complies with KTW recommendation		
	<b>Part No.</b>	890119	<b>Ref. No.</b> —
	fitting grease FERMIT GLISSA tube 30g -20 up to +140°C approval complies with KTW recommendation		



1

<b>Part No.</b>	541872	<b>Ref. No.</b>	07358A
<b>description</b>	drain tap ball valve A 68mm B1 33mm B2 85mm thread 1" IT		

gaskets

gaskets for heated units

window seals

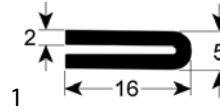

<b>Part No.</b>	901567	<b>Ref. No.</b>	02286A
<b>description</b>	window gasket profile 1879 L 2350mm suitable for CHARVET Qty 1		

door seals

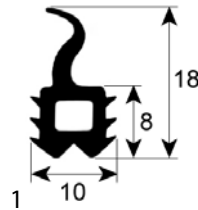

<b>Part No.</b>	901424	<b>Ref. No.</b>	Join021
<b>description</b>	door seal profile 2711 L 2600mm Qty 1		

O-rings

EPDM

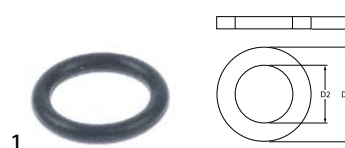

<b>Part No.</b>	501413	<b>Ref. No.</b>	04087A
<b>description</b>	O-ring EPDM thickness 3mm ID $\phi$ 14mm Qty 1 pcs		





## silicone

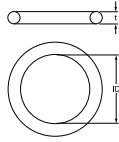

1

<b>Part No.</b>	532519	<b>Ref. No.</b>	504952
<b>description</b>	O-ring silicone thickness 5.34mm ID ø 53.34mm Qty 1 pcs		

## manometers



1

<b>Part No.</b>	541579	<b>Ref. No.</b>	0798A
<b>description</b>	manometer ø 52mm pressure range 0 up to 1bar connection marking 0.5 thread 1/4"		



1

<b>Part No.</b>	541062	<b>Ref. No.</b>	07986A
<b>description</b>	manometer ø 63mm pressure range 0 up to 1bar connection marking adjustable kettle thread 1/4"		
<b>spare parts for</b>	541062		
	<b>Part No.</b>	541130	<b>Ref. No.</b> —
	glass panel ø 58mm thickness 2mm		

## dosing pumps

## membrane dosing pumps

## self-priming

## LANG

## accessories



1

<b>Part No.</b>	101286	<b>Ref. No.</b>	05377A
<b>description</b>	olive ID ø 6mm Qty 1 pcs		

## accessories for 101286



<b>Part No.</b>	100909	<b>Ref. No.</b>	07011A
<b>description</b>	union screw thread M10x1 for pipe ø 6mm Qty 1 pcs		



<b>Part No.</b>	101464	<b>Ref. No.</b>	—
<b>description</b>	union nut thread M12x1 for pipe ø 6mm		

## fastening material

## nuts

## hexagonal nuts

## hexagonal nuts with PG thread



1

<b>Part No.</b>	550577	<b>Ref. No.</b>	02407A
<b>description</b>	nut thread PG16 H 3mm WS 26 nickel-plated brass Qty 1 pcs mounting ømm cable ømm		

**GASTRO**PARTS.COM

