



**GASTROPARTS**

# CF-Cenedese

- [EN]** Equipment
- [DE]** Geräte
- [ES]** Aparatos
- [FR]** Équipement
- [IT]** Attrezzature
- [PL]** Urządzenia
- [RU]** Оборудование

✉ [gastroparts@gastroparts.com](mailto:gastroparts@gastroparts.com)

☎ tel. +48 56 657 00 66

📘 [fb.com/gastroparts.global](https://fb.com/gastroparts.global)

**GASTROPARTS.COM**









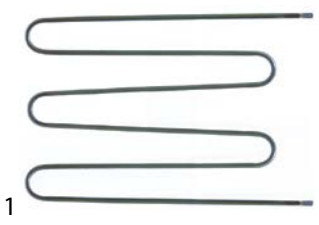

## heating elements

### heating elements for bain maries

			
<b>Part No.</b>	416194	<b>Ref. No.</b>	63.7.1052
<b>description</b>	heating element 1189W 230V heating circuits 1 L 278mm W 150mm connection male faston 6.3mm tube ø 6.3mm 2 hole fixing thread 1/8" immersion heater/dry heating element L1 135mm L2 143mm H 22mm mounting distance 144mm		
<b>For models:</b>	BM23		





			
<b>Part No.</b>	416195	<b>Ref. No.</b>	63.7.1023
<b>description</b>	heating element 1500W 230V heating circuits 1 L 368mm L1 23mm W 268mm connection male faston 6.3mm connection distance 263mm tube ø 6.3mm dry heating element bain marie L2 345mm H 19mm		

			
<b>Part No.</b>	416193	<b>Ref. No.</b>	63.7.1051
<b>description</b>	heating element 823W 230V heating circuits 1 L 280mm W 106mm connection male faston 6.3mm tube ø 6.3mm 2 hole fixing thread M10x1 dry heating element bain marie L1 135mm L2 145mm W1 27mm W2 105mm H 18mm mounting distance 100mm		
<b>For models:</b>	BM11, BM12, BM13		
<b>accessories for</b>	416193		
	<b>Part No.</b>	510416	<b>Ref. No.</b> —
	flat gasket fibre ED ø 19mm ID ø 10.5mm thickness 1.5mm for thread M10 Qty 1 pcs		
	<b>Part No.</b>	510893	<b>Ref. No.</b> —
	O-ring EPDM thickness 2.62mm ID ø 9.92mm Qty 1 pcs		
	<b>Part No.</b>	520231	<b>Ref. No.</b> —
	nut thread M10x1 H 6mm WS 14 zinc-coated steel Qty 1 pcs		
	<b>Part No.</b>	521129	<b>Ref. No.</b> —
	nut thread M10 H 6mm SS WS 17 Qty 1 pcs DIN/ISO DIN 439		

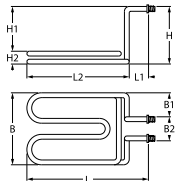
### heating elements for fryers

#### 2 hole fixing

 			
<b>Part No.</b>	415721	<b>Ref. No.</b>	63.7.1064
<b>description</b>	heating element 2100W 230V heating circuits 1 L 292mm W 107mm H 200mm 2 hole fixing connection M4 fryer heaters L1 25mm L2 267mm W1 21mm W2 65mm H1 162mm H2 38mm tube ø 8.5mm thread 1/4" mounting distance 99mm connection length 23mm		
<b>For models:</b>	FE04, FE44		

<b>Part No.</b>	415721	<b>Ref. No.</b>	63.7.1064
<b>description</b>	heating element 2100W 230V heating circuits 1 L 292mm W 107mm H 200mm 2 hole fixing connection M4 fryer heaters L1 25mm L2 267mm W1 21mm W2 65mm H1 162mm H2 38mm tube ø 8.5mm thread 1/4" mounting distance 99mm connection length 23mm		
<b>For models:</b>	FE04, FE44		
<b>accessories for</b>	415721		
	<b>Part No.</b>	361182	<b>Ref. No.</b> —
	nut thread 1/4" H 5mm nickel-plated brass WS 17 Qty 1 pcs		
	<b>Part No.</b>	510417	<b>Ref. No.</b> —
	flat gasket fibre ED ø 20mm ID ø 14mm thickness 2mm Qty 1 pcs		
	<b>Part No.</b>	520228	<b>Ref. No.</b> —
	tooth lock washer ID ø 15.3mm ED ø 24mm steel Qty 1 pcs for thread M14		
	<b>Part No.</b>	521103	<b>Ref. No.</b> —
	nut thread M4 H 3mm WS 7 brass Qty 20 pcs		
	<b>Part No.</b>	521104	<b>Ref. No.</b> —
	washer ID ø 4.3mm ED ø 8mm thickness 0.5mm brass Qty 20 pcs for thread M4		
	<b>Part No.</b>	550262	<b>Ref. No.</b> —
	flat gasket copper ED ø 20mm ID ø 14mm thickness 2mm		
	<b>Part No.</b>	560111	<b>Ref. No.</b> —
	plain washer ID ø 4.3mm ED ø 9mm thickness 0.8mm SS Qty 20 pcs DIN 125A for thread M4		
	<b>Part No.</b>	560131	<b>Ref. No.</b> —
	hexagonal nut thread M4 H 3.2mm WS 7 SS DIN/ISO DIN 934 / ISO 4032/8673 Qty 20 pcs		

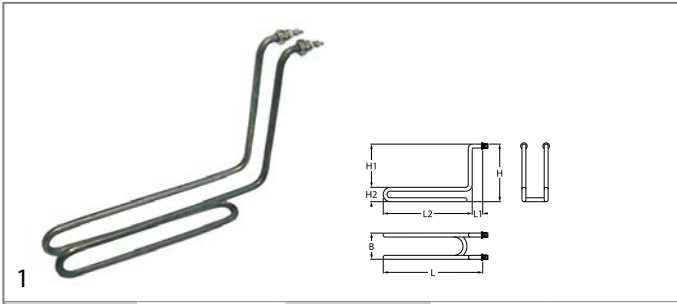

<b>Part No.</b>	415720	<b>Ref. No.</b>	63.7.1068
<b>description</b>	heating element 1400W 230V heating circuits 1 L 275mm W 40mm H 210mm L1 15mm L2 260mm H1 165mm H2 45mm thread 1/4" mounting distance 32mm tube ø 8.5mm 2 hole fixing connection M4 fryer heaters windings 2		
<b>For models:</b>	FE07T, FE77T		
<b>accessories for</b>	415720		
	<b>Part No.</b>	361182	<b>Ref. No.</b> —
	nut thread 1/4" H 5mm nickel-plated brass WS 17 Qty 1 pcs		
	<b>Part No.</b>	510417	<b>Ref. No.</b> —
	flat gasket fibre ED ø 20mm ID ø 14mm thickness 2mm Qty 1 pcs		
	<b>Part No.</b>	520228	<b>Ref. No.</b> —
	tooth lock washer ID ø 15.3mm ED ø 24mm steel Qty 1 pcs for thread M14		
	<b>Part No.</b>	521103	<b>Ref. No.</b> —
	nut thread M4 H 3mm WS 7 brass Qty 20 pcs		
	<b>Part No.</b>	521104	<b>Ref. No.</b> —
	washer ID ø 4.3mm ED ø 8mm thickness 0.5mm brass Qty 20 pcs for thread M4		
	<b>Part No.</b>	550262	<b>Ref. No.</b> —
	flat gasket copper ED ø 20mm ID ø 14mm thickness 2mm		
	<b>Part No.</b>	560111	<b>Ref. No.</b> —
	plain washer ID ø 4.3mm ED ø 9mm thickness 0.8mm SS Qty 20 pcs DIN 125A for thread M4		
	<b>Part No.</b>	560131	<b>Ref. No.</b> —
	hexagonal nut thread M4 H 3.2mm WS 7 SS DIN/ISO DIN 934 / ISO 4032/8673 Qty 20 pcs		

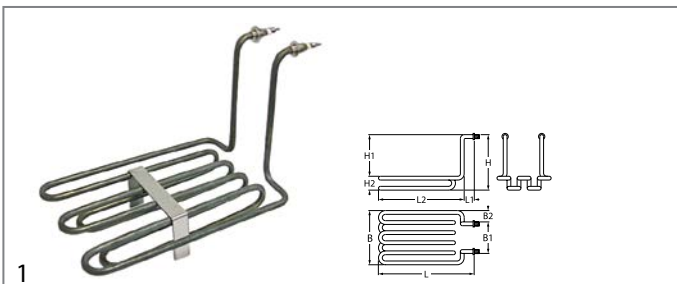

<b>Part No.</b>	415722	<b>Ref. No.</b>	63.7.1067
<b>description</b>	heating element 3000W 230V heating circuits 1 L 280mm W 180mm H 200mm L1 25mm L2 255mm H1 160mm H2 40mm thread 1/4" mounting distance 76mm tube ø 8.5mm 2 hole fixing connection M4 connection length 28mm fryer heaters windings 6 W1 45mm W2 85mm		
<b>For models:</b>	FE07, FE77		
<b>spare parts for</b>	415722		
	<b>Part No.</b>	510417	<b>Ref. No.</b> —
	flat gasket fibre ED ø 20mm ID ø 14mm thickness 2mm Qty 1 pcs		

<b>accessories for</b>	415722		
	<b>Part No.</b>	521103	<b>Ref. No.</b> —
	nut thread M4 H 3mm WS 7 brass Qty 20 pcs		
	<b>Part No.</b>	521104	<b>Ref. No.</b> —
	washer ID ø 4.3mm ED ø 8mm thickness 0.5mm brass Qty 20 pcs for thread M4		
	<b>Part No.</b>	560111	<b>Ref. No.</b> —
	plain washer ID ø 4.3mm ED ø 9mm thickness 0.8mm SS Qty 20 pcs DIN 125A for thread M4		
	<b>Part No.</b>	560131	<b>Ref. No.</b> —
	hexagonal nut thread M4 H 3.2mm WS 7 SS DIN/ISO DIN 934 / ISO 4032/8673 Qty 20 pcs		

## heating elements for hot counters

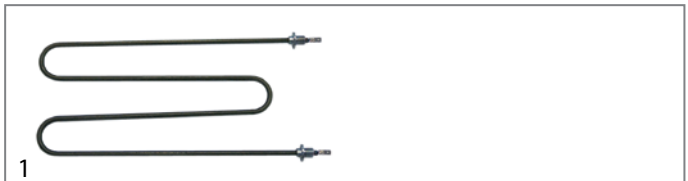

<b>Part No.</b>	415699	<b>Ref. No.</b>	63.7.1090
<b>description</b>	heating element 400W 230V heating circuits 1 L 298mm W 138mm tube ø 6.3mm connection male faston 6.3mm dry heating element for vitrine 2 hole fixing thread M12x1.25 mounting distance 132mm		
<b>For models:</b>	VEC 10, VEC 20, VEC 510, VEC 520		

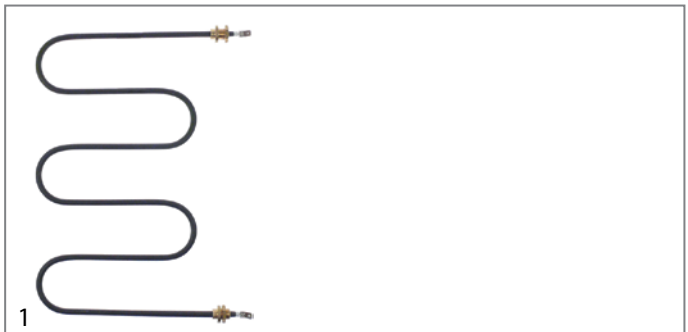

<b>Part No.</b>	417667	<b>Ref. No.</b>	63.7.1026
<b>description</b>	heating element 450W 230V heating circuits 1 L 188mm W 280mm tube ø 6.5mm		

## heating elements for refrigeration



### condensing trays heated





<b>Part No.</b>	750003	<b>Ref. No.</b>	750003
<b>description</b>	condensing tray heated L 240mm W 240mm H 75mm 230V 650W connect with power contactor		
<b>spare parts for</b>	750003		
	<b>Part No.</b>	348139	<b>Ref. No.</b> —
	float switch 250V 1A 1NO or 1NC thread M16x1.5 ø 17.4mm L 100.5mm mounting ø 28mm cable length 1500mm temp.-resist. -20 up to +90°C		

Table continues overleaf



spare parts for		750003	
	Part No.	418732	Ref. No.
	heating element 650W 230V L 280mm W 95mm H 87mm L1 65mm L2 215mm cable length 1500mm connection distance 86mm tube ø 8.5mm heating circuits 1 immersion heater		
accessories for		750003	
	Part No.	380185	Ref. No.
	power relays Italiana Relè 230VAC 30A 1NO connection F6.3 bracket mounting dimensions 36.5x32.2x51.8mm manuf. no. A10-230AC-FA		



Part No.	750004	Ref. No.	750004
description	condensing tray heated L 380mm W 240mm H 75mm 230V 750W with float switch		
spare parts for		750004	
	Part No.	348139	Ref. No.
	float switch 250V 1A 1NO or 1NC thread M16x1.5 ø 17.4mm L 100.5mm mounting ø 28mm cable cable length 1500mm temp.-resist. -20 up to +90°C		
	Part No.	418733	Ref. No.
	heating element 750W 230V L 430mm W 95mm H 98mm L1 85mm L2 345mm cable length 1500mm connection cable connection distance 86mm tube ø 8.5mm heating circuits 1 immersion heater		
accessories for		750004	
	Part No.	380185	Ref. No.
	power relays Italiana Relè 230VAC 30A 1NO connection F6.3 bracket mounting dimensions 36.5x32.2x51.8mm manuf. no. A10-230AC-FA		



Part No.	415726	Ref. No.	63.7.1012
description	heating element 750W 230V L 180mm W 170mm H 18mm W1 45mm W2 80mm connection length 26mm tube ø 6.3mm windings 3 connection M4 dry heating element		
For models:	PD 1020 L, PD 1020 M, PD 1020 R, PD 2020 L, PD 2020 M, PD 2020 R, PS 1010 L, PS 1010 R, PS 2010 L, PS 2010 LB, PS 2010 R, PS 2010 RB		



Part No.	415727	Ref. No.	63.7.1011
description	heating element 900W 230V L 180mm W 175mm H 15mm W1 42mm W2 91mm connection length 24mm tube ø 6.3mm windings 3 connection M4 dry heating element		
For models:	PD 1020 L, PD 1020 LB, PD 1020 M, PD 1020 MB, PD 1020 R, PD 1020 RB, PD 2020 L, PD 2020 LB, PD 2020 M, PD 2020 MB, PD 2020 R, PD 2020 RB, PS 1010 L, PS 1010 LB, PS 1010 R, PS 1010 RB, PS 2010 L, PS 2010 LB, PS 2010 R, PS 2010 RB		

heating elements for contact grills

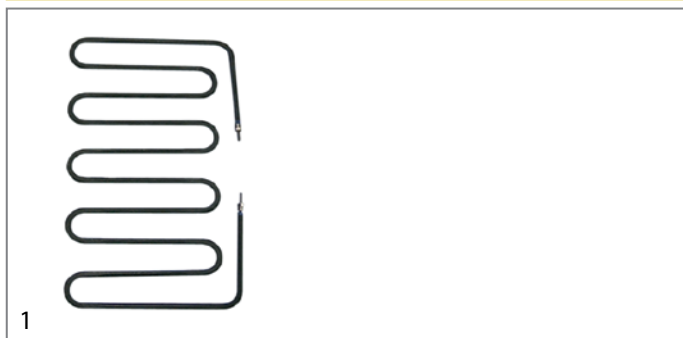

Part No.	415724	Ref. No.	63.7.1015
description	heating element 1200W 230V L 192mm W 305mm H 10mm W1 102mm W2 100mm tube ø 6mm windings 5 connection M4 dry heating element		
For models:	B800E, PM 1015 L, PM 1015 LB, PM 1015 R, PM 1015 RB, PM 2015 L, PM 2015 LB, PM 2015 R, PM 2015 RB		

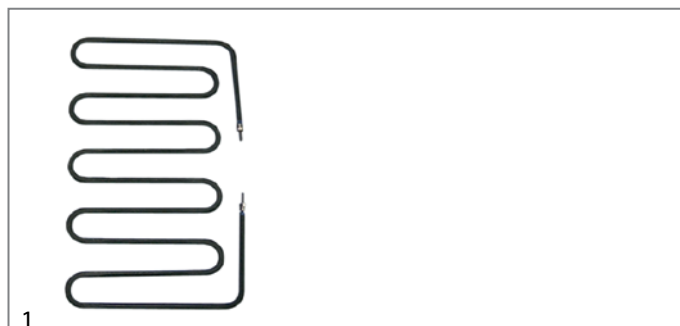

Part No.	415725	Ref. No.	63.7.1016
description	heating element 900W 230V L 194mm W 300mm H 17mm W1 100mm W2 100mm connection length 25mm tube ø 6.3mm windings 5 connection M4 dry heating element		
For models:	PM 1015 L, PM 1015 R, PM 2015 L, PM 2015 R		



## heating elements for pizza ovens

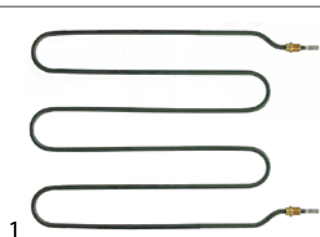

<b>Part No.</b>	416188	<b>Ref. No.</b>	63.7.1088
<b>description</b>	heating element 800W 230V L 365mm W 290mm L1 30mm L2 40mm L3 295mm W1 18mm W2 254mm thread 1/4" mounting distance 246mm connection length 33mm connection male faston 6.3mm windings 3 tube ø 6.3mm heating circuits 1 dry heating element 2 hole fixing		
<b>For models:</b>	FP36, FP36R, FP66R		
<b>spare parts for</b>	416188		
	<b>Part No.</b>	361182	<b>Ref. No.</b> —
	nut thread 1/4" H 5mm nickel-plated brass WS 17 Qty 1 pcs		

## heating elements for rolling grills



<b>Part No.</b>	416189	<b>Ref. No.</b>	63.7.1081 63.7.1098
<b>description</b>	heating element 220W 240V heating circuits 1 L 359mm connection distance 359mm tube ø 8.5mm dry heating element roller grill		
<b>For models:</b>	CW6, CW8		

## heating elements for salamanders/toast-

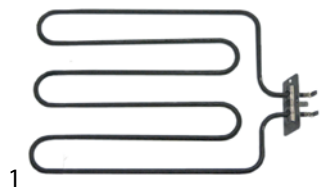

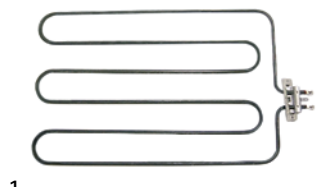

<b>Part No.</b>	415723	<b>Ref. No.</b>	63.7.1022
<b>description</b>	heating element 1900W 230V L 305mm W 260mm L1 25mm L2 280mm W1 90mm W2 30mm hole distance 60mm connection male faston 6.3mm tube ø 6.3mm flange length 70mm flange width 36mm heating circuits 1 hole ø 4.9mm tilt flange dry heating element H 6.3mm		
<b>For models:</b>	SE2, SE2M		



<b>Part No.</b>	415757	<b>Ref. No.</b>	63.7.1021
<b>description</b>	heating element 2400W 230V L 425mm W 260mm L1 25mm L2 400mm W1 90mm W2 30mm hole distance 60mm connection male faston 6.3mm tube ø 6.3mm flange length 70mm flange width 36mm heating circuits 1 hole ø 5mm tilt flange dry heating element		
<b>For models:</b>	SE1, SE1M		



<b>Part No.</b>	415698	<b>Ref. No.</b>	63.7.1093
<b>description</b>	heating element 1000W 230V L 330mm W 140mm 2 hole fixing thread M12x1.25 mounting distance 133mm connection male faston 6.3mm dry heating element tube ø 6.3mm heating circuits 1 connection length 33mm H 6.3mm		
<b>For models:</b>	SEPC, T930, T960		
<b>spare parts for</b>	415698		
	<b>Part No.</b>	521110	<b>Ref. No.</b> —
	flat gasket fibre ED ø 20mm ID ø 13mm thickness 2mm Qty 1 pcs		
<b>accessories for</b>	415698		
	<b>Part No.</b>	550681	<b>Ref. No.</b> —
	nut thread M12x1.25 H 5mm WS 17 brass Qty 1 pcs		

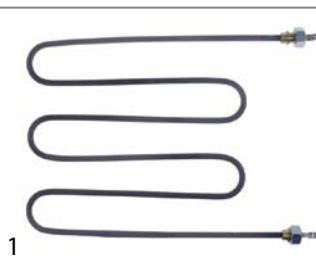

<b>Part No.</b>	416199	<b>Ref. No.</b>	63.7.1083
<b>description</b>	heating element 1600W 230V L 270mm W 210mm 2 hole fixing thread M12x1.5 mounting distance 204mm connection male faston 6.3mm dry heating element tube ø 6.3mm heating circuits 1		
<b>For models:</b>	B830, B840, B860, B870		

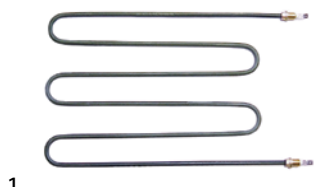

<b>Part No.</b>	415694	<b>Ref. No.</b>	63.7.1084
<b>description</b>	heating element 2000W 230V L 350mm W 205mm 2 hole fixing thread M12x1.25 mounting distance 198mm connection male faston dry heating element tube ø 6.3mm heating circuits 1 connection length 33mm H 6.3mm		
<b>For models:</b>	B800E, B840, SEP, SEPC		

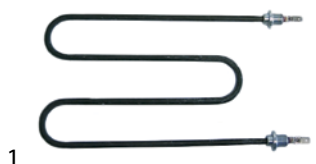

<b>Part No.</b>	415697	<b>Ref. No.</b>	63.7.1092
<b>description</b>	heating element 800W 230V L 225mm W 135mm 2 hole fixing thread M12x1 mounting distance 128mm connection male faston 6.3mm dry heating element tube ø 6.3mm heating circuits 1 H 6.3mm		
<b>For models:</b>	T920, T940		





heating cartridges

1			
<b>Part No.</b>	416190	<b>Ref. No.</b>	63.7.1040
<b>description</b>	heating cartridge 80W 230V ø 24mm L 102mm cable length 345mm dry heating element		
<b>For models:</b>	HD20, HD40, PT40, PT60		

quartz heating elements

1			
<b>Part No.</b>	693058	<b>Ref. No.</b>	63.7.0002
<b>description</b>	insulator female L 7mm hole ø 5.5mm ø 13mm		

1			
<b>Part No.</b>	419205	<b>Ref. No.</b>	63.7.1097
<b>description</b>	quartz heating element 300W 115V L 360mm ø 11.5mm connection male faston 6.3mm		

1			
<b>Part No.</b>	416187	<b>Ref. No.</b>	63.7.1094
<b>description</b>	quartz heating element 400W 115V L 260mm ø 12mm connection male faston 6.3mm mounting distance 24.8mm		
<b>For models:</b>	SEPC, T920, T940		

1			
<b>Part No.</b>	419204	<b>Ref. No.</b>	63.7.1095
<b>description</b>	quartz heating element 500W 115V L 360mm ø 11.5mm connection male faston 6.3mm		
<b>For models:</b>	T930, T960		

1			
<b>Part No.</b>	415312	<b>Ref. No.</b>	63.7.1094 old version
<b>description</b>	quartz heating element L 285mm ø 11.5mm 800W 230V W 130mm connection eye double		

radiation heaters

square

1			
<b>Part No.</b>	416192	<b>Ref. No.</b>	63.7.1100
<b>description</b>	radiation heater L 225mm W 225mm 750W 230V heating circuits 1 connections 2 square		
<b>For models:</b>	PDV 3020 L, PDV 3020 R, PDV-3020-McDonalds, PSV 3010 L, PSV 3010 R		

accessories

1			
<b>Part No.</b>	693058	<b>Ref. No.</b>	63.7.0002
<b>description</b>	insulator female L 7mm hole ø 5.5mm ø 13mm		

1			
<b>Part No.</b>	693057	<b>Ref. No.</b>	63.7.0001
<b>description</b>	insulator male L 10mm hole ø 8.4mm ø 13mm		

hot plates

round

with radiused edge

for domestic and commercial kitchens

1			
<b>Part No.</b>	416191	<b>Ref. No.</b>	63.7.1030
<b>description</b>	hot plate ø 90mm 450W 230V connection 3 screw clamps with 8mm spill ring		
<b>For models:</b>	HD20, HD40		



## energy regulators

## EGO

## 1-circuit



<b>Part No.</b>	380015	<b>Ref. No.</b>	63.7.0601
<b>description</b>	energy regulator 230V 13A single-circuit turn direction right shaft ø 6x4.6mm shaft L 23mm mounting thread M4 power release 6-100% no. 50.57021.010		
<b>For models:</b>	CW6, CW8, HD20, HD40, SE1, SE1M, SEP, SEPC, TN30 PLUS		

## accessories

## knobs



<b>Part No.</b>	110075	<b>Ref. No.</b>	63.7.0280
<b>description</b>	knob energy regulator 1-3 t.max.°C ø 50mm shaft ø 6x4.6mm shaft flat upper black		
<b>For models:</b>	SE1, SE1M		
<b>accessories for</b>	110075		



<b>Part No.</b>	110135	<b>Ref. No.</b>	—
<b>description</b>	rosette knob up to ø 52mm		

## thermostats

## bi-metal thermostats

## safety bi-metal thermostats



<b>Part No.</b>	390026	<b>Ref. No.</b>	63.7.0670
<b>description</b>	bi-metal safety thermostat hole distancemm switch-off temp. 70°C 1NC 1-pole 16A connection F6.3 M4		

## bi-metal thermostats



<b>Part No.</b>	390850	<b>Ref. No.</b>	63.7.0680
<b>description</b>	bi-metal thermostat hole distancemm switch-off temp. 250°C 1NC 1-pole 10A 250V connection F6.3 1 hole fixing for contact grill		
<b>For models:</b>	PDV-3020-McDonalds		

## control and safety thermostats

## EGO

## control thermostats

## 55.10/19\_ series



<b>Part No.</b>	375232	<b>Ref. No.</b>	63.7.0635
<b>description</b>	thermostat t.max. 320°C temperature range 55-320°C 1-pole capillary pipe isolatedmm gland nut		
<b>For models:</b>	FP36, FP36R, FP66R		

## safety thermostats

## 56.\_ series





<b>Part No.</b>	390610	<b>Ref. No.</b>	63.7.0632
<b>description</b>	safety thermostat switch-off temp. 235°C 1-pole 16A probe ø 3mm probe L 190mm capillary pipe 1000mm capillary pipe isolated 640mm gland nut probe SS		
<b>For models:</b>	FE04, FE07, FE07T, FE77, FE77T		



IMIT / TEMPOMATIC / ARATHERMO

control thermostats



<b>Part No.</b>	390006	<b>Ref. No.</b>	63.7.0658
<b>description</b>	thermostat t.max. 86°C temperature range 0-86°C 1-pole 1CO 16A probe ø 6.5mm probe L 95mm capillary pipe 1500mm capillary pipe isolatedmm gland nut shaft ø 6x4.6mm shaft L 19mm rotation 270°		
<b>For models:</b>	VEC 510, VEC 520		
<b>accessories for</b>	390006		
	<b>Part No.</b>	110100	<b>Ref. No.</b> —
	knob thermostat t.max. 90°C 0-90°C ø 42mm shaft ø 6x4.6mm shaft flat -135° black		
	<b>Part No.</b>	110105	<b>Ref. No.</b> —
	rosette knob ø 42mm ø 56mm zero mark		

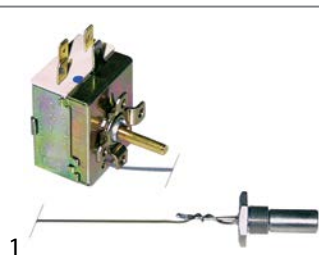

<b>Part No.</b>	375318	<b>Ref. No.</b>	63.7.0655
<b>description</b>	thermostat t.max. 90°C temperature range 0-90°C 1-pole 1CO 15A probe ø 11mm probe L 36mm capillary pipe 600mm capillary pipe isolated 550mm gland nut shaft ø 6x4.6mm shaft L 19mm shaft position upper rotation 270° screw-in probe probe thread M14x1		
<b>For models:</b>	B830, B850, BM11, BM12, BM13, BM23, VEC 10, VEC 20		

TECASA

control thermostats



<b>Part No.</b>	390027	<b>Ref. No.</b>	63.7.0640
<b>description</b>	thermostat t.max. 190°C temperature range 50-190°C 1-pole 1NO 16A probe ø 3mm probe L 145mm capillary pipe 880mm capillary pipe isolated 680mm gland nut shaft ø 6x4.6mm rotation 270° probe material SS		
<b>For models:</b>	F620, F640, FE04, FE07, FE07T, FE44, FE77, FE77T		

safety thermostats



<b>Part No.</b>	390028	<b>Ref. No.</b>	63.7.0630
<b>description</b>	safety thermostat switch-off temp. 230°C 1-pole 16A probe ø 3mm probe L 155mm capillary pipe 890mm capillary pipe isolated 600mm gland nut probe SS		
<b>For models:</b>	F620, F640, TN30 PLUS		

PRODIGY / FIRT

control thermostats with operation switch

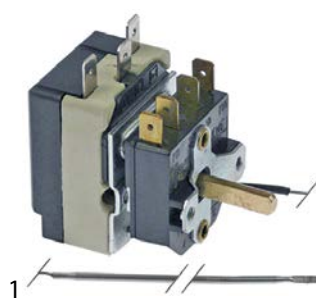

<b>Part No.</b>	390791	<b>Ref. No.</b>	63.7.0651
<b>description</b>	thermostat t.max. 270°C temperature range 63-270°C 1-pole 1CO 16A probe ø 3mm probe L 185mm capillary pipe 950mm capillary pipe isolated 55mm gland nut shaft ø 6x4.6mm shaft L 16.5mm shaft position upper rotation 270° outer switch 2NO		
<b>For models:</b>	PD 1020 L, PD 1020 LB, PD 1020 M, PD 1020 MB, PD 1020 R, PD 1020 RB, PD 2020 L, PD 2020 LB, PD 2020 M, PD 2020 MB, PD 2020 R, PD 2020 RB, PDV 3020 L, PDV 3020 R, PDV-3020-McDonalds, PM 1015 L, PM 1015 LB, PM 1015 R, PM 1015 RB, PM 2015 L, PM 2015 LB, PM 2015 R, PM 2015 RB, PS 2010 L, PS 2010 LB, PS 2010 R, PS 2010 RB, PS 2010 L, PS 2010 LB, PS 2010 R, PS 2010 RB, PSV 3010 L, PSV 3010 R		

switches and momentary switches

rocker/momentary rocker switches

30x22mm



<b>Part No.</b>	301061	<b>Ref. No.</b>	63.7.0861
<b>description</b>	rocker switch mounting measurements 30x22mm orange 2NO 250V 16A illuminated connection male faston 6.3mm ambient temperature max. 125/55°C protection IP40		
<b>For models:</b>	B800E, B830, B840, PT40, PT60, SEPC		



<b>Part No.</b>	345599	<b>Ref. No.</b>	63.7.0862
<b>description</b>	rocker switch mounting measurements 30x22mm orange/orange 1NO/1NO/indicator light 250V 16A illuminated connection male faston 6.3mm ambient temperature max. 85/125°C protection IP40		
<b>For models:</b>	B860, HD20, HD40, T920, T930		





			
1			
<b>Part No.</b>	301077	<b>Ref. No.</b>	63.7.0863
<b>description</b>	rocker switch mounting measurements 30x22mm orange/orange 1NO/indicator light 250V 16A illuminated connection male faston 6.3mm ambient temperature max. 100/55°C protection IP40		
<b>For models:</b>	VEC 510, VEC 520		

## push/momentary push switches

30x22mm

			
1			
<b>Part No.</b>	301086	<b>Ref. No.</b>	63.7.0860
<b>description</b>	push switch mounting measurements 30x22mm black 2NO 250V 12A 0-1 connection male faston 6.3mm ambient temperature max. 85/55°C protection IP54 with protective collar		
<b>For models:</b>	BM11, BM12, BM13, BM23, CW6, CW8, FE04, FE07, FE07T, FE77, FE77T		

## microswitches

pin-plunger actuated

M10

			
1			
<b>Part No.</b>	347216	<b>Ref. No.</b>	63.7.0880
<b>description</b>	microswitch with plunger thread M10x0.75 thread L 14mm 250V 10A 1CO connection male faston 6.3mm stroke 7.5mm mounting distance 22mm L 28mm ambient temperature max. 125°C type NR6K5 actuating force: 260g		
<b>For models:</b>	F620, F640, FE04, FE07, FE07T, FE77, FE77T		

## rotary switches

BRETER

rotary switches

			
1			
<b>Part No.</b>	347618	<b>Ref. No.</b>	63.7.0852
<b>description</b>	rotary switch 2 0-1 sets of contacts 2 type LE2-20-1752 600V 20A shaft ø 8x9mm shaft L 20mm shaft star-shaped connection screw		
<b>For models:</b>	B850, T920, T930		

			
1			
<b>Part No.</b>	345572	<b>Ref. No.</b>	63.7.0850
<b>description</b>	rotary switch 2 0-1 sets of contacts 2 type LE2-20-1752 690V 16A shaft ø 7x8mm shaft L 20mm shaft star-shaped connection screw clamp		
<b>For models:</b>	TN30, TN30 PLUS		

accessories

			
1			
<b>Part No.</b>	347619	<b>Ref. No.</b>	63.6.0281
<b>description</b>	knob with bezel 0-1		

## encoders and potentiometers

			
1			
<b>Part No.</b>	300138	<b>Ref. No.</b>	63.7.0628
<b>description</b>	potentiometer		

## lamps

## indicator lights

indicator lights 2-piece (lens and indicator lamp)

indicator light lenses

ø10mm (type SRZ-3)

			
1			
<b>Part No.</b>	359125	<b>Ref. No.</b>	57.2.9.9.0.01
<b>description</b>	indicator light housings mounting measurements ø10mm red round Qty 1 pcs		

ø12mm (type SDK-3)

			
1			
<b>Part No.</b>	359275	<b>Ref. No.</b>	51.2.9.99.00.0T
<b>description</b>	indicator light housings mounting measurements ø12mm clear Qty 1 pcs		





			
1			
<b>Part No.</b>	359277	<b>Ref. No.</b>	51.2.9.99.03.0T
<b>description</b>	indicator light housings mounting measurements ø12mm green Qty 1 pcs		

			
1			
<b>Part No.</b>	359276	<b>Ref. No.</b>	51.2.9.99.01.0T
<b>description</b>	indicator light housings mounting measurements ø12mm red Qty 1 pcs		

			
1			
<b>Part No.</b>	359278	<b>Ref. No.</b>	51.2.9.99.04.0T
<b>description</b>	indicator light housings mounting measurements ø12mm yellow Qty 1 pcs		

ø12mm (type SDY-3)			
			
1			
<b>Part No.</b>	359280	<b>Ref. No.</b>	41.2.0.0.0.00.0.0
<b>description</b>	indicator light housings mounting measurements ø12mm clear round Qty 1 pcs		

			
1			
<b>Part No.</b>	359262	<b>Ref. No.</b>	41.2.0.00.03.00
<b>description</b>	indicator light housings mounting measurements ø12mm green round Qty 1 pcs		

			
1			
<b>Part No.</b>	359261	<b>Ref. No.</b>	41.2.0.00.01.00
<b>description</b>	indicator light housings mounting measurements ø12mm red round Qty 1 pcs		

			
1			
<b>Part No.</b>	359260	<b>Ref. No.</b>	41.2.9.00.04.00
<b>description</b>	indicator light housings mounting measurements ø12mm yellow round Qty 1 pcs		

indicator lamps for socket type SRZ / SDK / SDY / SFK			
			
1			
<b>Part No.</b>	359130	<b>Ref. No.</b>	21.3.2.40.00.0T
<b>description</b>	indicator lamp 230V clear connection male faston 6.3mm ø 8mm		

indicator lights (complete)			
ø10mm			
with plug-in socket			
			
1			
<b>Part No.</b>	359139	<b>Ref. No.</b>	63.7.0811
<b>description</b>	indicator light ø 10mm green 230V connection male faston 6.3mm Qty 1 pcs		
<b>For models:</b>	F620, F640, TN30 PLUS		

			
1			
<b>Part No.</b>	359140	<b>Ref. No.</b>	63.7.0810
<b>description</b>	indicator light ø 10mm yellow 230V connection male faston 6.3mm Qty 1 pcs		
<b>For models:</b>	F620, F640		

ø12mm			
with screw socket			
			
1			
<b>Part No.</b>	359994	<b>Ref. No.</b>	51.F.2.H.0.00
<b>description</b>	indicator light ø 12mm 400V clear connection male faston 6.3mm		

			
1			
<b>Part No.</b>	359291	<b>Ref. No.</b>	51.F.2.H.7.03
<b>description</b>	indicator light ø 12mm 400V green connection male faston 6.3mm		

			
1			
<b>Part No.</b>	359292	<b>Ref. No.</b>	51.F.2.H.0.01
<b>description</b>	indicator light ø 12mm 400V red connection male faston 6.3mm		

			
1			
<b>Part No.</b>	359290	<b>Ref. No.</b>	51.F.2.H.0.04
<b>description</b>	indicator light ø 12mm 400V yellow connection male faston 6.3mm		



ø13mm

with plug-in socket

1

<b>Part No.</b>		<b>Ref. No.</b>	53.2.0.0.00.0.0
<b>description</b>	indicator light housings mounting measurements ø13mm clear round		



1

<b>Part No.</b>	359282	<b>Ref. No.</b>	53.2.0.0.03.0.0
<b>description</b>	indicator light housings mounting measurements ø13mm green round		



1

<b>Part No.</b>	359281	<b>Ref. No.</b>	53.2.0.0.04.0.0
<b>description</b>	indicator light housings mounting measurements ø13mm orange round		



1

<b>Part No.</b>	359283	<b>Ref. No.</b>	53.2.0.0.01.0.0
<b>description</b>	indicator light housings mounting measurements ø13mm red round		

30x22mm



1

<b>Part No.</b>	359157	<b>Ref. No.</b>	63.7.0820
<b>description</b>	indicator light mounting measurements 30x22mm 230V green connection male faston 6.3mm temp.-resist. 125/55°C type RL2		

**For models:** HD20, HD40, SE1, SE1M, SE2, SE2M, SEP, SEPC, SUV 66, T940, T960, TN30

**accessories for** 359157



<b>Part No.</b>	301036	<b>Ref. No.</b>	—
protective cover internal size 30x22mm for rocker switch mounting measurementsmm			



1

<b>Part No.</b>	359156	<b>Ref. No.</b>	63.7.0805
<b>description</b>	indicator light mounting measurements 30x22mm 230V yellow connection male faston 6.3mm temp.-resist. 125/55°C type RL2		

**For models:** SE1, SE1M, SE2, SE2M, SEP, SEPC, T940, T960



1

<b>Part No.</b>	359164	<b>Ref. No.</b>	63.7.0821
<b>description</b>	indicator light mounting measurements 30x22mm 230V green/white connection male faston 6.3mm temp.-resist. 125°C		
<b>For models:</b>	BM11, BM12, BM13, BM23, CW6, CW8, FE04, FE07, FE07T, FE77, FE77T, PD 1020 L, PD 1020 LB, PD 1020 M, PD 1020 MB, PD 1020 R, PD 1020 RB, PD 2020 L, PD 2020 LB, PD 2020 M, PD 2020 MB, PD 2020 R, PD 2020 RB, PDV 3020 L, PDV 3020 R, PDV-3020-McDonalds, PM 1015 L, PM 1015 LB, PM 1015 R, PM 1015 RB, PM 2015 L, PM 2015 LB, PM 2015 R, PM 2015 RB, PS 1010 L, PS 1010 LB, PS 1010 R, PS 1010 RB, PS 2010 L, PS 2010 LB, PS 2010 R, PS 2010 RB, PSV 3010 L, PSV 3010 R		

## timers

## mechanical timers



1

<b>Part No.</b>	350044	<b>Ref. No.</b>	63.7.0665 63.7.0666
<b>description</b>	timer C20 2-pole operation time 15min impulse mechanical 2NO at 250V 16A permanent position no shaft ø 6x4.6mm shaft 6x4.6mm shaft L 20mm mounting distance 28mm connection lateral for toaster		
<b>For models:</b>	FP36, FP36R, FP66R, T920, T930, T940, T960		
<b>accessories for</b>	350044		
	<b>Part No.</b>	110285	<b>Ref. No.</b> —
knob switch zero mark t.max.°C ø 40mm shaft ø 6x4.6mm shaft flat upper black			

## contactors

## ISKRA (FANAL)

## power contactors



1

<b>Part No.</b>	380213	<b>Ref. No.</b>	63.7.0890
<b>description</b>	power contactor resistive load 20A 230VAC (AC3/400V) 8.5A/5.5kW main contacts 3NO auxiliary contacts 1NO connection screw connection type Fanal DSL7 10 type ISKRA K07M 10		
<b>For models:</b>	FE07T, FE77T		



## transformers

### encapsulated transformers

#### PMA



1

<b>Part No.</b>	400583	<b>Ref. No.</b>	63.7.0701
<b>description</b>	transformer primary 230VAC secondary 24VAC 10VA secondary 0.4A connection screw 50Hz		
<b>For models:</b>	BM11, BM12, BM13, BM23, FE04, FE07, FE07T, FE44, FE77, FE77T, TN30 PLUS		

## electronics

### PCBs



1

<b>Part No.</b>	400579	<b>Ref. No.</b>	63.7.0627
<b>description</b>	PCB		
<b>For models:</b>	TN30 PLUS		



## evaporation and condensing trays

### condensing trays heated

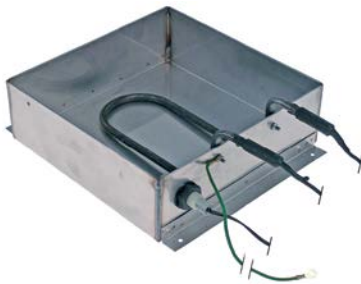
#### producer-specific





1

<b>Part No.</b>	750003	<b>Ref. No.</b>	750003	
<b>description</b>	condensing tray heated L 240mm W 240mm H 75mm 230V 650W connect with power contactor			
<b>spare parts for</b>	750003			
	<b>Part No.</b>	348139	<b>Ref. No.</b>	—
	float switch 250V 1A 1NO or 1NC thread M16x1.5 ø 17.4mm L 100.5mm mounting ø 28mm cable cable length 1500mm temp.-resist. -20 up to +90°C			
	<b>Part No.</b>	418732	<b>Ref. No.</b>	—
	heating element 650W 230V L 280mm W 95mm H 87mm L1 65mm L2 215mm cable length 1500mm connection distance 86mm tube ø 8.5mm heating circuits 1 immersion heater			

<b>accessories for</b>	750003			
	<b>Part No.</b>	380185	<b>Ref. No.</b>	—
	power relays Italiana Relè 230VAC 30A 1NO connection F6.3 bracket mounting dimensions 36.5x32.2x51.8mm manuf. no. A10-230AC-FA			



1

<b>Part No.</b>	750004	<b>Ref. No.</b>	750004	
<b>description</b>	condensing tray heated L 380mm W 240mm H 75mm 230V 750W with float switch			
<b>spare parts for</b>	750004			
	<b>Part No.</b>	348139	<b>Ref. No.</b>	—
	float switch 250V 1A 1NO or 1NC thread M16x1.5 ø 17.4mm L 100.5mm mounting ø 28mm cable cable length 1500mm temp.-resist. -20 up to +90°C			
	<b>Part No.</b>	418733	<b>Ref. No.</b>	—
	heating element 750W 230V L 430mm W 95mm H 98mm L1 85mm L2 345mm cable length 1500mm connection cable connection distance 86mm tube ø 8.5mm heating circuits 1 immersion heater			
<b>accessories for</b>	750004			
	<b>Part No.</b>	380185	<b>Ref. No.</b>	—
	power relays Italiana Relè 230VAC 30A 1NO connection F6.3 bracket mounting dimensions 36.5x32.2x51.8mm manuf. no. A10-230AC-FA			

## motors

### gear motors

#### for conveyor toaster



1

<b>Part No.</b>	499246	<b>Ref. No.</b>	63.7.0752
<b>description</b>	gear motor 24V H 85mm L 137mm W 65mm type K9119052 KENTA voltage DC shaft ø 6x8mm		
<b>For models:</b>	TN30 PLUS		



## for grills



1

<b>Part No.</b>	499209	<b>Ref. No.</b>	63.7.0751 old
<b>description</b>	gear motor KENTA type K9113069 23W 230V 50Hz 2.5rpm shaft ø 6x8mm L 108mm W 58mm H 66mm		

## miscellaneous



1

<b>Part No.</b>	500496	<b>Ref. No.</b>	63.7.0752 old
<b>description</b>	gear motor TRIAL type R5/G4.5 24V voltage DC shaft ø 5x8mm L 100mm W 70mm H 120mm for toaster		

## electric accessories

## terminals

## connection terminals with strain relief



1

<b>Part No.</b>	550356	<b>Ref. No.</b>	63.7.0543
<b>description</b>	power terminal block 2-pole max 450V max. 16A cable ø 15mm cross section 1.5mm <sup>2</sup>		
<b>For models:</b>	CW6, CW8, HD20, HD40, PT40, PT60, VEC 510, VEC 520		

## equipment-specific units

## for convection ovens/combi-steamers

## door mechanics

## accessories



1

<b>Part No.</b>	694840	<b>Ref. No.</b>	694840
<b>description</b>	guide bar SS L 725mm		

## for hot dog machines

## lids



1

<b>Part No.</b>	693066	<b>Ref. No.</b>	63.4.0401
<b>description</b>	lid for hot dog machine		
<b>For models:</b>	HD20, HD40		

## glass cylinders



1

<b>Part No.</b>	693067	<b>Ref. No.</b>	63.6.7010
<b>description</b>	glass cylinder ø 200mm H 204mm		
<b>For models:</b>	HD20, HD40		

## miscellaneous



1

<b>Part No.</b>	691359	<b>Ref. No.</b>	63.0.0113
<b>description</b>	mounting angle		



1 

<b>Part No.</b>	691358	<b>Ref. No.</b>	63.0.0112
<b>description</b>	mounting angle L 207mm		

water containers

1 

<b>Part No.</b>	693068	<b>Ref. No.</b>	63.4.0441
<b>description</b>	water container for hot dog machine		
<b>For models:</b>	HD20, HD40		

gear wheels

1 

<b>Part No.</b>	693062	<b>Ref. No.</b>	63.3.1003
<b>description</b>	gear wheel teeth 11 shaft intake ø 8mm ø 31mm hub ø 18mm stainless steel		
<b>For models:</b>	CW6, CW8		

for pizza ovens

firebricks

1 

<b>Part No.</b>	850014	<b>Ref. No.</b>	63.6.7401
<b>description</b>	firebrick L 410mm W 362mm H 15mm grooved delivery freight forwarding company only		

for rolling grills

pipes

bushes

1 

<b>Part No.</b>	693060	<b>Ref. No.</b>	63.3.0801
<b>description</b>	bushing PTFE		
<b>For models:</b>	CW6, CW8		

pipes

1 

<b>Part No.</b>	693059	<b>Ref. No.</b>	63.3.2101
<b>description</b>	pipe with gear wheel for roller grill		
<b>For models:</b>	CW6, CW8		

gear wheels

1 

<b>Part No.</b>	693062	<b>Ref. No.</b>	63.3.1003
<b>description</b>	gear wheel teeth 11 shaft intake ø 8mm ø 31mm hub ø 18mm stainless steel		
<b>For models:</b>	CW6, CW8		

for toasters

pliers

pliers

1 

<b>Part No.</b>	690010	<b>Ref. No.</b>	63.3.3095
<b>description</b>	plier for toaster H 180mm total length 100mm		
<b>For models:</b>	T920, T930, T940, T960		

knobs

universal knobs

1 

<b>Part No.</b>	110075	<b>Ref. No.</b>	63.7.0280
<b>description</b>	knob energy regulator 1-3 t.max.°C ø 50mm shaft ø 6x4.6mm shaft flat upper black		
<b>For models:</b>	SE1, SE1M		
<b>accessories for</b>	110075		
	<b>Part No.</b>	110135	<b>Ref. No.</b> —
	rosette knob up to ø 52mm		



## handles and hand wheels

## cylindrical handles

fixed



1

<b>Part No.</b>	540237	<b>Ref. No.</b>	63.6.0102
<b>description</b>	cylindrical handle thread M8 ø 23mm L 65mm		
<b>For models:</b>	SE1, SE1M, SE2, SE2M		

## hinges

## oven hinges



1

<b>Part No.</b>	690029	<b>Ref. No.</b>	35.249.70
<b>description</b>	torsion spring ø 25.8mm L2 71mm wire gauge ø 3.7mm L1 79mm L3 13mm		

## equipment feet and end caps

## screw-in feet



1

<b>Part No.</b>	691344	<b>Ref. No.</b>	63.6.0021
<b>description</b>	equipment foot thread M8 thread L 20mm ø 23mm H 12mm Qty 1 pcs		
<b>For models:</b>	BM11, BM12, BM13, BM23, CW6, CW8, HD20, HD40, PD 1020 L, PD 1020 LB, PD 1020 M, PD 1020 MB, PD 1020 R, PD 1020 RB, PD 2020 L, PD 2020 LB, PD 2020 M, PD 2020 MB, PD 2020 R, PD 2020 RB, PDV 3020 L, PDV 3020 R, PDV-3020-McDonalds, PM 1015 L, PM 1015 LB, PM 1015 R, PM 1015 RB, PM 2015 L, PM 2015 LB, PM 2015 R, PM 2015 RB, PS 1010 L, PS 1010 LB, PS 1010 R, PS 1010 RB, PS 2010 L, PS 2010 LB, PS 2010 R, PS 2010 RB, PSV 3010 L, PSV 3010 R, PT40, PT60, TN30, TN30 PLUS, VEC 510, VEC 520		

## shelves and shelf rails

## grates

producer-specific

1

<b>Part No.</b>	970301	<b>Ref. No.</b>	63.3.3002
<b>description</b>	grate		
<b>For models:</b>	SE2		



1

<b>Part No.</b>	970305	<b>Ref. No.</b>	63.3.0003
<b>description</b>	grate W 370mm D 230mm chrome-plated steel		

## transmission technology and ball bearings

## chains

## roller chains 05B-1 single



1

<b>Part No.</b>	693063	<b>Ref. No.</b>	63.3.1100
<b>description</b>	chain DIN/ISO 05 B-1 splitting 8mm links 35 internal width 3mm roller ø 5mm single closed		
<b>For models:</b>	CW6		



1

<b>Part No.</b>	693064	<b>Ref. No.</b>	63.3.1101
<b>description</b>	chain DIN/ISO 05 B-1 splitting 8mm links 52 internal width 3mm roller ø 5mm single		
<b>For models:</b>	CW8		



## springs

## torsion springs



<b>Part No.</b>	690081	<b>Ref. No.</b>	63.3.0853
<b>description</b>	torsion spring $\phi$ 19.4mm L2 36mm wire gauge $\phi$ 3.3mm mounting pos. left L1 42mm L3 36mm Qty 1 pcs		
<b>For models:</b>	PD 1020 L, PD 1020 M, PD 1020 R, PM 1015 L, PM 1015 R, PS 1010 L, PS 1010 R		
<b>accessories for</b>	690081		
	<b>Part No.</b>	690080	<b>Ref. No.</b> 63.3.0852
	torsion spring $\phi$ 19.4mm L2 37mm wire gauge $\phi$ 3.4mm mounting pos. right L1 42mm L3 37mm Qty 1 pcs		



<b>Part No.</b>	690080	<b>Ref. No.</b>	63.3.0852
<b>description</b>	torsion spring $\phi$ 19.4mm L2 37mm wire gauge $\phi$ 3.4mm mounting pos. right L1 42mm L3 37mm Qty 1 pcs		
<b>For models:</b>	PD 1020 L, PD 1020 M, PD 1020 R, PM 1015 L, PM 1015 R, PS 1010 L, PS 1010 R		
<b>accessories for</b>	690080		
	<b>Part No.</b>	690081	<b>Ref. No.</b> 63.3.0853
	torsion spring $\phi$ 19.4mm L2 36mm wire gauge $\phi$ 3.3mm mounting pos. left L1 42mm L3 36mm Qty 1 pcs		



<b>Part No.</b>	700731	<b>Ref. No.</b>	63.3.0862
<b>description</b>	torsion spring $\phi$ 21mm L1 120mm L2 63mm L3 63mm wire gauge $\phi$ 3mm folding grill		
<b>For models:</b>	PDV-3020-McDonalds		

	<b>Part No.</b>	700084	<b>Ref. No.</b>	63.3.0861
<b>description</b>	torsion spring $\phi$ 22mm L1 119mm L2 64mm L3 64mm wire gauge $\phi$ 3.5mm			
<b>For models:</b>	PD 2020 L, PD 2020 M, PD 2020 R, PDV 3020 L, PDV 3020 R, PM 2015 L, PM 2015 R, PS 2010 L, PS 2010 R, PSV 3010 L, PSV 3010 R			

	<b>Part No.</b>	690029	<b>Ref. No.</b>	35.249.70
<b>description</b>	torsion spring $\phi$ 25.8mm L2 71mm wire gauge $\phi$ 3.7mm L1 79mm L3 13mm			

## compression springs

	<b>Part No.</b>	700176	<b>Ref. No.</b>	63.3.0870
<b>description</b>	compression spring $\phi$ 19.5mm L 45mm wire gauge $\phi$ 1.5mm			
<b>For models:</b>	HD20, HD40, PT40, PT60			

## fastening material

## fasteners

## retaining rings

DIN 471

	<b>Part No.</b>	693061	<b>Ref. No.</b>	63.3.0505
<b>description</b>	retaining ring shaft $\phi$ 25mm thickness 1.2mm steel DIN 471			
<b>For models:</b>	CW6, CW8			



**GASTRO**PARTS.COM

