



**GASTROPARTS**

# Carimali

- [EN]** Equipment
- [DE]** Geräte
- [ES]** Aparatos
- [FR]** Équipement
- [IT]** Attrezzature
- [PL]** Urządzenia
- [RU]** Оборудование

✉ [gastroparts@gastroparts.com](mailto:gastroparts@gastroparts.com)

☎ tel. +48 56 657 00 66

📘 [fb.com/gastroparts.global](https://fb.com/gastroparts.global)



**GASTROPARTS.COM**













# heating elements

## heating elements for coffee machine







			
1			
<b>Part No.</b>	417452	<b>Ref. No.</b>	N/A
<b>description</b>	heating element 1600W 230V heating circuits 1 thread 1¼" L 160mm W 32mm H 23mm tube ø 8mm thermostat sleeves ø 6.6mm length thermostat sleeves 140mm connection M4 immersion heater flange with thread		
<b>accessories for</b>	417452		
	<b>Part No.</b>	510405	<b>Ref. No.</b> —
	flat gasket fibre ED ø 56mm ID ø 42mm thickness 2mm for thread 1¼" Qty 1 pcs		
	<b>Part No.</b>	528021	<b>Ref. No.</b> —
	flat gasket PTFE ED ø 53mm ID ø 42.5mm thickness 3mm Qty 1 pcs equiv. no. 12001/02286 suitable for Astoria/Aurora/Brasilia/Wega		

			
1			
<b>Part No.</b>	417045	<b>Ref. No.</b>	N/A
<b>description</b>	heating element 1800W 230V heating circuits 1 thread 1¼" L 135mm W 36mm H 39mm tube ø 8.5mm connection male faston 6.3mm immersion heater flange with thread		
<b>accessories for</b>	417045		
	<b>Part No.</b>	510405	<b>Ref. No.</b> —
	flat gasket fibre ED ø 56mm ID ø 42mm thickness 2mm for thread 1¼" Qty 1 pcs		
	<b>Part No.</b>	528021	<b>Ref. No.</b> —
	flat gasket PTFE ED ø 53mm ID ø 42.5mm thickness 3mm Qty 1 pcs equiv. no. 12001/02286 suitable for Astoria/Aurora/Brasilia/Wega		

			
1			
<b>Part No.</b>	417046	<b>Ref. No.</b>	95.00985
<b>description</b>	heating element 2000W 230V heating circuits 1 thread 1¼" L 200mm W 32mm H 26mm tube ø 8.5mm thermostat sleeves ø 6.5mm length thermostat sleeves 152mm connection M4 immersion heater connection length 25mm flange with thread		
<b>accessories for</b>	417046		
	<b>Part No.</b>	510405	<b>Ref. No.</b> —
	flat gasket fibre ED ø 56mm ID ø 42mm thickness 2mm for thread 1¼" Qty 1 pcs		
	<b>Part No.</b>	528021	<b>Ref. No.</b> —
	flat gasket PTFE ED ø 53mm ID ø 42.5mm thickness 3mm Qty 1 pcs equiv. no. 12001/02286 suitable for Astoria/Aurora/Brasilia/Wega		

			
1			
<b>Part No.</b>	417048	<b>Ref. No.</b>	N/A
<b>description</b>	heating element 2400W 230V heating circuits 2 thread 1¼" L 235mm W 34mm H 24mm tube ø 8.4mm connection male faston 6.3mm immersion heater connection length 31mm flange with thread WS 37		
<b>accessories for</b>	417048		
	<b>Part No.</b>	510405	<b>Ref. No.</b> —
	flat gasket fibre ED ø 56mm ID ø 42mm thickness 2mm for thread 1¼" Qty 1 pcs		

<b>accessories for</b>	417048		
	<b>Part No.</b>	528021	<b>Ref. No.</b> —
	flat gasket PTFE ED ø 53mm ID ø 42.5mm thickness 3mm Qty 1 pcs equiv. no. 12001/02286 suitable for Astoria/Aurora/Brasilia/Wega		







			
1			
<b>Part No.</b>	417616	<b>Ref. No.</b>	96.00559
<b>description</b>	heating element 2800W 230V heating circuits 3 mounting ø 35mm hole distance 58mm L 153mm W 30mm H 30mm hole ø 10mm thermostat sleeves ø 4mm length thermostat sleeves 140mm number of thermostat sleeves 1 thermostat sleeve centred, adjacent tube ø 6mm connection M3 immersion heater 3 hole flange		
<b>accessories for</b>	417616		
	<b>Part No.</b>	521077	<b>Ref. No.</b> 87.05003.00.19
	O-ring Viton thickness 5.34mm ID ø 37.47mm Qty 1 pcs		
	<b>Part No.</b>	527169	<b>Ref. No.</b> 92.00005
	hexagonal nut thread M3 H 2.8mm WS 5.5 brass Qty 1 pcs		
	<b>Part No.</b>	528529	<b>Ref. No.</b> 93.00007
	plain washer ID ø 3.5mm ED ø 6.6mm thickness 0.5mm brass Qty 1 pcs		
	<b>Part No.</b>	560036	<b>Ref. No.</b> —
	tooth lock washer ID ø 3.1mm ED ø 5.7mm SS Qty 10 pcs		
	<b>Part No.</b>	560572	<b>Ref. No.</b> 95.01606
	contact bridge		

			
1			
<b>Part No.</b>	417250	<b>Ref. No.</b>	96.00482
<b>description</b>	heating element 2800W 230V heating circuits 3 mounting ø 39mm hole distance 58mm L 191mm W 33mm H 32mm hole ø 10mm length thermostat sleeves 153mm thermostat sleeves ø 5mm number of thermostat sleeves 1 thermostat sleeve eccentric, clinging tube ø 8mm connection 3 immersion heater 3 hole flange		
<b>For models:</b>	E9-COF, E9-Espresso, E9-LM, EtaBeta-V2-COF, EtaBeta-V2-COF-Display, EtaBeta-V2-LM, EtaBeta-V2-LM-Display, Kicco-COF, Kicco-Espresso, Kicco-LM, TemaStyle		







			
1			
<b>Part No.</b>	417036	<b>Ref. No.</b>	N/A
<b>description</b>	heating element 2800W 230V heating circuits 3 mounting ø 51mm hole distance 63mm L 350mm W 36mm H 70mm hole ø 9mm thermostat sleeves ø 7mm length thermostat sleeves 150mm number of thermostat sleeves 1 thermostat sleeve eccentric, non clinging tube ø 8mm connection male faston 6.3mm immersion heater 3 hole flange		

1 electric components







			
1			
<b>Part No.</b>	417047	<b>Ref. No.</b>	95.01348.10
<b>description</b>	heating element 3000W 230V heating circuits 3 thread 1¼" L 405mm W 29mm H 29mm tube ø 8.5mm thermostat sleeves ø 6.5mm length thermostat sleeves 195mm connection M3 immersion heater flange with thread		
<b>spare parts for</b>	417047		
	<b>Part No.</b>	510405	<b>Ref. No.</b> —
<b>description</b>	flat gasket fibre ED ø 56mm ID ø 42mm thickness 2mm for thread 1¼" Qty 1 pcs		
<b>accessories for</b>	417047		
	<b>Part No.</b>	527169	<b>Ref. No.</b> 92.00005
<b>description</b>	hexagonal nut thread M3 H 2.8mm WS 5.5 brass Qty 1 pcs		
	<b>Part No.</b>	528021	<b>Ref. No.</b> —
<b>description</b>	flat gasket PTFE ED ø 53mm ID ø 42.5mm thickness 3mm Qty 1 pcs equiv. no. 12001/02286 suitable for Astoria/Aurora/Brasilia/Wega		
	<b>Part No.</b>	560110	<b>Ref. No.</b> —
<b>description</b>	plain washer ID ø 3.2mm ED ø 7mm thickness 0.5mm SS Qty 20 pcs DIN 125A for thread M3		
	<b>Part No.</b>	560130	<b>Ref. No.</b> —
<b>description</b>	hexagonal nut thread M3 H 2.4mm WS 5.5 SS DIN/ISO DIN 934 / ISO 4032/8673 Qty 20 pcs		

			
1			
<b>Part No.</b>	417251	<b>Ref. No.</b>	96.00496
<b>description</b>	heating element 3500W 230V heating circuits 3 mounting ø 39mm hole distance 58mm L 380mm W 33mm H 33mm hole ø 10mm length thermostat sleeves 188mm thermostat sleeves ø 5mm number of thermostat sleeves 1 thermostat sleeve eccentric, clinging tube ø 8mm connection M3 immersion heater 3 hole flange		
<b>For models:</b>	E9-COF, E9-Espresso, E9-LM, EtaBeta-V2-COF, EtaBeta-V2-COF-Display, EtaBeta-V2-LM, EtaBeta-V2-LM-Display, Kicco-COF, Kicco-Espresso, Kicco-LM, TemaStyle		

			
1			
<b>Part No.</b>	417617	<b>Ref. No.</b>	96.00561
<b>description</b>	heating element 4500W 230V heating circuits 3 mounting ø 35mm hole distance 58mm L 265mm W 30mm H 30mm hole ø 10mm length thermostat sleeves 188mm thermostat sleeves ø 5mm number of thermostat sleeves 1 thermostat sleeve centred, adjacent tube ø 6mm connection M3 immersion heater 3 hole flange		
<b>accessories for</b>	417617		
	<b>Part No.</b>	521077	<b>Ref. No.</b> 87.05003.00.19
<b>description</b>	O-ring Viton thickness 5.34mm ID ø 37.47mm Qty 1 pcs		
	<b>Part No.</b>	527169	<b>Ref. No.</b> 92.00005
<b>description</b>	hexagonal nut thread M3 H 2.8mm WS 5.5 brass Qty 1 pcs		
	<b>Part No.</b>	528529	<b>Ref. No.</b> 93.00007
<b>description</b>	plain washer ID ø 3.5mm ED ø 6.6mm thickness 0.5mm brass Qty 1 pcs		
	<b>Part No.</b>	560036	<b>Ref. No.</b> —
<b>description</b>	tooth lock washer ID ø 3.1mm ED ø 5.7mm SS Qty 10 pcs		
	<b>Part No.</b>	560572	<b>Ref. No.</b> 95.01606
<b>description</b>	contact bridge		

			
1			
<b>Part No.</b>	417252	<b>Ref. No.</b>	96.00505
<b>description</b>	heating element 4500W 230V heating circuits 3 mounting ø 39mm hole distance 58mm L 380mm W 33mm H 33mm hole ø 10mm length thermostat sleeves 190mm thermostat sleeves ø 5mm number of thermostat sleeves 1 thermostat sleeve eccentric, clinging tube ø 8mm connection M3 immersion heater 3 hole flange		
<b>For models:</b>	E9-COF, E9-Espresso, E9-LM, EtaBeta-V2-COF, EtaBeta-V2-COF-Display, EtaBeta-V2-LM, EtaBeta-V2-LM-Display, Kicco-COF, Kicco-Espresso, Kicco-LM, TemaStyle		

			
1			
<b>Part No.</b>	417253	<b>Ref. No.</b>	96.00495
<b>description</b>	heating element 4500W 230V heating circuits 3 mounting ø 39mm hole distance 58mm L 630mm W 33mm H 33mm hole ø 10mm length thermostat sleeves 200mm thermostat sleeves ø 5mm number of thermostat sleeves 1 thermostat sleeve eccentric, clinging tube ø 8mm connection M3 immersion heater 3 hole flange		

			
1			
<b>Part No.</b>	417345	<b>Ref. No.</b>	95.01202
<b>description</b>	heating element 5000W 230V heating circuits 3 thread 1¼" L 605mm W 34mm H 30mm tube ø 8mm thermostat sleeves ø 6.5mm length thermostat sleeves 200mm number of thermostat sleeves 1 thermostat sleeve not clinging connection M4 immersion heater connection length 28mm flange with thread		
<b>accessories for</b>	417345		
	<b>Part No.</b>	510405	<b>Ref. No.</b> —
<b>description</b>	flat gasket fibre ED ø 56mm ID ø 42mm thickness 2mm for thread 1¼" Qty 1 pcs		
	<b>Part No.</b>	528021	<b>Ref. No.</b> —
<b>description</b>	flat gasket PTFE ED ø 53mm ID ø 42.5mm thickness 3mm Qty 1 pcs equiv. no. 12001/02286 suitable for Astoria/Aurora/Brasilia/Wega		

## accessories

## hexagonal nuts

			
1			
<b>Part No.</b>	527169	<b>Ref. No.</b>	92.00005
<b>description</b>	hexagonal nut thread M3 H 2.8mm WS 5.5 brass Qty 1 pcs		

## tooth lock washers

			
1			
<b>Part No.</b>	560571	<b>Ref. No.</b>	93.00013
<b>description</b>	tooth lock washer ID ø 3.3mm ED ø 6.2mm zinc-coated steel DIN/ISO Qty 1 pcs for thread M3		



sealing washers

fibre gaskets

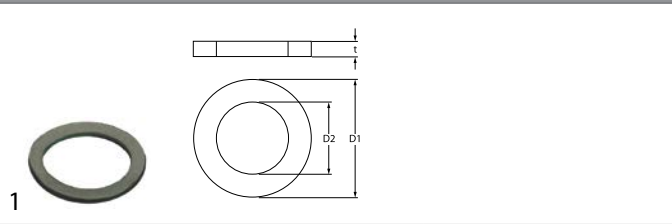

<b>Part No.</b>	528017	<b>Ref. No.</b>	N/A
<b>description</b>	flat gasket fibre ED ø 53mm ID ø 42mm thickness 2mm for thread 1¼" Qty 1 pcs		

PTFE gaskets

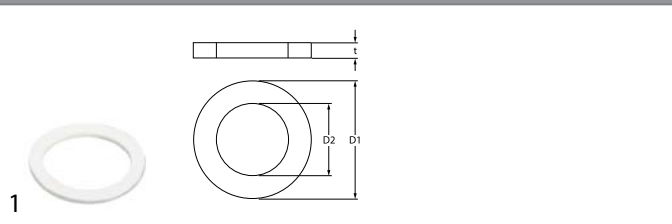

<b>Part No.</b>	528022	<b>Ref. No.</b>	N/A
<b>description</b>	flat gasket PTFE ED ø 52mm ID ø 41mm thickness 2mm size 1¼" Qty 1 pcs suitable for CARIMALI, FAEMA, MARZOCCO, PAVONI		



<b>Part No.</b>	560572	<b>Ref. No.</b>	95.01606
<b>description</b>	contact bridge		

thermostats

control and safety thermostats

EGO

safety thermostats

55.32\_ series



<b>Part No.</b>	390324	<b>Ref. No.</b>	95.01594
<b>description</b>	safety thermostat switch-off temp. 169°C 3-pole 3NC 20A probe ø 4mm probe L 128mm capillary pipe 890mm capillary pipe isolated 210/210mm gland nut probe SS		
<b>For models:</b>	E9-COF, E9-Espresso, E9-LM, EtaBeta-V2-COF, EtaBeta-V2-COF-Display, EtaBeta-V2-LM, EtaBeta-V2-LM-Display, Kicco-COF, Kicco-Espresso, Kicco-LM, TemaStyle		

switches and momentary switches

push/momentary push switches

30x22mm

<b>Part No.</b>	301082	<b>Ref. No.</b>	95.01783
<b>description</b>	push switch mounting measurements 30x22mm green 2NO 250V 12A connection male faston 6.3mm ambient temperature max. 85/55°C protection IP54 with protective collar		
<b>For models:</b>	E9-COF, E9-Espresso, E9-LM, Kicco-COF, Kicco-Espresso, Kicco-LM, TemaStyle		

system switches (ROLD)

<b>Part No.</b>	347181	<b>Ref. No.</b>	95.01735	
<b>description</b>	push button size 13x17mm chrome-plated			
<b>For models:</b>	E9-COF, E9-Espresso, E9-LM, EtaBeta-V2-COF, EtaBeta-V2-COF-Display, EtaBeta-V2-LM, EtaBeta-V2-LM-Display, Kicco-COF, Kicco-Espresso, Kicco-LM, TemaStyle			
<b>accessories for</b>	347181			
	<b>Part No.</b>	347182	<b>Ref. No.</b>	—
				element holder mounting measurements 20.6x16.4mm chrome-plated arched for push buttons 13x17mm

<b>Part No.</b>	345720	<b>Ref. No.</b>	96.00786
<b>description</b>	switch 2NO 250V 16A connection male faston 6.3mm		
<b>For models:</b>	TemaStyle		



## system switches

## CARIMALI

## push buttons



1

<b>Part No.</b>	347181	<b>Ref. No.</b>	95.01735
<b>description</b>	push button size 13x17mmmm chrome-plated		
<b>For models:</b>	E9-COF, E9-Espresso, E9-LM, EtaBeta-V2-COF, EtaBeta-V2-COF-Display, EtaBeta-V2-LM, EtaBeta-V2-LM-Display, Kicco-COF, Kicco-Espresso, Kicco-LM, TemaStyle		
<b>accessories for</b>	347181		
	<b>Part No.</b>	347182	<b>Ref. No.</b> —
	element holder mounting measurements 20.6x16.4mm chrome-plated arched for push buttons 13x17mm		

## element holders



1

<b>Part No.</b>	526339	<b>Ref. No.</b>	37.00726
<b>description</b>	frame for switch black plastic		
<b>For models:</b>	E9-COF, E9-Espresso, E9-LM, EtaBeta-V2-COF, EtaBeta-V2-COF-Display, EtaBeta-V2-LM, EtaBeta-V2-LM-Display, Kicco-COF, Kicco-Espresso, Kicco-LM, TemaStyle		

## switches



1

<b>Part No.</b>	345720	<b>Ref. No.</b>	96.00786
<b>description</b>	switch 2NO 250V 16A connection male faston 6.3mm		
<b>For models:</b>	TemaStyle		

## contactors

## MOELLER/EATON

## power contactors



1

<b>Part No.</b>	380497	<b>Ref. No.</b>	96.00807
<b>description</b>	power contactor resistive load 20A 230VAC (AC3/400V) 9A/4kW main contacts 4NO auxiliary contacts connection screw connection type DILEM 4		
<b>For models:</b>	E9-COF, E9-Espresso, E9-LM, EtaBeta-V2-COF-Display, EtaBeta-V2-LM-Display, Kicco-COF, Kicco-Espresso, Kicco-LM, TemaStyle		

## relays

## power relays

## with bracket mounting



1

<b>Part No.</b>	380808	<b>Ref. No.</b>	96.00032
<b>description</b>	power relays FINDER 230VAC 16A 3CO connection male faston 6.3mm bracket mounting manuf. no. 62.83.8.230.0000		
<b>For models:</b>	E9-COF, E9-Espresso, E9-LM, EtaBeta-V2-COF-Display, EtaBeta-V2-LM-Display, Kicco-COF, Kicco-Espresso, Kicco-LM, TemaStyle		

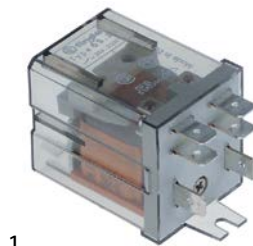

1

<b>Part No.</b>	380900	<b>Ref. No.</b>	96.00590
<b>description</b>	power relays FINDER 230VAC 20A 1NO/1NC connection F6.3 bracket mounting dimensions 36.5x32.2x51.8mm manuf. no. 65.31.8.230.0000 2-pole		
<b>For models:</b>	E9-COF, E9-Espresso, E9-LM, EtaBeta-V2-COF-Display, EtaBeta-V2-LM-Display, Kicco-COF, Kicco-Espresso, Kicco-LM, TemaStyle		



level relays

GICAR



1

<b>Part No.</b>	402327	<b>Ref. No.</b>	96.00470
<b>description</b>	level controller 230V voltage AC type RL30/3ES/F/G		
<b>For models:</b>	E9-COF, E9-Espresso, E9-LM, EtaBeta-V2-COF-Display, EtaBeta-V2-LM-Display, Kicco-COF, Kicco-Espresso, Kicco-LM, TemaStyle		
<b>accessories for</b>	402327		
	<b>Part No.</b>	526322	<b>Ref. No.</b> 03.00999
	cable L 100mm plug type Faston 6.3mm		



1

<b>Part No.</b>	526316	<b>Ref. No.</b>	96.00753
<b>description</b>	display espresso machine Espresso9 L 135mm W 44mm		
<b>For models:</b>	E9-Espresso		



1

<b>Part No.</b>	526315	<b>Ref. No.</b>	96.00724
<b>description</b>	display espresso machine KICCO COF-LM L 122mm W 44mm		
<b>For models:</b>	EtaBeta-V2-COF, EtaBeta-V2-COF-Display, EtaBeta-V2-LM, EtaBeta-V2-LM-Display, Kicco-COF, Kicco-Espresso, Kicco-LM		

probes

producer-specific probes

probes



1

<b>Part No.</b>	526337	<b>Ref. No.</b>	87.00087+96.05151 96.00600
<b>description</b>	probe NTC 47kOhm cable PTFE probe -40 up to +125°C cable -40 up to +250°C connection plug thread 1/4" probe ø6.5x25mm cable length 0.24m		
<b>For models:</b>	E9-COF, E9-Espresso, E9-LM, EtaBeta-V2-COF, EtaBeta-V2-COF-Display, EtaBeta-V2-LM, EtaBeta-V2-LM-Display, Kicco-COF, Kicco-Espresso, Kicco-LM, TemaStyle		



1

<b>Part No.</b>	403514	<b>Ref. No.</b>	96.00841
<b>description</b>	PCB coffee machine Armonia V2 L 270mm W 134mm		

electronics

PCBs



1

<b>Part No.</b>	526302	<b>Ref. No.</b>	96.00718.CA
<b>description</b>	display coffee machine TEMA STYLE L 80mm W 36mm		
<b>For models:</b>	TemaStyle		



1

<b>Part No.</b>	402325	<b>Ref. No.</b>	96.00771
<b>description</b>	central unit 3 relays 230V voltage AC		
<b>For models:</b>	E9-COF, E9-Espresso, E9-LM, EtaBeta-V2-COF, EtaBeta-V2-COF-Display, EtaBeta-V2-LM, EtaBeta-V2-LM-Display, Kicco-COF, Kicco-Espresso, Kicco-LM, TemaStyle		





			
1			
<b>Part No.</b>	402326	<b>Ref. No.</b>	96.00750
<b>description</b>	central unit 6 relays 230V voltage AC		
<b>For models:</b>	E9-COF, E9-Espresso, E9-LM, EtaBeta-V2-COF, EtaBeta-V2-COF-Display, EtaBeta-V2-LM, EtaBeta-V2-LM-Display, Kicco-COF, Kicco-Espresso, Kicco-LM, TemaStyle		

			
1			
<b>Part No.</b>	526321	<b>Ref. No.</b>	96.00821
<b>description</b>	control box 3-group for coffee machine 230V type 3d5 MAESTRO DELUXE SLAVE 64KB		
<b>For models:</b>	E9-COF, E9-Espresso, E9-LM, Kicco-COF, Kicco-Espresso, Kicco-LM, TemaStyle		

## keypads

## front foils

			
1			
<b>Part No.</b>	526303	<b>Ref. No.</b>	33.00287
<b>description</b>	front foil L 132mm W 41mm		
<b>For models:</b>	E9-LM		

			
1			
<b>Part No.</b>	526306	<b>Ref. No.</b>	33.00288
<b>description</b>	front foil L 132mm W 41mm		
<b>For models:</b>	E9-COF, E9-Espresso, E9-LM		

			
1			
<b>Part No.</b>	526312	<b>Ref. No.</b>	33.00286
<b>description</b>	front foil L 132mm W 41mm		
<b>For models:</b>	E9-COF		

			
1			
<b>Part No.</b>	526313	<b>Ref. No.</b>	33.00289
<b>description</b>	front foil L 132mm W 41mm		
<b>For models:</b>	E9-COF, E9-Espresso		

			
1			
<b>Part No.</b>	526304	<b>Ref. No.</b>	33.00300
<b>description</b>	front foil L 178mm W 51mm		
<b>For models:</b>	EtaBeta-V2-COF, EtaBeta-V2-COF-Display, EtaBeta-V2-LM, EtaBeta-V2-LM-Display, Kicco-COF, Kicco-Espresso, Kicco-LM		

			
1			
<b>Part No.</b>	526305	<b>Ref. No.</b>	33.00303
<b>description</b>	front foil L 178mm W 51mm		
<b>For models:</b>	EtaBeta-V2-COF, EtaBeta-V2-LM, Kicco-COF, Kicco-Espresso, Kicco-LM		

			
1			
<b>Part No.</b>	526307	<b>Ref. No.</b>	33.00301
<b>description</b>	front foil L 178mm W 51mm		
<b>For models:</b>	EtaBeta-V2-COF, EtaBeta-V2-LM, Kicco-COF, Kicco-Espresso, Kicco-LM		

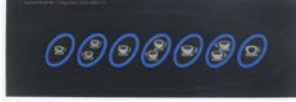
			
1			
<b>Part No.</b>	526308	<b>Ref. No.</b>	33.00306
<b>description</b>	front foil L 178mm W 51mm		
<b>For models:</b>	EtaBeta-V2-COF, EtaBeta-V2-COF-Display		

			
1			
<b>Part No.</b>	526309	<b>Ref. No.</b>	33.00308
<b>description</b>	front foil L 178mm W 51mm		
<b>For models:</b>	EtaBeta-V2-LM, EtaBeta-V2-LM-Display		

			
1			
<b>Part No.</b>	526310	<b>Ref. No.</b>	33.00305
<b>description</b>	front foil L 178mm W 51mm		
<b>For models:</b>	EtaBeta-V2-COF, EtaBeta-V2-COF-Display		



1			
<b>Part No.</b>	526311	<b>Ref. No.</b>	33.00302
<b>description</b>	front foil L 178mm W 51mm		
<b>For models:</b>	EtaBeta-V2-COF, EtaBeta-V2-LM, Kicco-COF, Kicco-Espresso, Kicco-LM		

1			
<b>Part No.</b>	526317	<b>Ref. No.</b>	33.00307
<b>description</b>	front foil L 178mm W 51mm		
<b>For models:</b>	E9-LM, EtaBeta-V2-LM, EtaBeta-V2-LM-Display		

### membrane keypads

1			
<b>Part No.</b>	401417	<b>Ref. No.</b>	96.00369
<b>description</b>	membrane keypad buttons 3		

1			
<b>Part No.</b>	526314	<b>Ref. No.</b>	02.02337
<b>description</b>	membrane keypad L 152mm W 32mm		
<b>For models:</b>	TemaStyle		

1			
<b>Part No.</b>	526320	<b>Ref. No.</b>	02.02338
<b>description</b>	membrane keypad L 152mm W 32mm		
<b>For models:</b>	TemaStyle		

### keypad units

1			
<b>Part No.</b>	526300	<b>Ref. No.</b>	96.00751
<b>description</b>	keypad unit buttons 6 L 135mm W 44mm		
<b>For models:</b>	E9-COF, E9-Espresso, E9-LM		

1			
<b>Part No.</b>	526301	<b>Ref. No.</b>	96.00725
<b>description</b>	keypad unit buttons 7 L 162mm W 38mm		
<b>For models:</b>	EtaBeta-V2-COF, EtaBeta-V2-COF-Display, EtaBeta-V2-LM, EtaBeta-V2-LM-Display, Kicco-COF, Kicco-Espresso, Kicco-LM		

### solenoïd valves

#### solenoïd valves (water)

metal			
PARKER			
2-way			
N74.BV series			

1			
<b>Part No.</b>	374061	<b>Ref. No.</b>	96.00621
<b>description</b>	solenoid valve brass 2-ways 230VAC connection 1/8" L 30mm DN 2mm -10 up to 140°C PARKER coil type WB4.5 membranes FKM (water/steam) p max 15bar p min 0bar 50/60Hz		

#### VE-125 series

1			
<b>Part No.</b>	370202	<b>Ref. No.</b>	95.01175
<b>description</b>	solenoid valve 2-ways 230VAC connection DN 2.5mm slide-on receptacle DIN -20° up to 130°C PARKER type series VE-125 coil type ZB09 membranes FKM (water) p max 10bar flange 32x32mm		
<b>spare parts for</b>	370202		
	<b>Part No.</b>	371029	<b>Ref. No.</b>
	solenoid coil PARKER 230VAC 9VA coil type ZB09 seat ø 14mm H 33mm W 34mm D 43mm		
<b>accessories for</b>	370202		
	<b>Part No.</b>	371090	<b>Ref. No.</b>
	power socket plug type DIN 43650A screw		
	<b>Part No.</b>	532553	<b>Ref. No.</b>
	O-ring silicone thickness 1.5mm ID ø 13.15mm Qty 1 pcs		
	<b>Part No.</b>	532554	<b>Ref. No.</b>
	O-ring silicone thickness 1.5mm ID ø 4.1mm Qty 1 pcs		







## E-146 series



1

<b>Part No.</b>	370206	<b>Ref. No.</b>	95.01176
<b>description</b>	solenoid valve 2-ways 230VAC connection 1/8" L 40mm DN 2.5mm slide-on receptacle DIN -20° up to 130°C PARKER type series VE-146 coil type ZB09 membranes FKM (water) p max 15bar p min 0bar		
<b>For models:</b>	E9-COF, E9-Espresso, E9-LM, EtaBeta-V2-COF, EtaBeta-V2-COF-Display, EtaBeta-V2-LM, EtaBeta-V2-LM-Display, Kicco-COF, Kicco-Espresso, Kicco-LM, TemaStyle		
<b>spare parts for</b>	370206		
	<b>Part No.</b>	371029	<b>Ref. No.</b> —
	solenoid coil PARKER 230VAC 9VA coil type ZB09 seat ø 14mm H 33mm W 34mm D 43mm		
<b>accessories for</b>	370206		
	<b>Part No.</b>	371090	<b>Ref. No.</b> —
	power socket plug type DIN 43650A screw		

## 3-way

## N79.6QV series



1

<b>Part No.</b>	374062	<b>Ref. No.</b>	96.00620
<b>description</b>	solenoid valve brass 3-ways 230VAC connection 1/8" L 30mm DN 1mm -10 up to 140°C PARKER coil type WB4.5 membranes FKM (water/steam) p max 15bar p min 0bar 50/60Hz		

## VE-141 series



1

<b>Part No.</b>	370550	<b>Ref. No.</b>	96.00203
<b>description</b>	solenoid valve 3-ways 230VAC connection 1/4" L 40mm DN 3mm slide-on receptacle DIN -20° up to 130°C coil type ZB09 membranes FKM (water) p max 3bar		
<b>For models:</b>	E9-COF, E9-Espresso, E9-LM, EtaBeta-V2-COF, EtaBeta-V2-COF-Display, EtaBeta-V2-LM, EtaBeta-V2-LM-Display, Kicco-COF, Kicco-Espresso, Kicco-LM, TemaStyle		

## VE-141R series



1

<b>Part No.</b>	370689	<b>Ref. No.</b>	96.00275
<b>description</b>	solenoid valve 3-ways 230VAC connection 1/8" L 40mm DN 1.3mm -40 up to +180°C coil type ZH14 membranes ruby p max 20bar p min 0bar		
<b>accessories for</b>	370689		
	<b>Part No.</b>	371090	<b>Ref. No.</b> —
	power socket plug type DIN 43650A screw		

## solenoid valves (various)



1

<b>Part No.</b>	526331	<b>Ref. No.</b>	96.00474
<b>description</b>	solenoid valve 2-ways 230VAC connection 1/8" L 68mm DN 2.5mm -10 up to +70°C coil type WB4.5 membranes FKM (air/water/oil) p max 12bar p min 0bar 50-60Hz brass		
<b>For models:</b>	E9-COF, E9-Espresso, E9-LM, EtaBeta-V2-COF, EtaBeta-V2-COF-Display, EtaBeta-V2-LM, EtaBeta-V2-LM-Display, Kicco-COF, Kicco-Espresso, Kicco-LM, TemaStyle		

## pressure switches

## for coffee machines

## ø 38mm





1

<b>Part No.</b>	542179	<b>Ref. No.</b>	96.00210
<b>description</b>	pressure control ø 38mm pressure range 0.5-1.5bar 16A 250V connection 1/4" 1CO		
<b>For models:</b>	Carimalina, E9-COF, E9-Espresso, E9-LM, EtaBeta-V2-COF, EtaBeta-V2-COF-Display, EtaBeta-V2-LM, EtaBeta-V2-LM-Display, Kicco-COF, Kicco-Espresso, Kicco-LM, TemaStyle		



## electrodes

 <p>1</p>			
<b>Part No.</b>	402328	<b>Ref. No.</b>	96.00685
<b>description</b>	level electrode 1/8" total length 110mm probe L 95mm insulated probe length 65mm connection male faston 6.3mm ø 2.5mm		
<b>For models:</b>	E9-COF, E9-Espresso, E9-LM, EtaBeta-V2-COF, EtaBeta-V2-COF-Display, EtaBeta-V2-LM, EtaBeta-V2-LM-Display, Kicco-COF, Kicco-Espresso, Kicco-LM, TemaStyle		

 <p>1</p>			
<b>Part No.</b>	402329	<b>Ref. No.</b>	96.00686
<b>description</b>	level electrode 1/8" total length 125mm probe L 110mm insulated probe length 88mm connection male faston 6.3mm stainless steel ø 2.5mm		
<b>For models:</b>	E9-COF, E9-Espresso, E9-LM, EtaBeta-V2-COF, EtaBeta-V2-COF-Display, EtaBeta-V2-LM, EtaBeta-V2-LM-Display, Kicco-COF, Kicco-Espresso, Kicco-LM, TemaStyle		

## flow meters and flow sensors

### flow meters

#### GICAR

 <p>1</p>			
<b>Part No.</b>	526324	<b>Ref. No.</b>	95.01205
<b>description</b>	flow meter thread 1/4" stainless steel plug connection approval NSF flow rate 1.15l/min		
<b>For models:</b>	E9-COF, E9-Espresso, E9-LM, EtaBeta-V2-COF, EtaBeta-V2-COF-Display, EtaBeta-V2-LM, EtaBeta-V2-LM-Display, Kicco-COF, Kicco-Espresso, Kicco-LM, TemaStyle		

## motors

### gear motors

#### for automatic coffee machines

 <p>1</p>			
<b>Part No.</b>	501489	<b>Ref. No.</b>	01.01418.CL
<b>description</b>	gear motor 6-24V voltage DC shaft ø 6mm L 200mm W 60mm H 38mm		

 <p>1</p>			
<b>Part No.</b>	601987	<b>Ref. No.</b>	96.00702.CA
<b>description</b>	gear motor type EL RD-1 24V voltage DC 80rpm shaft ø 7mm L 82.4mm W 36.8mm H 36.8mm		

## electric accessories

### cables

#### connection cables

 <p>1</p>			
<b>Part No.</b>	526322	<b>Ref. No.</b>	03.00999
<b>description</b>	cable L 100mm plug type Faston 6.3mm		

## equipment-specific units

### for ice-cube maker

#### miscellaneous

 <p>1</p>			
<b>Part No.</b>	695832	<b>Ref. No.</b>	97.00102
<b>description</b>	olive for ice maker L 6.5mm ID ø 6.2mm ED ø 8.5mm		
<b>For models:</b>	E9-COF, E9-Espresso, E9-LM, EtaBeta-V2-COF, EtaBeta-V2-COF-Display, EtaBeta-V2-LM, EtaBeta-V2-LM-Display, Kicco-COF, Kicco-Espresso, Kicco-LM, TemaStyle		

### for espresso machines

#### filter holders

##### filter holders standard

##### filter holder without spout







 <p>1</p>			
<b>Part No.</b>	525989	<b>Ref. No.</b>	N/A
<b>description</b>	filter holder suitable for CARIMALI without outlet mounting ø 79.5mm outlet 3/8" ID ø 60mm wedge height 13.5mm number of wedges 3 lever straight		



## filter holders short



1

<b>Part No.</b>	529069	<b>Ref. No.</b>	22.00804.CR
<b>description</b>	filter holder mounting $\varnothing$ 79.5mm outlet 3/8" ID $\varnothing$ 60mm handle M10x1.5 wedge height 13.5mm number of wedges 3 lever straight chrome-plated brass		
<b>For models:</b>	E9-COF, E9-Espresso, E9-LM, EtaBeta-V2-COF, EtaBeta-V2-COF-Display, EtaBeta-V2-LM, EtaBeta-V2-LM-Display, Kicco-COF, Kicco-Espresso, Kicco-LM, TemaStyle		
<b>accessories for</b>	529069		
	<b>Part No.</b>	<b>Ref. No.</b>	
	525956	14.00767	
	<b>Part No.</b>	<b>Ref. No.</b>	
	526341	14.02017	
	<b>Part No.</b>	<b>Ref. No.</b>	
	526342	14.00819	
	<b>Part No.</b>	<b>Ref. No.</b>	
	529065	—	
	<b>Part No.</b>	<b>Ref. No.</b>	
	529079	—	
	<b>Part No.</b>	<b>Ref. No.</b>	
	529210	14.00768	
	<b>Part No.</b>	<b>Ref. No.</b>	
	529211	14.00769	

## handles

## with external thread



1

<b>Part No.</b>	111053	<b>Ref. No.</b>	N/A
<b>description</b>	handle $\varnothing$ 36mm thread M10x1.5 thread L 15mm L 126mm black		

## filters

## for 1 cup



1

<b>Part No.</b>	529210	<b>Ref. No.</b>	14.00768
<b>description</b>	coffee filter $\varnothing$ 68mm mounting $\varnothing$ 59.5mm H 22mm cups 1 amount of coffee 7g		
<b>For models:</b>	E9-COF, E9-Espresso, E9-LM, EtaBeta-V2-COF, EtaBeta-V2-COF-Display, EtaBeta-V2-LM, EtaBeta-V2-LM-Display, Kicco-COF, Kicco-Espresso, Kicco-LM, TemaStyle		



1

<b>Part No.</b>	526341	<b>Ref. No.</b>	14.02017
<b>description</b>	coffee filter $\varnothing$ 68mm mounting $\varnothing$ 60mm H 20mm cups 1 amount of coffee 6g		
<b>For models:</b>	E9-COF, E9-Espresso, E9-LM, EtaBeta-V2-COF, EtaBeta-V2-COF-Display, EtaBeta-V2-LM, EtaBeta-V2-LM-Display, Kicco-COF, Kicco-Espresso, Kicco-LM, TemaStyle		

## for 2 cups



1

<b>Part No.</b>	526342	<b>Ref. No.</b>	14.00819
<b>description</b>	coffee filter $\varnothing$ 68mm mounting $\varnothing$ 60mm H 21mm cups 2 amount of coffee 12g		
<b>For models:</b>	E9-COF, E9-Espresso, E9-LM, EtaBeta-V2-COF, EtaBeta-V2-LM, Kicco-COF, Kicco-Espresso, Kicco-LM, TemaStyle		



1

<b>Part No.</b>	529211	<b>Ref. No.</b>	14.00769
<b>description</b>	coffee filter $\varnothing$ 68mm mounting $\varnothing$ 60mm H 23.5mm cups 2 amount of coffee		
<b>For models:</b>	E9-COF, E9-Espresso, E9-LM, EtaBeta-V2-COF, EtaBeta-V2-COF-Display, EtaBeta-V2-LM, EtaBeta-V2-LM-Display, Kicco-COF, Kicco-Espresso, Kicco-LM, TemaStyle		

## filter holder springs



1

<b>Part No.</b>	525956	<b>Ref. No.</b>	14.00767
<b>description</b>	filter holder spring L 70mm W 60mm wire gauge $\varnothing$ 1.2mm for espresso filter holder		
<b>For models:</b>	E9-COF, E9-Espresso, E9-LM, EtaBeta-V2-COF, EtaBeta-V2-COF-Display, EtaBeta-V2-LM, EtaBeta-V2-LM-Display, Kicco-COF, Kicco-Espresso, Kicco-LM, TemaStyle		



brewing units

filter holder gaskets

flat

standard



1

<b>Part No.</b>	528044	<b>Ref. No.</b>	87.00122.00.19
<b>description</b>	filter holder gasket D1 ø 69.5mm D2 ø 57mm H 7.5mm Qty 1 pcs		
<b>For models:</b>	E9-COF, E9-Espresso, E9-LM, EtaBeta-V2-COF, EtaBeta-V2-COF-Display, EtaBeta-V2-LM, EtaBeta-V2-LM-Display, Kicco-COF, Kicco-Espresso, Kicco-LM, TemaStyle		

shim gaskets



1

<b>Part No.</b>	528068	<b>Ref. No.</b>	74.00009
<b>description</b>	shim gasket D1 ø 69mm D2 ø 57mm thickness 0.8mm paper Qty 1 pcs		
<b>For models:</b>	E9-COF, E9-Espresso, E9-LM, EtaBeta-V2-COF, EtaBeta-V2-COF-Display, EtaBeta-V2-LM, EtaBeta-V2-LM-Display, Kicco-COF, Kicco-Espresso, Kicco-LM, TemaStyle		

brewing units manual

components

miscellaneous



1

<b>Part No.</b>	528529	<b>Ref. No.</b>	93.00007
<b>description</b>	plain washer ID ø 3.5mm ED ø 6.6mm thickness 0.5mm brass Qty 1 pcs		

components

nozzles

with thread



1

<b>Part No.</b>	526338	<b>Ref. No.</b>	22.00772
<b>description</b>	nozzle bore ø 0.8mm thread 1/8" L 23mm		
<b>For models:</b>	EtaBeta-V2-COF, EtaBeta-V2-COF-Display, EtaBeta-V2-LM, EtaBeta-V2-LM-Display, Kicco-COF, Kicco-Espresso, Kicco-LM		



1

<b>Part No.</b>	529490	<b>Ref. No.</b>	22.00806
<b>description</b>	nozzle bore ø 1.2mm		
<b>For models:</b>	E9-COF, E9-Espresso, E9-LM, EtaBeta-V2-COF, EtaBeta-V2-COF-Display, EtaBeta-V2-LM, EtaBeta-V2-LM-Display, Kicco-COF, Kicco-Espresso, Kicco-LM, TemaStyle		

screws



1

<b>Part No.</b>	560373	<b>Ref. No.</b>	91.00095
<b>description</b>	cylinder head bolt thread M4 thread L 12mm WS 3 SS Qty 1 pcs intake internal hexagon DIN 912/ISO 4762		
<b>For models:</b>	E9-COF, E9-Espresso, E9-LM, EtaBeta-V2-COF, EtaBeta-V2-COF-Display, EtaBeta-V2-LM, EtaBeta-V2-LM-Display, Kicco-COF, Kicco-Espresso, Kicco-LM, TemaStyle		

miscellaneous



1

<b>Part No.</b>	530477	<b>Ref. No.</b>	37.00533
<b>description</b>	tap aerator		

water dispersions

water dispersions

group 3

1

<b>Part No.</b>	529495	<b>Ref. No.</b>	22.00896.NP	
<b>description</b>	water distributor ø 57.6mm H 14mm 8 holes hole ø 1.5mm thread M5 mounting ø 5.5mm bore ø 13mm stainless steel			
<b>accessories for</b>	529495			
	<b>Part No.</b>	529084	<b>Ref. No.</b>	—
	 shower screen ø 52mm hole ø 6.4mm			





			
1			
<b>Part No.</b>	526328	<b>Ref. No.</b>	22.01225.NP
<b>description</b>	water distributor ø 57.7mm H 14mm 8 holes hole ø 1.5mm mounting ø 5.2mm stainless steel		
<b>For models:</b>	E9-COF, E9-Espresso, E9-LM, EtaBeta-V2-COF, EtaBeta-V2-COF-Display, EtaBeta-V2-LM, EtaBeta-V2-LM-Display, Kicco-COF, Kicco-Espresso, Kicco-LM, TemaStyle		

<b>accessories</b>			
			
1			
<b>Part No.</b>	529494	<b>Ref. No.</b>	87.00111 87.00111.00.19
<b>description</b>	gasket water dispersion		
<b>For models:</b>	E9-COF, E9-Espresso, E9-LM, EtaBeta-V2-COF, EtaBeta-V2-COF-Display, EtaBeta-V2-LM, EtaBeta-V2-LM-Display, Kicco-COF, Kicco-Espresso, Kicco-LM, TemaStyle		

<b>safety valves</b>			
<b>safety valves</b>			
3/8"			
			
1			
<b>Part No.</b>	526330	<b>Ref. No.</b>	95.00980 97.00148
<b>description</b>	safety valve connection 3/8" triggering pressure 1.9bar		
<b>For models:</b>	E9-COF, E9-Espresso, E9-LM, EtaBeta-V2-COF, EtaBeta-V2-COF-Display, EtaBeta-V2-LM, EtaBeta-V2-LM-Display, Kicco-COF, Kicco-Espresso, Kicco-LM, TemaStyle		

<b>metric thread</b>			
			
1			
<b>Part No.</b>	529308	<b>Ref. No.</b>	N/A
<b>description</b>	safety valve connection M19x1 triggering pressure 1.8bar		

<b>expansion valves</b>			
<b>with hose connection</b>			
			
1			
<b>Part No.</b>	530481	<b>Ref. No.</b>	97.00125
<b>description</b>	expansion valve 2-way T1: 1/4" ET hose ø 8mm triggering pressure 13bar BL 45mm total length 70mm		

<b>with non-return valve</b>			
			
1			
<b>Part No.</b>	526340	<b>Ref. No.</b>	01.00473
<b>description</b>	expansion valve with non-return valve		
<b>For models:</b>	E9-COF, E9-Espresso, E9-LM, EtaBeta-V2-COF, EtaBeta-V2-COF-Display, EtaBeta-V2-LM, EtaBeta-V2-LM-Display, Kicco-COF, Kicco-Espresso, Kicco-LM, TemaStyle		

<b>drain pans</b>			
<b>drain pans</b>			
			
1			
<b>Part No.</b>	526323	<b>Ref. No.</b>	37.00659
<b>description</b>	drain pan L 177mm W 98mm H 55 PT100 probemmm hose ø 1/2"mm		
<b>For models:</b>	E9-COF, E9-Espresso, E9-LM, EtaBeta-V2-COF, EtaBeta-V2-COF-Display, EtaBeta-V2-LM, EtaBeta-V2-LM-Display, Kicco-COF, Kicco-Espresso, Kicco-LM, TemaStyle		

<b>hose couplings</b>			
			
1			
<b>Part No.</b>	526329	<b>Ref. No.</b>	22.00805
<b>description</b>	hose connector connection 18mm thread 1/2" brass		
<b>For models:</b>	E9-COF, E9-Espresso, E9-LM, EtaBeta-V2-COF, EtaBeta-V2-COF-Display, EtaBeta-V2-LM, EtaBeta-V2-LM-Display, Kicco-COF, Kicco-Espresso, Kicco-LM, TemaStyle		





aerators and air bleeders



<b>Part No.</b>	529863	<b>Ref. No.</b>	01.00440
<b>description</b>	aerator and air bleeder		
<b>For models:</b>	E9-COF, E9-Espresso, E9-LM, EtaBeta-V2-COF, EtaBeta-V2-COF-Display, EtaBeta-V2-LM, EtaBeta-V2-LM-Display, Kicco-COF, Kicco-Espresso, Kicco-LM, TemaStyle		



<b>Part No.</b>	529303	<b>Ref. No.</b>	01.00504
<b>description</b>	aerator and air bleeder connection 1/4" only steam		
<b>For models:</b>	E9-COF, E9-Espresso, E9-LM, EtaBeta-V2-COF, EtaBeta-V2-COF-Display, EtaBeta-V2-LM, EtaBeta-V2-LM-Display, Kicco-COF, Kicco-Espresso, Kicco-LM, TemaStyle		

spare parts for 529303



<b>Part No.</b>	528687	<b>Ref. No.</b>	—
O-ring Viton thickness 1.78mm ID ø 3.69mm Qty 1 pcs			

steam/water taps

steam/water taps

steam taps

steam taps (complete)



<b>Part No.</b>	529640	<b>Ref. No.</b>	01.00489
<b>description</b>	steam tap with breathers inlet 3/8" outlet 3/8"		
<b>For models:</b>	E9-COF, E9-Espresso, E9-LM, EtaBeta-V2-COF, EtaBeta-V2-COF-Display, EtaBeta-V2-LM, EtaBeta-V2-LM-Display, Kicco-COF, Kicco-Espresso, Kicco-LM, TemaStyle		

knobs



<b>Part No.</b>	526335	<b>Ref. No.</b>	01.01894
<b>description</b>	knob black		
<b>For models:</b>	E9-COF, E9-Espresso, E9-LM, EtaBeta-V2-COF, EtaBeta-V2-COF-Display, EtaBeta-V2-LM, EtaBeta-V2-LM-Display, Kicco-COF, Kicco-Espresso, Kicco-LM, TemaStyle		

components

bushes



<b>Part No.</b>	525566	<b>Ref. No.</b>	22.00929
<b>description</b>	bush D1 ø 15mm D2 ø 12mm ID ø 7mm H 10mm brass		
<b>For models:</b>	E9-COF, E9-Espresso, E9-LM, EtaBeta-V2-COF, EtaBeta-V2-COF-Display, EtaBeta-V2-LM, EtaBeta-V2-LM-Display, Kicco-COF, Kicco-Espresso, Kicco-LM, TemaStyle		

gaskets



<b>Part No.</b>	529474	<b>Ref. No.</b>	N/A
<b>description</b>	gasket D1 ø 14mm D2 ø 4mm thickness 5mm coffee machine		

water taps

knobs



<b>Part No.</b>	526335	<b>Ref. No.</b>	01.01894
<b>description</b>	knob black		
<b>For models:</b>	E9-COF, E9-Espresso, E9-LM, EtaBeta-V2-COF, EtaBeta-V2-COF-Display, EtaBeta-V2-LM, EtaBeta-V2-LM-Display, Kicco-COF, Kicco-Espresso, Kicco-LM, TemaStyle		

water taps



<b>Part No.</b>	529641	<b>Ref. No.</b>	01.00490
<b>description</b>	water tap inlet 3/8" outlet 3/8"		
<b>For models:</b>	E9-COF, E9-Espresso, E9-LM, EtaBeta-V2-COF-Display, EtaBeta-V2-LM-Display, Kicco-COF, Kicco-Espresso, Kicco-LM, TemaStyle		

steam/water pipes

steam pipes



<b>Part No.</b>	526327	<b>Ref. No.</b>	02.00302.CR
<b>description</b>	steam pipe H 205mm tube ø 8mm		
<b>For models:</b>	E9-Espresso, Kicco-Espresso		



			
1			
<b>Part No.</b>	526326	<b>Ref. No.</b>	02.01459.CR
<b>description</b>	steam pipe H 230mm tube ø 8mm		
<b>For models:</b>	E9-COF, E9-Espresso, E9-LM, EtaBeta-V2-COF, EtaBeta-V2-COF-Display, EtaBeta-V2-LM, EtaBeta-V2-LM-Display, Kicco-COF, Kicco-LM		

## nozzles for steam pipes

			
1			
<b>Part No.</b>	529673	<b>Ref. No.</b>	22.00189
<b>description</b>	steam nozzle thread M10x1 ø 12mm L 16mm 4 holes bore ø 1.25mm chrome-plated brass		
<b>For models:</b>	E9-Espresso, Kicco-Espresso, TemaStyle		

## nozzles for water pipes

## tap aerators

			
1			
<b>Part No.</b>	529608	<b>Ref. No.</b>	95.00746
<b>description</b>	tap aerator D1 ø 23mm H 15mm thread M22x1		
<b>For models:</b>	E9-COF, E9-Espresso, E9-LM, EtaBeta-V2-COF, EtaBeta-V2-COF-Display, EtaBeta-V2-LM, EtaBeta-V2-LM-Display, Kicco-COF, Kicco-Espresso, Kicco-LM, TemaStyle		

## accessories

## springs

			
1			
<b>Part No.</b>	529704	<b>Ref. No.</b>	13.00059
<b>description</b>	compression spring ø 11.8mm L 16mm wire gauge ø 1.6mm steel		

## tube handles

			
1			
<b>Part No.</b>	529627	<b>Ref. No.</b>	37.00225
<b>description</b>	tube handle ø 8mm L 30mm plastic		
<b>For models:</b>	E9-COF, E9-Espresso, E9-LM, EtaBeta-V2-COF, EtaBeta-V2-COF-Display, EtaBeta-V2-LM, EtaBeta-V2-LM-Display, Kicco-COF, Kicco-Espresso, Kicco-LM, TemaStyle		

## union nuts

			
1			
<b>Part No.</b>	526334	<b>Ref. No.</b>	22.01186.CR
<b>description</b>	nut thread 3/8" L 21mm hole ø 13mm chrome-plated		
<b>For models:</b>	E9-COF, E9-Espresso, E9-LM, EtaBeta-V2-COF, EtaBeta-V2-COF-Display, EtaBeta-V2-LM, EtaBeta-V2-LM-Display, Kicco-COF, Kicco-Espresso, Kicco-LM, TemaStyle		

## non-return valves

## complete

			
1			
<b>Part No.</b>	527978	<b>Ref. No.</b>	95.01280
<b>description</b>	non-return valve inlet 3/8" outlet 3/8" L 38mm		
<b>For models:</b>	E9-COF, E9-Espresso, E9-LM, EtaBeta-V2-COF, EtaBeta-V2-COF-Display, EtaBeta-V2-LM, EtaBeta-V2-LM-Display, Kicco-COF, Kicco-Espresso, Kicco-LM, TemaStyle		

## miscellaneous

			
1			
<b>Part No.</b>	111106	<b>Ref. No.</b>	22.00751
<b>description</b>	mixer coupling		
<b>For models:</b>	E9-COF, E9-Espresso, E9-LM, EtaBeta-V2-COF, EtaBeta-V2-COF-Display, EtaBeta-V2-LM, EtaBeta-V2-LM-Display, Kicco-COF, Kicco-Espresso, Kicco-LM, TemaStyle		

			
1			
<b>Part No.</b>	530483	<b>Ref. No.</b>	01.01412
<b>description</b>	pressure reduction valve thread M5 ø 10mm L 42mm hose ø 5mm stainless steel		

## screw connections

## hose connectors

			
1			
<b>Part No.</b>	530484	<b>Ref. No.</b>	97.00070.00.19
<b>description</b>	hose connector thread M5 L 19mm hose ø 4mm stainless steel		

## for coffee grinders

## grinding burrs

## grinding burrs straight

## standard

			
1			
<b>Part No.</b>	525533	<b>Ref. No.</b>	95.00404
<b>description</b>	grinding burrs pair turn direction left D1 ø 64mm ID ø 37mm H 9mm tooth spacing 3mm hole ø 5.6mm bore ø 8.5mm mounting ø 50		



for cup coffee machines

instant mixer units



1			
<b>Part No.</b>	530487	<b>Ref. No.</b>	95.01760
<b>description</b>	flange for mixing hopper ø 63mm plastic		

coffee spouts

coffee spouts



1			
<b>Part No.</b>	530488	<b>Ref. No.</b>	37.00286
<b>description</b>	coffee spout 2-way		

pistons

components



1			
<b>Part No.</b>	530486	<b>Ref. No.</b>	37.00779
<b>description</b>	piston ø 45mm H 23mm hole ø 8mm plastic		

grinding units

grinding units



1			01.05007
<b>Part No.</b>	531211	<b>Ref. No.</b>	0105608+0305031+3305033+9505035+96
<b>description</b>	grinding unit complete for CARIMALI		

mechanical components



1			
<b>Part No.</b>	698548	<b>Ref. No.</b>	86.05000
<b>description</b>	adapter ext. ø 53 ID ø 51mm H 10.5mm		



1			
<b>Part No.</b>	698660	<b>Ref. No.</b>	37.00531
<b>description</b>	duct plastic ext. ø 18mm hose ø 7mm L 44mm		



1			
<b>Part No.</b>	698547	<b>Ref. No.</b>	01.01704
<b>description</b>	ejector H 32mm W 50mm L 108mm		

miscellaneous



1			
<b>Part No.</b>	696661	<b>Ref. No.</b>	97.00097
<b>description</b>	bush L 15mm brass ID ø 3mm D1 ø 5mm D2 ø 4mm		
<b>For models:</b>	E9-COF, E9-Espresso, E9-LM, EtaBeta-V2-COF, EtaBeta-V2-COF-Display, EtaBeta-V2-LM, EtaBeta-V2-LM-Display, Kicco-COF, Kicco-Espresso, Kicco-LM, TemaStyle		



1			
<b>Part No.</b>	530485	<b>Ref. No.</b>	37.00803
<b>description</b>	cap L 47mm plastic W 37.5mm		



1			
<b>Part No.</b>	650226	<b>Ref. No.</b>	37.00852
<b>description</b>	drip tray plastic H 60mm W 335mm D 310mm		



1

<b>Part No.</b>	695832	<b>Ref. No.</b>	97.00102
<b>description</b>	olive for ice maker L 6.5mm ID $\varnothing$ 6.2mm ED $\varnothing$ 8.5mm		
<b>For models:</b>	E9-COF, E9-Espresso, E9-LM, EtaBeta-V2-COF, EtaBeta-V2-COF-Display, EtaBeta-V2-LM, EtaBeta-V2-LM-Display, Kicco-COF, Kicco-Espresso, Kicco-LM, TemaStyle		

## knobs

### steam/water taps

### steam/water taps



1

<b>Part No.</b>	526335	<b>Ref. No.</b>	01.01894
<b>description</b>	knob black		
<b>For models:</b>	E9-COF, E9-Espresso, E9-LM, EtaBeta-V2-COF, EtaBeta-V2-COF-Display, EtaBeta-V2-LM, EtaBeta-V2-LM-Display, Kicco-COF, Kicco-Espresso, Kicco-LM, TemaStyle		

### knob dial plates



1

<b>Part No.</b>	526318	<b>Ref. No.</b>	33.00266
<b>description</b>	knob dial plate steam		
<b>For models:</b>	E9-COF, E9-Espresso, E9-LM, EtaBeta-V2-COF, EtaBeta-V2-COF-Display, EtaBeta-V2-LM, EtaBeta-V2-LM-Display, Kicco-COF, Kicco-Espresso, Kicco-LM, TemaStyle		



1

<b>Part No.</b>	526319	<b>Ref. No.</b>	33.00296
<b>description</b>	knob dial plate water		
<b>For models:</b>	E9-COF, E9-Espresso, E9-LM, EtaBeta-V2-COF-Display, EtaBeta-V2-LM-Display, Kicco-COF, Kicco-Espresso, Kicco-LM, TemaStyle		

## handles and hand wheels

### lever handles



1

<b>Part No.</b>	526325	<b>Ref. No.</b>	37.00694
<b>description</b>	lever handle $\varnothing$ 48mm shaft $\varnothing$ 6mm		
<b>For models:</b>	E9-COF, E9-Espresso, E9-LM, EtaBeta-V2-COF, EtaBeta-V2-COF-Display, EtaBeta-V2-LM, EtaBeta-V2-LM-Display, Kicco-COF, Kicco-Espresso, Kicco-LM, TemaStyle		

## gaskets

### refrigeration gaskets

### screw-in gaskets

### profile 9140

We offer custom-made gaskets for this profile

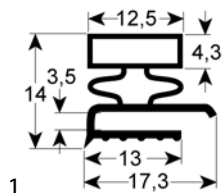

1

<b>Part No.</b>	901873	<b>Ref. No.</b>	95.01797
<b>description</b>	refrigeration gasket profile 9140 W 180mm L 295mm external size		

## O-rings

### EPDM



1

<b>Part No.</b>	510302	<b>Ref. No.</b>	87.00032
<b>description</b>	O-ring EPDM ID $\varnothing$ 12.42mm thickness 1.78mm Qty 1 pcs		
<b>For models:</b>	E9-COF, E9-Espresso, E9-LM, EtaBeta-V2-COF, EtaBeta-V2-COF-Display, EtaBeta-V2-LM, EtaBeta-V2-LM-Display, Kicco-COF, Kicco-Espresso, Kicco-LM, TemaStyle		

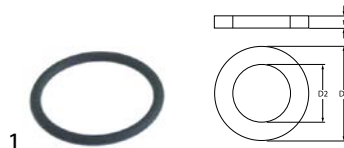

1

<b>Part No.</b>	540682	<b>Ref. No.</b>	87.00141
<b>description</b>	O-ring EPDM thickness 1.78mm ID $\varnothing$ 18.77mm Qty 1 pcs		
<b>For models:</b>	E9-COF, E9-Espresso, E9-LM, EtaBeta-V2-COF, EtaBeta-V2-COF-Display, EtaBeta-V2-LM, EtaBeta-V2-LM-Display, Kicco-COF, Kicco-Espresso, Kicco-LM, TemaStyle		

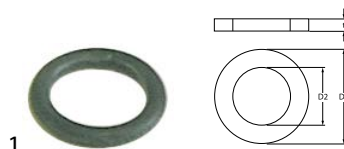

1

<b>Part No.</b>	528223	<b>Ref. No.</b>	87.00006.00.19
<b>description</b>	O-ring EPDM thickness 2.62mm ID $\varnothing$ 11.91mm Qty 1 pcs		
<b>For models:</b>	E9-COF, E9-Espresso, E9-LM, EtaBeta-V2-COF, EtaBeta-V2-COF-Display, EtaBeta-V2-LM, EtaBeta-V2-LM-Display, Kicco-COF, Kicco-Espresso, Kicco-LM, TemaStyle		



1

<b>Part No.</b>	507313	<b>Ref. No.</b>	87.00019
<b>description</b>	O-ring EPDM thickness 2.62mm ID ø 13.95mm Qty 1 pcs		

**silicone**

1

<b>Part No.</b>	532602	<b>Ref. No.</b>	87.00142
<b>description</b>	O-ring silicone thickness 3.53mm ID ø 36.1mm Qty 1 pcs		

**Viton**

1

<b>Part No.</b>	521077	<b>Ref. No.</b>	87.05003.00.19
<b>description</b>	O-ring Viton thickness 5.34mm ID ø 37.47mm Qty 1 pcs		

**sealing washers**

**fibre gaskets**

1

<b>Part No.</b>	528017	<b>Ref. No.</b>	N/A
<b>description</b>	flat gasket fibre ED ø 53mm ID ø 42mm thickness 2mm for thread 1¼" Qty 1 pcs		

**copper gaskets**

**DIN-7603-A**

1

<b>Part No.</b>	529480	<b>Ref. No.</b>	95.01166
<b>description</b>	flat gasket copper ED ø 18mm ID ø 14mm thickness 1.5mm		
<b>For models:</b>	E9-COF, E9-Espresso, E9-LM, EtaBeta-V2-COF, EtaBeta-V2-COF-Display, EtaBeta-V2-LM, EtaBeta-V2-LM-Display, Kicco-COF, Kicco-Espresso, Kicco-LM, TemaStyle		

**PTFE gaskets**

1

<b>Part No.</b>	528052	<b>Ref. No.</b>	88.00045
<b>description</b>	flat gasket PTFE ED ø 50mm ID ø 40mm thickness 3mm Qty 1 pcs		
<b>For models:</b>	E9-COF, E9-Espresso, E9-LM, EtaBeta-V2-COF, EtaBeta-V2-COF-Display, EtaBeta-V2-LM, EtaBeta-V2-LM-Display, Kicco-COF, Kicco-Espresso, Kicco-LM, TemaStyle		

1

<b>Part No.</b>	528022	<b>Ref. No.</b>	N/A
<b>description</b>	flat gasket PTFE ED ø 52mm ID ø 41mm thickness 2mm size 1¼" Qty 1 pcs suitable for CARIMALI, FAEMA, MARZOCCO, PAVONI		

1

<b>Part No.</b>	526332	<b>Ref. No.</b>	88.00015.00.19
<b>description</b>	gasket PTFE ED ø 25mm ID ø 17.5mm thickness 1.5mm Qty 1 pcs suitable for CARIMALI		
<b>For models:</b>	E9-COF, E9-Espresso, E9-LM, EtaBeta-V2-COF, EtaBeta-V2-COF-Display, EtaBeta-V2-LM, EtaBeta-V2-LM-Display, Kicco-COF, Kicco-Espresso, Kicco-LM, TemaStyle		

**springs**

**compression springs**

1

<b>Part No.</b>	529722	<b>Ref. No.</b>	13.00059
<b>description</b>	compression spring ø 11.6mm L 31mm wire gauge ø 1.4mm		
<b>For models:</b>	E9-COF, E9-Espresso, E9-LM, EtaBeta-V2-COF, EtaBeta-V2-COF-Display, EtaBeta-V2-LM, EtaBeta-V2-LM-Display, Kicco-COF, Kicco-Espresso, Kicco-LM, TemaStyle		

1

<b>Part No.</b>	529704	<b>Ref. No.</b>	13.00059
<b>description</b>	compression spring ø 11.8mm L 16mm wire gauge ø 1.6mm steel		

1

<b>Part No.</b>	696748	<b>Ref. No.</b>	C0008CPS056
<b>description</b>	spring ø 19mm L 43mm wire gauge ø 2mm windings 10 steel		





## coffee accessories

### milk foamers

#### milk foamers



1

<b>Part No.</b>	802100	<b>Ref. No.</b>	01.01207
<b>description</b>	milk foamer connection 6mm angle 60° plastic		
<b>For models:</b>	E9-COF, E9-Espresso, E9-LM, EtaBeta-V2-COF, EtaBeta-V2-COF-Display, EtaBeta-V2-LM, EtaBeta-V2-LM-Display, Kicco-COF, Kicco-Espresso, Kicco-LM, TemaStyle		



1

<b>Part No.</b>	525933	<b>Ref. No.</b>	04.00405	
<b>description</b>	milk foamer connection 6mm angle 90° plastic			
<b>accessories for</b>	525933			
	<b>Part No.</b>	531255	<b>Ref. No.</b>	—
	adapter thread 3/8" L 40mm			

## manometers



1

<b>Part No.</b>	541226	<b>Ref. No.</b>	95.01545
<b>description</b>	manometer double scale ø 60mm pressure range 0-2.5 / 0-16bar connection on the backside thread 1/8"		
<b>For models:</b>	E9-COF, E9-Espresso, E9-LM, EtaBeta-V2-COF, EtaBeta-V2-COF-Display, EtaBeta-V2-LM, EtaBeta-V2-LM-Display, Kicco-COF, Kicco-Espresso, Kicco-LM, TemaStyle		



1

<b>Part No.</b>	541228	<b>Ref. No.</b>	N/A
<b>description</b>	manometer ø 41mm pressure range 0 up to 15bar thread 1/8" marking 7-8 connection on the backside		



1

<b>Part No.</b>	541206	<b>Ref. No.</b>	N/A
<b>description</b>	manometer ø 42mm pressure range 0 up to 16bar thread 1/8" marking 12 connection on the backside		



1

<b>Part No.</b>	541229	<b>Ref. No.</b>	N/A
<b>description</b>	manometer ø 44mm pressure range 0 up to 3bar thread 1/8" marking 2 connection on the backside		



1

<b>Part No.</b>	541230	<b>Ref. No.</b>	N/A
<b>description</b>	manometer ø 53mm pressure range 0 up to 2bar connection on the backside marking 1.4-2.0 thread 1/8"		

## hoses

### industrial hoses

#### silicone hoses

#### without fabric



1

<b>Part No.</b>	570156	<b>Ref. No.</b>	84.00028
<b>description</b>	silicone hose ID ø 3mm ED ø 7mm thickness 2mm t.max. 200°C brown		



## fittings, hose and pipe connectors

### hose connectors

#### without screw connection



1

<b>Part No.</b>	501488	<b>Ref. No.</b>	97.00111 97.05036
<b>description</b>	Y-piece plastic hose ø 5-5-5mm 3-way		

## fastening material

### screws

#### countersunk screws



1

<b>Part No.</b>	560216	<b>Ref. No.</b>	91.00207
<b>description</b>	countersunk screw thread M5 L 20mm SS DIN 963/ISO 2009 Qty 20 pcs intake slotted head ø 9.2mm		
<b>For models:</b>	E9-COF, E9-Espresso, E9-LM, EtaBeta-V2-COF, EtaBeta-V2-COF-Display, EtaBeta-V2-LM, EtaBeta-V2-LM-Display, Kicco-COF, Kicco-Espresso, Kicco-LM, TemaStyle		

#### cylinder head bolts

##### DIN 912/ISO 4762



1

<b>Part No.</b>	560373	<b>Ref. No.</b>	91.00095
<b>description</b>	cylinder head bolt thread M4 thread L 12mm WS 3 SS Qty 1 pcs intake internal hexagon DIN 912/ISO 4762		
<b>For models:</b>	E9-COF, E9-Espresso, E9-LM, EtaBeta-V2-COF, EtaBeta-V2-COF-Display, EtaBeta-V2-LM, EtaBeta-V2-LM-Display, Kicco-COF, Kicco-Espresso, Kicco-LM, TemaStyle		

#### grub screws

##### DIN 914/ISO 4027



1

<b>Part No.</b>	697417	<b>Ref. No.</b>	91.00056
<b>description</b>	grub screw thread M5 L 10mm stainless steel DIN 914/ISO 4027 WS 2.5 with spike Qty 1 pcs		
<b>For models:</b>	E9-COF, E9-Espresso, E9-LM, EtaBeta-V2-COF, EtaBeta-V2-COF-Display, EtaBeta-V2-LM, EtaBeta-V2-LM-Display, Kicco-COF, Kicco-Espresso, Kicco-LM, TemaStyle		

### nuts

#### hexagonal nuts

##### DIN 934 / ISO 4032/8673



1

<b>Part No.</b>	560129	<b>Ref. No.</b>	92.00008
<b>description</b>	hexagonal nut thread M5 H 4mm WS 8 SS DIN/ISO DIN 934 / ISO 4032/8673 Qty 1 pcs		
<b>For models:</b>	E9-COF, E9-Espresso, E9-LM, EtaBeta-V2-COF, EtaBeta-V2-COF-Display, EtaBeta-V2-LM, EtaBeta-V2-LM-Display, Kicco-COF, Kicco-Espresso, Kicco-LM, TemaStyle		

#### hexagonal nuts metric (without norm)



1

<b>Part No.</b>	527169	<b>Ref. No.</b>	92.00005
<b>description</b>	hexagonal nut thread M3 H 2.8mm WS 5.5 brass Qty 1 pcs		

### washers

#### spring washers

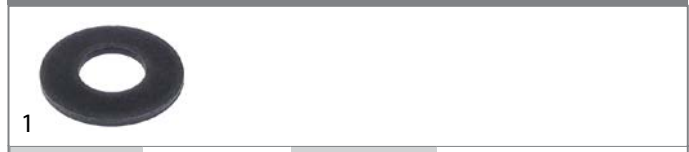

1

<b>Part No.</b>	531147	<b>Ref. No.</b>	13.00058
<b>description</b>	spring washer ID ø 6.3mm ED ø 18mm thickness 0.8mm Qty 1 pcs		

#### washers

##### miscellaneous

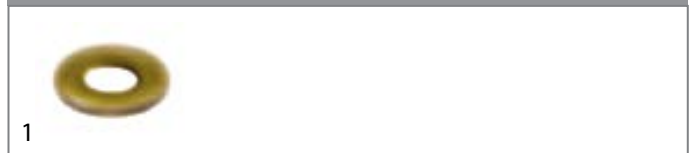

1

<b>Part No.</b>	528529	<b>Ref. No.</b>	93.00007
<b>description</b>	plain washer ID ø 3.5mm ED ø 6.6mm thickness 0.5mm brass Qty 1 pcs		



## fasteners

## retaining rings

## DIN 6799



<b>Part No.</b>	529724	<b>Ref. No.</b>	94.00040
<b>description</b>	retaining ring E D1 ø 4mm D2 ø 9mm SS DIN 6799 thickness 0.7mm for shaft ø 4-5mm		
<b>For models:</b>	E9-COF, E9-Espresso, E9-LM, EtaBeta-V2-COF, EtaBeta-V2-COF-Display, EtaBeta-V2-LM, EtaBeta-V2-LM-Display, Kicco-COF, Kicco-Espresso, Kicco-LM, TemaStyle		

**GASTRO**PARTS.COM

