



GASTROPARTS

Brugnetti

- [EN]** Equipment
- [DE]** Geräte
- [ES]** Aparatos
- [FR]** Équipement
- [IT]** Attrezzature
- [PL]** Urządzenia
- [RU]** Оборудование

✉ gastroparts@gastroparts.com

☎ +48 56 657 00 66

📘 fb.com/gastroparts.global

GASTROPARTS.COM







heating elements

heating elements for coffee machine

			
1			
Part No.	417262	Ref. No.	000644.F
description	heating element 2000W 230/400V heating circuits 3 mounting ø 39mm hole distance 58mm L 178mm W 33mm H 33mm hole ø 10mm length thermostat sleeves 140mm thermostat sleeves ø 5mm number of thermostat sleeves 1 thermostat sleeve eccentric, non clinging tube ø 8mm connection 2.5 210 3 hole flange		

			
1			
Part No.	417263	Ref. No.	000645.F
description	heating element 3000W 230/400V heating circuits 3 mounting ø 39mm hole distance 58mm L 305mm W 33mm H 33mm hole ø 10mm length thermostat sleeves 148mm thermostat sleeves ø 5mm number of thermostat sleeves 1 thermostat sleeve eccentric, non clinging tube ø 8mm connection M3 immersion heater 3 hole flange		

			
1			
Part No.	417264	Ref. No.	000646.F
description	heating element 6000W 230/400V heating circuits 3 mounting ø 39mm hole distance 58mm L 520mm W 33mm H 33mm hole ø 10mm length thermostat sleeves 146mm thermostat sleeves ø 5mm number of thermostat sleeves 1 thermostat sleeve eccentric, non clinging tube ø 8mm connection M3 immersion heater 3 hole flange		

accessories

hexagonal nuts

			
1			
Part No.	361184	Ref. No.	521381
description	nut thread 1/2" H 6mm nickel-plated brass WS 24 Qty 1 pcs		

flange gaskets

			
1			
Part No.	528740	Ref. No.	000308.F
description	gasket ID ø 44mm PTFE thickness 3.5mm hole ø 9.5mm hole distance 58mm suitable for ITALCREM, VISACREM for heating element coffee machine parts		

thermostats

bi-metal thermostats

safety bi-metal thermostats

			
1			
Part No.	390852	Ref. No.	05.1700.10.20
description	bi-metal safety thermostat hole distance 39-44mm switch-off temp. 135°C 2NC 2-pole 16A connection F6.3		

			
1			
Part No.	390688	Ref. No.	05.1700.10.20 old
description	bi-metal safety thermostat hole distance 39mm switch-off temp. 130°C 2NC 2-pole 10A connection male faston 3.2mm mounting ø 31mm		

electronics

PCBs

			
1			
Part No.	402248	Ref. No.	550.9.5.13.41
description	display coffee machine L 80mm W 36mm		

central units

			
1			
Part No.	402250	Ref. No.	550.9.5.25.32
description	central unit 3 groups for coffee machine 230V 50/60Hz type 3d5 MAESTRO 3GRCTD voltage AC		



dosing electronics

GICAR



1

Part No.	402247	Ref. No.	88.1.13.01
description	dosing electronics with level controller 250V voltage AC 50/60Hz 3/3/3/8A type ET30 Plus EM 2GRC		

keypads

keypad units



1

Part No.	402702	Ref. No.	88 1.22.02
description	keypad unit buttons 5 lighting LED		



1

Part No.	402251	Ref. No.	550.9.9.08.55
description	keypad unit buttons 6 L 113mm W 35.5mm with LED		

solenoid valves

Solenoid valve - accessories



1

Part No.	525765	Ref. No.	000187
description	mounting plate for solenoid valve		



1

Part No.	528952	Ref. No.	000187old
description	mounting plate for solenoid valve		

accessories for 528952



Part No.	528954	Ref. No.	—
description	nozzle hole \varnothing 0.8mm thread M6 thread L 6mm brass		

electrodes



1

Part No.	401157	Ref. No.	000436
description	level electrode 1/4" total length 150mm probe L 122mm insulated probe length 26mm connection male faston 6.3mm stainless steel \varnothing 2.5mm		

equipment-specific units

for espresso machines

filter holders

filter holders standard

filter holders short



1

Part No.	525776	Ref. No.	000047 000047.57
description	filter holder mounting \varnothing 82.8mm outlet 3/8" ID \varnothing 61.5mm handle M12x1.75 wedge height 9.7mm wedge position horizontal number of wedges 2 lever inclined chrome-plated brass		

filters

for 1 cup



1

Part No.	527631	Ref. No.	N/A
description	coffee filter \varnothing 70mm mounting \varnothing 60.7mm H 17mm cups 1 amount of coffee 8g		

brewing units

shower screens

with upstand and central hole

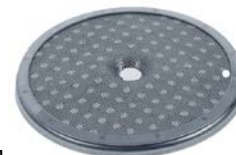

1

Part No.	525772	Ref. No.	000182
description	shower screen \varnothing 56.5mm H 6.3mm hole \varnothing 5.6mm		





			
1			
Part No.	529031	Ref. No.	000182
description	shower screen ø 56.7mm H 6.1mm hole ø 5.5mm		

filter holder gaskets			
flat			
standard			
			
1			
Part No.	525775	Ref. No.	000177
description	filter holder gasket D1 ø 72mm D2 ø 56.5mm H 8.8mm with outside notch Qty 1 pcs		

brewing units with solenoid valve			
pipes			
			
1			
Part No.	526079	Ref. No.	800643
description	drain pipe for solenoid valve ø 6mm L 255mm copper		

			
1			
Part No.	526081	Ref. No.	800637
description	injection pipe ø 6mm ID ø 4mm L 200mm T1: 1/8"		



components			
nozzles			
bushes			
			
1			
Part No.	528321	Ref. No.	000178
description	filter support D1 ø 13mm ID ø 5mm int. ø 1 11mm H 9mm brass		

with thread			
			
1			
Part No.	528486	Ref. No.	000184
description	nozzle bore ø 0.7mm thread M6x0.75 L 9mm WS 7		

water dispersions			
water dispersions			
group 2			
			
1			
Part No.	525767	Ref. No.	000183
description	water distributor ø 30mm H 13mm ET M10x1 IT M5 grooves 6 2.5mm brass		

safety valves			
gaskets			
			
1			
Part No.	526078	Ref. No.	000360
description	gasket D1 ø 15mm thickness 4mm Viton for safety valve		

springs			
			
1			
Part No.	526077	Ref. No.	000361
description	compression spring ø 7mm L 26mm wire gauge ø 0.8mm for safety valve		

steam/water taps			
steam/water taps			
steam/water taps			
			
1			
Part No.	526074	Ref. No.	407.800515
description	steam/water tap inlet 1/4" outlet 3/8" brass		
accessories for	526074		
	Part No.	111318	Ref. No.
			—
	Part No.	361184	Ref. No.
			521381
	nut thread 1/2" H 6mm nickel-plated brass WS 24 Qty 1 pcs		



steam taps

miscellaneous



Part No.	111279	Ref. No.	B-MC-0058
-----------------	--------	-----------------	-----------

description	knob spring \varnothing 29mm L 5mm wire gauge \varnothing 1.1mm
--------------------	---

components

shafts



Part No.	526076	Ref. No.	521105
-----------------	--------	-----------------	--------

description	shaft for steam-/water-tap \varnothing 14.75mm L 88mm brass
--------------------	---

bushes



Part No.	526010	Ref. No.	521013
-----------------	--------	-----------------	--------

description	bush steam/water tap D1 \varnothing 10.5mm D2 \varnothing 9mm ID \varnothing 6.3mm H 4.6mm brass
--------------------	--

accessories for	526010
------------------------	--------



Part No.	526005	Ref. No.	—
-----------------	--------	-----------------	---

description	shaft steam tap \varnothing 14.8mm L 92.5mm thread M6 brass
--------------------	---



Part No.	526023	Ref. No.	521112
-----------------	--------	-----------------	--------

description	bush steam/water tap D1 \varnothing 12mm D2 \varnothing 8.5mm ID \varnothing 7mm H 6mm brass
--------------------	--

gaskets



Part No.	527970	Ref. No.	000049
-----------------	--------	-----------------	--------

description	flat gasket PTFE ED \varnothing 24mm ID \varnothing 18mm thickness 2mm Qty 1 pcs
--------------------	--



Part No.	526080	Ref. No.	521106
-----------------	--------	-----------------	--------

description	gasket D1 \varnothing 12.5mm thickness 6.6mm silicone with notch
--------------------	--



Part No.	525774	Ref. No.	000213
-----------------	--------	-----------------	--------

description	gasket D1 \varnothing 16mm ID \varnothing 4mm thickness 4mm
--------------------	---

springs



Part No.	111279	Ref. No.	B-MC-0058
-----------------	--------	-----------------	-----------

description	knob spring \varnothing 29mm L 5mm wire gauge \varnothing 1.1mm
--------------------	---



Part No.	526024	Ref. No.	521014
-----------------	--------	-----------------	--------

description	spring \varnothing 10.3mm L 31mm wire gauge \varnothing 1.2mm
--------------------	---



Part No.	526025	Ref. No.	521019
-----------------	--------	-----------------	--------

description	spring \varnothing 12mm L 16mm wire gauge \varnothing 1.45mm
--------------------	--

tap bodies



Part No.	526075	Ref. No.	521107
-----------------	--------	-----------------	--------

description	tap body T1: 1/4" T2: 3/8" T3: M16x1 IT L 35mm
--------------------	--

washers



Part No.	560382	Ref. No.	521382
-----------------	--------	-----------------	--------

description	washer D1 \varnothing 6mm D2 \varnothing 20mm thickness 1.5mm steam/water tap
--------------------	---

screw connections





Part No.	526075	Ref. No.	521010
-----------------	--------	-----------------	--------

description	screw connection T1: M16x1 T2: 1/2" L 51.4mm brass
--------------------	--





water taps			
knobs			
			
1			
Part No.	111142	Ref. No.	000602 + 000.511.40.7
description	knob water		

steam/water pipes			
steam pipes			
			
1			
Part No.	526083	Ref. No.	800203.INOX
description	steam pipe H 180mm ø 14.5mm tube ø 10mm IT M8.5x0.75 stainless steel with plastic hose		

			
1			
Part No.	525773	Ref. No.	800202
description	steam pipe thread 3/8" H 185mm L 235mm W 110mm ø 14.3mm tube ø 10mm stainless steel		
spare parts for	525773		
	Part No.	Ref. No.	800203.INOX
	526083		
	 steam pipe H 180mm ø 14.5mm tube ø 10mm IT M8.5x0.75 stainless steel with plastic hose		

nozzles for steam pipes			
			
1			
Part No.	526082	Ref. No.	800209.INOX
description	nozzle thread M8.5x0.75 ø 12.5mm L 16mm bore ø 1.55mm		

water pipes			
			
1			
Part No.	529629	Ref. No.	800206
description	water pipe ø 15mm L 102mm tube ø 10mm suitable for AURORA		

accessories			
union nuts			
			
1			
Part No.	528337	Ref. No.	000201
description	union nut thread 1/2" L 16mm hole ø 12.5mm brass		

			
1			
Part No.	529706	Ref. No.	521111
description	union nut thread 3/8" L 21mm hole ø 12.5mm brass		

fine filters			
holders			
			
1			
Part No.	528321	Ref. No.	000178
description	filter support D1 ø 13mm ID ø 5mm int. ø 1 11mm H 9mm brass		

fine filters			
			
1			
Part No.	529911	Ref. No.	000179
description	fine filter flat ø 11mm H 0.25mm		

intake valves			
intake valves			
			
1			
Part No.	525771	Ref. No.	800518
description	intake valve water connection 3/8"		

level glasses			
level glasses			
gaskets			
			
1			
Part No.	529424	Ref. No.	000464
description	gasket D1 ø 18.5mm D2 ø 11mm H 13.5mm water level glass suitable for AURORA		



pressure rings



1

Part No.	529409	Ref. No.	000506
-----------------	--------	-----------------	--------

description	press ring D1 ø 20mm D2 ø 18mm thickness 10mm
--------------------	---

level glass pipes



1

Part No.	525766	Ref. No.	000319
-----------------	--------	-----------------	--------

description	water level tube ø 12mm H 155mm ID ø 8mm
--------------------	--

scales



1

Part No.	526020	Ref. No.	000699
-----------------	--------	-----------------	--------

description	sticker L 119mm W 30mm Min/Max transparent
--------------------	--

non-return valves

complete



1

Part No.	526022	Ref. No.	800630
-----------------	--------	-----------------	--------

description	non-return valve T1: 3/8" T2: 3/8" T3: 1/8"
--------------------	---

knobs

steam/water taps

steam/water taps



1

Part No.	111013	Ref. No.	000222
-----------------	--------	-----------------	--------

description	knob ø 51mm thread Tr18x2 black
--------------------	---------------------------------

accessories for	111013
------------------------	--------



Part No.	111008	Ref. No.	521225
-----------------	--------	-----------------	--------

description	knob dial plate water white
--------------------	-----------------------------



Part No.	111009	Ref. No.	521224
-----------------	--------	-----------------	--------

description	knob dial plate steam
--------------------	-----------------------

accessories for	111013
------------------------	--------



Part No.	111277	Ref. No.	521223
-----------------	--------	-----------------	--------

description	nut for knob thread M24x1.5 ED ø 38mm H 21mm
--------------------	--



1

Part No.	111142	Ref. No.	000602 + 000.511.40.7
-----------------	--------	-----------------	-----------------------

description	knob water
--------------------	------------



1

Part No.	111278	Ref. No.	B-MC-0082
-----------------	--------	-----------------	-----------

description	turning handle ø 48.5mm
--------------------	-------------------------

accessories for	111278
------------------------	--------



Part No.	111279	Ref. No.	B-MC-0058
-----------------	--------	-----------------	-----------

description	knob spring ø 29mm L 5mm wire gauge ø 1.1mm
--------------------	---



Part No.	551303	Ref. No.	—
-----------------	--------	-----------------	---

description	cotter pin ø 1.8mm L 17mm steel Qty 20 pcs
--------------------	--

knob dial plates



1

Part No.	111009	Ref. No.	521224
-----------------	--------	-----------------	--------

description	knob dial plate steam
--------------------	-----------------------



1

Part No.	111008	Ref. No.	521225
-----------------	--------	-----------------	--------

description	knob dial plate water white
--------------------	-----------------------------

accessories



1

Part No.	528762	Ref. No.	88 2211
-----------------	--------	-----------------	---------

description	cotter pin ø 1.8mm L 17mm
--------------------	---------------------------



1

Part No.	111142	Ref. No.	000602 + 000.511.40.7
-----------------	--------	-----------------	-----------------------

description	knob water
--------------------	------------



			
1			
Part No.	111277	Ref. No.	521223
description	nut for knob thread M24x1.5 ED ø 38mm H 21mm		

accessories

knob adaptors

			
1			
Part No.	112781	Ref. No.	B-MC-0101
description	adapter for steam-/water-tap ALEXIA		

miscellaneous

			
1			
Part No.	111277	Ref. No.	521223
description	nut for knob thread M24x1.5 ED ø 38mm H 21mm		

handles and hand wheels

lever handles

			
1			
Part No.	111140	Ref. No.	N/A
description	lever handle plastic black suitable for AURORA		

gaskets

O-rings

EPDM

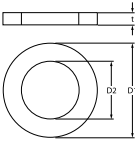
 			
1			
Part No.	528485	Ref. No.	521296
description	O-ring EPDM thickness 1.78mm ID ø 6.07mm Qty 1 pcs		

silicone

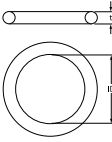
 			
1			
Part No.	532586	Ref. No.	000962
description	O-ring silicone thickness 2.62mm ID ø 40.95mm Qty 1 pcs		

Viton

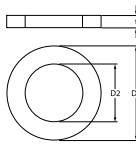
 			
1			
Part No.	528291	Ref. No.	07.0610.15.80
description	O-ring Viton thickness 2.62mm ID ø 11.91mm Qty 1 pcs		

NBR

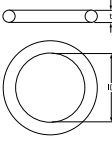
 			
1			
Part No.	532587	Ref. No.	07.0610.08.30 30.000.05.88
description	O-ring NBR thickness 1.78mm ID ø 8.73mm Qty 1 pcs		

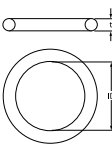
 			
1			
Part No.	532585	Ref. No.	000205
description	O-ring NBR thickness 2.62mm ID ø 10.78mm Qty 1 pcs		

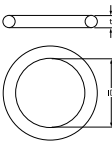
 			
1			
Part No.	532557	Ref. No.	521228
description	O-ring NBR thickness 2.62mm ID ø 12.37mm Qty 1 pcs		

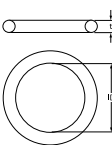
 			
1			
Part No.	532556	Ref. No.	000215
description	O-ring NBR thickness 2.62mm ID ø 13.1mm Qty 1 pcs		



sealing washers

copper gaskets

DIN-7603-C



1

Part No.	510650	Ref. No.	000466
description	gasket copper ED ø 28mm ID ø 22mm thickness 3mm Qty 1 pcs		

PTFE gaskets



1

Part No.	528314	Ref. No.	521226
description	flat gasket PTFE ED ø 20mm ID ø 17mm thickness 2mm Qty 1 pcs suitable for Astoria/Azkoyen/Espresso/Wega		



1

Part No.	527970	Ref. No.	000049
description	flat gasket PTFE ED ø 24mm ID ø 18mm thickness 2mm Qty 1 pcs		

springs

compression springs



1

Part No.	528335	Ref. No.	000204
description	compression spring ø 10mm L 30mm wire gauge ø 1.6mm windings 7		



1

Part No.	525768	Ref. No.	000611
description	compression spring ø 21mm L 23mm wire gauge ø 2mm windings 3		



1

Part No.	526077	Ref. No.	000361
description	compression spring ø 7mm L 26mm wire gauge ø 0.8mm for safety valve		



1

Part No.	528319	Ref. No.	000180
description	compression spring ø 9.1mm L 15mm wire gauge ø 0.6mm windings 4.5		

coffee accessories

milk foamers

milk foamers



1

Part No.	525933	Ref. No.	LAV2012 LAV2012_90° connection
description	milk foamer connection 6mm angle 90° plastic		

accessories for 525933



Part No.	531255	Ref. No.	LAV2012 (Attaco 3/8 „)
description	adapter thread 3/8" L 40mm		

accessories



1

Part No.	531255	Ref. No.	LAV2012 (Attaco 3/8 „)
description	adapter thread 3/8" L 40mm		

accessories for 531255



Part No.	525933	Ref. No.	LAV2012 LAV2012_90° connection
description	milk foamer connection 6mm angle 90° plastic		

manometers



1

Part No.	541279	Ref. No.	407312
description	manometer double scale ø 63mm pressure range 0-2.5 / 0-25bar connection on the backside thread 1/8"		



dosing pumps

accessories

hose couplings

metal



1

Part No.	361184	Ref. No.	521381
description	nut thread 1/2" H 6mm nickel-plated brass WS 24 Qty 1 pcs		

fastening material

screws

flat-headed bolts



1

Part No.	560062	Ref. No.	02.2101.04.10
description	flat-headed bolt thread M4 thread L 10mm SS DIN 7985/ISO 7045 Qty 20 pcs intake Phillips head ø 8mm head thickness 2mm		

hexagonal screws



1

Part No.	560083	Ref. No.	02.2105.05.10
description	hexagonal screw thread M5 thread L 10mm SS WS 8 Qty 20 pcs DIN 933 / ISO 4017		

cylinder head bolts

DIN 912/ISO 4762



1

Part No.	560025	Ref. No.	02.2102.04.10
description	cylinder head bolt thread M4 thread L 10mm WS 3 SS Qty 20 pcs DIN 912/ISO 4762		

nuts

hexagonal nuts

hexagonal nuts inch thread



1

Part No.	361184	Ref. No.	521381
description	nut thread 1/2" H 6mm nickel-plated brass WS 24 Qty 1 pcs		

fasteners

cotter pins



1

Part No.	528762	Ref. No.	88 2211
description	cotter pin ø 1.8mm L 17mm		

GASTROPARTS.COM

