



GASTROPARTS

Brema

- [EN]** Equipment
- [DE]** Geräte
- [ES]** Aparatos
- [FR]** Équipement
- [IT]** Attrezzature
- [PL]** Urządzenia
- [RU]** Оборудование

✉ gastroparts@gastroparts.com

☎ +48 56 657 00 66

📘 fb.com/gastroparts.global

GASTROPARTS.COM





thermostats

bi-metal thermostats

safety bi-metal thermostats



Part No.	390590	Ref. No.	C23114
description	bi-metal safety thermostat hole distance 24mm switch-off temp. °C 1NC 1-poleAV connection plug 2 hole fixing		
For models:	C150, C150-CubeA, C80, C80-CubeA, CB1265, CB1265-CubeA, CB1565, CB1565-CubeA, CB184, CB246, CB246-CubeA, CB249, CB316, CB316-CubeA, CB416, CB425, CB425-CubeA, CB640, CB640-CubeA, CB840, CB955, CB955-CubeA, DSS42, DSS42-CubeD, F230, FB802, FreshMaker, G150, G250, G500, GB1540, GB1555, GB902, GB903, IceWater45, IF26, IF29, IF30, IF55, IF75, IMF28, IMF35, IMF58, IMF80, TB1405, TB852, VB250, VM500		

refrigeration thermostats

RANCO

K22 series

RANCO



Part No.	390587	Ref. No.	23447
description	thermostat RANCO type K22L1069 probe ø 2mm		
For models:	CB640, CB840, CB955, M350, M800		

RANCO



Part No.	390524	Ref. No.	23591 24727 R23591
description	thermostat RANCO type K22L1082 probe ømm probe Lmm capillary pipe 2000mm temperature range -22 up to -3°C		
For models:	C150, C150-CubeA, C300, C300-CubeA, C80, C80-CubeA, CB1265, CB1265-CubeA, CB134, CB1565, CB1565-CubeA, CB184, CB246, CB246-CubeA, CB249, CB316, CB316-CubeA, CB416, CB425, CB425-CubeA, CB640, CB640-CubeA, CB840, CB955, CB955-CubeA, DSS42, DSS42-CubeD, FreshMaker, IC18, IC24, IC24A-CubeA, IC30, IC30A-CubeA, IceWater45, VB250, VM1700		

RANCO



Part No.	390589	Ref. No.	23597 R23597
description	thermostat RANCO type K22L1083 probe ø 2mm probe Lmm capillary pipe 2300mm		
For models:	VM350, VM500, VM900		

K50 series

RANCO



Part No.	390288	Ref. No.	23034
description	thermostat RANCO type K50L3163 probe ømm probe Lmm capillary pipe 2100mm temperature range -24 up to -14°C		
For models:	F230, FB802, G250, G500, GB1540, GB1555, GB902		

RANCO



Part No.	390588	Ref. No.	23421 R23421
description	thermostat RANCO type K50L3274 probe ø 2mm probe Lmm capillary pipe 3000mm		
For models:	C150, C300, C300-CubeA, C80, F230, G1000, G1000-Split, G250, G500, G500-Split, M1500, M1500-Split, M350, M350-Split, M600, M600-Split, M800, M800-Split		

RANCO



Part No.	390286	Ref. No.	23005 R23005
description	thermostat RANCO type K50L3383 probe ømm probe Lmm capillary pipe 1500mm temperature range +1 up to +3°C		
For models:	C150, C150-CubeA, C80, C80-CubeA, CB1265, CB1265-CubeA, CB134, CB1565, CB1565-CubeA, CB184, CB246, CB246-CubeA, CB249, CB316, CB316-CubeA, CB416, CB425, CB425-CubeA, CB640, CB640-CubeA, CB840, CB955, CB955-CubeA, DSS42, DSS42-CubeD, FB802, FreshMaker, G150, GB1540, GB1555, GB902, GB903, IC18, IC24, IC24A-CubeA, IC30, IC30A-CubeA, IceWater45, IF26, IF29, IF30, IF55, IF75, IMF28, IMF35, IMF58, IMF80, M1500, M1500-Split, M350...(Other models you can see in the webshop)		



K61 series

BRANCO



1

Part No.	390287	Ref. No.	23004
description	thermostat BRANCO type K61L1506 probe \varnothing mm probe Lmm capillary pipe 2300mm		

switches and momentary switches

rocker/momentary rocker switches

30x22mm

blank



1

Part No.	345982	Ref. No.	23611
description	rocker switch mounting measurements 30x22mm green 2CO 250V 16A illuminated connection male faston 6.3mm ambient temperature max. 125/55°C protection IP65 with cover cap		

For models: VM350, VM500, VM900

accessories for 345982



Part No.	301036	Ref. No.	—
description	protective cover internal size 30x22mm for rocker switch mounting measurementsmm		

labelled



1

Part No.	300125	Ref. No.	23327
description	rocker switch mounting measurements 30x22mm green 2NO 230V 16A 0-I connection male faston 6.3mm ambient temperature max. 125/55°C protection IP65 with cover cap		

For models: C150, C300, CB1265, CB1265-CubeA, CB134, CB1565, CB1565-CubeA, CB184, CB246, CB246-CubeA, CB249, CB316, CB316-CubeA, CB416, CB425, CB425-CubeA, CB640, CB640-CubeA, CB840, CB955, CB955-CubeA, FB802, FreshMaker, G1000, G150, G250, G500, G500-Split, GB1540, GB1555, GB902, GB903, IC18, IC24, IC24A-CubeA, IC30, IC30A-CubeA, IceWater45, IF26, IF29, IF30, IF55, IF75, IMF28, IMF35, IMF58, IMF80, TB1405, TB852, VB250...(Other models you can see in the webshop)

accessories for 300125



Part No.	301036	Ref. No.	—
description	protective cover internal size 30x22mm for rocker switch mounting measurementsmm		

push/momentary push switches

19x13mm



1

Part No.	346871 ¹	Ref. No.	23619	
description	push switch mounting measurements 19x13mm green 2NO 250V 16A illuminated connection male faston 4.8mm ambient temperature max. 105/55°C protection IP40			
For models:	VM1700, VM350, VM500, VM900			
accessories for	346871			
	Part No.	346541	Ref. No.	—
description	protective cover for rocker switch external size 23.4x17.4mm internal size 19x13mm H 9.5mm mounting measurementsmm			

¹illuminated

2 hole fixing



1

Part No.	346879	Ref. No.	23078
description	push switch green 2NO/indicator light 250V 16A illuminated connection male faston 6.3mm ambient temperature max. 125/55°C protection IP40		
For models:	CB134, CB184		

microswitches

universal



1

Part No.	345042	Ref. No.	23196 23372	
description	microswitch with plunger 250V 16A 1CO connection male faston 6.3mm L 28mm ambient temperature max. 125°C mounting distance 22mm type EF83161.3 actuating force: 75g blue/black			
For models:	G1000, G1000-Split, G150, G250, G500, G500-Split, IF26, IF29, IF30, IF55, IF75			
accessories for	345042			
	Part No.	345043	Ref. No.	—
description	lever set 5-piece			



pin-plunger actuated



1			
Part No.	345042	Ref. No.	23196 23372
description	microswitch with plunger 250V 16A 1CO connection male faston 6.3mm L 28mm ambient temperature max. 125°C mounting distance 22mm type EF83161.3 actuating force: 75g blue/black		
For models:	G1000, G1000-Split, G150, G250, G500, G500-Split, IF26, IF29, IF30, IF55, IF75		
accessories for	345042		
	Part No.	345043	Ref. No. —
	lever set 5-piece		



1			
Part No.	345105	Ref. No.	23055
description	microswitch with plunger 250V 16A 1CO connection male faston 6.3mm L 28mm ambient temperature max. 125°C mounting distance 22mm type SM-51 actuating force: 280g black		
For models:	DSS42, DSS42-CubeD, F230, FB802, FreshMaker, G1000, G1000-Split, G150, G250, G500, G500-Split, GB1540, GB1555, GB902, GB903, IceWater45, TB1405, TB852		

non-standard



1			
Part No.	348181	Ref. No.	23803 C23803 NC23803
description	switch kit mounting distance 48mm 250V 16A 2x1NO connection F6.3 L 57mm		
For models:	IFT65, IMF28, IMF35, IMF58, IMF80		

timers

programme timers



1			
Part No.	360567	Ref. No.	23632
description	timer CDC 11904 engines 1 chambers 4 operation time 10min 220-230V 60Hz shaft ømm shaft Lmm manu. no. 11904F1BCY000.0010 motor type M48R ATS voltage AC		
For models:	VM1700, VM350, VM500, VM900		



1			
Part No.	360525	Ref. No.	23247
description	timer CDC 11904 engines 1 chambers 4 operation time 10min 230V shaft ømm shaft Lmm manu. no. 11904F1 / BCR000.0000 motor type M48R ATS		
For models:	C150, C150-CubeA, C300, C300-CubeA, C80, CB1265, CB1565, CB1565-CubeA, CB184, CB246, CB249, CB316, CB416, CB425, CB640, CB840, CB955, DSS42, DSS42-CubeD, FreshMaker, IC18, IC24, IC30, IceWater45, VB250		
spare parts for	360525		
	Part No.	360118	Ref. No. —
	motor CDC pinion ø 4.9mm teeth 10 230V voltage AC 50/60Hz turn direction right motor ø 47mm H 19.3mm motor type M48R ATS for timer cable length 260mm 1.9/2.5W		



1			
Part No.	360524	Ref. No.	23222
description	timer CDC 11904 engines 1 chambers 4 operation time 12min 230V shaft ømm shaft Lmm manu. no. 11904F1 / BDR000.0000 motor type M48R ATS		
For models:	C150, C150-CubeA, C300, C300-CubeA, C80, C80-CubeA, CB1265, CB1265-CubeA, CB1565, CB1565-CubeA, CB246, CB246-CubeA, CB249, CB316, CB316-CubeA, CB416, CB425, CB425-CubeA, CB640, CB640-CubeA, CB840, CB955, CB955-CubeA, IC24, IC24A-CubeA, IC30, IC30A-CubeA, IceWater45		
spare parts for	360524		
	Part No.	360118	Ref. No. —
	motor CDC pinion ø 4.9mm teeth 10 230V voltage AC 50/60Hz turn direction right motor ø 47mm H 19.3mm motor type M48R ATS for timer cable length 260mm 1.9/2.5W		





1			
Part No.	360566	Ref. No.	23259
description	timer CDC 11904 engines 1 chambers 4 operation time 15min 115V 60Hz shaft ømm shaft Lmm manu. no. 11904F1BEI000.0010 motor type M48R ATS voltage AC		
For models:	C80, C80-CubeA, CB1265, CB1265-CubeA, CB246, CB246-CubeA, CB249, CB316, CB316-CubeA, CB416, CB425, CB425-CubeA, CB640, CB640-CubeA, CB840, CB955, CB955-CubeA, IC24, IC24A-CubeA, IC30, IC30A-CubeA, IceWater45		



			
1			
Part No.	360550	Ref. No.	23248
description	timer CDC 11904 engines 1 chambers 4 operation time 15min 230V 50/60Hz shaft ømm shaft Lmm manuf. no. 11904F1 / BER000.0000		
For models:	C150, C150-CubeA, C300, C80, C80-CubeA, CB1265, CB1265-CubeA, CB1565, CB246, CB246-CubeA, CB249, CB316, CB316-CubeA, CB416, CB425, CB425-CubeA, CB640, CB640-CubeA, CB840, CB955, CB955-CubeA, IC24, IC24A-CubeA, IC30, IC30A-CubeA, IceWater45		
spare parts for	360550		
	Part No.	360118	Ref. No. —
motor CDC pinion ø 4.9mm teeth 10 230V voltage AC 50/60Hz turn direction right motor ø 47mm H 19.3mm motor type M48R ATS for timer cable length 260mm 1.9/2.5W			

			
1			
Part No.	360565	Ref. No.	23396 23780
description	timer CDC 11904 engines 1 chambers 4 operation time 18min 230V 50/60Hz shaft ømm shaft Lmm manuf. no. 11904F1BFE000.0030 motor type M48R ATS voltage AC		
For models:	C150, C300, C80, CB1265, CB1565, CB246, CB249, CB316, CB416, CB425, CB640, CB840, CB955, IC30, IceWater45		

			
1			
Part No.	360549	Ref. No.	23635
description	timer CDC 11904 engines 1 chambers 4 operation time 8min 230V 50/60Hz shaft ømm shaft Lmm manuf. no. 11904F1 / DER000.0010		
For models:	VM1700, VM350, VM500, VM900		
spare parts for	360549		
	Part No.	360118	Ref. No. —
motor CDC pinion ø 4.9mm teeth 10 230V voltage AC 50/60Hz turn direction right motor ø 47mm H 19.3mm motor type M48R ATS for timer cable length 260mm 1.9/2.5W			

			
1			
Part No.	360620	Ref. No.	23472 23472/1
description	timer CDC operation time 8min engines 1 chambers 4 230V shaft ømm shaft Lmm manuf. no. 23472/1 motor type M48R ATS 11904F1/4114		
For models:	C150, C300, CB1565		

			
1			
Part No.	360060	Ref. No.	23003
description	timer FIBER P20 engines 1 chambers 4 operation time 12min 230V shaft ømm shaft Lmm		
For models:	C150, C150-CubeA, C80, C80-CubeA, CB184, CB246, CB246-CubeA, CB249, CB316, CB316-CubeA, CB416, CB425, CB425-CubeA, CB640, CB640-CubeA, CB840, CB955, CB955-CubeA		

contactors

LOVATO

power contactors

			
1			
Part No.	380704	Ref. No.	23092
description	power contactor resistive load 20A 230VAC (AC3/400V) 9A/4kW main contacts 3NO auxiliary contacts 1NC connection screw connection type 11BG0901A230		
For models:	F230, FB802		



1

Part No.	380964	Ref. No.	23594
description	power contactor resistive load 20A 230VAC (AC3/400V) 9A/4kW main contacts 4NO auxiliary contacts connection screw connection type 11BG09T4A230		
For models:	C150, C150-CubeA, CB1565, CB1565-CubeA, G1000, G500-Split, M1500-Split, M2000, M2000-Split, M350-Split, M600-Split, M800-Split, VM350		



1

Part No.	381253	Ref. No.	23903
description	supervisory relay three-phase 575V PMV30 LOVATO		
For models:	M2000, M2000-Split, VM1700		

relays

power relays

with bracket mounting



1

Part No.	380312	Ref. No.	23190
description	power relays FINDER 230VAC 10A 3CO connection male faston 4.8mm bracket mounting dimensions 52x32.2x36.5mm manuf. no. 60.63.8.230.0000		
For models:	G1000, G1000-Split, G150, G500-Split, GB1540, GB1555, GB902, GB903, IF26, IF29, IF30, IF55, IF75, IMF28, IMF35, IMF58, IMF80, M350, M800, TB1405, TB852, VM500, VM900		

supervisory relays



1

Part No.	401610	Ref. No.	23633
description	supervisory relay revolutions		
For models:	G1000, G250, G500		

time relays

time relays



1

Part No.	380783	Ref. No.	23560
description	time relay CROUZET TAR1-88865115 time range 0.1s-100h 24-240VAC/24VDC 8A		
For models:	DSS42, G1000, G150, G250, G500, VM500, VM900		

probes

sensors



1

Part No.	401611	Ref. No.	23676 R231028 R23676
description	sensor ø 18mm L 44mm thread M10x1 cable length 1450mm		
For models:	G1000, G1000-Split, G250, G500, G500-Split		
accessories for	401611		
	Part No.	521129	Ref. No. —
	nut thread M10 H 6mm SS WS 17 Qty 1 pcs DIN/ISO DIN 439		



solenoid valves

solenoid valves (water)

ELBI



1

Part No.	370443	Ref. No.	23144
description	solenoid valve triple straight 230VAC inlet 3/4" outlet 11.5mm t.max. 90°C ELBI plastic output A 2l/min output B 0.5l/min output C 0.5l/min flow regulating valve outlet A white flow regulating valve outlet B red flow regulating valve outlet C red		
For models:	FreshMaker		



1

Part No.	370444	Ref. No.	C23174
description	solenoid valve triple straight 230VAC inlet 3/4" outlet 11.5mm t.max. 90°C ELBI plastic output A 2l/min output B 0.5l/min output C 2.5l/min flow regulating valve outlet A white flow regulating valve outlet B red flow regulating valve outlet C orange		
For models:	IceWater45		

RPE



1

Part No.	370441	Ref. No.	10239
description	solenoid valve single straight inlet 3/4" input 10-12l/min output 6l/min RPE flow regulating valve inlet white		
For models:	C300, G1000, M1500, M2000, M350, M350-Split, M600, M600-Split, M800, M800-Split, VM500, VM900		

solenoid valves with reducers

single



1

Part No.	370440	Ref. No.	10368
description	solenoid valve 1-fold, without membrane (constantly open) angled inlet 3/4" outlet 11.5mm input 10-12l/min RPE plastic flow regulating valve inlet white		
For models:	C150, G250, G500, M1500-Split, M2000-Split, M350-Split, M600-Split, M800-Split		

TP

solenoid valves with reducers



1

Part No.	370777	Ref. No.	BR23781
description	solenoid valve double angled 230VAC inlet 3/4" output 1.5/2.5l/min TP outlet 11.5mm output A yellowl/min output B brownl/min		



1

Part No.	370437	Ref. No.	23010 C23501
description	solenoid valve double angled 230VAC inlet 3/4" input 10l/min output 1.2/1.2l/min DN10 t.max. 90°C TP plastic flow regulating valve inlet white outlet 11.5mm output A 1.2l/min output B 1.2l/min flow regulating valve outlet A dark brown flow regulating valve outlet B dark brown		
For models:	C80, C80-CubeA, CB416, CB425, CB425-CubeA, CB640, CB640-CubeA, CB840, CB955, CB955-CubeA, DSS42, DSS42-CubeD, G150, GB1540, GB1555, IF30, IMF28, TB1405, VB250		



1

Part No.	370436	Ref. No.	23498
description	solenoid valve double angled 230VAC inlet 3/4" inputl/min output 0.6/0.6l/min DN10 t.max. 90°C TP plastic outlet 11.5mm output A 0.6l/min output B 0.6l/min flow regulating valve outlet A orange flow regulating valve outlet B orange		
For models:	CB184		





1

Part No.	370395	Ref. No.	23116
description	solenoid valve double angled 230VAC inlet 3/4" inputl/min output 0.8/0.8l/min DN10 t.max. 90°C TP plastic outlet 11.5mm output A 0.8l/min output B 0.8l/min flow regulating valve outlet A white flow regulating valve outlet B white		
For models:	CB316, CB316-CubeA, FB802, GB902, GB903, TB852		





			
1			
Part No.	370434	Ref. No.	23157
description	solenoid valve double angled 230VAC inlet 3/4" input/min output 2,5/2,5l/min DN10 t.max. 90°C TP plastic outlet 11.5mm output A 2.5l/min output B 2.5l/min flow regulating valve outlet A yellow flow regulating valve outlet B yellow		
For models:	C300, C300-CubeA, CB1265, CB1265-CubeA		

			
1			
Part No.	370447	Ref. No.	C23191
description	solenoid valve double angled 230VAC inlet 3/4" t.max. 90°C TP plastic outlet 11.5mm output A 1.2l/min output B 1.2l/min flow regulating valve outlet A dark brown flow regulating valve outlet B dark brown		
For models:	IceWater45		

			
1			
Part No.	370435	Ref. No.	23542
description	solenoid valve double angled 230VAC inlet 3/4" t.max. 90°C TP plastic outlet 11.5mm output A 0.5l/min output B 0.8l/min flow regulating valve outlet A orange flow regulating valve outlet B white		
For models:	CB246, CB246-CubeA, CB249		

			
1			
Part No.	370439	Ref. No.	23138
description	solenoid valve double angled 230VAC inlet 3/4" t.max. 90°C TP plastic outlet 11.5mm output A 2.5l/min flow regulating valve outlet A yellow output B w/t membrane (constantly open)		
For models:	C150, C150-CubeA, CB1565, CB1565-CubeA		

			
1			
Part No.	370446	Ref. No.	C23192
description	solenoid valve double angled 230VAC inlet 3/4" t.max. 90°C TP plastic outlet 11.5mm output A 0.8l/min output B 2.5l/min flow regulating valve outlet A white flow regulating valve outlet B yellow output B w/t membrane (constantly open)		
For models:	F230, G250, G500		

			
1			
Part No.	370445	Ref. No.	23501
description	solenoid valve double angled 230VAC inlet 3/4" t.max. 90°C TP plastic outlet 11.5mm output A 2.5l/min output B 0.8l/min flow regulating valve outlet A yellow flow regulating valve outlet B white		
For models:	IF30, IF55, IF75, IMF35, IMF58, IMF80		

			
1			
Part No.	370438	Ref. No.	23502
description	solenoid valve double angled 230VAC inlet 3/4" t.max. 90°C TP plastic outlet 11.5mm output A 1.2l/min output B 0.8l/min flow regulating valve outlet A dark brown flow regulating valve outlet B white		
For models:	CB425, IF26, IF29, IMF28		

			
1			
Part No.	370449	Ref. No.	23220
description	solenoid valve single angled 230VAC inlet 3/4" outlet 11.5mm input 2.5l/min output/min DN10 t.max. 90°C TP plastic flow regulating valve inlet yellow		
For models:	C150, C80, CB1265, CB1565, CB640, CB840, CB955, IceWater45, IF30, IF55, IF75, IMF35, IMF58, IMF80, VM350		



1

Part No.	370451	Ref. No.	23641 23787 23819
description	solenoid valve single angled 230VAC inlet 3/4" outlet 11.5mm input 3l/min t.max. 90°C TP plastic flow regulating valve inlet red		
For models:	C150, CB1265, CB1565, VM1700, VM350, VM500		



1

Part No.	370450	Ref. No.	23623
description	solenoid valve single angled 230VAC inlet 3/4" outlet 11.5mm input 5l/min t.max. 90°C TP plastic flow regulating valve outlet white flow regulating valve inlet pink		
For models:	VM900		



1

Part No.	370426	Ref. No.	23497
description	solenoid valve single angled 230VAC inlet 3/4" outlet 11.5mm input/min output 0.6l/min DN10 t.max. 90°C TP plastic flow regulating valve outlet orange		
For models:	CB134, CB184, CB246, CB246-CubeA, CB249		



1

Part No.	370399	Ref. No.	23115
description	solenoid valve single angled 230VAC inlet 3/4" outlet 11.5mm input/min output 0.8l/min DN10 t.max. 90°C TP plastic		
For models:	CB316, CB316-CubeA, F230, FB802, G150, G250, G500, G500-Split, GB1540, GB1555, GB902, GB903, TB1405, TB852		



1

Part No.	370427	Ref. No.	23001
description	solenoid valve single angled 230VAC inlet 3/4" outlet 11.5mm input/min output 1.2l/min DN10 t.max. 90°C TP plastic flow regulating valve outlet dark brown		
For models:	C80, C80-CubeA, CB416, CB425, CB425-CubeA, CB640, CB640-CubeA, CB840, CB955, CB955-CubeA, DSS42, DSS42-CubeD, G1000, G1000-Split, IF26, IF29, IMF28, VB250		



1

Part No.	370401	Ref. No.	23108
description	solenoid valve single angled 230VAC inlet 3/4" outlet 11.5mm output 2.5l/min t.max. 90°C TP plastic flow regulating valve outlet yellow		
For models:	C150, C150-CubeA, CB1265, CB1265-CubeA, CB1565, CB1565-CubeA, IceWater45, VM350		

various



1

Part No.	370448	Ref. No.	23537
description	solenoid valve single angled 230VAC cable length 600mm inlet 1/4" mm		
For models:	VM1700, VM350, VM500, VM900		







solenoid valves (refrigeration)

CASTEL
valve bodies
STANDARD series

suitable for refrigerants R22, R134a, R404A, R407C, R410A, R507







Part No.	370151	Ref. No.	20410
description	solenoid valve body NC type 1028/2 S p max 45bar connection 1/4" soldering connection DN 2.2mm -35 up to +105°C L 125mm refrigeration straight CASTEL		
For models:	C80, C80-CubeA, CB184, CB246, CB246-CubeA, CB249, CB316, CB316-CubeA, CB416, CB425, CB425-CubeA, CB640, CB640-CubeA, CB840, CB955, CB955-CubeA, DSS42, DSS42-CubeD, FreshMaker, IC18, IC24, IC24A-CubeA, IC30, IC30A-CubeA, IceWater45, IF26, IF29, IF30, IF55, IF75, IMF28, IMF35, IMF58, IMF80		

accessories for	370151		
	Part No.	371084	Ref. No. —
	solenoid coil CASTEL 230VAC 8VA 50/60Hz connection cable 1000mm type CM2		
	Part No.	371090	Ref. No. —
	power socket plug type DIN 43650A screw		
	Part No.	371301	Ref. No. —
	solenoid coil CASTEL 110VAC 8VA 50/60Hz seat ø 11.5mm connection DIN 43650A type HF2		
	Part No.	371314	Ref. No. —
	solenoid coil CASTEL 240VAC 8VA 50/60Hz seat ø 11.5mm		
	Part No.	371321	Ref. No. —
	solenoid coil CASTEL 12/24VAC 50/60Hz seat ø 11.5mm connection DIN 43650A type HF2		



Part No.	370383	Ref. No.	20409
description	solenoid valve body NC type 1068/M10S p max 45bar connection 10mm soldering connection DN 7mm -35 up to +105°C L 111mm refrigeration straight CASTEL		
For models:	C150, C150-CubeA, C300, C300-CubeA, CB1265, CB1265-CubeA, CB1565, CB1565-CubeA, CB840, CB955, CB955-CubeA, M1500, M2000, M350, M600, VB250, VM350, VM500, VM900		

accessories for	370383		
	Part No.	371084	Ref. No. —
	solenoid coil CASTEL 230VAC 8VA 50/60Hz connection cable 1000mm type CM2		
	Part No.	371090	Ref. No. —
	power socket plug type DIN 43650A screw		

accessories for	370383		
	Part No.	371301	Ref. No. —
	solenoid coil CASTEL 110VAC 8VA 50/60Hz seat ø 11.5mm connection DIN 43650A type HF2		
	Part No.	371314	Ref. No. —
	solenoid coil CASTEL 240VAC 8VA 50/60Hz seat ø 11.5mm		
	Part No.	371321	Ref. No. —
	solenoid coil CASTEL 12/24VAC 50/60Hz seat ø 11.5mm connection DIN 43650A type HF2		

various
valve bodies

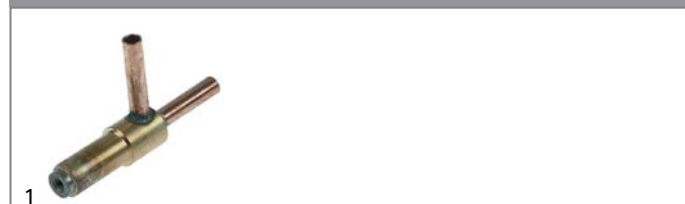

Part No.	370478	Ref. No.	20853
description	solenoid valve body connection 6mm soldering connection refrigeration angled 90°		
For models:	CB134, CB184, FreshMaker, IC18		

pressure switches

service kits

	Part No.	543035	Ref. No.	C23809 KIT23870
	description	service kit for ice maker ø 55mm pressure range 28/12mbar		
	For models:	IMF28, IMF35, IMF58, IMF80		

for warewashing

ø 58mm with male faston 6.3mm
with connection horizontal

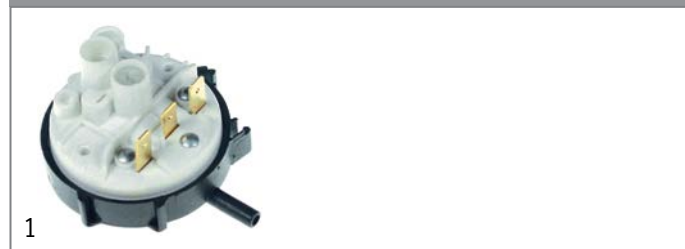

Part No.	541045	Ref. No.	23870
description	pressure control pressure range 28/12mbar connection 6mm ø 58mm pressure connection horizontal warewashing		



for refrigeration

DANFOSS



Part No.	541481	Ref. No.	K23763
description	pressure control ND conversion kit pressure range -0.9 up to +7.0bar switching diff. 0.7bar reset manual pressure connection vertical refrigeration type KP1 060-1109		
For models:	G1000		

SAGI NO MIYA

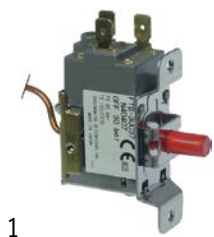

Part No.	541480	Ref. No.	23342
description	pressure control HD reset manual p max 33bar refrigeration type FTB-3UC37 connection male faston 6.3mm switch-off pressure 30bar -20 to +70°C		
For models:	C150, C150-CubeA, C300, C300-CubeA, G1000, G250, G500, M1500, M2000, M350, M600, M800, VM350, VM500, VM900		



Part No.	541479	Ref. No.	23175
description	pressure control HD reset automatic refrigeration type HTB-X114 connection 2.4mm		
For models:	C150, C150-CubeA, C300, C300-CubeA, C80, C80-CubeA, CB1265, CB1265-CubeA, CB1565, CB1565-CubeA, CB184, CB246, CB246-CubeA, CB249, CB316, CB316-CubeA, CB416, CB425, CB425-CubeA, CB640, CB640-CubeA, CB840, CB955, CB955-CubeA, DSS42, DSS42-CubeD, F230, FB802, G1000, G150, G250, G500, GB1540, GB1555, GB902, GB903, IceWater45, IF26, IF29, IF30, IF55, IF75, IMF28, IMF35, IMF58, IMF80, M350, M800, TB1405, TB852...(Other models you can see in the webshop)		

PRESSURE SWITCHES/COMPRESSORS BREMA

compressors

ACC/ZEL

R404a/R507

HMBP monophasé

High/Medium evaporation temperature above -20/-15 °C



Part No.	605068	Ref. No.	23886
description	compressor coolant R404a/R507 type ML45TB 220-240V 50Hz HMBP fully hermetic 10kg 1/5HP cylinder capacity 4.5cm³ CSIR H 175.5mmW 192W 246W 309W 382W 465W 557W 659W 771W test method ASHRAE		

EMBRACO / ASPERA

R134A

HBP monophasé

High evaporation temperature above -15°C



Part No.	605086	Ref. No.	23857
description	compressor coolant R134a type EMT45HDR 220-240V 50Hz HBP fully hermetic 7.7kg 1/8HP power inputW cylinder capacity 3.97cm³ CSIRWW 162W 207W 256W 314W 383W 467W test method ASHRAE		
For models:	CB134		



R404a/R507

HMBP monophase

High/Medium evaporation temperature above -20/-15 °C



1

Part No.	605139	Ref. No.	23985
description	compressor coolant R404a/R507 type EMT6165GK 220-240V 50Hz HMBP 7.92kg 1/4HP cylinder capacity 5.19cm ³ CSIR H 180mmWW 315W 384W 477W 570W 689W 808W test method ASHRAE		



1

Part No.	605161	Ref. No.	23505
description	compressor coolant R404a/R507 type NEK6210GK 220-240V 50Hz HMBP fully hermetic 8.5kg 3/8HP cylinder capacity 8.78cm ³ CSIR H 200mmW 566W 674W 815W 988W 1195W 1435W 1707W		
For models:	CB425, CB425-CubeA, CB640, CB640-CubeA, GB1540, GB1555		



1

Part No.	605178	Ref. No.	23875
description	compressor coolant R404a/R507 type NEK6217GK 220-240V 50Hz HMBP 11.6kg 5/8HP cylinder capacity 14.3cm ³ CSIR H 206mmW 777W 954W 955W 1171W 1386W 1651W 1916W		
For models:	C80, CB840, VB250		



1

Part No.	605190	Ref. No.	23438
description	compressor coolant R404a/R507 type NJ9232GK 220-240V 50Hz HMBP 22.1kg 1 1/4HP cylinder capacity 26.2cm ³ CSIR H 277mmWW 1093W 1470W 1911W 2413W 2973W 3588W 4255W ambient temperature max. 45°C		
For models:	C150, C150-CubeA, CB1565, CB1565-CubeA, VM350		

L'UNITE HERMETIQUE / TECUMSEH

R404A

HMBP monophase

High/Medium evaporation temperature above -20/-15 °C



1

Part No.	605025	Ref. No.	23441
description	compressor coolant R404A type AE4430Z-FZ 220-240V 50Hz HMBP fully hermetic 10.2kg 1/4HP power input 427W cylinder capacity 5.7cm ³ CSIR H 186mmWW 258W 346W 441W 550W 682W 794W test method EN 12900 908W		
For models:	CB249, CB316, CB316-CubeA, CB416, FB802, GB902, GB903, IC30, IC30A-CubeA, IF55, IMF58, TB852		

spare parts for	605025		
	Part No.	380061	Ref. No.
			—
		start relay MTRP0027-31 120/240V voltage AC 8A 1NO	



			
1			
Part No.	605036	Ref. No.	23444
description	compressor coolant R404A type AEZ4425Z 220-240V 50Hz 9.8kg 1/5HP power inputW cylinder capacity 4.5cm ³ CSIR H 186mmWW 198W 263W 341W 432WWWW		
For models:	C80, C80-CubeA, CB955, CB955-CubeA		

			
1			
Part No.	605021	Ref. No.	23436
description	compressor coolant R404A type AEZ4425Z 220-240V 50Hz HMBP fully hermetic 9.8kg 1/5HP cylinder capacity 4.5cm ³ CSIR H 186mmWW 198W 263W 341W 432W 537W 629W test method EN 12900 723W		
For models:	CB184, CB246, CB246-CubeA, CB249, FreshMaker, IC18, IC24, IC24A-CubeA, IF26, IF29, IF30, IMF28, IMF35		

			
1			
Part No.	605022	Ref. No.	23437
description	compressor coolant R404A type AEZ4440Z 230V 50Hz HMBP fully hermetic 21kg cylinder capacity 7.55cm ³ CSIR H 292mm 415W 517W 637W 772W 919W 1074W test method EN 12900 1234W		
For models:	CB416, DSS42, DSS42-CubeD, IceWater45, IF75, IMF80		

			
1			
Part No.	605026	Ref. No.	23503
description	compressor coolant R404A type CAJ9480Z 220-240V 50Hz HMBP fully hermetic 22kg 3/4HP cylinder capacity 15.2cm ³ CSR H 271mm 393W 571W 774W 1009W 1284W 1607W 1989W 2334W test method EN 12900 2699W		
For models:	C80, C80-CubeA, CB840, VB250		

			
1			
Part No.	605032	Ref. No.	23440
description	compressor coolant R404A type CAJ9510Z 220-240V 50Hz HMBP fully hermetic 23kg 1HP cylinder capacity 18.3cm ³ CSR H 282mm 527W 732W 970W 1252W 1583W 1972W 2437W 2826W test method EN 12900 3220W		
For models:	CB1265, CB1265-CubeA		

miscellaneous

R404A

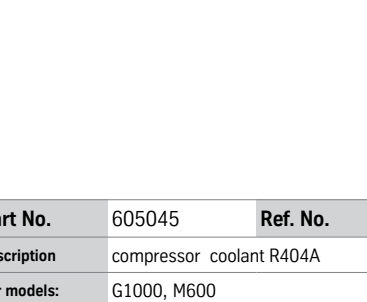
			
1			
Part No.	605045	Ref. No.	23583
description	compressor coolant R404A		
For models:	G1000, M600		

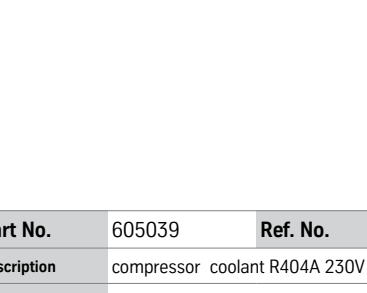
			
1			
Part No.	605039	Ref. No.	23543
description	compressor coolant R404A 230V		
For models:	G500, VM500		



1			
Part No.	605043	Ref. No.	23575
description	compressor coolant R404A 230V		
For models:	GB1540, GB1555		

1			
Part No.	605038	Ref. No.	23453
description	compressor coolant R404A 400V		
For models:	C300, C300-CubeA, VM900		

1			
Part No.	605044	Ref. No.	23570
description	compressor coolant R404A 230V		
For models:	G250		

1			
Part No.	605040	Ref. No.	23589
description	compressor coolant R404A 400V		
For models:	G500		

1			
Part No.	605046	Ref. No.	23448
description	compressor coolant R404A 230V		
For models:	M350		

1			
Part No.	605041	Ref. No.	23588
description	compressor coolant R404A 400V		
For models:	G500, VM500		

1			
Part No.	605047	Ref. No.	23514
description	compressor coolant R404A 230V		
For models:	M350		

1			
Part No.	605048	Ref. No.	23450
description	compressor coolant R404A 400V		
For models:	M350		

1			
Part No.	605042	Ref. No.	23647
description	compressor coolant R404A 230V 50Hz		
For models:	C300, VM900		

1			
Part No.	605049	Ref. No.	23516
description	compressor coolant R404A 400V		
For models:	M350		



1

Part No.	605050	Ref. No.	23518
description	compressor coolant R404A 400V		
For models:	M800		

2

Part No.	605051	Ref. No.	23648
description	compressor coolant R404A 400V		
For models:	M800		

fans

axial fans

import



1

Part No.	601510 ¹	Ref. No.	C23856
description	axial fan L 119mm W 119mm H 38mm 230VAC 50/60Hz 22/21W bearing ball bearing connection male faston 6.3mm SUNON temp.-resist. 70°C		

¹with ball bearings

refrigeration fans

refrigeration motors universal

ELCO

BT series - capacitor motors



1

Part No.	601420 ¹	Ref. No.	23121 23121F
description	fan motor 45W 230V 50Hz L1 53mm L2 18mm L3 120mm W 103mm cable length 500mm 1300rpm ELCO 3FBT 50-40/15 3 mounting options bearing slide bearing		
For models:	C150, C150-CubeA, C300, C300-CubeA, CB1565, CB1565-CubeA, G250, G500, M350, M600, M800, VM350, VM500, VM900		

¹incl. capacitor

accessories

fan wheels

aluminium

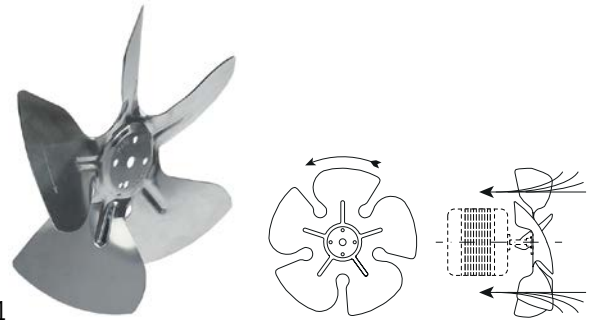

1

Part No.	601385	Ref. No.	20095
description	fan wheel sucking ø 172mm fan wheel mounting 25.4mm blade angle 34° W 42mm aluminium		
For models:	CB184, FB802, GB902, GB903, IC18, IC24, IC24A-CubeA, IC30, IC30A-CubeA, IF26, IF29, IF30, IF55, IMF28, IMF35, M350		

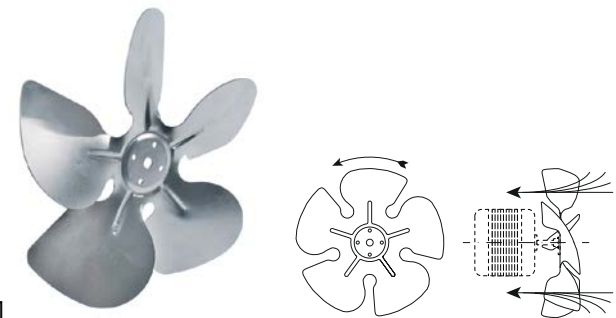

1

Part No.	601282	Ref. No.	20096
description	fan wheel sucking ø 200mm fan wheel mounting 25.4mm blade angle 34° W 44mm aluminium		
For models:	CB640, FB802, GB1540, GB1555, GB902, GB903, IC30, IF55, IF75, IMF58, TB852		



1

Part No.	601414	Ref. No.	20031
description	fan wheel sucking \varnothing 254mm fan wheel mounting 25.4mm blade angle 31° W 46mm aluminium		
For models:	C150, C150-CubeA, C300, C300-CubeA, C80, C80-CubeA, CB1265, CB1265-CubeA, CB640, CB640-CubeA, CB840, CB955, CB955-CubeA, F230, G150, GB1540, GB1555, IF75, IMF80, TB1405, VB250, VM350		

1

Part No.	601415	Ref. No.	20153
description	fan wheel sucking \varnothing 275mm fan wheel mounting 25.4mm blade angle 31° W 62mm aluminium		
For models:	C150, C150-CubeA, C300, C300-CubeA, CB1565, CB1565-CubeA, M350, M600, VM500		

1

Part No.	601410	Ref. No.	20407
description	fan wheel sucking \varnothing 300mm fan wheel mounting 25.4mm blade angle 28° W 45mm aluminium		
For models:	C150, C150-CubeA, CB1565, CB1565-CubeA, G250, G500, M350, M800, VM350, VM500, VM900		

plastic

1

Part No.	601412	Ref. No.	10213
description	fan wheel sucking \varnothing 154mm fan wheel mounting 25.4mm blade angle 28° W 34mm plastic		
For models:	C150, C150-CubeA, C300, C300-CubeA, C80, C80-CubeA, CB1265, CB1265-CubeA, CB1565, CB1565-CubeA, CB184, CB246, CB246-CubeA, CB249, CB316, CB316-CubeA, CB416, CB425, CB425-CubeA, CB640, CB640-CubeA, CB840, CB955, CB955-CubeA, DSS42, DSS42-CubeD, F230, FB802, G150, G250, G500, GB1540, GB1555, GB902, GB903, IC30, IC30A-CubeA, IceWater45, IF26, IF29, IF30, IF55, IF75, TB1405, TB852		

cooling motors (complete)

1

Part No.	601421	Ref. No.	23037
description	fan 230V 10W fan wheel \varnothing 154mm blade angle 28°		
For models:	IC30, IC30A-CubeA		

cold air circulating fans (complete)

ebm-papst

A4E series

1

Part No.	601422	Ref. No.	23468	
description	fan A4E350-AA06-01 fan wheel \varnothing 350mm blades 5 230V 50Hz 140W 1390rpm cable length 450mm ebm-papst sucking			
For models:	G1000, M1500, M800, VM1700			
accessories for	601422			
	Part No.	365172	Ref. No.	—
	capacitor capacity 5 μ F 425V tolerance 5% 50/60Hz ambient temperature max.°C \varnothing 30mm L 55mm M8 plastic connection cable 500mm 416.17.83 protection			



motors

gear motors

for ice-cube maker

for paddles



1

Part No.	501589	Ref. No.	23802
description	gear motor Guaitani type PN40112 220V 50Hz shaft \varnothing 4x3.7mm shaft L 12.6mm for ice maker motor type UDS40NE1RMZ165 cable length 300mm		
For models:	IMF28, IMF35, IMF58		



1

Part No.	501560	Ref. No.	23801
description	gear motor SAIA type UDR1ND5D08AAN8EZ68 230V voltage AC 50/60Hz 8.0rpm shaft \varnothing 4x3mm		
For models:	IMF80		

miscellaneous



1

Part No.	500676	Ref. No.	23571
description	gear motor		
For models:	G1000, G250, G500		

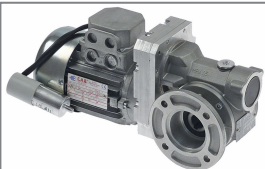

1

Part No.	500678	Ref. No.	C23363
description	gear motor		
For models:	M350, M350-Split		



1

Part No.	500679	Ref. No.	C23412
description	gear motor		
For models:	M1500, M1500-Split, M350, M350-Split, M600, M800, M800-Split		



1

Part No.	500675	Ref. No.	23532 R231030
description	gear motor 220/240V 50Hz for flake ice maker		
For models:	G150, G250, GB1540, GB1555, GB902, GB903, TB1405, TB852		



1

Part No.	500677	Ref. No.	23638
description	gear motor FIR 220-240V 50/60Hz 1350/1650rpm for flake ice maker 300W		
For models:	G1000, G1000-Split, G250, G500, G500-Split		



1

Part No.	500914	Ref. No.	23310
description	gear motor KENTA type K9117403 100W 230V 20rpm shaft \varnothing 12mm L 155mm W 60mm H 85mm		
For models:	DSS42, DSS42-CubeD		



pumps

pumps for ice machines



1

Part No.	601413	Ref. No.	10014
description	fixing plate suitable for fanwheel ED ø 32mm shaft ø 7 mounting distance 26mm		
For models:	C150, C150-CubeA, C300, C300-CubeA, C80, C80-CubeA, CB1265, CB1265-CubeA, CB1565, CB1565-CubeA, CB246, CB246-CubeA, CB249, CB316, CB316-CubeA, CB416, CB425, CB425-CubeA, CB640, CB640-CubeA, CB840, CB955, CB955-CubeA, DSS42, DSS42-CubeD, IceWater45		





1

Part No.	530639	Ref. No.	10066
description	impellor suitable for REBO ø 42mm ID ø 6x7mm H 17mm		
For models:	CB134, CB184, FreshMaker, IC18, IC24, IC30, M1500, M1500-Split, M2000, M2000-Split, VM500, VM900		





1

Part No.	500590	Ref. No.	23377 C23377
description	pump FIR type 4240.2300 120W 230V 50/60Hz inlet ø 22mm outlet ø 22mm L 240mm rotation direction right for ice-cube maker capacitor 5µF		
For models:	C80, CB246, CB249, CB316, CB416, CB425, CB640, CB840, CB955, DSS42, IceWater45		
spare parts for	500590		
	Part No.	601412	Ref. No. 10213
	fan wheel sucking ø 154mm fan wheel mounting 25.4mm blade angle 28° W 34mm plastic		
	Part No.	601413	Ref. No. 10014
	fixing plate suitable for fanwheel ED ø 32mm shaft ø 7 mounting distance 26mm		



1

Part No.	500591	Ref. No.	C23691
description	pump FIR type 4240.2301 120W 230V 50/60Hz inlet ø 22mm outlet ø 22mm L 260mm rotation direction right capacitor 5µF		
spare parts for	500591		
	Part No.	601412	Ref. No. 10213
	fan wheel sucking ø 154mm fan wheel mounting 25.4mm blade angle 28° W 34mm plastic		
	Part No.	601413	Ref. No. 10014
	fixing plate suitable for fanwheel ED ø 32mm shaft ø 7 mounting distance 26mm		





1

Part No.	500660	Ref. No.	C23462
description	pump FIR type 4240A.2300 120W 230V 50/60Hz inlet ø 22mm outlet ø 22mm L 230mm rotation direction right for ice-cube maker capacitor 5µF		
For models:	C150		



1





Part No.	499233	Ref. No.	C23858
description	pump REBO 45W 220/240V 50Hz inlet ø 19mm outlet ø 17mm L 110mm rotation direction left for ice-cube maker		
For models:	CB134, CB184, FreshMaker, IC18		
spare parts for	499233		
	Part No.	530639	Ref. No. 10066
	impellor suitable for REBO ø 42mm ID ø 6x7mm H 17mm		











1

Part No.	501594	Ref. No.	23818 new version K231218
description	pump REBO type 63/35 120W 220/240V 50/60Hz inlet ø 20mm outlet ø 15mm L 250mm for ice-cube maker capacitor 3µF with temperature protection		





			
1			
Part No.	500165	Ref. No.	23002 C23002
description	pump REBO type 63/35 120W 230V 50/60Hz inlet \varnothing 28mm outlet \varnothing 26mm L 180mm rotation direction right for ice-cube maker capacitor 5 μ F		
For models:	C80, C80-CubeA, CB246, CB246-CubeA, CB249, CB316, CB316-CubeA, CB416, CB425, CB425-CubeA, CB640, CB640-CubeA, CB840, CB955, CB955-CubeA, DSS42, DSS42-CubeD, IceWater45		
spare parts for	500165		
	Part No.	365017	Ref. No. —
	operating capacitor capacity 5 μ F 450V tolerance 5% 50/60Hz ambient temperature max. -25 to +85°C \varnothing 28mm L 54mm M8 plastic connection male faston 6.3mm 16.10.08 protection		
	Part No.	601412	Ref. No. 10213
	fan wheel sucking \varnothing 154mm fan wheel mounting 25.4mm blade angle 28° W 34mm plastic		
	Part No.	601413	Ref. No. 10014
	fixing plate suitable for fanwheel ED \varnothing 32mm shaft \varnothing 7 mounting distance 26mm		

			
1			
Part No.	500166	Ref. No.	C23068
description	pump REBO type 63/45 150W 230V 50/60Hz inlet \varnothing 28mm outlet \varnothing 26mm L 200mm rotation direction right capacitor 5 μ F		
For models:	C150		
spare parts for	500166		
	Part No.	365017	Ref. No. —
	operating capacitor capacity 5 μ F 450V tolerance 5% 50/60Hz ambient temperature max. -25 to +85°C \varnothing 28mm L 54mm M8 plastic connection male faston 6.3mm 16.10.08 protection		
	Part No.	601412	Ref. No. 10213
	fan wheel sucking \varnothing 154mm fan wheel mounting 25.4mm blade angle 28° W 34mm plastic		
	Part No.	601413	Ref. No. 10014
	fixing plate suitable for fanwheel ED \varnothing 32mm shaft \varnothing 7 mounting distance 26mm		

			
1			
Part No.	499232	Ref. No.	C26557
description	pump REBO type NR40 55W 220/240V 50Hz inlet \varnothing 19mm outlet \varnothing 18mm L 110mm rotation direction left for ice-cube maker with filter		
For models:	M350, M350-Split, M800, M800-Split		
spare parts for	499232		
	Part No.	500970	Ref. No. 23073
	pump motor 55W 230V 50Hz REBO L 205mm type outlet \varnothing mm suitable for for ice maker		
	Part No.	695531	Ref. No. 10139
	supply filter thread 1" total length 100mm plastic with metal filter \varnothing 18mm		
	Part No.	695539	Ref. No. 10188 C10188
	intake valve with float		

			
1			
Part No.	500164	Ref. No.	C23254
description	pump REBO type NR40 55W 220/240V 50Hz outlet \varnothing 17mm L 113mm rotation direction left for ice-cube maker outlet upper		
For models:	IC24, IC24A-CubeA, IC30, IC30A-CubeA		

			
1			
Part No.	500161	Ref. No.	C23056 C23076
description	pump REBO type NR40 55W 230V 50Hz outlet \varnothing 17mm L 110mm rotation direction left for ice-cube maker		
For models:	CB134, CB184, FreshMaker, IC18		
spare parts for	500161		
	Part No.	500970	Ref. No. 23073
	pump motor 55W 230V 50Hz REBO L 205mm type outlet \varnothing mm suitable for for ice maker		

1

Part No.	500592	Ref. No.	C23566
description	pump REBO type NR40 55W 230V 50Hz outlet ø 17mm L 110mm rotation direction left for ice-cube maker		
For models:	VB250		



1

Part No.	500593	Ref. No.	C23607 C23624
description	pump REBO type NR40 55W 230V 50Hz outlet ø 17mm L 110mm rotation direction left for ice-cube maker		
For models:	VM350, VM500		



1

Part No.	501534	Ref. No.	C23608
description	pump REBO type NR50 60W 220/240V 50Hz outlet ø 12mm L 110mm rotation direction left		
spare parts for	501534		
	Part No.	530639	Ref. No. 10066
	impellor suitable for REBO ø 42mm ID ø 6x7mm H 17mm		



1

Part No.	500596	Ref. No.	C23626
description	pump REBO type NR50 60W 230V 50Hz outlet ø 17mm L 110mm rotation direction left for ice-cube maker		
For models:	VM900		



1

Part No.	501408	Ref. No.	23818 old version
description	pump REBO type PV35 110W 220/240V 50Hz inlet ø 20mm outlet ø 26mm L 205mm for ice-cube maker capacitor 2µF with temperature protection		
For models:	VM1700		



1

Part No.	500970	Ref. No.	23073
description	pump motor 55W 230V 50Hz REBO L 205mm type outlet ømm suitable for for ice maker		
For models:	CB134, CB184, FreshMaker, IC18, IC24, IC30, M1500, M1500-Split, M350, M350-Split, M600, M600-Split, M800, M800-Split, VB250, VM350, VM500, VM900		



1

Part No.	499117	Ref. No.	23600 N23600
description	pump motor 60W 220/240V 50Hz connection male faston 6.3mm REBO L 81mm W 63mm H 210mm shaft ø 6/7mm shaft length 104mm type outlet ømm		
For models:	M1500, M1500-Split, M2000, M2000-Split, SL260, VM900		

condensators & interference suppression filters

filters

RC circuits



1

Part No.	365211	Ref. No.	C23457
description	interference suppression filter type XRY RC MKPX2 275V connection plug		
For models:	C80, CB1265, CB184, CB246, CB249, CB316, CB416, CB425, CB640, CB840, CB955, DSS42, G1000, G1000-Split, G150, G250, G500, G500-Split, GB1540, GB1555, GB902, GB903, IceWater45, IF26, IF29, IF30, IF55, IF75, IMF28, IMF35, IMF58, IMF80, TB1405, TB852, VB250, VM350		



equipment-specific units

for potato peelers

lids



1

Part No.	696727	Ref. No.	18116
description	lid ø 310mm ID ø 275mm H 60mm mounting distance 90mm plastic		
For models:	GB1540, GB1555, GB902		

for ice-cube maker

drain systems

drain fittings



1

Part No.	695620	Ref. No.	10472
description	drain fitting straight connection 24mm for ice maker		
For models:	C150, C80, CB1265, CB134, CB1565, CB184, CB246, CB249, CB316, CB416, CB425, CB640, CB840, CB955, DSS42, FreshMaker, GB1540, GB1555, GB902, GB903, IC18, IC24, IC30, IceWater45, IF26, IF29, IF30, IF55, IF75, IMF28, IMF35, IMF58, IMF80, TB1405, TB852, VB250, VM1700		



1

Part No.	695039	Ref. No.	10471
description	drain fitting thread M30x2 L 40.7mm straight connection 17mm for ice-cube maker		
For models:	C300, CB1265, CB1565, CB640, CB840, CB955, ID70, ID70-Plus, VM350, VM500, VM900		

overflow pipes







1

Part No.	695622	Ref. No.	10305
description	lid for overflow pipe tube ø 34mm		
For models:	C150, C300, C80, CB1265, CB1565, CB246, CB249, CB316, CB416, CB425, CB640, CB840, CB955, DSS42, IC24, IC30, IceWater45, VB250, VM1700, VM900		
accessories for	695622		
	Part No.	695086	Ref. No. 10133 20233+10133
overflow pipe tube ø 20.5mm pipe length 88.6mm			

1

Part No.	695083	Ref. No.	13028
description	overflow pipe ID ø 22mm D1 ø 27mm D2 ø 19mm L 144mm		
For models:	CB134, CB184, FreshMaker, IC18, IceWater45		

1

Part No.	695086	Ref. No.	10133 20233+10133
description	overflow pipe tube ø 20.5mm pipe length 88.6mm		
For models:	C150, C300, C80, CB1265, CB1565, CB246, CB249, CB316, CB416, CB425, CB640, CB840, CB955, DSS42, IC24, IC30, IceWater45, VB250, VM350, VM500		
accessories for	695086		
	Part No.	532517	Ref. No. 20233
O-ring silicone thickness 1.78mm ID ø 17.17mm Qty 1 pcs			
	Part No.	695059	Ref. No. 10007
hose connector for ice-cube maker			
	Part No.	695537	Ref. No. 13006
gasket silicone ED ø 40mm ID ø 30mm thickness 2mm Qty 1 pcs			
	Part No.	695622	Ref. No. 10305
lid for overflow pipe tube ø 34mm			

ice breakers

1

Part No.	750216	Ref. No.	20440
description	ice breaker		
For models:	GB1540, GB1555, GB902		

1

Part No.	698899	Ref. No.	20626
description	ice breaker H 65mm ID ø 22mm ED ø 69mm hole ø 6mm seat ø 42mm		
For models:	G150, GB1540, GB1555, GB902, GB903		



ice chutes

slide grates

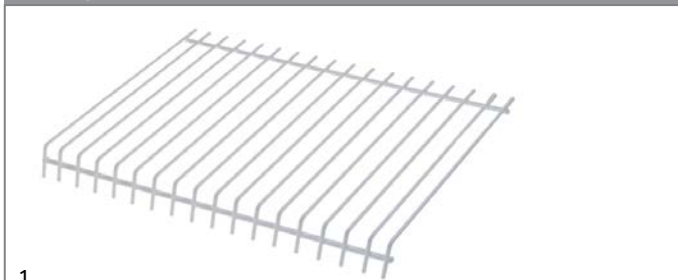

1

Part No.	694281	Ref. No.	D12001
description	slide grate for ice-cube maker L 325mm W 210mm		
For models:	CB246, CB246-CubeA, CB249, IC24, IC24A-CubeA		

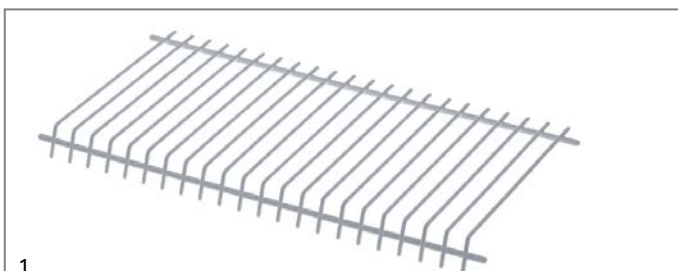

1

Part No.	692769	Ref. No.	D12008
description	slide grate for ice-cube type A L 435mm W 207mm H 26mm		
For models:	CB316, CB316-CubeA, CB416, CB425, CB425-CubeA, IC30, IC30A-CubeA, IceWater45		

spare parts and accessories



1

Part No.	699154	Ref. No.	20808 N20808
description	bush D1 ø 14mm ID ø 5/10mm H 7mm		
For models:	IFT65, IMF28, IMF35, IMF58, IMF80		

filters



1

Part No.	694878	Ref. No.	18106
description	filter L 230mm W 190mm thickness 1mm		
For models:	CB1265, CB1265-CubeA, CB246, CB246-CubeA, CB249, CB316, CB316-CubeA, CB416, CB425, CB425-CubeA, CB640, CB640-CubeA, CB840, CB955, CB955-CubeA, FB802, GB1540, GB1555, GB902, GB903, IC18, IC24, IC30, IceWater45, IF26, IF29, IF30, IF55, IF75, IMF28, IMF35, IMF58, IMF80, TB1405, TB852, VB250		

reducing rings



1

Part No.	699157	Ref. No.	20785
description	reduction ring ED ø 54mm int. ø 1 42mm int. ø 2 34mm H 30mm		
For models:	G150, GB1540, GB1555, GB902, GB903, TB1405, TB852		

spray systems

BREMA

spray arms

1

Part No.	695593	Ref. No.	C20585
description	spray arm		
For models:	VM350		



1

Part No.	695481	Ref. No.	C20147
description	spray arm L 202mm nozzles 5 for ice-cube type D		
For models:	CB134, CB184, FreshMaker, IC18		



1

Part No.	695484	Ref. No.	C20530
description	spray arm L 330mm nozzles 5 for ice-cube type C		
For models:	CB246, CB249		





			
1			
Part No.	695483	Ref. No.	C20028
description	spray arm L 330mm nozzles 6 for ice-cube type A		
For models:	CB246, CB246-CubeA, CB249		

			
1			
Part No.	695498	Ref. No.	C20572
description	spray arm L 330mm nozzles 6 for ice-cube type M		
For models:	IC24		

			
1			
Part No.	695482	Ref. No.	C20289
description	spray arm L 330mm nozzles 8 for ice-cube type D		
For models:	CB246, CB249		

			
1			
Part No.	695497	Ref. No.	C20570
description	spray arm L 330mm nozzles 8 for ice-cube type S		
For models:	IC24		



			
1			
Part No.	695503	Ref. No.	C20653
description	spray arm L 380mm nozzles 5 for ice-cube type A		
For models:	VM350		

			
1			
Part No.	695485	Ref. No.	C20189
description	spray arm L 440mm nozzles 11 for ice-cube type D		
For models:	CB316, CB416, CB425, DSS42, DSS42-CubeD, IceWater45		

			
1			
Part No.	695499	Ref. No.	C20571
description	spray arm L 440mm nozzles 11 for ice-cube type S		
For models:	IC30		

			
1			
Part No.	695487	Ref. No.	C20155
description	spray arm L 440mm nozzles 7 for ice-cube type C		
For models:	CB316, CB416, CB425, IceWater45		

			
1			
Part No.	695501	Ref. No.	C20582
description	spray arm L 440mm nozzles 7 for ice-cube type G		
For models:	IC30		

			
1			
Part No.	695486	Ref. No.	C20029
description	spray arm L 440mm nozzles 9 for ice-cube type A		
For models:	CB316, CB316-CubeA, CB416, CB425, CB425-CubeA, IceWater45		
spare parts for	695486		
	Part No.	695069	Ref. No. D20002
	spray nozzle for ice maker		







			
1			
Part No.	695500	Ref. No.	C20573
description	spray arm L 440mm nozzles 9 for ice-cube type M		
For models:	IC30		

			
1			
Part No.	695504	Ref. No.	C20617
description	spray arm L 550mm nozzles 12 for ice-cube type A		
For models:	VM1700, VM900		

			
1			
Part No.	695502	Ref. No.	C20465
description	spray arm L 550mm nozzles 7 for ice-cube type A		
For models:	VB250, VM500		

			
1			
Part No.	695490	Ref. No.	C20156
description	spray arm L 670mm nozzles 11 for ice-cube type C		
For models:	CB640, CB840, CB955		

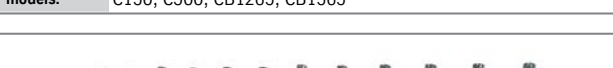

			
1			
Part No.	695489	Ref. No.	C20058
description	spray arm L 670mm nozzles 15 for ice-cube type A		
For models:	CB640, CB640-CubeA, CB840, CB955, CB955-CubeA		
			
1			
Part No.	695488	Ref. No.	C20190
description	spray arm L 670mm nozzles 18 for ice-cube type D		
For models:	CB640, CB840, CB955		
			
1			
Part No.	695493	Ref. No.	C20157
description	spray arm L 718mm nozzles 14 for ice-cube type C/E		
For models:	C150, C300, CB1265, CB1565		
			
1			
Part No.	695492	Ref. No.	C20144
description	spray arm L 718mm nozzles 18 for ice-cube type A with caps		
For models:	C150, C150-CubeA, C300, C300-CubeA, CB1265, CB1265-CubeA, CB1565, CB1565-CubeA		
			
1			
Part No.	695491	Ref. No.	C20200
description	spray arm L 718mm nozzles 20 for ice-cube type D		
For models:	C150, C300, CB1265, CB1565		
			
1			
Part No.	695496	Ref. No.	C20460
description	spray arm L 785mm nozzles 14 for ice-cube type C		
For models:	C80		
			
1			
Part No.	695495	Ref. No.	C20459
description	spray arm L 785mm nozzles 18 for ice-cube type A		
For models:	C80, C80-CubeA		
			
1			
Part No.	695494	Ref. No.	C20461
description	spray arm L 785mm nozzles 21 for ice-cube type D		
For models:	C80		

accessories			
			
1			
Part No.	695518	Ref. No.	10012
description	end cap for ice maker insertion size 16x16mm		
For models:	C150, C150-CubeA, C300, C300-CubeA, C80, C80-CubeA, CB1265, CB1265-CubeA, CB134, CB1565, CB1565-CubeA, CB184, CB246, CB246-CubeA, CB249, CB316, CB316-CubeA, CB416, CB425, CB425-CubeA, CB640, CB640-CubeA, CB840, CB955, CB955-CubeA, DSS42, DSS42-CubeD, FreshMaker, IC18, IC24, IC24A-CubeA, IC30, IC30A-CubeA, IceWater45, VB250, VM1700, VM350, VM500, VM900		

			
1			
Part No.	695069	Ref. No.	D20002
description	spray nozzle for ice maker		
For models:	C150, C150-CubeA, C300, C300-CubeA, C80, C80-CubeA, CB1265, CB1265-CubeA, CB134, CB1565, CB1565-CubeA, CB184, CB246, CB246-CubeA, CB249, CB316, CB316-CubeA, CB416, CB425, CB425-CubeA, CB640, CB640-CubeA, CB840, CB955, CB955-CubeA, DSS42, DSS42-CubeD, FreshMaker, IC18, IC24, IC24A-CubeA, IC30, IC30A-CubeA, IceWater45, VB250, VM350, VM500		

doors			
bolts			
			
1			
Part No.	694880	Ref. No.	10269
description	door bolt ED \varnothing 8mm ID \varnothing 3mm L 51.5mm		
For models:	CB1265, CB1565, CB246, CB249, CB316, CB416, CB425, CB640, CB840, CB955, GB1540, GB1555, GB902, IC30		

doors			
			
1			
Part No.	695510	Ref. No.	10103
description	door for ice-cube maker W 293mm H 182mm thickness 24mm		
For models:	CB134, CB184		



1

Part No.	695511	Ref. No.	10277
description	door for ice-cube maker W 293mm H 182mm thickness 25mm		
For models:	CB184, FreshMaker		



1

Part No.	695512	Ref. No.	10081
description	door for ice-cube maker W 293mm H 182mm thickness 25mm		
For models:	CB184, IC18		



1

Part No.	695513	Ref. No.	C10303
description	door for ice-cube maker W 337mm H 207mm thickness 22mm		
For models:	CB246, CB246-CubeA, CB249, IC24, IC24A-CubeA, IF26, IF29, IMF28		



1

Part No.	695516	Ref. No.	C22347
description	door for ice-cube maker W 445mm H 235mm thickness 22mm		
For models:	DSS42-CubeD		



1

Part No.	695514	Ref. No.	C10297
description	door for ice-cube maker W 447mm H 217mm thickness 22mm		
For models:	CB316, CB316-CubeA, CB416, CB425, CB425-CubeA, GB902, GB903, IC30, IC30A-CubeA, IceWater45, IF30, IF55, IMF35, IMF58, TB852		



1

Part No.	695515	Ref. No.	C10275
description	door for ice-cube maker W 675mm H 307mm thickness 28mm		
For models:	CB1265, CB1265-CubeA, CB1565, CB1565-CubeA, CB640, CB640-CubeA, CB840, CB955, CB955-CubeA, GB1540, GB1555, IF75, IMF80, TB1405, VB250		

curtains

with holder



1

Part No.	695356	Ref. No.	C22106
description	curtain for ice maker W 275mm H 140mm with holder shaft length 275mm shaft ø 7.5mm		
For models:	CB134, CB184, FreshMaker, IC18		



1

Part No.	695506	Ref. No.	C22034 K10533
description	curtain for ice maker W 328mm H 150mm with holder shaft length 325mm shaft ø 7.5mm		
For models:	CB246, CB246-CubeA, CB249, IC24, IC24A-CubeA		



			
1			
Part No.	695507	Ref. No.	C22035
description	curtain for ice maker W 433mm H 165mm with holder shaft length 438mm shaft ø 7.5mm		
For models:	CB316, CB316-CubeA, CB416, CB425, CB425-CubeA, DSS42, DSS42-CubeD, IC30, IC30A-CubeA, IceWater45		

			
1			
Part No.	696595	Ref. No.	K10534
description	curtain for ice maker W 433mm H 165mm with holder shaft length 438mm shaft ø 7.5mm		

			
1			
Part No.	695508	Ref. No.	C22059
description	curtain for ice maker W 660mm H 165mm with holder shaft length 665mm shaft ø 7.5mm		
For models:	CB640, CB640-CubeA, CB840, CB955, CB955-CubeA		

			
1			
Part No.	695509	Ref. No.	C22134
description	curtain for ice maker W 720mm H 190mm with holder shaft length 715mm shaft ø 7.5mm		
For models:	C150, C150-CubeA, C300, C300-CubeA, CB1265, CB1265-CubeA, CB1565, CB1565-CubeA		

			
1			
Part No.	696594	Ref. No.	K10532
description	curtain for ice-cube maker W 273mm H 160mm shaft length 280mm shaft ø 7.6mm holder length 316mm		

without holder

			
1			
Part No.	695619	Ref. No.	C10532
description	curtain for ice maker W 275mm H 80mm shaft length 280mm shaft ø 7.5mm		
For models:	CB134, CB184, FreshMaker, IC18		

			
1			
Part No.	695116	Ref. No.	C10533
description	curtain for ice-cube maker W 320mm H 80mm shaft length 325mm shaft ø 7.5mm		
For models:	CB246, CB249, IC24		

			
1			
Part No.	695117	Ref. No.	C10534
description	curtain for ice-cube maker W 430mm H 80mm shaft length 440mm shaft ø 7.5mm complete with rod		
For models:	CB316, CB416, CB425, DSS42, IC30, IceWater45		

accessories

holders

			
1			
Part No.	696754	Ref. No.	10526
description	curtain holder for ice maker W 107mm H 35mm suitable for CB316-416-425		
For models:	CB316, CB416, CB425, DSS42, IC30, IceWater45		

lamellas

			
1			
Part No.	695082	Ref. No.	10005
description	lamella for curtain L 69mm W 23mm ID ø 8mm		
For models:	C150, C300, C80, CB1265, CB1565, CB184, CB246, CB249, CB316, CB416, CB425, CB640, CB840, CB955, DSS42, FreshMaker, IC18, IC24, IC24A-CubeA, IC30, IC30A-CubeA, IceWater45		

pan mechanics

sumps

			
1			
Part No.	695573	Ref. No.	C22285
description	drain tray L 200mm W 120mm H 60mm		
For models:	IF26, IF29		



1

Part No.	695591	Ref. No.	C22356
description	drain tray L 290mm W 180mm H 75mm		
For models:	IF55		



1

Part No.	694439	Ref. No.	C10484
description	sump complete for ice-cube maker L 227mm W 175mm H 100mm		
For models:	IMF28		



1

Part No.	695517	Ref. No.	C22256
description	sump for ice maker L 290mm W 175mm H 75mm		
For models:	IF30		



1

Part No.	696739	Ref. No.	C10491 RC10491
description	sump for ice maker L 310mm W 205mm H 85mm		
For models:	IMF58		



1

Part No.	696753	Ref. No.	10355
description	sump for ice maker L 490mm W 250mm VM350 white		
For models:	VM350		

spare parts and accessories



1

Part No.	695376	Ref. No.	20227
description	adjusting ring for spindle H 7mm ID ø 6mm ED ø 12mm thread M4 stainless steel		
For models:	IF26, IF29, IF30, IF55, IF75, IMF28, IMF35, IMF58, IMF80		



1

Part No.	695542	Ref. No.	20230
description	bush for spindle ID ø 6mm		
For models:	IF26, IF29, IF30, IF55, IF75, IMF28, IMF35, IMF58, IMF80		



1

Part No.	695543	Ref. No.	20231
description	bush for sump ED ø 14mm ID ø 12.2mm		
For models:	IF26, IF29, IF30, IF55, IF75, IMF28, IMF35, IMF58, IMF80		



1

Part No.	695574	Ref. No.	22359
description	lever for microswitch		
For models:	IF55, IF75		



1

Part No.	695011	Ref. No.	20258
description	paddle with spindle		
For models:	IF26, IF29		



1

Part No.	695013	Ref. No.	20389
description	paddle with spindle		
For models:	IF75		



1

Part No.	695012	Ref. No.	20221
description	paddle with spindle ø 95mm shaft ø 6mm shaft length 350mm		
For models:	IF30, IF55		



suction system

intake filters



1

Part No.	695532	Ref. No.	20005
description	round filters ø 28mm H 60mm		
For models:	C150, C150-CubeA, C300, C300-CubeA, C80, C80-CubeA, CB1265, CB1265-CubeA, CB1565, CB1565-CubeA, CB246, CB246-CubeA, CB249, CB316, CB316-CubeA, CB416, CB425, CB425-CubeA, CB640, CB640-CubeA, CB840, CB955, CB955-CubeA, DSS42, DSS42-CubeD, IC24, IC24A-CubeA, IC30, IC30A-CubeA, IceWater45		

drive technology

gear wheels



1

Part No.	694546	Ref. No.	20494
description	coupling piece ø 70mm ID ø 30mm H 15mm		
For models:	G1000, G1000-Split, G250, G500, G500-Split		

gaskets

miscellaneous



1

Part No.	695534	Ref. No.	13143
description	gasket silicone ED ø 36mm ID ø 23.5mm thickness 3mm Qty 1 pcs		
For models:	C150, C300, C80, CB1265, CB1565, CB246, CB249, CB316, CB416, CB425, CB640, CB840, CB955, DSS42, IceWater45		



1

Part No.	695537	Ref. No.	13006	
description	gasket silicone ED ø 40mm ID ø 30mm thickness 2mm Qty 1 pcs			
For models:	C150, C300, C80, CB1265, CB134, CB1565, CB184, CB246, CB249, CB316, CB416, CB425, CB640, CB840, CB955, DSS42, FreshMaker, GB1540, GB1555, GB902, GB903, IC18, IC24, IC30, IceWater45, ID70, ID70-Plus, IF26, IF29, IF30, IF55, IF75, IMF28, IMF35, IMF58, IMF80, M2000, M2000-Split, TB1405, TB852, VB250, VM1700, VM350, VM500, VM900			
accessories for	695537			
	Part No.	695059	Ref. No.	10007
	hose connector for ice-cube maker			

housing and bezels

ventilation grilles



1

Part No.	694877	Ref. No.	C10205
description	bezel for aspiration with filter L 260mm W 22mm H 252mm mounting pos. front		
For models:	CB1265, CB1265-CubeA, CB246, CB246-CubeA, CB249, CB316, CB316-CubeA, CB416, CB425, CB425-CubeA, CB640, CB640-CubeA, CB840, CB955, CB955-CubeA, FB802, GB1540, GB1555, GB902, GB903, IceWater45, IF26, IF29, IF30, IF55, IF75, IMF28, IMF35, IMF58, IMF80, TB1405, TB852, VB250		

flaps



1

Part No.	696350	Ref. No.	C26544
description	flap W 79mm H 86mm thickness 26mm		
For models:	DSS42, DSS42-CubeD, FreshMaker, IceWater45		

mechanics for evaporators

screw conveyors



1

Part No.	698194	Ref. No.	20439
description	auger		
For models:	GB1540, GB1555, GB902		

miscellaneous



1

Part No.	750218	Ref. No.	18170
description	insulation ED ø 95mm for evaporator		
For models:	G150, GB1540, GB1555, GB902, GB903		



1

Part No.	696550	Ref. No.	20633
description	mechanical shaft seal for evaporator ID ø 26mm		
For models:	G250, G500, GB1540, GB1555, GB902, GB903		



Part No.	560513	Ref. No.	22826
description	plain washer ID ø 24mm ED ø 41.6mm thickness 2mm SS Qty 1 pcs		
For models:	G150, GB1540, GB1555, GB902, GB903		



Part No.	560514	Ref. No.	20631
description	plain washer ID ø 24mm ED ø 42mm thickness 1.5mm SS Qty 1 pcs for evaporator with hole		
For models:	G150, GB1540, GB1555, GB902, GB903		

hoses

formed hoses

straight

with collar



Part No.	530748	Ref. No.	13064
description	formed hose straight with collar for ice-cube maker ID ø 13mm ED ø 19mm L 105mm		
For models:	IF26		



Part No.	530756	Ref. No.	13057
description	formed hose straight with collar for ice-cube maker ID ø 13mm ED ø 19mm L 270mm		
For models:	IF55, IF75		



Part No.	530751	Ref. No.	13063
description	formed hose straight with collar for ice-cube maker ID ø 13mm ED ø 20mm L 185mm		
For models:	IF29		

silicone hoses



Part No.	530754	Ref. No.	13107
description	silicone hose ID ø 13mm ED ø 19mm L 0.13m t.max. 200°C for ice-cube maker		
For models:	CB1265, CB1565, CB316, CB316-CubeA, CB416, IC30, IF30, IMF58, IMF80		



Part No.	530752	Ref. No.	13106
description	silicone hose ID ø 13mm ED ø 19mm L 0.15m t.max. 200°C for ice-cube maker		
For models:	CB249, IF29, IMF80, VB250		



Part No.	530757	Ref. No.	13108
description	silicone hose ID ø 13mm ED ø 19mm L 0.24m t.max. 200°C for ice-cube maker		
For models:	CB425, CB425-CubeA, DSS42, DSS42-CubeD, IceWater45, IF55, IF75, VB250		



Part No.	530758	Ref. No.	13109
description	silicone hose ID ø 13mm ED ø 19mm L 0.26m t.max. 200°C for ice-cube maker		
For models:	CB1265-CubeA, CB1565-CubeA, CB640, CB640-CubeA, CB840		



Part No.	530759	Ref. No.	13110
description	silicone hose ID ø 13mm ED ø 19mm L 0.35m t.max. 200°C for ice-cube maker		
For models:	CB955, CB955-CubeA		



Part No.	530749	Ref. No.	13105
description	silicone hose ID ø 13mm ED ø 19mm L 0.7m t.max. 200°C for ice-cube maker		
For models:	CB246, CB246-CubeA, IC24, IF26		



Part No.	530731	Ref. No.	13056
description	silicone hose ID ø 16mm ED ø 23mm L 0.03m t.max. 200°C for ice-cube maker		
For models:	CB134, CB184, FreshMaker, IC18		



Part No.	530737	Ref. No.	13137
description	silicone hose ID ø 16mm ED ø 23mm L 0.29m t.max. 200°C for ice-cube maker		
For models:	C150, CB249, CB316, CB416		



Part No.	530738	Ref. No.	13139
description	silicone hose ID ø 16mm ED ø 23mm L 0.4m t.max. 200°C for ice-cube maker		
For models:	CB425, IceWater45		



Part No.	530739	Ref. No.	13140
description	silicone hose ID ø 16mm ED ø 23mm L 0.5m t.max. 200°C for ice-cube maker		
For models:	CB640, CB840, DSS42		



1			
Part No.	530740	Ref. No.	13141
description	silicone hose ID ø 16mm ED ø 23mm L 0.61m t.max. 200°C for ice-cube maker		
For models:	CB955		

1			
Part No.	530764	Ref. No.	13138
description	silicone hose ID ø 18mm ED ø 27mm L 0.3m t.max. 200°C for ice-cube maker		
For models:	CB316, CB416, CB425		

1			
Part No.	530734	Ref. No.	13113
description	silicone hose straight for ice-cube maker ID ø 16mm ED ø 23mm L 320mm		
For models:	VB250, VM350, VM500, VM900		

1			
Part No.	530733	Ref. No.	13111
description	silicone hose straight for ice-cube maker ID ø 16mm ED ø 23mm L 500mm		
For models:	VB250, VM1700, VM350, VM500, VM900		

1			
Part No.	530741	Ref. No.	13142
description	silicone hose straight for ice-cube maker ID ø 16mm ED ø 23mm L 645mm		
For models:	CB1265, CB1565		

1			
Part No.	530735	Ref. No.	13134
description	silicone hose straight for ice-cube maker ID ø 16mm ED ø 23mm L 700mm		
For models:	VM1700, VM350, VM500, VM900		

1			
Part No.	530736	Ref. No.	13136
description	silicone hose straight for ice-cube maker ID ø 18mm ED ø 25mm L 213mm		
For models:	C80, CB246		

form L			
1			
Part No.	530750	Ref. No.	13061
description	formed hose L-shape for ice-cube maker ID ø 14/19mm ED ø 18/22mm L 240mm W 45mm		
For models:	CB249		

1			
Part No.	530755	Ref. No.	13030
description	formed hose L-shape for ice-cube maker ID ø 15/19mm ED ø 20/23mm L 330mm W 70mm		
For models:	CB425, CB425-CubeA, DSS42, DSS42-CubeD, IceWater45		

1			
Part No.	695107	Ref. No.	13005
description	formed hose L-shape for ice-cube maker ID ø 17mm ED ø 23.5mm L 70mm W 50mm		
For models:	C80, C80-CubeA, CB246, CB246-CubeA, CB249, CB316, CB316-CubeA, CB416, CB425, CB425-CubeA, CB640, CB640-CubeA, CB840, CB955, CB955-CubeA, DSS42, DSS42-CubeD, IceWater45, VM1700, VM350, VM500, VM900		

1			
Part No.	530742	Ref. No.	13046
description	formed hose L-shape for ice-cube maker ID ø 18mm ED ø 25mm L 170mm W 80mm		
For models:	C300, C300-CubeA		

1			
Part No.	530732	Ref. No.	13055
description	silicone hose L-shape for ice-cube maker ID ø 17mm ED ø 24mm L 120mm W 50mm		
For models:	CB134, CB184, FreshMaker, IC18		

form S			
1			
Part No.	530761	Ref. No.	13150
description	formed hose S-shape for ice-cube maker ID ø 18mm ED ø 28mm L 95mm W 55mm		
For models:	C300		

1			
Part No.	530760	Ref. No.	13067
description	formed hose S-shape for ice-cube maker ID ø 22mm ED ø 28mm L 315mm W 80mm		
For models:	C300, IC30, IC30A-CubeA		



form U

group 1



Part No.	530747	Ref. No.	13058
description	formed hose U-shape for ice-cube maker ID ø 17/23mm ED ø 25/31mm L 610mm W 120mm		
For models:	CB955, CB955-CubeA		



Part No.	530745	Ref. No.	13062
description	formed hose U-shape for ice-cube maker ID ø 17/25mm ED ø 25/31mm L 300mm W 90mm		
For models:	CB249		



Part No.	695104	Ref. No.	13095
description	formed hose U-shape for ice-cube maker ID ø 17/25mm ED ø 25/32mm L 425mm W 125mm		
For models:	CB1265, CB1265-CubeA, CB1565, CB1565-CubeA		

group 2



Part No.	695099	Ref. No.	13021
description	formed hose U-shape for ice-cube maker ID ø 17/26mm ED ø 25/32mm L 460mm W 100mm		
For models:	CB425, CB425-CubeA, IceWater45		



Part No.	695097	Ref. No.	13003
description	formed hose U-shape for ice-cube maker ID ø 18/26mm ED ø 25/31mm L 280mm W 75mm		
For models:	C80, C80-CubeA, CB246, CB246-CubeA		



Part No.	695100	Ref. No.	13015
description	formed hose U-shape for ice-cube maker ID ø 18/26mm ED ø 25/32mm L 560mm W 90mm		
For models:	CB640, CB640-CubeA, CB840, DSS42, DSS42-CubeD		



Part No.	530746	Ref. No.	13059
description	formed hose U-shape for ice-cube maker ID ø 18/27mm ED ø 25/32mm L 670mm W 90mm		
For models:	CB955, CB955-CubeA, VM1700		



Part No.	695101	Ref. No.	13096
description	formed hose U-shape for ice-cube maker ID ø 18/27mm ED ø 25/32mm L 700mm W 100mm		
For models:	CB1265, CB1265-CubeA, CB1565, CB1565-CubeA		

miscellaneous



Part No.	530744	Ref. No.	13068
description	formed hose for ice-cube maker ID ø 15mm ED ø 23mm L 180mm W 95mm		
For models:	IC24, IC24A-CubeA, IC30, IC30A-CubeA		



Part No.	695528	Ref. No.	C13036
description	hose set for spray arm		
For models:	C300, C300-CubeA, CB1265, CB1265-CubeA, CB1565, CB1565-CubeA		





Part No.	695529	Ref. No.	C13037
description	hose set for spray arm		
For models:	C150, C150-CubeA		



			
1			
Part No.	695530	Ref. No.	C13101
description	hose set for spray arm		
For models:	C80, C80-CubeA		

hose connectors

with thread

							
1							
Part No.	695059	Ref. No.	10007				
description	hose connector for ice-cube maker						
For models:	C150, C150-CubeA, C300, C300-CubeA, C80, C80-CubeA, CB1265, CB1265-CubeA, CB1565, CB1565-CubeA, CB184, CB246, CB246-CubeA, CB249, CB316, CB316-CubeA, CB416, CB425, CB425-CubeA, CB640, CB640-CubeA, CB840, CB955, CB955-CubeA, DSS42, DSS42-CubeD, FB802, FreshMaker, GB1540, GB1555, GB902, IC18, IC24, IC24A-CubeA, IC30, IC30A-CubeA, IceWater45, IF26, IF29, IF30, IF55, IF75, VB250						
accessories for	695059						
		<table border="1"> <tr> <td>Part No.</td> <td>695537</td> <td>Ref. No.</td> <td>13006</td> </tr> </table>	Part No.	695537	Ref. No.	13006	
Part No.	695537	Ref. No.	13006				
	gasket silicone ED ø 40mm ID ø 30mm thickness 2mm Qty 1 pcs						

without thread

			
1			
Part No.	695540	Ref. No.	C10415
description	hose connector 1-way for hose for ice-cube maker		
For models:	C300		

			
1			
Part No.	695058	Ref. No.	10006
description	hose connector 2-way for ice-cube maker		
For models:	C300, IC18, IC24, IC24A-CubeA, IC30, IC30A-CubeA		

			
1			
Part No.	695521	Ref. No.	10431
description	hose connector 2-way for ice-cube maker		
For models:	VM1700, VM350, VM500, VM900		

			
1			
Part No.	695519	Ref. No.	C26453
description	hose connector 3-way for hose for ice-cube maker		
For models:	FB802, IceWater45		

			
1			
Part No.	695520	Ref. No.	C26454
description	hose connector 3-way for hose for ice-cube maker		
For models:	FB802, IceWater45		

			
1			
Part No.	695525	Ref. No.	C10235
description	hose connector 3-way for hose for ice-cube maker		
For models:	GB1540, GB1555, GB902, GB903, TB1405, TB852		

			
1			
Part No.	695526	Ref. No.	C10240
description	hose connector 3-way for hose for ice-cube maker		
For models:	GB1540, GB1555, GB902, GB903, TB1405, TB852		

			
1			
Part No.	695527	Ref. No.	C26452
description	hose connector 3-way for hose for ice-cube maker		
For models:	C150, C150-CubeA, C80, C80-CubeA, CB1265, CB1265-CubeA, CB1565, CB1565-CubeA, CB184, CB246, CB246-CubeA, CB249, CB316, CB316-CubeA, CB416, CB425, CB425-CubeA, CB640, CB640-CubeA, CB840, CB955, CB955-CubeA, DSS42, DSS42-CubeD, IF26, IF29, IF30, IF55, IF75, IMF28, IMF35, IMF58, IMF80, VB250		

			
1			
Part No.	695541	Ref. No.	C10121
description	hose connector 3-way for hose for ice-cube maker		
For models:	FreshMaker		



1

Part No.	695522	Ref. No.	10579 C10052
description	hose connector 3-way for ice-cube maker		
For models:	F230, G150, G250, G500, G500-Split, M350, M800, VM500, VM900		



1

Part No.	695523	Ref. No.	C10053
description	hose connector 3-way for ice-cube maker		
For models:	F230, G150, G250, G500, M350, M800, VM500, VM900		



1

Part No.	695524	Ref. No.	C10384
description	hose connector 3-way for ice-cube maker		
For models:	G1000, G1000-Split, M1500, M1500-Split, M350, M350-Split, M600, M600-Split, M800, M800-Split		

miscellaneous

1

Part No.	530763	Ref. No.	13133
description	formed hose for ice-cube maker		
For models:	C300		

floats

float containers



1

Part No.	695072	Ref. No.	C10164 C10201
description	float container for ice maker with microswitch plastic		
For models:	F230, FB802, G250		



1

Part No.	696755	Ref. No.	C10164GB C10704	
description	float container for ice maker with microswitch plastic suitable for GB902			
For models:	GB1540, GB1555, GB902, GB903, TB852			
spare parts for	696755			
	Part No.	345105	Ref. No.	23055
	microswitch with plunger 250V 16A 1CO connection male faston 6.3mm L 28mm ambient temperature max. 125°C mounting distance 22mm type SM-51 actuating force: 280g black			

1

Part No.	402163	Ref. No.	10145	
description	float container L 150mm 250V cable lengthmm ømm mounting ømm 2CO 12A male faston 6.3mm			
For models:	G1000, G1000-Split, G150, G250, G500, G500-Split, GB1540, GB1555, GB902, GB903, TB1405, TB852			
spare parts for	402163			
	Part No.	348044	Ref. No.	—
	microswitch with plunger 250V 16A 1CO connection male faston 4.8mm Lmm L1 27.8mm ambient temperature max. 125°C mounting distance 22mm with lever set type MS1-16 actuating force: 45g white			

1

Part No.	694879	Ref. No.	10707 C10200GB C10707
description	float container L 150mm W 80mm H 130mm with switch		
For models:	GB1555, TB1405		

miscellaneous





1

Part No.	696351	Ref. No.	22402
description	bracket for jar		
For models:	DSS42, DSS42-CubeD		





			
1			
Part No.	695431	Ref. No.	20280
description	bush for auger L 43mm ø 20mm		
For models:	DSS42, DSS42-CubeD		

			
1			
Part No.	695533	Ref. No.	10404
description	butt splice connector thread M23x1.5 for hose ID 18mm		
For models:	C150, C80, CB1265, CB1565, CB246, CB249, CB316, CB416, CB425, CB640, CB840, CB955, DSS42, IceWater45		

			
1			
Part No.	695536	Ref. No.	10096
description	nut for drain assembly		
For models:	C150, C300, C80, CB1265, CB134, CB1565, CB184, CB246, CB249, CB316, CB416, CB425, CB640, CB840, CB955, DSS42, FreshMaker, GB1540, GB1555, GB902, GB903, IC18, IC24, IC30, IceWater45, ID70, ID70-Plus, IF26, IF29, IF30, IF55, IF75, IMF28, IMF35, IMF58, IMF80, TB1405, TB852, VB250, VM1700, VM350, VM500, VM900		

			
1			
Part No.	695535	Ref. No.	10405
description	nut for ice-cube maker thread M23x1.5		
For models:	C150, C300, C80, CB1265, CB1565, CB246, CB249, CB316, CB416, CB425, CB640, CB840, CB955, DSS42, IceWater45		

			
1			
Part No.	695430	Ref. No.	20281
description	screw conveyor for ice-cube maker L 340mm ø 78mm thread L 8mm		
For models:	DSS42, DSS42-CubeD		

valves			
intake valves			
			
1			
Part No.	695539	Ref. No.	10188 C10188
description	intake valve with float		
For models:	M1500, M1500-Split, M2000, M2000-Split, M350, M350-Split, M600, M600-Split, M800, M800-Split, VM500, VM900		

equipment feet and end caps

equipment feet

with screw mounting

			
1			
Part No.	700761	Ref. No.	20613
description	equipment foot tube ø 50mm thread M10 thread L 12mm H 130-180mm SS size 2" Qty 1 pcs		
For models:	CB1265, CB1565, CB316, CB416, CB425, CB640, CB840, CB955, DSS42, GB1540, GB1555, GB902, GB903, IceWater45, IF30, IF55, IF75, IMF35, IMF58, IMF80, TB1405, TB852, VB250		

screw-in feet

			
1			
Part No.	695353	Ref. No.	10017
description	equipment foot thread L 17mm ø 18mm H 40mm WS 24 Qty 1 pcs		
For models:	CB134, CB184, CB246, CB246-CubeA, CB249, FreshMaker, IC18, IC24, IC24A-CubeA, IC30, IC30A-CubeA, IF26, IF29, IMF28		

gaskets

O-rings

EPDM

			
1			
Part No.	528339	Ref. No.	20429
description	O-ring EPDM thickness 2.62mm ID ø 40.95mm Qty 1 pcs		
For models:	G150, GB1540, GB1555, GB902, GB903, TB1405, TB852		

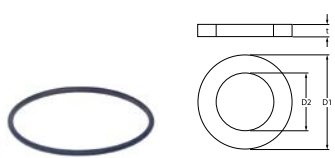
			
1			
Part No.	532534	Ref. No.	20931
description	O-ring EPDM thickness 3.53mm ID ø 82.14mm Qty 1 pcs		
For models:	TB1405, TB852		



silicone

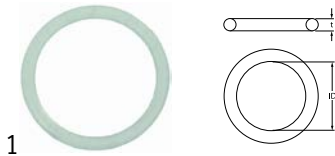

Part No.	532517	Ref. No.	20233
description	O-ring silicone thickness 1.78mm ID \varnothing 17.17mm Qty 1 pcs		
For models:	C150, C300, C80, CB1265, CB1565, CB246, CB249, CB316, CB416, CB425, CB640, CB840, CB955, DSS42, IC24, IC30, IceWater45, VB250, VM350, VM500, VM900		

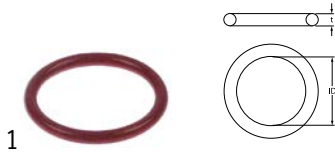

Part No.	532568	Ref. No.	20688
description	O-ring silicone thickness 2.62mm ID \varnothing 21.89mm Qty 1 pcs		
For models:	G150, GB1540, GB1555, GB902, GB903		

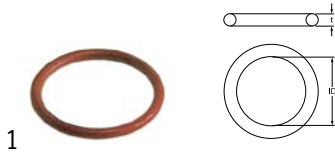

Part No.	532307	Ref. No.	20338
description	O-ring silicone thickness 3.53mm ID \varnothing 20.22mm Qty 10 pcs		
For models:	M1500, M1500-Split, M350, M350-Split, M600, M600-Split, M800, M800-Split		

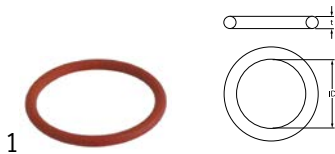

Part No.	527123	Ref. No.	20689
description	O-ring silicone thickness 3.53mm ID \varnothing 34.52mm Qty 1 pcs		
For models:	G1000, G1000-Split, G250, G500, G500-Split		

NBR

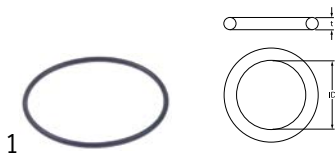

Part No.	532655	Ref. No.	20205
description	O-ring NBR thickness 3.53mm ID \varnothing 78.97mm Qty 1 pcs		
For models:	G1000, G1000-Split, G500, G500-Split		

sealing washers

plastic gaskets



Part No.	695538	Ref. No.	13007
description	gasket plastic ED \varnothing 40mm ID \varnothing 30mm thickness 2mm Qty 1 pcs		
For models:	C150, C300, C80, CB1265, CB134, CB1565, CB184, CB246, CB249, CB316, CB416, CB425, CB640, CB840, CB955, DSS42, FreshMaker, GB1540, GB1555, GB902, GB903, IC18, IC24, IC30, IceWater45, ID70, ID70-Plus, IF26, IF29, IF30, IF55, IF75, IMF28, IMF35, IMF58, IMF80, TB1405, TB852, VB250, VM1700, VM350, VM500, VM900		

silicone gaskets



Part No.	695534	Ref. No.	13143
description	gasket silicone ED \varnothing 36mm ID \varnothing 23.5mm thickness 3mm Qty 1 pcs		
For models:	C150, C300, C80, CB1265, CB1565, CB246, CB249, CB316, CB416, CB425, CB640, CB840, CB955, DSS42, IceWater45		



Part No.	695537	Ref. No.	13006
description	gasket silicone ED \varnothing 40mm ID \varnothing 30mm thickness 2mm Qty 1 pcs		
For models:	C150, C300, C80, CB1265, CB134, CB1565, CB184, CB246, CB249, CB316, CB416, CB425, CB640, CB840, CB955, DSS42, FreshMaker, GB1540, GB1555, GB902, GB903, IC18, IC24, IC30, IceWater45, ID70, ID70-Plus, IF26, IF29, IF30, IF55, IF75, IMF28, IMF35, IMF58, IMF80, M2000, M2000-Split, TB1405, TB852, VB250, VM1700, VM350, VM500, VM900		
accessories for	695537		
	Part No.	695059	Ref. No. 10007
	hose connector for ice-cube maker		

shaft gaskets

shaft gaskets



Part No.	696721	Ref. No.	20937
description	shaft sealing ID \varnothing 26mm ED \varnothing 39.2mm thickness 9.4mm H 38.5mm		
For models:	G150, GB1540, GB1555, GB902, GB903, TB1405, TB852		



refrigeration cycle components

cooling water regulators

JOHNSON CONTROLS



1

Part No.	541190	Ref. No.	20149
description	cooling water regulator 3/8" type V46AA-9606 connection 7/16" UNF (1/4" SAE) pressure range 5-23bar water pressure max. 10bar water temperature max. 90°C capillary pipe 750mm L 160mm 0.9kg		
For models:	C300, C300-CubeA, G1000, M350, M800, VM900		



1

Part No.	541186	Ref. No.	20210
description	cooling water regulator 3/8" type V46SA-9951 connection 6mm soldering connection pressure range 5-23bar water pressure max. 18bar water temperature max. 90°C capillary pipe 750mm L 101mm		
For models:	C150, C150-CubeA, CB1565, CB1565-CubeA, F230, G250, G500, VM500		

valves

Schrader valves

valve bodies



1

Part No.	750097	Ref. No.	14007
description	valve body for Schrader valve thread 1/4" SAE connection 6mm soldering connection		
For models:	C150, C150-CubeA, C300, C80, C80-CubeA, CB1265, CB1265-CubeA, CB134, CB1565, CB1565-CubeA, CB184, CB246, CB246-CubeA, CB249, CB316, CB316-CubeA, CB416, CB425, CB425-CubeA, CB640, CB640-CubeA, CB840, CB955, CB955-CubeA, DSS42, DSS42-CubeD, F230, FB802, FreshMaker, G1000, G150, G250, G500, GB1540, GB1555, GB902, GB903, IC18, IC24, IC24A-CubeA, IC30, IC30A-CubeA, IceWater45, IF26, IF29, IF30, IF55, IF75, IMF28, IMF35...(Other models you can see in the webshop)		

valve inserts



1

Part No.	750098	Ref. No.	14005
description	Schrader valve CASTEL 8394/B R22		
For models:	C150, C150-CubeA, C300, C80, C80-CubeA, CB1265, CB1265-CubeA, CB134, CB1565, CB1565-CubeA, CB184, CB246, CB246-CubeA, CB249, CB316, CB316-CubeA, CB416, CB425, CB425-CubeA, CB640, CB640-CubeA, CB840, CB955, CB955-CubeA, DSS42, DSS42-CubeD, F230, FB802, FreshMaker, G1000, G150, G250, G500, GB1540, GB1555, GB902, GB903, IC18, IC24, IC24A-CubeA, IC30, IC30A-CubeA, IceWater45, IF26, IF29, IF30, IF55, IF75, IMF28, IMF35...(Other models you can see in the webshop)		

filter driers

CASTEL

STANDARD series

suitable for refrigerants R12, R22, R134a, R404A, R407C, R410A, R502, R507

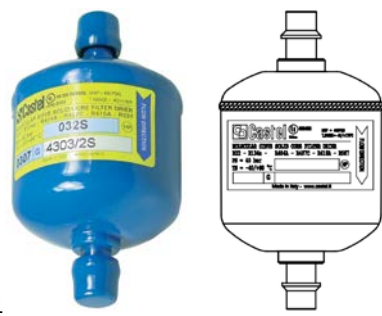

1

Part No.	750038	Ref. No.	14089
description	dryer type 4303/2S connection ODS 1/4"-ODM 3/8" 50cm ³ p max 45bar -40 up to +80°C		
For models:	C80, C80-CubeA, CB1265, CB1265-CubeA, CB640, CB640-CubeA, CB840, CB955, CB955-CubeA, F230, G250, G500, IF75, IMF80, VB250		



1

Part No.	750039	Ref. No.	14084
description	dryer type 4305/2S connection ODS 1/4"-ODM 3/8" 80cm ³ p max 45bar -40 up to +80°C 254g		
For models:	C150, C150-CubeA, C300, C300-CubeA, CB1565, CB1565-CubeA, G500, M350, M600, VM350, VM500, VM900		

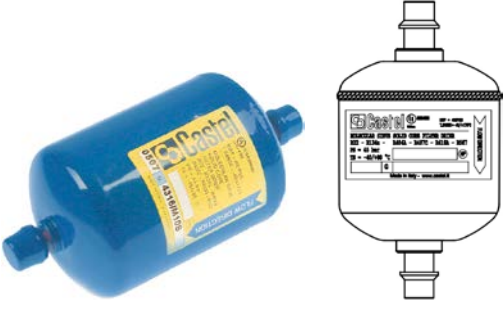
1

Part No.	750074	Ref. No.	14255
description	dryer type 4316/M105 connection ODS 10mm 250cm ³		
For models:	G1000, M1500, M2000, M800, VM1700		

miscellaneous



1

Part No.	750075	Ref. No.	14009
description	dryer size 12g ø 16mm L 120mm connection 3/6,3mm		
For models:	CB134, CB184, CB246, CB246-CubeA, CB249, CB316, CB316-CubeA, CB416, CB425, CB425-CubeA, DSS42, DSS42-CubeD, FB802, FreshMaker, G150, GB1540, GB1555, GB902, GB903, IC18, IC24, IC24A-CubeA, IC30, IC30A-CubeA, IceWater45, IF26, IF29, IF30, IF55, IF75, IMF28, IMF35, IMF58, TB1405, TB852		



1

Part No.	750199	Ref. No.	D10079
description	evaporator for ice-cube maker 20 cubes L 225mm W 180mm H 40mm		
For models:	CB134, CB184, FreshMaker, IC18		



1

Part No.	750200	Ref. No.	D10045
description	evaporator for ice-cube maker 24 cubes L 320mm W 190mm H 40mm		
For models:	CB246, CB246-CubeA, CB249, IC24, IC24A-CubeA		



1

Part No.	750201	Ref. No.	D10046
description	evaporator for ice-cube maker 36 cubes L 440mm W 190mm H 40mm		
For models:	CB316, CB316-CubeA, CB416, CB425, CB425-CubeA, IC30, IC30A-CubeA, IceWater45		

evaporators

for ice-cube maker

for ice cube maker



1

Part No.	696606	Ref. No.	D10126
description	evaporator for ice-cube maker 120 cubes L 780mm W 280mm H 60mm		
For models:	C150, C300, CB1265, CB1565		



1

Part No.	750202	Ref. No.	D10047
description	evaporator for ice-cube maker 60 cubes L 665mm W 190mm H 40mm		
For models:	CB640, CB640-CubeA, CB840, CB955, CB955-CubeA		

for flake ice maker



1

Part No.	694562	Ref. No.	KITNEVG250
description	evaporator for flake ice maker G250		
For models:	G250, G500		

accessories

miscellaneous



1

Part No.	696550	Ref. No.	20633
description	mechanical shaft seal for evaporator ID ø 26mm		
For models:	G250, G500, GB1540, GB1555, GB902, GB903		



1

Part No.	692095	Ref. No.	20455
description	suppressor		
For models:	GB1540, GB1555, GB902		

condensors

condensors

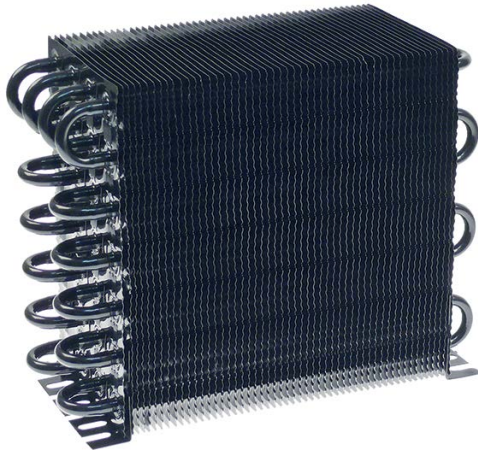

1

Part No.	750661	Ref. No.	20019
description	condenser W 215mm D 270mm H 117mm Qty 1 pcs		
For models:	CB416, CB425, CB425-CubeA, DSS42, DSS42-CubeD, GB1540, GB1555, IceWater45, IF55, IMF58		

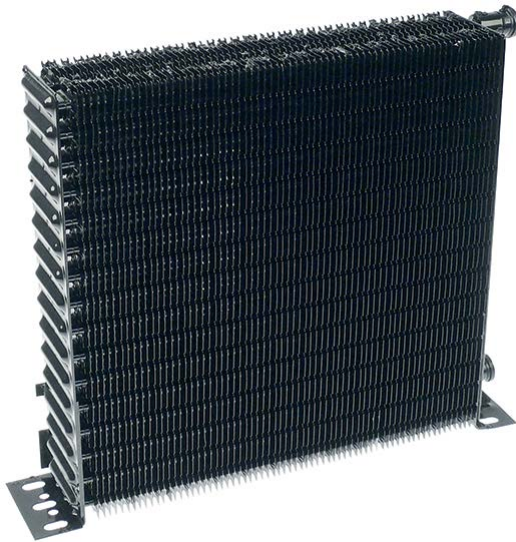

1

Part No.	750409	Ref. No.	20175 20558
description	condenser W 260mm D 60mm H 250mm mounting distance 275mm connection ø 8mm		
For models:	CB640, CB640-CubeA, G150, GB1540, GB1555, IF75, IMF80, TB1405		



1

Part No.	750183	Ref. No.	20175
description	condenser W 270mm D 90mm H 270mm		

condensers water-cooled



1

Part No.	750392	Ref. No.	14034
description	condenser tube \varnothing 15mm water-cooled \varnothing 255mm mounting distance 128mm		
For models:	C80, C80-CubeA, CB1265, CB1265-CubeA, CB640, CB640-CubeA, CB840, CB955, CB955-CubeA, F230, G250, M800, VB250		

evaporation and condensing trays

evaporation trays



1

Part No.	750393	Ref. No.	10395
description	evaporation tray unheated L 705mm W 225mm H 120mm for ice maker Qty 1 pcs		
For models:	VM500, VM900		

unheated condensing trays



1

Part No.	750316	Ref. No.	C10314
description	condensing tray L 160mm W 80mm H 85mm		
For models:	G500, G500-Split		

transmission technology and ball bearings

ball bearings

deep-groove ball bearings 2RS



1

Part No.	523075	Ref. No.	20782
description	ball bearing shaft \varnothing 25mm ED \varnothing 42mm W 9mm type 6905-2RS DIN 625-1		
For models:	G150, GB1540, GB1555, GB902, GB903		



1

Part No.	523522	Ref. No.	20045 20339
description	deep-groove ball bearing type 6004-2RS shaft \varnothing 20mm ED \varnothing 42mm W 12mm with sealing discs deep-groove ball bearing DIN 625-1		
For models:	FB802, GB1540, GB1555, GB902, GB903, M1500, M1500-Split, M350, M350-Split, M600, M600-Split, M800, M800-Split		



1

Part No.	523511	Ref. No.	20433
description	deep-groove ball bearing type 6203-2RS shaft \varnothing 17mm ED \varnothing 40mm W 12mm with sealing discs deep-groove ball bearing DIN 625-1		
For models:	GB1540, GB1555, GB902		



			
1			
Part No.	523513	Ref. No.	20112
description	deep-groove ball bearing type 6205-2RS shaft \varnothing 25mm ED \varnothing 52mm W 15mm with sealing discs deep-groove ball bearing DIN 625-1		
For models:	F230, G250, G500		

			
1			
Part No.	523524	Ref. No.	20113
description	deep-groove ball bearing type 6206-2RS shaft \varnothing 30mm ED \varnothing 62mm W 16mm with sealing discs deep-groove ball bearing DIN 625-1		
For models:	F230, G1000, G1000-Split, G250, G500, G500-Split		

thrust ball bearings			
			
1			
Part No.	523052	Ref. No.	20685
description	thrust ball bearing shaft \varnothing 30mm ED \varnothing 62mm W 42mm type 500-4251 DIN 711		
For models:	G1000, G1000-Split, G250, G500, G500-Split		

miscellaneous			
			
1			
Part No.	523015	Ref. No.	20623 20623E 20632 20686
description	ball bearing type 500-4252 shaft \varnothing 19mm ED \varnothing 40mm W 30mm stainless steel		
For models:	G150, GB1540, GB1555, GB902, GB903		

springs

torsion springs

			
1			
Part No.	699156	Ref. No.	20810
description	spring \varnothing 26mm L2 35mm L1 25mm L3 20mm		
For models:	IMF28, IMF80		

compression springs

			
1			
Part No.	699155	Ref. No.	20499
description	spring \varnothing 8.5mm L 19.5mm wire gauge \varnothing 0.5mm windings 10 for door		
For models:	CB1265, CB1565, CB246, CB249, CB316, CB416, CB425, CB640, CB840, CB955, GB1540, GB1555, GB902, IC30		

tension springs

			
1			
Part No.	695544	Ref. No.	20282 N20282
description	tension spring \varnothing 10.5mm total length 42mm wire gauge \varnothing 1.5mm		
For models:	IF55, IF75		

			
1			
Part No.	695108	Ref. No.	20228
description	tension spring \varnothing 6.3mm total length 21mm wire gauge \varnothing 0.5mm		
For models:	IF26, IF29, IF30, IF55, IF75		

			
1			
Part No.	695435	Ref. No.	20232
description	tension spring \varnothing 9.2mm total length 24mm wire gauge \varnothing 1.6mm		
For models:	IF26, IF29, IF30, IF55, IF75		



hoses

industrial hoses

silicone hoses

without fabric

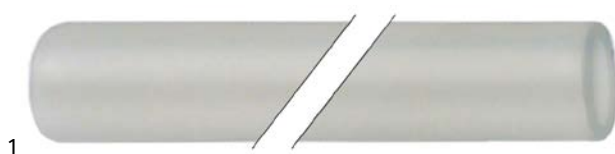

Part No.	530754	Ref. No.	13107
description	silicone hose ID ø 13mm ED ø 19mm L 0.13m t.max. 200°C for ice-cube maker		
For models:	CB1265, CB1565, CB316, CB316-CubeA, CB416, IC30, IF30, IMF58, IMF80		

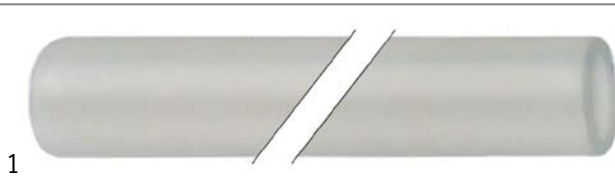

Part No.	530752	Ref. No.	13106
description	silicone hose ID ø 13mm ED ø 19mm L 0.15m t.max. 200°C for ice-cube maker		
For models:	CB249, IF29, IMF80, VB250		

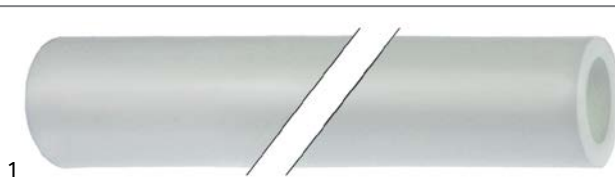

Part No.	530757	Ref. No.	13108
description	silicone hose ID ø 13mm ED ø 19mm L 0.24m t.max. 200°C for ice-cube maker		
For models:	CB425, CB425-CubeA, DSS42, DSS42-CubeD, IceWater45, IF55, IF75, VB250		

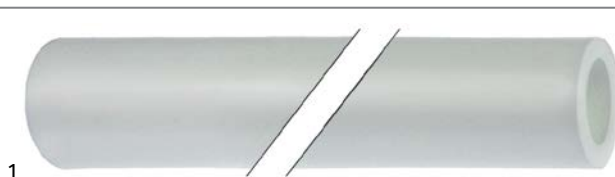

Part No.	530758	Ref. No.	13109
description	silicone hose ID ø 13mm ED ø 19mm L 0.26m t.max. 200°C for ice-cube maker		
For models:	CB1265-CubeA, CB1565-CubeA, CB640, CB640-CubeA, CB840		

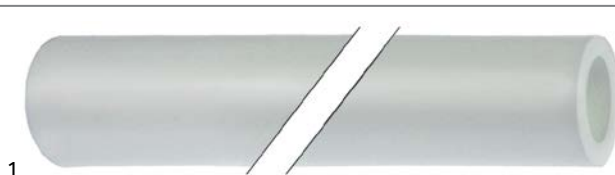

Part No.	530759	Ref. No.	13110
description	silicone hose ID ø 13mm ED ø 19mm L 0.35m t.max. 200°C for ice-cube maker		
For models:	CB955, CB955-CubeA		



Part No.	530749	Ref. No.	13105
description	silicone hose ID ø 13mm ED ø 19mm L 0.7m t.max. 200°C for ice-cube maker		
For models:	CB246, CB246-CubeA, IC24, IF26		



Part No.	530731	Ref. No.	13056
description	silicone hose ID ø 16mm ED ø 23mm L 0.03m t.max. 200°C for ice-cube maker		
For models:	CB134, CB184, FreshMaker, IC18		

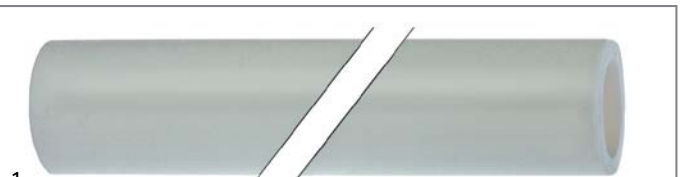

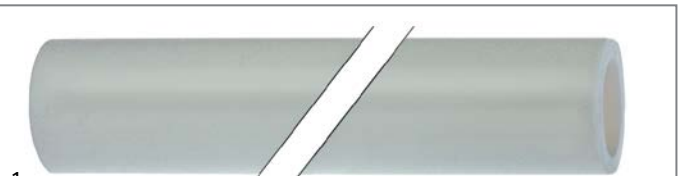

Part No.	530737	Ref. No.	13137
description	silicone hose ID ø 16mm ED ø 23mm L 0.29m t.max. 200°C for ice-cube maker		
For models:	C150, CB249, CB316, CB416		



Part No.	530738	Ref. No.	13139
description	silicone hose ID ø 16mm ED ø 23mm L 0.4m t.max. 200°C for ice-cube maker		
For models:	CB425, IceWater45		





			
1			
Part No.	530739	Ref. No.	13140
description	silicone hose ID ø 16mm ED ø 23mm L 0.5m t.max. 200°C for ice-cube maker		
For models:	CB640, CB840, DSS42		

			
1			
Part No.	530741	Ref. No.	13142
description	silicone hose straight for ice-cube maker ID ø 16mm ED ø 23mm L 645mm		
For models:	CB1265, CB1565		

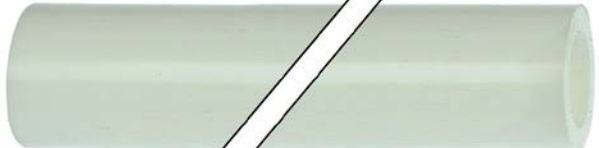
			
1			
Part No.	530740	Ref. No.	13141
description	silicone hose ID ø 16mm ED ø 23mm L 0.61m t.max. 200°C for ice-cube maker		
For models:	CB955		

			
1			
Part No.	530735	Ref. No.	13134
description	silicone hose straight for ice-cube maker ID ø 16mm ED ø 23mm L 700mm		
For models:	VM1700, VM350, VM500, VM900		

			
1			
Part No.	530764	Ref. No.	13138
description	silicone hose ID ø 18mm ED ø 27mm L 0.3m t.max. 200°C for ice-cube maker		
For models:	CB316, CB416, CB425		

			
1			
Part No.	530736	Ref. No.	13136
description	silicone hose straight for ice-cube maker ID ø 18mm ED ø 25mm L 213mm		
For models:	C80, CB246		

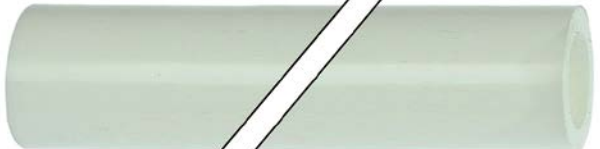
			
1			
Part No.	530734	Ref. No.	13113
description	silicone hose straight for ice-cube maker ID ø 16mm ED ø 23mm L 320mm		
For models:	VB250, VM350, VM500, VM900		

fittings, hose and pipe connectors

hose connectors

producer-specific

			
1			
Part No.	695533	Ref. No.	10404
description	butt splice connector thread M23x1.5 for hose ID 18mm		
For models:	C150, C80, CB1265, CB1565, CB246, CB249, CB316, CB416, CB425, CB640, CB840, CB955, DSS42, IceWater45		

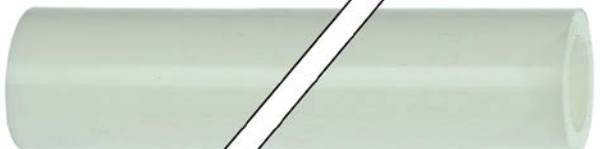
			
1			
Part No.	530733	Ref. No.	13111
description	silicone hose straight for ice-cube maker ID ø 16mm ED ø 23mm L 500mm		
For models:	VB250, VM1700, VM350, VM500, VM900		

water cycle components

supply filters

			
1			
Part No.	695531	Ref. No.	10139
description	supply filter thread 1" total length 100mm plastic with metal filter ø 18mm		
For models:	CB134, CB184, FreshMaker, IC18, VB250, VM350, VM500, VM900		

GASTROPARTS.COM

