



GASTROPARTS

Berner

[EN] Equipment

[DE] Geräte

[ES] Aparatos

[FR] Équipement

[IT] Attrezzature

[PL] Urządzenia

[RU] Оборудование

✉ gastroparts@gastroparts.com

☎ +48 56 657 00 66

📘 fb.com/gastroparts.global



GASTROPARTS.COM







heating elements

heating elements for salamanders/toast-

			
1			
Part No.	416001	Ref. No.	700102
description	radiation heater rectangular 1500W 230/240V L 265mm W 165mm H 32mm heating circuits 1 connections 2 connection type cable cable length 700mm EGO salamander grill		
accessories for	416001		
	Part No.	390880	Ref. No. —
	safety rod thermostat switch-off temp. 780°C temperature range°C 2-pole 1NC/1NOA probe ø 4mm probe L 170mm capillary pipemm capillary pipe isolatedmm gland nut shaft ømm		
	Part No.	403523	Ref. No. —
	solid state relay ANLY 1 phase 40A 24-280V 4-32VDC L 47.5mm W 43mm screw type ASR-40DA		

radiation heaters

			
1			
Part No.	416001	Ref. No.	700102
description	radiation heater rectangular 1500W 230/240V L 265mm W 165mm H 32mm heating circuits 1 connections 2 connection type cable cable length 700mm EGO salamander grill		
accessories for	416001		
	Part No.	390880	Ref. No. —
	safety rod thermostat switch-off temp. 780°C temperature range°C 2-pole 1NC/1NOA probe ø 4mm probe L 170mm capillary pipemm capillary pipe isolatedmm gland nut shaft ømm		
	Part No.	403523	Ref. No. —
	solid state relay ANLY 1 phase 40A 24-280V 4-32VDC L 47.5mm W 43mm screw type ASR-40DA		

energy regulators

EGO

1-circuit

			
1			
Part No.	380015	Ref. No.	— 800400
description	energy regulator 230V 13A single-circuit turn direction right shaft ø 6x4.6mm shaft L 23mm mounting thread M4 power release 6-100% no. 50.57021.010		

thermostats

control and safety thermostats

EGO

safety thermostats

55.32_ series

			
1			
Part No.	390787	Ref. No.	300109 300169
description	safety thermostat switch-off temp. 237°C 3-pole 20A probe ø 6mm probe L 98mm capillary pipe 1420mm capillary pipe isolated 1170mm gland nut shaft ø M10x1mm probe		

control thermostats with operation switch

55.34_ series

			
1			
Part No.	390788	Ref. No.	400300
description	thermostat t.max. 180°C temperature range 0-180°C 3-pole 3NOA probe ø 6mm probe L 130mm capillary pipe 1740mm capillary pipe isolated 1310mm gland nut M10x1 shaft ø 6x4.6mm shaft L 23mm shaft position upper rotation 270° outer switch 2NO/2NO up to 180°C		

			
1			
Part No.	375955	Ref. No.	500301 700104
description	thermostat t.max. 310°C temperature range 64-310°C 3-pole 3NO 16A probe ø 3mm probe L 165mm capillary pipe 1590mm capillary pipe isolated 1400mm gland nut shaft ø 6x4.6mm shaft L 23mm shaft position upper shaft position° rotation 270° outer switch 2NO/2NO		



switches and momentary switches

cam switches

with potentiometer



1

Part No.	300249	Ref. No.	100106 100133 LP1-100108
description	cam switch 2 operating positions 2NO sequence 0-1 16A shaft \varnothing 6x4.6mm shaft L 23mm connection screw 10K/J cable lengthmm 10kOhm ceramic		



1

Part No.	300199	Ref. No.	100108
description	operation switch 0-1 16A shaft \varnothing 6x4.6mm shaft L 23mm connection male faston 6.3mm 10K/J 2-pole with potentiometer		

encoders and potentiometers

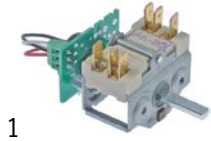

1

Part No.	300249	Ref. No.	100106 100133 LP1-100108
description	cam switch 2 operating positions 2NO sequence 0-1 16A shaft \varnothing 6x4.6mm shaft L 23mm connection screw 10K/J cable lengthmm 10kOhm ceramic		



1

Part No.	300199	Ref. No.	100108
description	operation switch 0-1 16A shaft \varnothing 6x4.6mm shaft L 23mm connection male faston 6.3mm 10K/J 2-pole with potentiometer		

lamps

indicator lights

indicator lights (complete)

 \varnothing 8mm

1

Part No.	359906	Ref. No.	100128
description	indicator light \varnothing 8mm 230V clear cable length 600mm		

relays

solid state relays



1

Part No.	381423	Ref. No.	800317 800318
description	relay PANASONIC 250VAC 1NO at 250V 40A manuf. no. AQA611VL		

probes

producer-specific probes

probes



1

Part No.	378003	Ref. No.	100127
description	temperature probe NTC cable PVC probe -40 up to +125°C cable -10 up to 100°C connection coded plug thread cable length 0.24m		

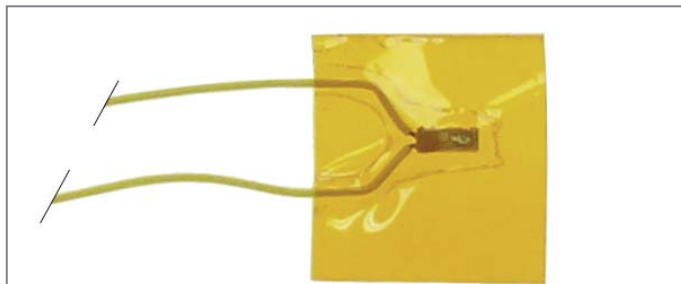

1

Part No.	378001	Ref. No.	100114 100363
description	temperature probe Pt1000 probe -70 up to +500°C cable length 0.5m		



1

Part No.	378002	Ref. No.	100126
description	temperature probe PTC 1kOhm cable probe -50 up to +150°C cable°C connection 2-wire thread probe ø2x2mm cable lengthm		

electronics

rectifiers

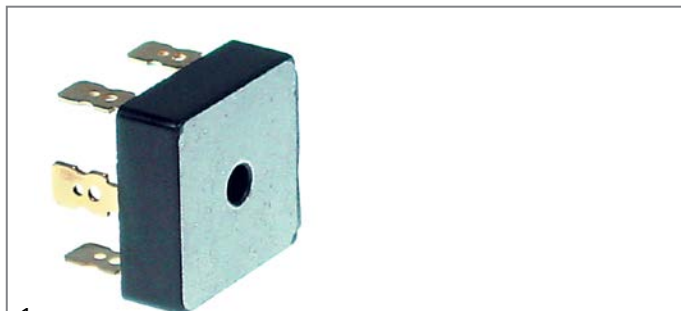

1

Part No.	401501	Ref. No.	100116
description	rectifier		

PCBs

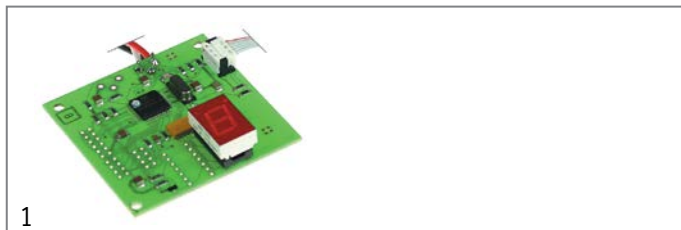

1

Part No.	401496	Ref. No.	500232
description	control PCB		



1

Part No.	401499	Ref. No.	100119
description	control PCB		



1

Part No.	402298	Ref. No.	100118 100602
description	control PCB		



1

Part No.	401500	Ref. No.	100129
description	display PCB		



1

Part No.	401495	Ref. No.	500736
description	PCB 2.5kW		

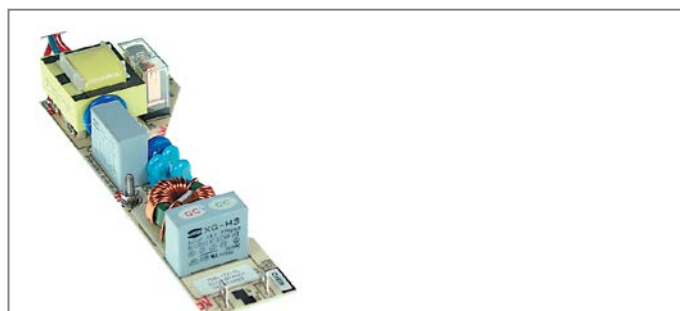

1

Part No.	401494	Ref. No.	500235
description	PCB flow control valve 3kW		



1

Part No.	400074	Ref. No.	800501
description	PCB pyroceram range 400V		



			
1			
Part No.	401497	Ref. No.	100620
description	power PCB		

			
1			
Part No.	401498	Ref. No.	100120
description	power PCB		

fans

axial fans

import

			
1			
Part No.	601679	Ref. No.	100302 100329
description	axial fan L 60mm W 60mm H 25mm 24VDC 1.9W bearing magnetic bearing connection cable cable length 300mm SUNON fan wheel ø 55mm temp.-resist. -10 up to +70°C housing plastic		

			
1			
Part No.	601335 ¹	Ref. No.	100301
description	axial fan L 80mm W 80mm H 25mm 24VDC 1.7W bearing slide bearing connection cable plastic SUNON fan wheel ø 75mm temp.-resist. 70°C		

¹with slide bearings

electronic components

transistor

			
1			
Part No.	401502	Ref. No.	100115
description	transistor type IGBT		

knobs

producer-specific knobs

BERNER

			
1			
Part No.	112642	Ref. No.	801110
description	knob energy regulator 1-10 ø 50mm shaft ø 6x4.6mm shaft flat lower		

			
1			
Part No.	112025	Ref. No.	100117
description	knob potentiometer 1-6 ø 54mm shaft ø 6x4.6mm shaft flat lower		

			
1			
Part No.	112024	Ref. No.	100107
description	knob potentiometer MIN/MAX ø 54mm shaft ø 6x4.6mm shaft flat lower		

GASTROPARTS.COM

