



GASTROPARTS

Bartscher

- [EN]** Equipment
- [DE]** Geräte
- [ES]** Aparatos
- [FR]** Équipement
- [IT]** Attrezzature
- [PL]** Urządzenia
- [RU]** Оборудование

✉ gastroparts@gastroparts.com

☎ +48 56 657 00 66

🌐 fb.com/gastroparts.global

GASTROPARTS.COM





induction

induction coils



1

Part No.	404000	Ref. No.	01058352
description	induction coils 3500W 230V 50Hz L 220mm W 217mm H 12mm suitable for BARTSCHER for induction device		

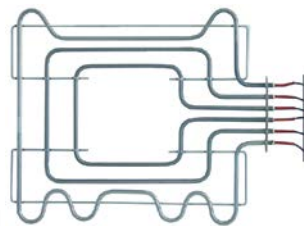

1

Part No.	416785	Ref. No.	016727
description	heating element 1800W 230/400V heating circuits 3 L 515mm W 452mm L1 57mm L2 458mm W1 162mm W2 128mm flange length 160mm flange width 22mm hole distance 144mm hole ø M5mm tube ø 8.5mm rectangular flange dry heating element oven cable length 570mm		

heating elements

heating elements for ovens



1

Part No.	418478	Ref. No.	065211001 065211007
description	heating element 1000W 230V heating circuits 1 L 420mm W 200mm connection male faston 6.3mm connection distance 194mm connection length 15mm tube ø 6.3mm dry heating element oven/ bain marie H 47mm		

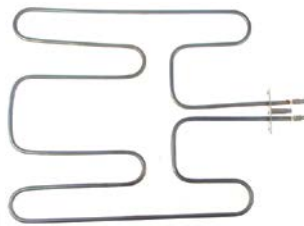

1

Part No.	418546	Ref. No.	021061
description	heating element 1800W 230V heating circuits 1 L 405mm W 324mm L1 30mm L2 375mm W2 30mm flange length 72mm flange width 22mm hole distance 57mm hole ø 5mm tube ø 6.3mm connection male faston 6.3mm connection length 55mm mounting pos. lower rectangular flange dry heating element oven		

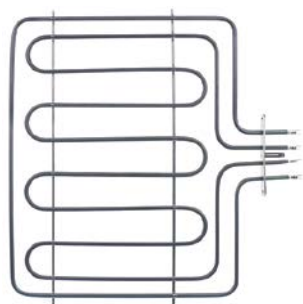

1

Part No.	418961	Ref. No.	023319
description	heating element 1200/2850W 230V heating circuits 2 L 400mm W 467mm L1 40mm L2 360mm W1 70mm W2 78mm flange length 127mm flange width 22mm hole distance 114mm bridge length 35mm hole ø 6mm tube ø 6.3mm connection male faston 6.3mm vertical connection length 17mm windings 4		

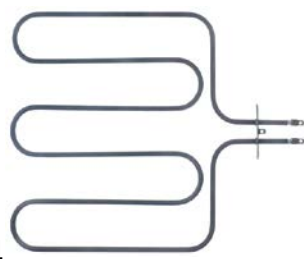

1

Part No.	420040	Ref. No.	A0YXD4A40
description	heating element 2000W 230V heating circuits 1 L 330mm W 315mm L1 55mm L2 275mm W1 142mm W2 31mm flange length 70mm flange width 22mm hole distance 56mm hole ø 6mm tube ø 6.6mm connection male faston 6.3mm		
For models:	A120788		

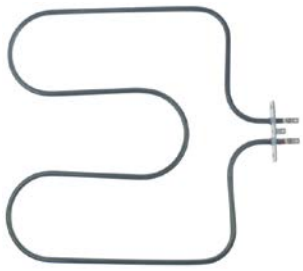

1

Part No.	420276	Ref. No.	ORES009
description	heating element 1500W 230V heating circuits 1 L 313mm W 300mm L1 48mm L2 305mm W1 135mm W2 30mm flange length 70mm flange width 22mm hole distance 56mm hole ø 5mm tube ø 6.5mm connection male faston 6.3mm windings 2 oven heating element		

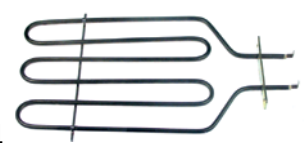

1

Part No.	416855	Ref. No.	030008373
description	heating element 2300W 230V heating circuits 1 L 345mm W 213mm L1 33mm L2 42mm W1 70mm W2 68mm flange length 130mm flange width 16mm hole distance 104mm hole ø 3mm tube ø 6.3mm connection male faston 6.3mm connection length 48mm rectangular flange dry heating element L3 270mm		

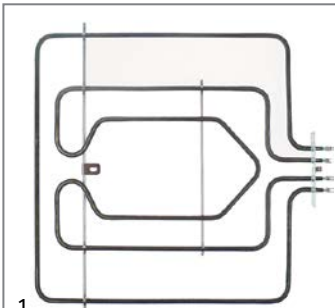
Part No.	420275	Ref. No.	ORES039
description	heating element 2400W 230V heating circuits 2 L 335mm W 350mm L1 30mm L2 305mm W1 145mm W2 60mm flange length 100mm flange width 22mm hole distance 86mm hole \varnothing 5mm tube \varnothing 6.5mm connection male faston 6.3mm oven heating element		

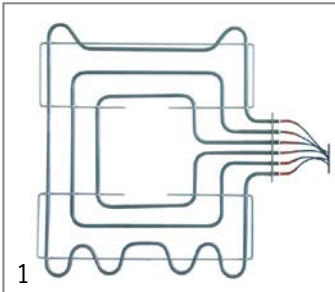

Part No.	416786	Ref. No.	010848
description	heating element 2750W 230/400V heating circuits 3 L 515mm W 580mm L1 55mm L2 460mm W1 130mm W2 225mm flange length 160mm flange width 22mm hole distance 139mm hole \varnothing 4mm tube \varnothing 8.5mm connection cable rectangular flange dry heating element oven cable length 590mm		

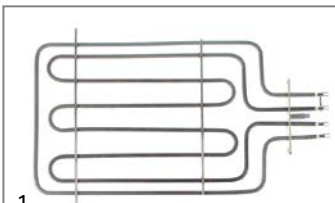

Part No.	418545	Ref. No.	021060
description	heating element 3100W 230V heating circuits 2 L 415mm W 258mm L1 38mm L2 377mm W1 89mm W2 80mm flange length 128mm flange width 22mm hole distance 114mm bridge length 300mm hole \varnothing 4.5mm tube \varnothing 6.5mm connection male faston 6.3mm connection length 65mm mounting pos. upper rectangular flange dry heating element oven		



Part No.	418479	Ref. No.	06530624
description	heating element 950W 230V heating circuits 1 L 405mm W 96mm L1 75mm L2 330mm W1 15mm W2 66mm flange length 110mm flange width 22mm hole distance 95mm connection male faston 6.3mm connection length 18mm tube \varnothing 6.3mm rectangular flange hole \varnothing 5mm dry heating element heated cabinet		

heating elements for bain maries



Part No.	418478	Ref. No.	065211001 065211007
description	heating element 1000W 230V heating circuits 1 L 420mm W 200mm connection male faston 6.3mm connection distance 194mm connection length 15mm tube \varnothing 6.3mm dry heating element oven/bain marie H 47mm		

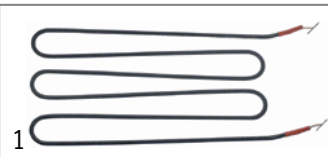

Part No.	417748	Ref. No.	00SL0006
description	heating element 1200W 230V heating circuits 1 L 365mm W 190mm connection cable 500mm tube \varnothing 6.3mm		



Part No.	420542	Ref. No.	OKG1652
description	heating element 1200W 230V heating circuits 1 L 370mm W 185mm connection M4 connection distance 180mm tube \varnothing 6.5mm mounting pos. lower bain marie		

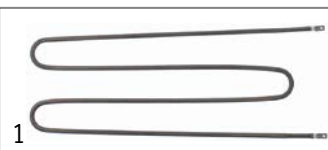

Part No.	417707	Ref. No.	02002301
description	heating element 1300W 230V heating circuits 1 L 405mm W 150mm tube \varnothing 6.8mm		



Part No.	416067	Ref. No.	06001024
description	heating element 1380W 230V heating circuits 1 L 346mm W 190mm connection M5 tube \varnothing 8.5mm 2 hole fixing thread 1/4" immersion heater W1 70mm W2 105mm H 27mm mounting distance 67mm		







spare parts for	416067			
	Part No.	510417	Ref. No.	—
	flat gasket fibre ED \varnothing 20mm ID \varnothing 14mm thickness 2mm Qty 1 pcs			
accessories for	416067			
	Part No.	361182	Ref. No.	—
	nut thread 1/4" H 5mm nickel-plated brass WS 17 Qty 1 pcs			
	Part No.	520228	Ref. No.	—
	tooth lock washer ID \varnothing 15.3mm ED \varnothing 24mm steel Qty 1 pcs for thread M14			
	Part No.	550262	Ref. No.	—
	flat gasket copper ED \varnothing 20mm ID \varnothing 14mm thickness 2mm			





Table continues overleaf

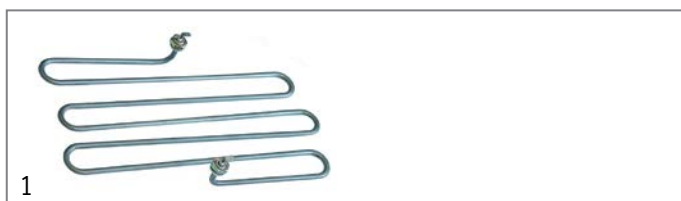

accessories for	416067			
	Part No.	560112	Ref. No.	—
	plain washer ID ø 5.3mm ED ø 10mm thickness 1mm SS Qty 20 pcs DIN 125A for thread M5			
	Part No.	560132	Ref. No.	—
	hexagonal nut thread M5 H 4mm WS 8 SS DIN/ISO DIN 934 / ISO 4032/8673 Qty 20 pcs			



Part No.	416796	Ref. No.	018160
description	heating element 1500W 240V heating circuits 1 L 325mm W 180mm connection male faston 6.3mm tube ø 6.3mm 2 hole fixing thread 1/4" dry heating element bain marie L1 155mm L2 170mm H 34mm mounting distance 174mm		

accessories for	416796			
	Part No.	361182	Ref. No.	—
	nut thread 1/4" H 5mm nickel-plated brass WS 17 Qty 1 pcs			
	Part No.	510417	Ref. No.	—
	flat gasket fibre ED ø 20mm ID ø 14mm thickness 2mm Qty 1 pcs			
	Part No.	520228	Ref. No.	—
	tooth lock washer ID ø 15.3mm ED ø 24mm steel Qty 1 pcs for thread M14			
	Part No.	550262	Ref. No.	—
	flat gasket copper ED ø 20mm ID ø 14mm thickness 2mm			

heating elements for chip scuttles



Part No.	416067	Ref. No.	06001024
description	heating element 1380W 230V heating circuits 1 L 346mm W 190mm connection M5 tube ø 8.5mm 2 hole fixing thread 1/4" immersion heater W1 70mm W2 105mm H 27mm mounting distance 67mm		

accessories for	416067			
	Part No.	510417	Ref. No.	—
	flat gasket fibre ED ø 20mm ID ø 14mm thickness 2mm Qty 1 pcs			

accessories for	416067			
	Part No.	361182	Ref. No.	—
	nut thread 1/4" H 5mm nickel-plated brass WS 17 Qty 1 pcs			

	Part No.	520228	Ref. No.	—
	tooth lock washer ID ø 15.3mm ED ø 24mm steel Qty 1 pcs for thread M14			

	Part No.	550262	Ref. No.	—
	flat gasket copper ED ø 20mm ID ø 14mm thickness 2mm			

	Part No.	560112	Ref. No.	—
	plain washer ID ø 5.3mm ED ø 10mm thickness 1mm SS Qty 20 pcs DIN 125A for thread M5			

	Part No.	560132	Ref. No.	—
	hexagonal nut thread M5 H 4mm WS 8 SS DIN/ISO DIN 934 / ISO 4032/8673 Qty 20 pcs			

heating elements for crepes makers

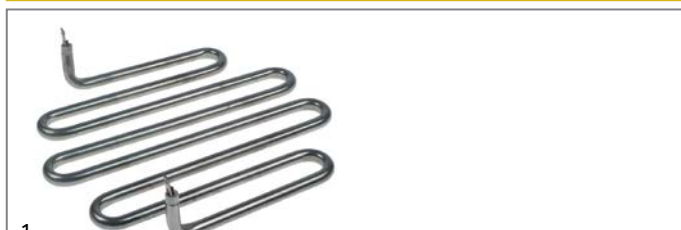

Part No.	419011	Ref. No.	010444611
description	heating element 3000W 230V L 307mm W 272mm H 50mm connection distance 260mm dry heating element heating circuits 1 for crepes maker		
For models:	104447		



Part No.	419203	Ref. No.	0301040775
description	heating element kit 3000W 230V H 50mm tube ø 8.5mm connection screw connection distance 30mm dry heating element heating circuits 1 ø 325mm for crepes maker		

heating elements for fryers

center connection

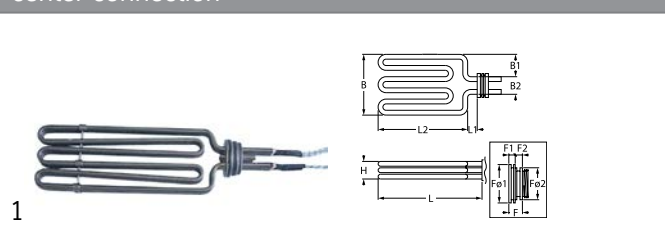

Part No.	415297	Ref. No.	0211441
description	heating element 6800W 230/400V heating circuits 3 L 299mm W 107mm H 35mm flange length 19.5mm flange length 1 9.5mm flange length 2 9.8mm flange ø1 62mm flange ø2 57mm thermostat sleeves ø 8.5mm sensor screw connection 2x M10x1 thermostat sleeve upper/ lower L1 16mm L2 283mm W1 30mm W2 77mm thread M54x1.5 tube ø 8.5mm cable length 450mm rotation flange immersion heater		

accessories for	415297			
	Part No.	510243	Ref. No.	—
	O-ring Viton thickness 3.53mm ID ø 55.56mm Qty 1 pcs			

	Part No.	510245	Ref. No.	—
	O-ring Viton thickness 3.53mm ID ø 50.8mm Qty 1 pcs			

	Part No.	550447	Ref. No.	—
	ring nut thread M54x1.5			





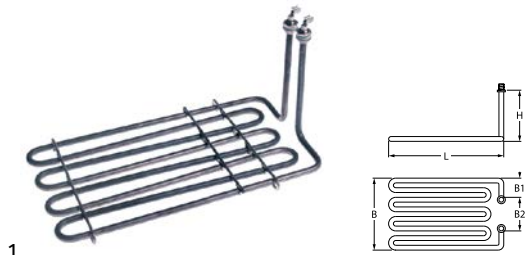

2 hole fixing



Part No.	418488	Ref. No.	06537366
description	heating element 2800W 230V heating circuits 1 L 343mm W 180mm H 152mm 2 hole fixing connection male faston 6.3mm W1 66mm W2 44mm thread M12x1 tube \varnothing 8.5mm windings 4 fryer		

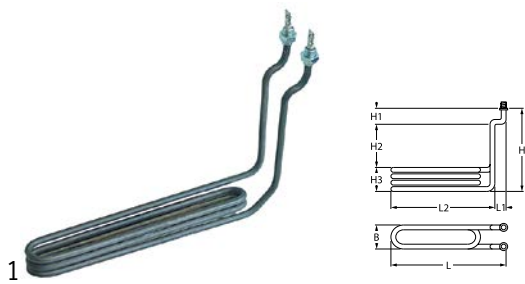

accessories for 418488

	Part No.	520229	Ref. No.	—
	nut thread M12x1 H 4mm WS 16 zinc-coated steel Qty 1 pcs			
	Part No.	521110	Ref. No.	—
	flat gasket fibre ED \varnothing 20mm ID \varnothing 13mm thickness 2mm Qty 1 pcs			
	Part No.	521131	Ref. No.	—
	nut thread M12x1 H 3.5mm WS 17 SS Qty 1 pcs			
	Part No.	528110	Ref. No.	—
	O-ring EPDM thickness 2.62mm ID \varnothing 12.37mm Qty 1 pcs			



Part No.	416800	Ref. No.	08208200
description	heating element 2300W 230V heating circuits 1 L 340mm W 42mm H 210mm L1 24mm L2 316mm H1 46mm H2 130mm H3 34mm mounting distance 32mm thread M14x1.5 tube \varnothing 8.5mm connection length 20mm connection M5 2 hole fixing fryer		

spare parts for 416800

	Part No.	521101	Ref. No.	—
	nut thread M14x1.5 H 5mm WS 19 SS Qty 1 pcs			
accessories for	416800			
	Part No.	560112	Ref. No.	—
	plain washer ID \varnothing 5.3mm ED \varnothing 10mm thickness 1mm SS Qty 20 pcs DIN 125A for thread M5			
	Part No.	560132	Ref. No.	—
	hexagonal nut thread M5 H 4mm WS 8 SS DIN/ISO DIN 934 / ISO 4032/8673 Qty 20 pcs			

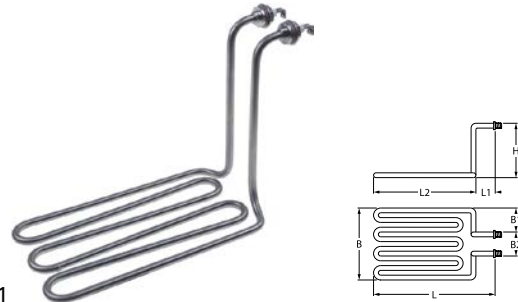

Part No.	420145	Ref. No.	016240419 A039885
description	heating element 2500W 230V heating circuits 1 L 267mm W 127mm H 187mm 2 hole fixing connection M4 immersion heater L1 32mm L2 235mm W1 38mm W2 50mm tube \varnothing 8mm thread M12x1.25 mounting distance 42mm connection length 15mm windings 3		

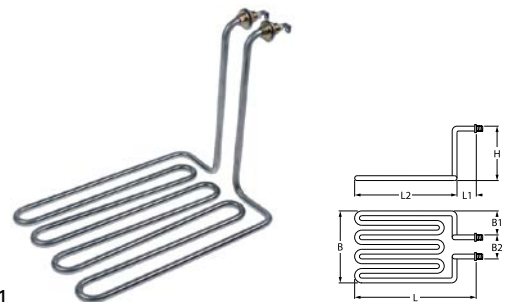

Part No.	420018	Ref. No.	016210818 A040579
description	heating element 3250W 230V heating circuits 1 L 265mm W 185mm H 200mm 2 hole fixing connection M4 immersion heater L1 25mm L2 240mm W1 71mm W2 42mm tube \varnothing 8.1mm thread M12x1 mounting distance 34mm windings 4		

For models: A150107, A150207

spare parts for 420018

	Part No.	521131	Ref. No.	—
	nut thread M12x1 H 3.5mm WS 17 SS Qty 1 pcs			







Part No.	420066	Ref. No.	A039886
description	heating element 3250W 230V heating circuits 1 L 280mm W 180mm H 210mm 2 hole fixing connection M4 immersion heater L1 35mm L2 245mm W1 61mm W2 58mm tube \varnothing 8.1mm thread M12x1.25 mounting distance 50mm windings 4		



6 hole fixing

1

Part No.	416811	Ref. No.	01037317200
description	heating element 9000W 230V heating circuits 3 L 320mm W 175mm H 205mm W1 5mm H1 165mm H2 40mm thread M12x1 tube ø 8.5mm connection male faston 6.3mm immersion heater 6 hole fixing		
spare parts for	416811		
	Part No.	521110	Ref. No. —
	flat gasket fibre ED ø 20mm ID ø 13mm thickness 2mm Qty 1 pcs		
accessories for	416811		
	Part No.	520229	Ref. No. —
	nut thread M12x1 H 4mm WS 16 zinc-coated steel Qty 1 pcs		
	Part No.	521131	Ref. No. —
	nut thread M12x1 H 3.5mm WS 17 SS Qty 1 pcs		
	Part No.	528110	Ref. No. —
	O-ring EPDM thickness 2.62mm ID ø 12.37mm Qty 1 pcs		

heating elements for hot counters

1

Part No.	420065	Ref. No.	03060533
description	heating element 1840W 230V heating circuits 1 L 550mm W 180mm W2 38mm tube ø 8mm connection M4 for hot counter L1 65mm L2 410mm hole distance 187mm flange length 200mm flange width 50mm hole ø 5mm		

1

Part No.	420039	Ref. No.	A02030937
description	heating element 260W 230V heating circuits 1 L 221mm W 363mm tube ø 8mm connection male faston 6.3mm screw lug length 40mm lug width 15mm		
For models:	A203093, A203094		

heating elements for griddles

1

Part No.	418934	Ref. No.	021786
description	heating element 1100W 230V heating circuits 1 L 327mm W 96.5mm H 52mm tube ø 6.3mm connection male faston 6.3mm griddle connection distance 76mm dry heating element		

1

Part No.	418489	Ref. No.	065211011
description	heating element 1100W 230V heating circuits 1 L 467mm W 95mm H 52mm tube ø 6.3mm connection M4 griddle dry heating element		

heating elements for hot dog machines

1

Part No.	418661	Ref. No.	A0401022500
description	heating element 1000W 230V L 180mm W 187mm H 18mm tube ø 6.2mm L1 30mm L2 150mm connection 6.3 connection distance 181mm heating circuits 1 hot dog machine		

heating elements for chicken rotisseries

1

Part No.	418869	Ref. No.	007032324
description	heating element 1900W 230V thread M14x1.5 L 690mm W 40mm dry heating element tube ø 8.5mm mounting distance 61mm chicken rotisserie		

heating elements for coffee machine

1

Part No.	420147	Ref. No.	A0ND010
description	heating element 1200W 230V heating circuits 1 D1 ø 65mm H 42mm D2 ø 54mm windings 3 connection male faston 6.3mm immersion heater tube ø 6.5mm for coffee machine		
For models:	A190141, A190161		
accessories for	420147		
	Part No.	511646	Ref. No. A0ND011
	gasket silicone ED ø 63mm ID ø 55mm thickness 2.3mm Qty 1 pcs for heating element		



1

Part No.	420146	Ref. No.	A0ND012
description	heating element 130W 230V ø 130mm L 130mm H 54mm connection male faston 6.3mm W 130mm heating circuits 1		
For models:	A190141, A190161		



1

Part No.	417218	Ref. No.	A040640
description	heating element D1 ø 65mm H 42mm tube ø 6.5mm coffee machine		



1

Part No.	420143	Ref. No.	A0ND037
description	heating element heating circuits 1 D1 ø 65mm H 42mm D2 ø 54mm windings 4 connection male faston 6.3mm immersion heater tube ø 6.5mm for coffee machine		
accessories for	420143		
	Part No.	511646	Ref. No. A0ND011
	gasket silicone ED ø 63mm ID ø 55mm thickness 2.3mm Qty 1 pcs for heating element		

heating elements for tilting bratt pan



1

Part No.	416693	Ref. No.	040400084
description	heating element 1650W 230V L 490mm W 45mm H 45mm 2 hole fixing connection M4 thread 1/4" tube ø 8.5mm mounting distance 32mm dry heating element		
accessories for	416693		
	Part No.	361182	Ref. No. —
	nut thread 1/4" H 5mm nickel-plated brass WS 17 Qty 1 pcs		
	Part No.	510417	Ref. No. —
	flat gasket fibre ED ø 20mm ID ø 14mm thickness 2mm Qty 1 pcs		
	Part No.	520228	Ref. No. —
	tooth lock washer ID ø 15.3mm ED ø 24mm steel Qty 1 pcs for thread M14		
	Part No.	550262	Ref. No. —
	flat gasket copper ED ø 20mm ID ø 14mm thickness 2mm		

heating elements for contact grills

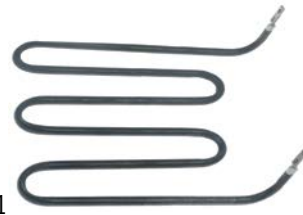

1

Part No.	419013	Ref. No.	A039855
description	heating element 1000W 230V L 178mm W 180mm H 40mm tube ø 6.25mm connection M4 connection length 22mm dry heating element windings 3 for contact grill		
For models:	A150671		



1

Part No.	416845	Ref. No.	A017607
description	heating element 1100W 230V L 208mm W 220mm H 25mm tube ø 6.5mm connection distance 65mm cable length 500mm dry heating element heating circuits 1		



1

Part No.	416853	Ref. No.	A010416
description	heating element 1100W 230V L 210mm W 250mm W1 70mm W2 110mm tube ø 6.3mm cable length 200mm dry heating element windings 3 H 6.3mm		



1

Part No.	419002	Ref. No.	A041537
description	heating element 1400W 230V heating circuits 1 L 175mm W 305mm H 20mm W1 40mm W2 325mm tube ø 6.3mm windings 5		
For models:	A150674		

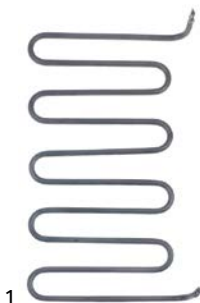
1

Part No.	419003	Ref. No.	A041538
description	heating element 1550W 240V L 175mm W 305mm H 40mm tube ø 6.3mm connection M4 windings 5		
For models:	A150674		



1

Part No.	416844	Ref. No.	A010415
description	heating element 900W 230V L 185mm W 247mm W1 80mm W2 100mm tube ø 6.3mm connection cable connection length 18mm cable length 600mm windings 3 H 6.3mm		



1

Part No.	416843	Ref. No.	A010414
description	heating element 650W 230V L 172mm W 162mm W1 70mm W2 40mm tube ø 6.5mm connection cable cable length 550mm dry heating element windings 3		



1

Part No.	416854	Ref. No.	030008014
description	heating element 900W 230V L 210mm W 170mm H 20mm W1 55mm W2 60mm tube ø 6.3mm windings 3 cable length 250mm dry heating element		



1

Part No.	419012	Ref. No.	A039854
description	heating element 800W 230V heating circuits 1 L 175mm W 183mm H 15mm W1 40mm W2 102mm tube ø 6.6mm windings 3 connection M4 mounting pos. upper dry heating element for contact grill		
For models:	A150671		

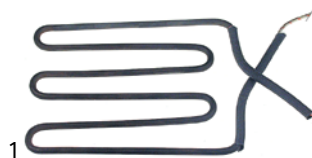

1

Part No.	416859	Ref. No.	A010418
description	heating element 900W 230V L 210mm W 180mm W1 33mm W2 100mm tube ø 6.3mm connection cable connection length 20mm cable length 240mm windings 3 H 6.3mm		

heating elements for pizza ovens



1

Part No.	416849	Ref. No.	030008013
description	heating element 800W 230V L 170mm W 167mm H 33mm W1 26mm W2 115mm connection length 30mm tube ø 6.3mm windings 3 cable length 260mm dry heating element		

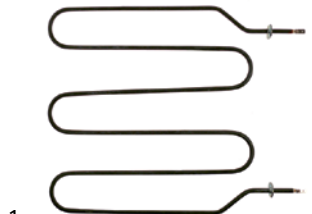

1

Part No.	418672	Ref. No.	0401031000
description	heating element 1000W 230V heating circuits 1 L 330mm W 300mm L1 30mm L2 60mm L3 240mm W1 35mm W2 230mm lug length 27mm lug width 22mm connection length 55mm connection male faston 6.3mm tube ø 6.3mm 2 hole fixing hole ø 3mm dry heating element pizza oven		



1





Part No.	416847	Ref. No.	030008049
description	heating element 1000W 230V dry heating element 2 hole fixing pizza oven		

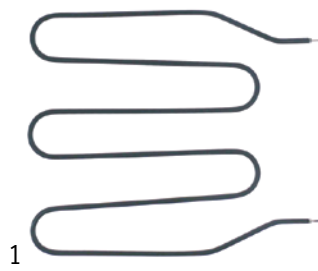

			
Part No.	416848	Ref. No.	030008062
description	heating element 800W 230V L 445mm W 195mm thread 1/4" mounting distance 186mm connection length 15mm connection M4 tube ø 8.5mm heating circuits 1 dry heating element 2 hole fixing		
For models:	ROMA/II		
accessories for	416848		
	Part No.	361182	Ref. No. —
	nut thread 1/4" H 5mm nickel-plated brass WS 17 Qty 1 pcs		
	Part No.	510417	Ref. No. —
	flat gasket fibre ED ø 20mm ID ø 14mm thickness 2mm Qty 1 pcs		
	Part No.	520228	Ref. No. —
	tooth lock washer ID ø 15.3mm ED ø 24mm steel Qty 1 pcs for thread M14		
	Part No.	550262	Ref. No. —
	flat gasket copper ED ø 20mm ID ø 14mm thickness 2mm		

			
Part No.	418781	Ref. No.	A02011008
description	heating element 900W 230V L 350mm W 300mm connection distance 220mm L1 40mm L2 90mm L3 220mm W1 40mm W2 220mm tube ø 6.3mm heating circuits 1 pizza oven		

heating elements for chargrills

			
Part No.	415965	Ref. No.	01037311315
description	heating element 1800W 230V L 486mm W 83mm H 30mm 2 hole fixing mounting distance 72mm connection M4 L1 38mm L2 448mm heating circuits 1 tube ø 6.3mm dry heating element thread M12x1 for sausage warmer		
accessories for	415965		
	Part No.	520229	Ref. No. —
	nut thread M12x1 H 4mm WS 16 zinc-coated steel Qty 1 pcs		
	Part No.	521110	Ref. No. —
	flat gasket fibre ED ø 20mm ID ø 13mm thickness 2mm Qty 1 pcs		
	Part No.	521131	Ref. No. —
	nut thread M12x1 H 3.5mm WS 17 SS Qty 1 pcs		
	Part No.	528110	Ref. No. —
	O-ring EPDM thickness 2.62mm ID ø 12.37mm Qty 1 pcs		

heating elements for salamanders/toast-

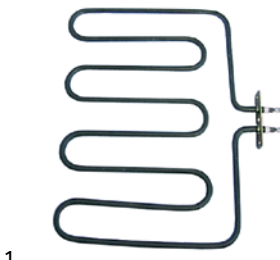
			
Part No.	415659	Ref. No.	011029
description	heating element 2000W 230V heating circuits 1 L 230mm W 303mm L1 35mm L2 195mm W1 135mm W2 33mm flange length 70mm flange width 22mm hole distance 56mm tube ø 8.5mm dry heating element connection M5 rectangular flange hole ø 5mm H 8.5mm		

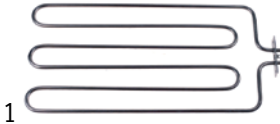
			
Part No.	418740	Ref. No.	OAT93607 AOAT93607
description	heating element 2000W 230V heating circuits 1 L 400mm W 200mm L1 27mm L2 373mm W1 85mm W2 30mm flange length 70mm flange width 22mm hole distance 56mm tube ø 6.5mm rectangular flange hole ø 5mm H 6.5mm		
For models:	A1515001		

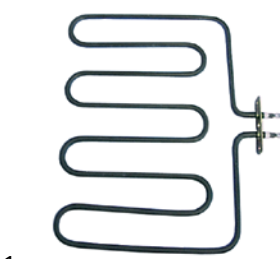
			
Part No.	415660	Ref. No.	011003
description	heating element 2800W 230V heating circuits 1 L 230mm W 298mm L1 20mm L2 210mm W1 133mm W2 32mm flange length 70mm flange width 22mm hole distance 56mm tube ø 8.5mm dry heating element connection M5 rectangular flange hole ø 5mm H 8.5mm		

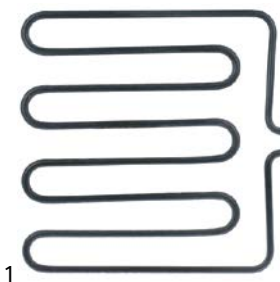
			
Part No.	418790	Ref. No.	011008
description	heating element 2800W 400V heating circuits 1 L 305mm W 300mm L1 18mm L2 287mm W1 130mm W2 25mm flange length 70mm flange width 22mm hole distance 65mm tube ø 8.5mm connection M5 rectangular flange hole ø 5mm salamander grill H 8.5mm		

1

Part No.	418862	Ref. No.	OV036700 A039857 EB-600-15
description	heating element 2000W 230V heating circuits 1 L 235mm W 215mm H 35mm thread M12x1 mounting distance 209mm connection length 48mm tube ø 6.3mm salamander grill		
For models:	EB600		



1

Part No.	418653	Ref. No.	0401024000
description	heating element 2200W 230V L 350mm W 260mm thread M12 mounting distance 245mm connection 6.3 air tube ø 8.5mm heating circuits 1 H 8.5mm		
spare parts for	418653		
	Part No.	521110	Ref. No. —
	flat gasket fibre ED ø 20mm ID ø 13mm thickness 2mm Qty 1 pcs		
accessories for	418653		
	Part No.	520229	Ref. No. —
	nut thread M12x1 H 4mm WS 16 zinc-coated steel Qty 1 pcs		
	Part No.	521131	Ref. No. —
	nut thread M12x1 H 3.5mm WS 17 SS Qty 1 pcs		
	Part No.	528110	Ref. No. —
	O-ring EPDM thickness 2.62mm ID ø 12.37mm Qty 1 pcs		



1

Part No.	420046	Ref. No.	A039856
description	heating element 2800W 230V heating circuits 1 L 240mm W 350mm H 25mm thread M12x1 mounting distance 342mm tube ø 8.5mm connection M4		
For models:	151510		





1

Part No.	416820	Ref. No.	6001071
description	heating element 930W 230V L 260mm W 55mm thread M15x1 mounting distance 45mm connection length 26mm connection M4 tube ø 10mm heating circuits 1 dry heating element 2 hole fixing H 10mm		



1

Part No.	416001	Ref. No.	027676
description	radiation heater rectangular 1500W 230/240V L 265mm W 165mm H 32mm heating circuits 1 connections 2 connection type cable cable length 700mm EGO salamander grill		
accessories for	416001		
	Part No.	390880	Ref. No. 027677
	safety rod thermostat switch-off temp. 780°C temperature range°C 2-pole 1NC/1NOA probe ø 4mm probe L 170mm capillary pipemm capillary pipe isolatedmm gland nut shaft ømm		
	Part No.	403523	Ref. No. —
	solid state relay ANLY 1 phase 40A 24-280V 4-32VDC L 47.5mm W 43mm screw type ASR-40DA		

heating elements for heating bridges



1

Part No.	420019	Ref. No.	A01140015
description	heating element 900W 230V heating circuits 1 L 335mm W 110mm connection M4 tube ø 9.7mm connection distance 100mm		
For models:	A114001		

heating elements for heated cabinets

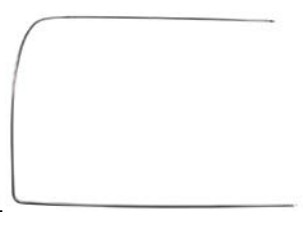

1

Part No.	418743	Ref. No.	040576
description	heating element 1200W 230V L 220mm W 680mm H 700mm heated cabinet		
For models:	103.122		



			
1			
Part No.	418741	Ref. No.	040827
description	heating element 400W 230V L 220mm W 350mm H 440mm heated cabinet		

			
1			
Part No.	418742	Ref. No.	040577
description	heating element 750W 230V L 220mm W 360mm H 690mm heated cabinet		
For models:	103063		

heating plates

			
1			
Part No.	419094	Ref. No.	A01204068
description	hot plate 1000W 230V ø 150mm with mounting thread for hot dog machine connection male faston 6.3mm		

			
1			
Part No.	419093	Ref. No.	020051028 020051028+0LY20051028+A01204066 A012040618
description	hot plate 800W 230V ø 125mm with thermostat t.max. 95°C for hot dog machine connection male faston 6.3mm		

quartz heating elements







			
1			
Part No.	420048	Ref. No.	A015160016
description	quartz heating element 340W 76V L 385mm ø 11mm connection eye for model A151.600		
For models:	A151600		

			
1			
Part No.	416858	Ref. No.	A030008462
description	quartz heating element 420W 115V L 380mm ø 10mm connection male faston 6.3mm		

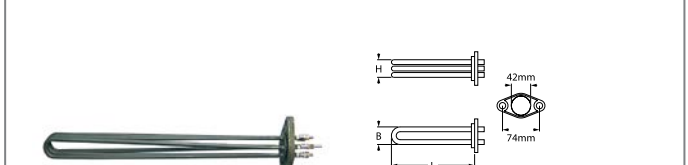
			
1			
Part No.	420047	Ref. No.	A041032
description	quartz heating element 425W 120V L 385mm ø 11mm connection eye for model A151.300		
For models:	A151300		

immersion heating elements





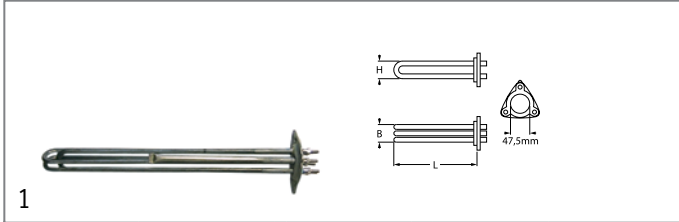

2 hole flange 74mm

				
1				
Part No.	415190	Ref. No.	0481925928596	
description	heating element 6000W 230V mounting ø 42mm heating circuits 3 L 340mm W 34mm H 30mm hole distance 75mm hole ø 9mm connection M4 immersion heater 2 hole flange flange length 93mm flange width 57mm			
accessories for	415190			
	Part No.	521103	Ref. No.	—
	nut thread M4 H 3mm WS 7 brass Qty 20 pcs			
	Part No.	521104	Ref. No.	—
	washer ID ø 4.3mm ED ø 8mm thickness 0.5mm brass Qty 20 pcs for thread M4			
	Part No.	521124	Ref. No.	0481946669609
	flat gasket rubber ED ø 52mm ID ø 42mm thickness 6mm Qty 1 pcs			
	Part No.	550444	Ref. No.	—
	protection cap ø 47mm H 40mm			
	Part No.	560111	Ref. No.	—
	plain washer ID ø 4.3mm ED ø 9mm thickness 0.8mm SS Qty 20 pcs DIN 125A for thread M4			
	Part No.	560131	Ref. No.	—
	hexagonal nut thread M4 H 3.2mm WS 7 SS DIN/ISO DIN 934 / ISO 4032/8673 Qty 20 pcs			





3 hole flange ø47.5mm



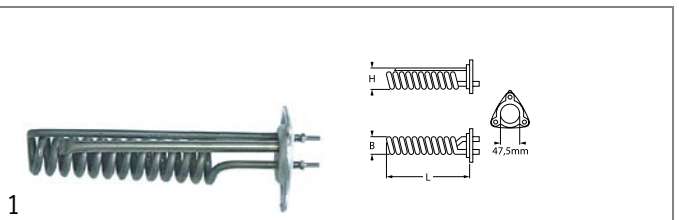

Part No.	415001	Ref. No.	0230081
description	heating element 4500W 230V mounting ø 47.5mm heating circuits 3 L 316mm W 35mm H 34mm number of thermostat sleeves 1 thermostat sleeves ø 7mm length thermostat sleeves 180mm thermostat sleeve eccentric, non clinging tube ø 6.3mm hole distance 62mm hole ø 8mm connection M4 3 hole flange immersion heater		
spare parts for	415001		
	Part No.	510408	Ref. No. 011510 011620
	O-ring EPDM thickness 5.34mm ID ø 47mm Qty 1 pcs		
accessories for	415001		
	Part No.	510562	Ref. No. —
	O-ring silicone thickness 5.34mm ID ø 47mm Qty 1 pcs		
	Part No.	521103	Ref. No. —
	nut thread M4 H 3mm WS 7 brass Qty 20 pcs		
	Part No.	521104	Ref. No. —
	washer ID ø 4.3mm ED ø 8mm thickness 0.5mm brass Qty 20 pcs for thread M4		
	Part No.	560111	Ref. No. —
	plain washer ID ø 4.3mm ED ø 9mm thickness 0.8mm SS Qty 20 pcs DIN 125A for thread M4		
	Part No.	560131	Ref. No. —
	hexagonal nut thread M4 H 3.2mm WS 7 SS DIN/ISO DIN 934 / ISO 4032/8673 Qty 20 pcs		



Part No.	415668	Ref. No.	0230090
description	heating element 2625W 230V mounting ø 47.5mm heating circuits 1 L 190mm W 41mm H 54mm number of thermostat sleeves 1 thermostat sleeves ø 7mm length thermostat sleeves 170mm thermostat sleeve eccentric, non clinging tube ø 6.3mm hole distance 62mm hole ø 8mm connection M4 3 hole flange immersion heater		
spare parts for	415668		
	Part No.	510408	Ref. No. 011510 011620
	O-ring EPDM thickness 5.34mm ID ø 47mm Qty 1 pcs		
accessories for	415668		
	Part No.	510562	Ref. No. —
	O-ring silicone thickness 5.34mm ID ø 47mm Qty 1 pcs		

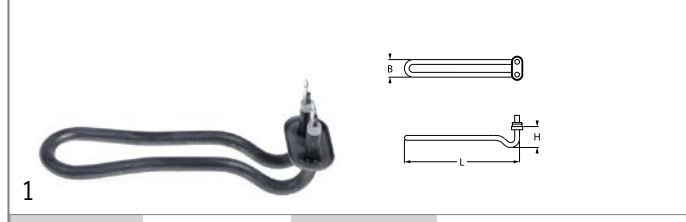





with compression flange 50 x 26mm









Part No.	416234	Ref. No.	0230098
description	heating element 600W 230V heating circuits 1 flange 50x26mm L 160mm W 45mm H 27mm tube ø 8.8mm connection male faston 6.3mm connection length 40mm immersion heater compression flange		
accessories for	416234		
	Part No.	510387	Ref. No. —
	gasket L 46mm W 22mm ømm EPDM for heating element for flange 50x26mm		
	Part No.	510388	Ref. No. —
	counterflange ømm hole distancemm perforation ømm L 43mm W 21mm SS for heating element for flange 50x26mm		









1 1/4"









Part No.	415005	Ref. No.	012290
description	heating element 2000W 230V heating circuits 1 thread 1 1/4" L 170mm W 32mm H 22mm tube ø 6.2mm connection M4		
accessories for	415005		
	Part No.	510405	Ref. No. 012291
	flat gasket fibre ED ø 56mm ID ø 42mm thickness 2mm for thread 1 1/4" Qty 1 pcs		
	Part No.	520232	Ref. No. —
	nut thread 1 1/4" H 5mm nickel-plated brass WS 47 Qty 1 pcs		
	Part No.	521103	Ref. No. —
	nut thread M4 H 3mm WS 7 brass Qty 20 pcs		
	Part No.	521104	Ref. No. —
	washer ID ø 4.3mm ED ø 8mm thickness 0.5mm brass Qty 20 pcs for thread M4		
	Part No.	528021	Ref. No. —
	flat gasket PTFE ED ø 53mm ID ø 42.5mm thickness 3mm Qty 1 pcs equiv. no. 12001/02286 suitable for Astoria/Aurora/Brasilia/Wega		
	Part No.	560111	Ref. No. —
	plain washer ID ø 4.3mm ED ø 9mm thickness 0.8mm SS Qty 20 pcs DIN 125A for thread M4		
	Part No.	560131	Ref. No. —
	hexagonal nut thread M4 H 3.2mm WS 7 SS DIN/ISO DIN 934 / ISO 4032/8673 Qty 20 pcs		



			
1			
Part No.	415664	Ref. No.	011598
description	heating element 2250W 230V heating circuits 1 L 300mm W 90mm H 25mm thread 1/8" mounting distance 64mm tube ø 6.3mm connection M4 immersion heater 2 hole fixing		
accessories for	415664		
	Part No.	510893	Ref. No. —
	O-ring EPDM thickness 2.62mm ID ø 9.92mm Qty 1 pcs		
	Part No.	521103	Ref. No. —
	nut thread M4 H 3mm WS 7 brass Qty 20 pcs		
	Part No.	521104	Ref. No. —
	washer ID ø 4.3mm ED ø 8mm thickness 0.5mm brass Qty 20 pcs for thread M4		
	Part No.	521129	Ref. No. —
	nut thread M10 H 6mm SS WS 17 Qty 1 pcs DIN/ISO DIN 439		
	Part No.	560111	Ref. No. —
	plain washer ID ø 4.3mm ED ø 9mm thickness 0.8mm SS Qty 20 pcs DIN 125A for thread M4		
	Part No.	560131	Ref. No. —
	hexagonal nut thread M4 H 3.2mm WS 7 SS DIN/ISO DIN 934 / ISO 4032/8673 Qty 20 pcs		

			
1			
Part No.	415665	Ref. No.	017677 0230060
description	heating element 2750/3250W 220/240V heating circuits 1 L 380mm W 110mm H 30mm thread M10x1 mounting distance 75mm tube ø 6.5mm connection M4 immersion heater 2 hole fixing		
spare parts for	415665		
	Part No.	510893	Ref. No. —
	O-ring EPDM thickness 2.62mm ID ø 9.92mm Qty 1 pcs		
accessories for	415665		
	Part No.	510416	Ref. No. —
	flat gasket fibre ED ø 19mm ID ø 10.5mm thickness 1.5mm for thread M10 Qty 1 pcs		
	Part No.	520231	Ref. No. —
	nut thread M10x1 H 6mm WS 14 zinc-coated steel Qty 1 pcs		
	Part No.	521103	Ref. No. —
	nut thread M4 H 3mm WS 7 brass Qty 20 pcs		
	Part No.	521104	Ref. No. —
	washer ID ø 4.3mm ED ø 8mm thickness 0.5mm brass Qty 20 pcs for thread M4		
	Part No.	521129	Ref. No. —
	nut thread M10 H 6mm SS WS 17 Qty 1 pcs DIN/ISO DIN 439		
	Part No.	560111	Ref. No. —
	plain washer ID ø 4.3mm ED ø 9mm thickness 0.8mm SS Qty 20 pcs DIN 125A for thread M4		

accessories for	415665		
	Part No.	560131	Ref. No. —
	hexagonal nut thread M4 H 3.2mm WS 7 SS DIN/ISO DIN 934 / ISO 4032/8673 Qty 20 pcs		

			
1			
Part No.	416235	Ref. No.	080360
description	heating element 3000W 230V heating circuits 1 L 320mm W 50mm H 40mm thread M10x1 mounting distance 44mm tube ø 6.3mm connection male faston 6.3mm 2 hole fixing L1 32mm L2 288mm		
spare parts for	416235		
	Part No.	510893	Ref. No. —
	O-ring EPDM thickness 2.62mm ID ø 9.92mm Qty 1 pcs		
accessories for	416235		
	Part No.	510416	Ref. No. —
	flat gasket fibre ED ø 19mm ID ø 10.5mm thickness 1.5mm for thread M10 Qty 1 pcs		
	Part No.	510893	Ref. No. —
	O-ring EPDM thickness 2.62mm ID ø 9.92mm Qty 1 pcs		
	Part No.	521129	Ref. No. —
	nut thread M10 H 6mm SS WS 17 Qty 1 pcs DIN/ISO DIN 439		
	Part No.	560192	Ref. No. —
	tooth lock washer ID ø 10.4mm ED ø 18mm SS DIN/ISO DIN 6798A Qty 1 pcs for thread M10		

heating elements for convection

			
1			
Part No.	420038	Ref. No.	A0YXD1A4A16
description	heating element 1260W 230V heating circuits 1 ID ø 181mm ED ø 193mm L 240mm H 29mm L1 39mm W1 30mm H1 12mm H2 17mm flange length 70mm flange width 22mm hole distance 56mm connection male faston 6.3mm tube ø 6.6mm hole ø 6mm		
For models:	A120788		





1

Part No.	416850	Ref. No.	030008381
description	heating element 1260W 230V heating circuits 1 ID ø 182mm ED ø 194mm L 252mm H 30mm L1 48mm W1 30mm H1 10mm H2 20mm flange length 70mm flange width 22mm hole distance 56mm connection male faston 6.3mm tube ø 6.3mm convection heating element hole ø 5mm rectangular flange		
accessories for	416850		
	Part No.	510368	Ref. No. 02005174
	gasket L 70mm W 23.5mm hole ø 5mm hole distance 56mm FIBER thickness 2mm for heating element		



1

Part No.	416852	Ref. No.	030008461
description	heating element 2500W 220V heating circuits 1 ID ø 183mm ED ø 195mm L 240mm H 26mm L1 45mm W1 31mm H1 6mm H2 20mm flange length 70mm flange width 22mm hole distance 56mm connection male faston 6.3mm tube ø 6.5mm convection heating element hole ø 5mm rectangular flange		
spare parts for	416852		
	Part No.	510368	Ref. No. 02005174
	gasket L 70mm W 23.5mm hole ø 5mm hole distance 56mm FIBER thickness 2mm for heating element		





1

Part No.	416851	Ref. No.	A030008458
description	heating element 1600W 230V heating circuits 1 ID ø 183mm ED ø 195mm L 250mm H 51mm L1 47mm W1 32mm H1 15mm H2 36mm flange length 70mm flange width 22mm hole distance 56mm connection male faston 6.3mm tube ø 6.3mm convection heating element hole ø 5mm rectangular flange		
accessories for	416851		
	Part No.	510368	Ref. No. 02005174
	gasket L 70mm W 23.5mm hole ø 5mm hole distance 56mm FIBER thickness 2mm for heating element		



1

Part No.	415966	Ref. No.	ORES006
description	heating element 2500W 230V heating circuits 1 ID ø 176mm ED ø 188mm L 210mm H 28mm L1 22mm W1 30mm H1 3mm H2 25mm flange length 70mm flange width 22mm hole distance 56mm connection male faston 6.3mm tube ø 6.3mm convection heating element hole ø 5mm rectangular flange		
spare parts for	415966		
	Part No.	510368	Ref. No. 02005174
	gasket L 70mm W 23.5mm hole ø 5mm hole distance 56mm FIBER thickness 2mm for heating element		
accessories for	415966		
	Part No.	510368	Ref. No. 02005174
	gasket L 70mm W 23.5mm hole ø 5mm hole distance 56mm FIBER thickness 2mm for heating element		



1

Part No.	418936	Ref. No.	06539168
description	heating element 1700W 240V heating circuits 1 ID ø 176mm ED ø 190mm L 248mm H 34mm L1 58mm W1 31mm H1 12mm H2 22mm flange length 70mm flange width 22mm hole distance 56mm connection male faston 6.3mm connection length 55mm tube ø 6.3mm convection heating element hole ø 5mm rectangular flange		



1

Part No.	418935	Ref. No.	06527752
description	heating element 2650W 240V heating circuits 1 ID ø 201mm ED ø 218mm L 252mm H 36mm L1 28mm W1 31mm H1 9mm H2 27mm flange length 70mm flange width 23mm hole distance 56mm connection male faston 6.3mm connection length 38mm tube ø 6.3mm convection heating element hole ø 5mm rectangular flange		



1

Part No.	420534	Ref. No.	ORES015
description	heating element 2000W 240V heating circuits 2 ID ø 220mm ED ø 233mm L 270mm H 44mm L1 16mm W1 58mm H1 14mm H2 30mm flange length 100mm flange width 22mm connection F6.3 tube ø 6.5mm threaded		



1			
Part No.	417607	Ref. No.	0RES000
description	heating element 2x2000W 230V heating circuits 2 ID ø 185mm ED ø 200mm L 240mm H 50mm L1 40mm W1 63mm H1 15mm H2 35mm flange length 100mm flange width 22mm hole distance 85mm connection male faston 6.3mm tube ø 6.4mm hot air hole ø 4.9mm		
accessories for	417607		
	Part No.	550986	Ref. No. —
	gasket L 100mm W 22mm 7 holes graphite thickness 1mm for heating element		

1			
Part No.	419004	Ref. No.	010578052
description	heating element 3100W 230V heating circuits 1 ID ø 223mm ED ø 239mm L 260mm H 60mm L1 20mm W1 23mm H1 20mm H2 40mm flange length 100mm flange width 22mm hole distance 86mm connection M4 tube ø 6.3mm hole ø 5.2mm		
For models:	105780		

1			
Part No.	417606	Ref. No.	0RES026
description	heating element 4500W 230V heating circuits 3 ID ø 220mm ED ø 240mm L 280mm H 50mm L1 1mm W1 96mm H1 15mm H2 35mm flange length 140mm flange width 25mm hole distance 63mm connection male faston 6.3mm connection length 41.5mm tube ø 8.4mm hot air hole ø 7mm		

radiation heaters

1			
Part No.	416001	Ref. No.	027676
description	radiation heater rectangular 1500W 230/240V L 265mm W 165mm H 32mm heating circuits 1 connections 2 connection type cable cable length 700mm EGO salamander grill		
accessories for	416001		
	Part No.	390880	Ref. No. 027677
	safety rod thermostat switch-off temp. 780°C temperature range°C 2-pole 1NC/1NOA probe ø 4mm probe L 170mm capillary pipemm capillary pipe isolatedmm gland nut shaft ømm		
	Part No.	403523	Ref. No. —
	solid state relay ANLY 1 phase 40A 24-280V 4-32VDC L 47.5mm W 43mm screw type ASR-40DA		

hot plates

square & rectangular

with radiused edge

1			
Part No.	490068 ¹	Ref. No.	01122454238
description	hot plate dimensions 220x220mm 2600W 400V with spill ring connection 4 screw clamps protector yes square		

¹incl. protector

1			
Part No.	490057 ¹	Ref. No.	016726
description	hot plate dimensions 300x300mm 3000W 400V with spill ring connection 4 screw clamps protector yes square		

¹incl. protector



round

with radiused edge

for domestic and commercial kitchens



1

Part No.	490014	Ref. No.	017797
description	hot plate ø 180mm 1500W 230V connection 4 screw clamps with 8mm spill ring		



1

Part No.	490020	Ref. No.	028010
description	hot plate ø 220mm 2600W 230V connection 4 screw clamps with 8mm spill ring		
accessories for	490020		
	Part No.	550796	Ref. No.
			—
	fixing plate for hot plate ø220mm		

energy regulators

EGO

1-circuit



1

Part No.	380009	Ref. No.	A0106041
description	energy regulator 230V 13A single-circuit turn direction left shaft ø 6x4.6mm mounting thread M4 no. 50.57020.010		



1

Part No.	380015	Ref. No.	05057021010
description	energy regulator 230V 13A single-circuit turn direction right shaft ø 6x4.6mm shaft L 23mm mounting thread M4 power release 6-100% no. 50.57021.010		
For models:	151510		

DIAMOND



1

Part No.	380032	Ref. No.	EB-600-08
description	energy regulator 230V 13.5A turn direction right shaft ø 6x4.6mm shaft L 23mm mounting thread M4 equiv. no. 45ER104C1		

thermostats

bi-metal thermostats

safety bi-metal thermostats



1

Part No.	390100	Ref. No.	A017405
description	bi-metal safety thermostat hole distance 23.5mm switch-off temp. 110°C 1NC 1-pole 16A connection F6.3 mounting ø 16mm		



1

Part No.	390708	Ref. No.	A039889
description	bi-metal safety thermostat hole distance 23.5mm switch-off temp. 180°C 1NC 1-pole 16A connection M3 mounting ø 15mm		
For models:	A150671, A150674		



1

Part No.	390379	Ref. No.	A040625
description	bi-metal safety thermostat hole distance 23.5mm switch-off temp. 150°C 1NC 1-pole 16A connection F6.3		
For models:	A190141, A190161, REGINA90 A190192		
accessories for	390379		
	Part No.	550389	Ref. No.
			—
	bracket for contact thermostat		



bi-metal thermostats



1

Part No.	390319	Ref. No.	236048
description	bi-metal thermostat hole distance 23.8mm switch-off temp. 80°C 1NC 1-pole 16A connection F6.3 2 hole fixing		



1

Part No.	390753	Ref. No.	AOND013
description	bi-metal thermostat hole distance 24mm switch-off temp. 83°C 1NC 1-pole 16A 250V connection F6.3 2 hole fixing for coffee machine		
For models:	A190141, A190161		



1

Part No.	390955	Ref. No.	A037165
description	thermostat hole distance 23.5mm switch-off temp. 73°C 1NC 1-pole 10A connection F6.3		
For models:	REGINA90 A190192		

control and safety thermostats

EGO

control thermostats

51._ series



1

Part No.	375261	Ref. No.	0104231
description	thermostat t.max. 190°C temperature range 94-190°C 1-pole 1NO 15A probe ø 6mm probe L 133mm capillary pipe 890mm capillary pipe isolated 700mm gland nut M10x1 shaft L 23mm shaft position upper rotation 318°		

E-G-O



1

Part No.	390306	Ref. No.	0236027
description	thermostat t.max. 85°C temperature range fixed 85°C 1-pole gland nut		

55.10/19_ series

E-G-O



1

Part No.	375002	Ref. No.	A010401
description	thermostat t.max. 320°C temperature range 55-320°C 1-pole 1NO 16A probe ø 3.1mm probe L 226mm capillary pipe 870mm capillary pipe isolated 850mm gland nut shaft L 23mm shaft position upper rotation 270°		

E-G-O



1

Part No.	390416	Ref. No.	0481927128594
description	thermostat t.max. 85°C temperature range fixed 85°C 1-pole 1CO 16A probe ø 6mm probe L 129mm capillary pipe 1470mm capillary pipe isolated 1430mm gland nut shaft Lmm shaft position		



55.13_ series



1

Part No.	390719	Ref. No.	A02030935
description	thermostat t.max. 110°C temperature range 30-110°C 1-pole 1NO 16A probe ø 6mm probe L 115mm capillary pipe 830mm capillary pipe isolatedmm gland nut shaft ø 6x4.6mm shaft L 23mm shaft position left rotation 270°		
For models:	A203093		



1

Part No.	375705	Ref. No.	06528193
description	thermostat t.max. 110°C temperature range 30-110°C 1-pole 1NO 16A probe ø 6mm probe L 115mm capillary pipe 1430mm capillary pipe isolatedmm gland nut M9x1 shaft ø 6x4.6mm shaft L 23mm shaft position upper rotation 270°		



1

Part No.	375788	Ref. No.	021899
description	thermostat t.max. 175°C temperature range 101-175°C 1-pole 1NO 16A probe ø 6mm probe L 98mm capillary pipe 870mm capillary pipe isolated 800mm gland nut shaft ø 6x4.6mm shaft L 23mm shaft position upper rotation 270°		



1

Part No.	375517	Ref. No.	A039882	
description	thermostat t.max. 190°C temperature range 60-190°C 1-pole 1NO 16A probe ø 6mm probe L 77mm capillary pipe 870mm capillary pipe isolatedmm gland nut shaft ø 6/4.6mm shaft L 23mm shaft position left ° rotation 270°			
For models:	A150107, A150207			
accessories for	375517			
	Part No.	512205	Ref. No.	016240433



1

Part No.	375492	Ref. No.	014231
description	thermostat t.max. 190°C temperature range 94-190°C 1-pole 1NO 16A probe ø 6mm probe L 94mm capillary pipe 1090mm capillary pipe isolated 960mm gland nut M10x1 shaft ø 6x4.6mm shaft L 23mm shaft position upper rotation 310° probe material SS		



1

Part No.	375615	Ref. No.	0KG20509
description	thermostat t.max. 200°C temperature range 68-200°C 1-pole 1NO 16A probe ø 6mm probe L 78mm capillary pipe 870mm capillary pipe isolatedmm gland nut shaft ø 6x4.6mm shaft L 25mm shaft position left° rotation 270° probe material SS		
For models:	A203094		

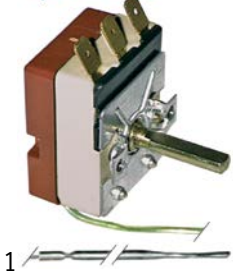

Part No.	375087	Ref. No.	06553670
description	thermostat t.max. 300°C temperature range 50-300°C 1-pole 1CO 16A probe ø 3.03mm probe L 160mm capillary pipe 1130mm capillary pipe isolated 1103mm gland nut shaft L 23mm shaft position upper rotation 270°		



Part No.	375505	Ref. No.	01044465 030008099 A039884
description	thermostat t.max. 320°C temperature range 50-320°C 1-pole 1NO 16A probe ø 3mm probe L 160mm capillary pipe 870mm capillary pipe isolatedmm gland nut shaft ø 6x4.6mm shaft L 23mm shaft position upper rotation 270°		
For models:	104447, A150671, A150674		

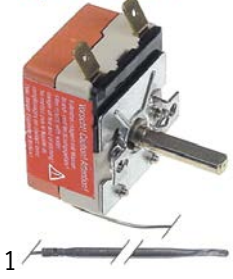

Part No.	375530	Ref. No.	029154
description	thermostat t.max. 400°C temperature range 100-400°C 1-pole 1NO 16A probe ø 3.9mm probe L 163mm capillary pipe 830mm capillary pipe isolatedmm gland nut shaft ø 6x4.6mm shaft L 23mm shaft position upper rotation 270°		

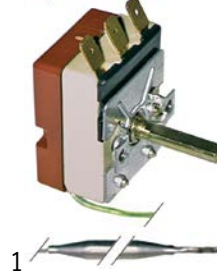

Part No.	375006	Ref. No.	040575
description	thermostat t.max. 85°C temperature range 30-85°C 1-pole 1CO 16A probe ø 6mm probe L 92mm capillary pipe 3150mm capillary pipe isolated 300mm gland nut shaft L 23mm shaft position upper rotation 270° probe material SS		
For models:	103.122, 103063		

55.14_ series

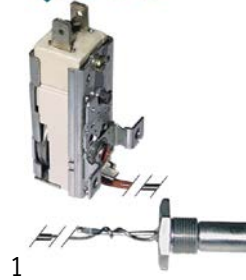

Part No.	390001	Ref. No.	022823 0236023
description	thermostat t.max. 58°C temperature range fixed 58°C 1-pole 1NC 16A probe ø 11mm probe L 35mm capillary pipe 580mm capillary pipe isolated 580mm gland nut shaft Lmm shaft position° shaft position screw-in probe probe thread M14x1		

accessories for	390001			
	Part No.	510417	Ref. No.	—
	flat gasket fibre ED ø 20mm ID ø 14mm thickness 2mm Qty 1 pcs			
	Part No.	550261	Ref. No.	—
	nut thread M14x1 H 4mm WS 19 SS Qty 1 pcs			

55.18_ series

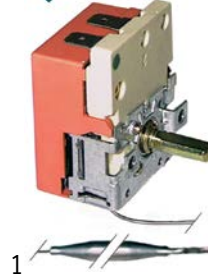

Part No.	375110	Ref. No.	A010502
description	thermostat t.max. 190°C temperature range 121-190°C 1-pole 1NC 16A probe ø 6mm probe L 117mm capillary pipe 390mm capillary pipe isolatedmm gland nut shaft ø 6x4.6mm shaft L 15mm shaft position left rotation 270° probe material SS		



55.34_ series



Part No.	375385	Ref. No.	023964
description	thermostat t.max. 180°C temperature range 100-180°C 3-pole 3NO 16A probe ø 6mm probe L 131mm capillary pipe 2000mm capillary pipe isolated 1800mm gland nut shaft ø 6x4.6mm shaft L 23mm shaft position upper rotation 270°		

55.13_ series



Part No.	375830	Ref. No.	020411
description	safety thermostat switch-off temp. 365°C 1-pole 1NC 16A probe ø 3mm probe L 160mm capillary pipe 1730mm capillary pipe isolated 1710mm gland nut probe		



Part No.	375412	Ref. No.	016728
description	thermostat t.max. 320°C temperature range 50-320°C 3-pole 3NO 16A probe ø 3.1mm probe L 226mm capillary pipe 1480mm capillary pipe isolated 1400mm gland nut shaft ø 6x4.6mm shaft L 23mm shaft position upper rotation 318°		

55.32_ series

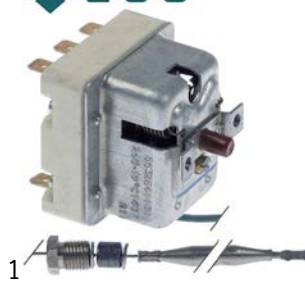

Part No.	390813	Ref. No.	049050
description	safety thermostat switch-off temp. 245°C 3-pole 20A probe ø 6mm probe L 78mm capillary pipe 1500mm capillary pipe isolated 1050mm gland nut M9x1 probe		

safety thermostats

55.11_ series

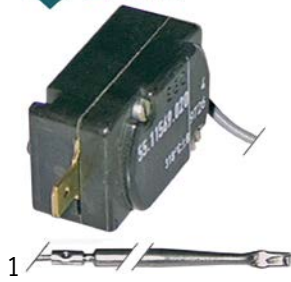

Part No.	375109	Ref. No.	A010501
description	safety thermostat switch-off temp. 240°C 1-pole 16A probe ø 4mm probe L 91mm capillary pipe 530mm capillary pipe isolated 350mm gland nut probe SS		

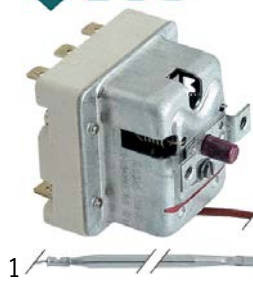

Part No.	375312	Ref. No.	023965	
description	safety thermostat switch-off temp. 245°C 3-pole 3NC 20A probe ø 4mm probe L 120mm capillary pipe 1800mm capillary pipe isolated 1800mm gland nut probe SS			
accessories for	375312			
	Part No.	550981	Ref. No.	—
	probe clip for pipe ø 8.5mm for probe ø 6mm for heating elements spacing 0.4mm Qty 1 pcs			



55.33_ series



Part No.	375796	Ref. No.	06537879
description	safety thermostat switch-off temp. 220°C 3-pole 3NC 20A probe ø 6mm probe L 107mm capillary pipe 870mm capillary pipe isolated 800mm gland nut probe		

control thermostats with operation switch

55.10/19_ series



Part No.	390052	Ref. No.	049672
description	thermostat t.max. 185°C temperature range 90-185°C 1-pole 1NO 15A probe ø 4mm probe L 229mm capillary pipe 2500mm capillary pipe isolated 1200/200mm gland nut shaft ø 6x4.6mm shaft L 25mm shaft position upper* rotation 270° outer switch 2NO		

IMIT / TEMPOMATIC / ARTHERMO

control thermostats



Part No.	390421	Ref. No.	0236043
description	thermostat t.max. 85°C temperature range 0-90°C 1-pole 1CO 16A probe ø 6.5mm probe L 95mm capillary pipe 1500mm capillary pipe isolated 1450mm gland nut shaft ømm shaft Lmm shaft position rotation 270° probe material copper		

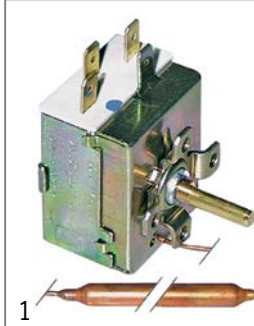

Part No.	390006	Ref. No.	0929044	
description	thermostat t.max. 86°C temperature range 0-86°C 1-pole 1CO 16A probe ø 6.5mm probe L 95mm capillary pipe 1500mm capillary pipe isolatedmm gland nut shaft ø 6x4.6mm shaft L 19mm rotation 270°			
accessories for	390006			
	Part No.	110100	Ref. No.	—
	knob thermostat t.max. 90°C 0-90°C ø 42mm shaft ø 6x4.6mm shaft flat -135° black			
	Part No.	110105	Ref. No.	—
	rosette knob ø 42mm ø 56mm zero mark			

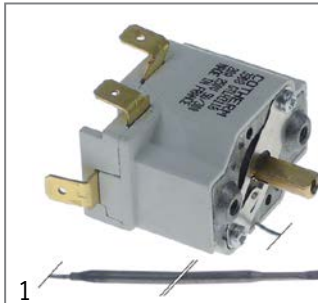

Part No.	390718	Ref. No.	A0YXD1A4A11
description	thermostat temperature range 50-300°C 1-pole 1NO 20A probe ø 3mm probe L 190mm capillary pipe 900mm shaft ø 6x4.6mm shaft L 12.5mm shaft position upper rotation 270° 250V		
For models:	105780, A120788		

CAEM

control thermostats



Part No.	390602	Ref. No.	A0402503000
description	thermostat t.max. 300°C temperature range 50-300°C 1-pole 1NO 16A probe ø 5mm probe L 70mm capillary pipe 900mm capillary pipe isolated 700mm gland nut shaft L 18mm rotation 270°		



			
1			
Part No.	375419	Ref. No.	A030008288
description	thermostat t.max. 300°C temperature range 50-300°C 1-pole 1N0 16A probe ø 5mm probe L 90mm capillary pipe 890mm rotation 270°		

safety thermostats

			
1			
Part No.	376029	Ref. No.	TER008
description	safety thermostat switch-off temp. 320°C temperature range°C 1-pole 1NC 20A probe ø 3mm probe L 165mm capillary pipe 1280mm capillary pipe isolated 1080mm gland nut shaft ømm probe SS 250V		

			
1			
Part No.	375990	Ref. No.	OTER035 OTER325 TER002 TER008 old
description	safety thermostat switch-off temp. 335°C 1-pole 16A probe ø 3mm probe L 180mm capillary pipe 1400mm capillary pipe isolatedmm gland nut M10x1 probe SS		

PRODIGY / FIRT

safety thermostats

			
1			
Part No.	375478	Ref. No.	0927106
description	safety thermostat switch-off temp. 200°C temperature range°C 1-pole 1CO 20A probe ø 3.3mm probe L 190mm capillary pipe 2150mm capillary pipe isolatedmm gland nut probe SS		

various

control thermostats

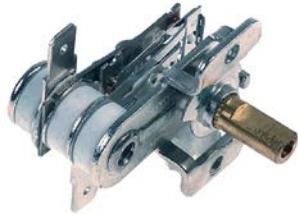
			
1			
Part No.	390623	Ref. No.	A02011002
description	thermostat for pizza oven		

			
1			
Part No.	376082	Ref. No.	020006332
description	thermostat t.max. 100°C 16A probe ø 6mm probe L 88mm capillary pipe 510mm capillary pipe isolated 160mm shaft ø 6x4.6mm shaft L 20mm rotation 270°		

			
1			
Part No.	390622	Ref. No.	01143566
description	thermostat t.max.°C temperature range°C 1-pole 1NC 10A probe ømm probe Lmm capillary pipemm capillary pipe isolatedmm gland nut shaft ø 6x4.6mm shaft L 30mm shaft position upper rotation 315° for heated cabinet		

safety thermostats

			
1			
Part No.	375523	Ref. No.	016240438 A039891
description	safety thermostat switch-off temp. 230°C 1-pole 1NC 16A probe ø 4mm probe L 100mm capillary pipe 900mm capillary pipe isolated 410mm gland nut probe		
For models:	A150107, A150207		



			
1			
Part No.	390720	Ref. No.	A0YXD4A26
description	thermostat switch-off temp. 320°C 1-pole 1NC 16A probe ø 5mm probe L 57mm capillary pipe 870mm capillary pipe isolated 45mm screw connection M10x1		
For models:	105780, A120788		

rod thermostats

safety rod thermostats

			
1			
Part No.	390880	Ref. No.	027677
description	safety rod thermostat switch-off temp. 780°C temperature range°C 2-pole 1NC/1NOA probe ø 4mm probe L 170mm capillary pipemm capillary pipe isolatedmm gland nut shaft ømm		

refrigeration thermostats

miscellaneous producers

			
1			
Part No.	390481	Ref. No.	030008404
description	thermostat		

accessories

probe clips

clamps

for thermostat



			
1			
Part No.	692185	Ref. No.	016210821
description	probe clip for probe ø 6mm SS Qty 1 pcs L 40mm W 14mm		

			
1			
Part No.	692184	Ref. No.	016240410
description	probe clip for probe ø 6mm SS Qty 1 pcs L 57mm W 20mm		



switches and momentary switches

rocker/momentary rocker switches

30x11mm

			
1			
Part No.	301010	Ref. No.	A0ND021
description	rocker switch mounting measurements 30x11mm red 1NO/indicator light 250V 16A 0-I connection male faston 6.3mm ambient temperature max. 85/125°C protection IP40		
For models:	A190141, A190161		
accessories for	301010		
	Part No.	301035	Ref. No. —
protective cover mounting measurements 30x11mm			

			
1			
Part No.	301038	Ref. No.	01143568
description	rocker switch mounting measurements 30x11mm green 1NO/indicator light 250V 16A connection male faston 6.3mm		



			
1			
Part No.	346890	Ref. No.	SL0758
description	rocker switch mounting measurements 30x11mm black 1CO 250V 16A I-II connection male faston 6.3mm ambient temperature max. 85°C/145°C protection IP65 with cover cap		
accessories for	346890		
	Part No.	301035	Ref. No. —
protective cover mounting measurements 30x11mm			

30x22mm



			
1			
Part No.	347791	Ref. No.	A040573
description	rocker switch mounting measurements 30x22mm green 2NO 230V 20A illuminated 0-I connection male faston 6.3mm ambient temperature max. 125/55°C protection IP65 with rubber collar		



			
1			
Part No.	347531	Ref. No.	016210836
description	rocker switch mounting measurements 30x22mm green 2NO 250V 20A illuminated 0-I connection male faston 6.3mm ambient temperature max. 125/55°C protection IP65 with rubber collar		

			
1			
Part No.	301062	Ref. No.	06540129
description	rocker switch mounting measurements 30x22mm green 2NO 250V 16A illuminated connection male faston 6.3mm ambient temperature max. 100/55°C protection IP40		
accessories for	301062		
	Part No.	301036	Ref. No.
			—
	 protective cover internal size 30x22mm for rocker switch mounting measurementsmm		

			
1			
Part No.	301101	Ref. No.	030008385
description	rocker switch mounting measurements 30x22mm white 2CO 250V 16A connection male faston 6.3mm ambient temperature max. 100/55°C protection IP40		

blank			
			
1			
Part No.	301005	Ref. No.	A017615
description	rocker switch mounting measurements 30x22mm red 2NO 250V 16A illuminated connection male faston 6.3mm ambient temperature max. 125/55°C protection IP65 with protecting cover		
accessories for	301005		
	Part No.	301036	Ref. No.
			—
	 protective cover internal size 30x22mm for rocker switch mounting measurementsmm		

push/momentary push switches

ø16mm			
			
1			
Part No.	347363	Ref. No.	A038978
description	momentary push switch mounting ø 16mm black 1NO 250V 3A connection male faston 4.8mm ambient temperature max. 85°C protection IP40		
For models:	105780, A120788		

ø25mm			
			
1			
Part No.	348211	Ref. No.	016148
description	push switch mounting ø 25mm red 1NO/indicator light 250V 16A illuminated connection male faston 6.3mm ambient temperature max. 85°C protection IP65 with cover		

overload switches			
			
1			
Part No.	348137	Ref. No.	017319526
description	push switch KLD-28A mounting measurements 45x22mm green/red 2NO/A1 250V 16A I O connection male faston 2.8mm/6.3mm ambient temperature max. 85°C protection IP55 with cover cap		

toggle switches

M12x1			
			
1			
Part No.	347340	Ref. No.	A01140013
description	toggle switch thread M12x1 1NO 250V 15A ON-OFF screw		
For models:	A114001		

microswitches

lever actuated			
			
1			
Part No.	345049	Ref. No.	011505 011644 012273
description	microswitch with lever CO connection male faston		

pin-plunger actuated

			
1			
Part No.	345060	Ref. No.	A0800045
description	microswitch with plunger 250V 16A 1NO connection male faston 6.3mm ambient temperature max. 85°C mounting distance 22mm type BS1010 actuating force: 350g red stroke 9mm		



M10



1

Part No.	347341	Ref. No.	016240435 A040031
description	microswitch with plunger thread M10x1 thread L 16mm 250V 10A 1NO connection male faston 6.3mm stroke 5mm mounting distance L 41mm ambient temperature max. 85°C type X3L502K6DD actuating force: 130g		
For models:	A150107, A150207		

M12



1

Part No.	345138	Ref. No.	010578032
description	microswitch with plunger mounting distance 25mm thread M12x1 thread L 12mm 250V 20A 1CO connection screw stroke 7mm L1 13mm ambient temperature max. 85°C type Z15G1307 actuating force: 250g		
For models:	105780		

system switches (ROLD)



1

Part No.	345606	Ref. No.	0226071
description	momentary switch unit 2CO 250V 16A connection male faston 6.3mm		



1

Part No.	345538	Ref. No.	0227050
description	push button ø 11.9mm black		

cam switches

4-position



1

Part No.	300094	Ref. No.	A010708
description	cam switch 4 operating positions 1NO/2CO sequence 0-1-2-3 16A shaft ø 6x4.6mm shaft L 15mm connection screw 4-position ceramic		

7-position



1

Part No.	300031	Ref. No.	06553435 A030008088
description	cam switch 7 operating positions 1NO/2CO sequence 0-1-2-3-4-5-6 16A shaft ø 6x4.6mm shaft L 23mm connection male faston 6.3mm 7-position plastic		

4 operating positions



1

Part No.	347366	Ref. No.	A040081
description	rotary switch 4 operating positions 2NO sequence 0-1-2-3 16A shaft ø 6x4.6mm shaft L 23mm connection male faston 6.3mm 250V A040081 sets of contacts 2 plastic for oven		
For models:	A151600		



operation switches

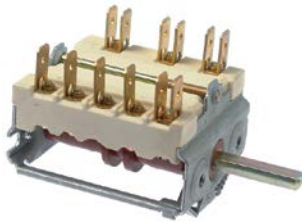

1			
Part No.	300209	Ref. No.	06552194
description	cam switch 5 operating positions operation switch 16A sequence 0-1-2-3-4 shaft \varnothing 6x4.6mm shaft L 23mm connection male faston ceramic 3-pole ambient temperature max. 330°C		

rotary switches

miscellaneous



1			
Part No.	347367	Ref. No.	A040080
description	rotary switch sets of contacts 2 4 0-1-2-3 type A040080 250V 16A shaft \varnothing 6x4.6mm shaft L 22.5mm with knob connection male faston 6.3mm for oven		
For models:	A151300		
accessories for	347367		
	Part No.	112626	Ref. No. A040082
	knob oven t.max.°C \varnothing 41mm shaft \varnothing 6x4.6mm shaft flat lower black		

magnetic switches

accessories

magnets

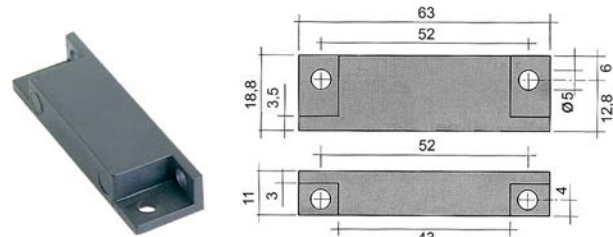

1			
Part No.	345336	Ref. No.	0926014
description	magnet \varnothing 4.8mm L 63mm H 11mm W 18.8mm hole distance 51mm M4		

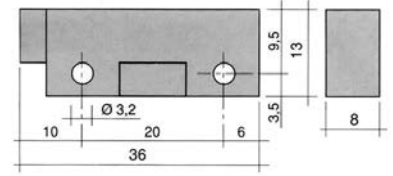

1			
Part No.	345398	Ref. No.	0217003
description	magnet \varnothing mm L 36mm H 8mm W 13mm hole distance 20mm M3 hole \varnothing 3mm		

lamps

indicator lights

indicator lamps for socket type SRZ / SDK / SDY / SFK



1			
Part No.	359130	Ref. No.	010426 0216006
description	indicator lamp 230V clear connection male faston 6.3mm \varnothing 8mm		

indicator lights (complete)

\varnothing 6mm



1			
Part No.	359031	Ref. No.	0216022
description	indicator light \varnothing 6mm 230V green		

\varnothing 9mm



1			
Part No.	359137	Ref. No.	021784
description	indicator light \varnothing 9mm 230V yellow connection male faston 6.3mm temp.-resist. 120°C with lens		

\varnothing 10mm

with screw socket



1			
Part No.	359870	Ref. No.	A0ND022
description	indicator light \varnothing 10mm 230V green connection male faston 4.8mm socket screw base		
For models:	A190141, A190161		





1			
Part No.	359872	Ref. No.	01143569
description	indicator light \varnothing 10mm 230V red connection male faston 4.8mm socket screw base		



			
1			
Part No.	359871	Ref. No.	A040380
description	indicator light ø 10mm 230V yellow connection male faston 4.8mm socket screw base		

with plug-in socket

			
1			
Part No.	359139	Ref. No.	0216019
description	indicator light ø 10mm green 230V connection male faston 6.3mm Qty 1 pcs		

			
1			
Part No.	359140	Ref. No.	0216018
description	indicator light ø 10mm yellow 230V connection male faston 6.3mm Qty 1 pcs		

			
1			
Part No.	359315	Ref. No.	A010403
description	indicator light ø 10mm 230V green cable length 250mm		

ø12mm

with plug-in socket

			
1			
Part No.	359846	Ref. No.	01044466 A039883 EB-600-09
description	indicator light ø 12mm green 230V connection male faston 6.3mm Sinus		
For models:	104447, 151510, A120788, A150107, A150207, A150671, A150674, A203094, EB600		

			
1			
Part No.	360509	Ref. No.	016240441 A039887 EB-600-06
description	indicator light ø 12mm yellow 230V connection male faston 6.3mm thermometer		
For models:	151510, A150107, A150207, A150671, A150674, EB600		



			
1			
Part No.	359571	Ref. No.	010578014
description	indicator light ø 13mm green 230V connection male faston 6.3mm steaming		
For models:	105780		

			
1			
Part No.	359570	Ref. No.	010578012
description	indicator light ø 13mm green 230V connection male faston 6.3mm temperature		
For models:	105780		

			
1			
Part No.	359572	Ref. No.	010578015
description	indicator light ø 13mm green 230V connection male faston 6.3mm timer		
For models:	105780		

ø13mm

with screw socket

			
1			
Part No.	359146	Ref. No.	06540106
description	indicator light ø 13mm 230V yellow		
accessories for	359146		
	Part No.	510302	Ref. No. —
	O-ring EPDM ID ø 12.42mm thickness 1.78mm Qty 1 pcs		
	Part No.	511505	Ref. No. —
	O-ring EPDM thickness 1.78mm ID ø 12.42mm Qty 10 pcs		

with plug-in socket

			
1			
Part No.	357010	Ref. No.	OAT93615 AOAT93615
description	indicator light ø 13mm green clock		
For models:	A1515001		



screw-on/push-on fit

light bulbs

for ovens



1

Part No.	359610	Ref. No.	014034 A0YXD1A4A10
description	light bulb t.max. 300°C socket E14 15W 230V ø 22mm L 47mm lens L 20mm for oven lamp type Philips		
For models:	105780, A120788		

halogen lamp

for socket G4 / G6.35 / G9



1

Part No.	359946	Ref. No.	A01140014
description	halogen lamp socket G9 230V 40W temp.-resist. 300°C		
For models:	A114001		

fluorescent lamps

accessories

sockets



1

Part No.	359662	Ref. No.	030008413
description	lamp socket for fluorescent lamps		

oven lamps

universal oven lamps

mounting diameter 35.5mm



1

Part No.	359718	Ref. No.	030003005+030008380 A0YXD1A4A12
description	oven lamp mounting ø 35.5mm 230V 15W socket E14 temp.-resist. 300°C connection male faston 6.3mm hard glas		
For models:	105780, A120788		
spare parts for	359718		
	Part No.	359701	Ref. No. —
	lamp socket socket E14 220-230V mounting ø 35.5mm connection male faston 6.3mm 15W		

spare parts for	359718		
	Part No.	359740	Ref. No. —
	light bulb t.max. 300°C socket E14 15W 230V ø 22mm L 48mm lens L 20mm for oven lamp IMPORT		

lamps

light bulbs



1

Part No.	359610	Ref. No.	014034 A0YXD1A4A10
description	light bulb t.max. 300°C socket E14 15W 230V ø 22mm L 47mm lens L 20mm for oven lamp type Philips		
For models:	105780, A120788		

halogen lamps

for socket G4 / G6.35 / G9



1

Part No.	359946	Ref. No.	A01140014
description	halogen lamp socket G9 230V 40W temp.-resist. 300°C		
For models:	A114001		

sockets

G9



1

Part No.	359742	Ref. No.	0200201013
description	lamp socket L 36mm mounting distance 28mm		
For models:	A114001		



timers

programme timers

1 electric components

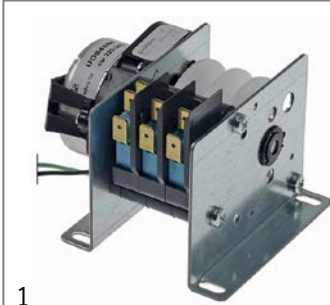

1

Part No.	360726	Ref. No.	OINV013 OINVER230
description	programme timer Guaitani R3/3 engines 1 chambers 3 operation time 6min 220/240V 50/60Hz shaft \varnothing 6x6mm shaft L 44mm manuf. no. R3/3 motor type UDS40NE1RNZ165		
spare parts for	360726		
	Part No.	360673	Ref. No. —
	motor kit pinion \varnothing 6.8mm teeth 15 230V voltage AC 50/60Hz turn direction clockwise motor \varnothing 48mm H 18.5mm motor type UDS-40NE1RNZ165 cable length 150mm with holder		



1

Part No.	360349	Ref. No.	018202 0238053
description	timer CDC 11803 engines 1 chambers 3 operation time 150s 230V shaft \varnothing mm shaft Lmm manuf. no. 11803F1BEE000.0010 motor type M48R ATS type 11803F1 / 238046		
spare parts for	360349		
	Part No.	360673	Ref. No. —
	motor kit pinion \varnothing 6.8mm teeth 15 230V voltage AC 50/60Hz turn direction clockwise motor \varnothing 48mm H 18.5mm motor type UDS-40NE1RNZ165 cable length 150mm with holder		



1

Part No.	400740	Ref. No.	A017610
description	timer		



1

Part No.	360413	Ref. No.	010578024
description	timer FIBER P19 engines 1 chambers 2 operation time 4min 230V 50Hz shaft \varnothing mm shaft Lmm		
For models:	105780		

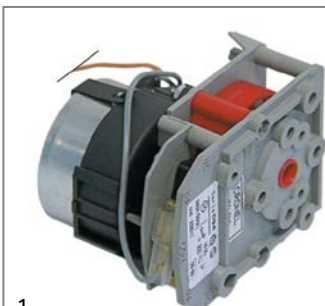

1

Part No.	360005	Ref. No.	012268 0238052
description	timer BIGATTI D94 engines 1 chambers 1 operation time 20min 230V shaft \varnothing mm shaft Lmm manuf. no. WE006 motor type 82354021L		

1

Part No.	360152	Ref. No.	A010701
description	timer with permanent position 2-pole NO for B1 operation time 120min		

electric timers

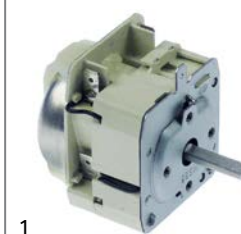



1

Part No.	350194	Ref. No.	OTIM000 OTIM060
description	timer MS65 with bell operation time 60min time spreadmin 2NO at 250V 16A permanent position yes impulse electric shaft \varnothing 6x4.6mm shaft L 23mm mounting distance 29mm mounting thread M4 connection male faston 6.3mm Invensys 230V voltage AC 2-pole		



mechanical timers

			
1			
Part No.	360470	Ref. No.	010578022
description	timer C53 2-pole operation time 120min impulse mechanical 1NO/1NC at 250V 16A permanent position yes shaft ø 6x4.6mm shaft 6x4.6mm shaft L 23mm mounting distance 28mm		
For models:	105780		

			
1			
Part No.	360475	Ref. No.	A0YXD1A4A06
description	timer M11 with bell 1-pole operation time 120min impulse mechanical 1NO at 250V 16A permanent position no shaft ø 6x4.6mm shaft 6x4.6mm shaft L 21mm mounting distance 28mm		
For models:	A120788		



											
1											
Part No.	360545 ¹	Ref. No.	A040900								
description	timer M11 with bell 1-pole operation time 15min 1NO at 250V 16A permanent position no shaft ø 6mm shaft 6mm shaft L 15mm mounting distance 28mm connection male faston 6.3mm with knob										
accessories for	360545										
		<table border="1"> <tr> <td>Part No.</td> <td>112624</td> <td>Ref. No.</td> <td>A040898</td> </tr> </table>	Part No.	112624	Ref. No.	A040898	<table border="1"> <tr> <td>Part No.</td> <td>112624</td> <td>Ref. No.</td> <td>A040898</td> </tr> </table>	Part No.	112624	Ref. No.	A040898
Part No.	112624	Ref. No.	A040898								
Part No.	112624	Ref. No.	A040898								
	knob time 15min t.max.°C ø 41mm shaft ø 6mm shaft flat black rosette ø 58mm										

¹incl. knob

			
1			
Part No.	360544	Ref. No.	A040897
description	timer M11 with bell 1-pole operation time 15min impulse mechanical 1NO at 250V 16A permanent position no shaft ø 6mm shaft 6x4.6mm shaft L 15mm mounting distance 24mm mounting thread M3 connection male faston 6.3mm		
For models:	A151300, A151600		

			
1			
Part No.	350182	Ref. No.	OAT93623 A0AT93623
description	timer M11 with bell 1-pole operation time 15min impulse mechanical 1NO at 250V 16A permanent position no shaft ø 6x4.6mm shaft 6x4.6mm shaft L 15mm mounting distance 28mm		
For models:	A151300, A1515001, A151600		

			
1			
Part No.	360476	Ref. No.	01207908 A040897 (old version)
description	timer M11 with bell 2-pole operation time 15min 2NO at 250V 16A shaft ø 6mm shaft L 15mm connection male faston 6.3mm		

											
1											
Part No.	360510 ¹	Ref. No.	A040895								
description	timer M11 with bell 2-pole operation time 15min 2NO at 250V 16A shaft ø 6mm shaft L 15mm connection male faston 6.3mm with knob										
spare parts for	360510										
		<table border="1"> <tr> <td>Part No.</td> <td>112624</td> <td>Ref. No.</td> <td>A040898</td> </tr> </table>	Part No.	112624	Ref. No.	A040898	<table border="1"> <tr> <td>Part No.</td> <td>112624</td> <td>Ref. No.</td> <td>A040898</td> </tr> </table>	Part No.	112624	Ref. No.	A040898
Part No.	112624	Ref. No.	A040898								
Part No.	112624	Ref. No.	A040898								
	knob time 15min t.max.°C ø 41mm shaft ø 6mm shaft flat black rosette ø 58mm										
		<table border="1"> <tr> <td>Part No.</td> <td>360476</td> <td>Ref. No.</td> <td>01207908 A040897 (old version)</td> </tr> </table>	Part No.	360476	Ref. No.	01207908 A040897 (old version)	<table border="1"> <tr> <td>Part No.</td> <td>360476</td> <td>Ref. No.</td> <td>01207908 A040897 (old version)</td> </tr> </table>	Part No.	360476	Ref. No.	01207908 A040897 (old version)
Part No.	360476	Ref. No.	01207908 A040897 (old version)								
Part No.	360476	Ref. No.	01207908 A040897 (old version)								
	timer M11 with bell 2-pole operation time 15min 2NO at 250V 16A shaft ø 6mm shaft L 15mm connection male faston 6.3mm										

¹incl. knob



contactors

GENERAL ELECTRIC (AEG)

power contactors



1

Part No.	380244	Ref. No.	040100023
description	power contactor resistive load 25A 230VAC (AC3/400V) 9A/4kW main contacts 3NO auxiliary contacts 1NO connection screw connection type AEG LS4K 10A type GE CL00A 310		



1

Part No.	380264	Ref. No.	017594
description	power contactor resistive load 45A 230VAC (AC3/400V) 25A/11kW main contacts 3NO auxiliary contacts connection screw connection type AEG LS11K 00A type GE CL25A 300		

SIEMENS

power contactors



1

Part No.	380389	Ref. No.	0229037
description	power contactor resistive load 22A 230VAC (AC3/400V) 9A/4kW main contacts 3NO auxiliary contacts 1NO connection screw connection type 3RT10-16-1AP01		



1

Part No.	380957	Ref. No.	0927051
description	power contactor resistive load 22A 24VAC (AC3/400V) 12A/5.5kW main contacts 3NO auxiliary contacts 1NO connection screw connection type 3RT10-17-1AB01 50/60Hz		

miscellaneous

power contactors



1

Part No.	380915	Ref. No.	010578021
description	power contactor 230V resistive load 32A main contacts 3NO auxiliary contacts 1NO connection screw type CJX2-1810 SHAPU		
For models:	105780		

relays

power relays

with bracket mounting



1

Part No.	380312	Ref. No.	0229023 0229024
description	power relays FINDER 230VAC 10A 3CO connection male faston 4.8mm bracket mounting dimensions 52x32.2x36.5mm manuf. no. 60.63.8.230.0000		

1

Part No.	380139	Ref. No.	0926021
description	power relays FINDER 230VAC 16A 2CO connection F6.3 bracket mounting dimensions 68x38.2x35.8mm manuf. no. 62.82.8.230.0000		



1

Part No.	380403	Ref. No.	0229036
description	power relays FINDER 230VAC 16A 3CO connection F6.3 bracket mounting manuf. no. 62.83.8.230.0500		



1

Part No.	380185	Ref. No.	020473
description	power relays Italiana Relè 230VAC 30A 1NO connection F6.3 bracket mounting dimensions 36.5x32.2x51.8mm manuf. no. A10-230AC-FA		

magnetrons



1

Part No.	403173	Ref. No.	0610181C08
description	Magnetron type 2M248J(JT)		

probes

producer-specific probes

probes



1

Part No.	379887	Ref. No.	0SON006
description	temperature probe Pt100 cable high temperatur film probe -50 up to +200°C cable -50 up to +200°C connection 2-wire thread M10x1.5 probe ø5x42mm cable length 1.9m		

core probes



1

Part No.	379886	Ref. No.	0SON000
description	core temperature probe Pt100 cable PTFE probe -40 up to +250°C cable -40 up to +250°C connection 2-wire probe ø4x100mm thread M10x1.5 cable length 3m handle ø 15mm handle length 90mm		

electronics

PCBs



1

Part No.	402961	Ref. No.	01059331M
description	control PCB for induction device GIC2030 L 242mm W 69mm with digital display buttons 6		

1

Part No.		Ref. No.	01059353M
description	control PCB for induction device GIC2035 L 257mm W 75mm edition until 06/2010 buttons 6		

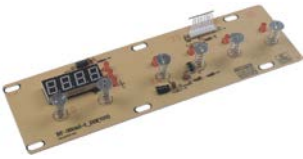

1

Part No.	402962	Ref. No.	01059353M2
description	control PCB induction device GIC2035 L 257mm W 75mm edition since 06/2010 buttons 6		



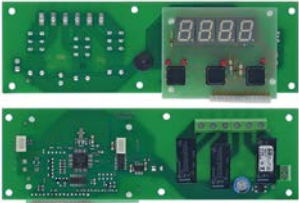



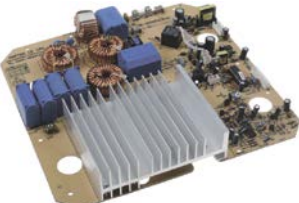

1 			
Part No.	400736	Ref. No.	06010083
description	control PCB salamander grill SH50SR		

1 			
Part No.	402960	Ref. No.	01059332M
description	main PCB for induction device GIC2030 L 237mm W 231mm		

1			
Part No.		Ref. No.	010583510M
description	main PCB for induction device GIC2035 L 236mm W 230mm until 06/2010		

1 			
Part No.	402959	Ref. No.	010583510M2
description	main PCB induction device GIC2035 L 236mm W 230mm since 06/2010		

1 			
Part No.	402045	Ref. No.	SA3600
description	PCB hand blenders FM3 with potentiometer 230V		

1 				
Part No.	400899	Ref. No.	0215018	
description	power PCB dishwasher LP10/20/30 without EPROM			
accessories for	400899			
	Part No.	400761	Ref. No.	—
plug connector 5-pole				
	Part No.	400900	Ref. No.	—
EPROM CODE 225029-3				
	Part No.	401558	Ref. No.	—
EPROM CODE 81000-1				
	Part No.	403241	Ref. No.	—
EPROM type U61E for dishwasher CODE 81001-3				
	Part No.	550048	Ref. No.	—
female bullet				

keypads

front foils

1 			
Part No.	400689	Ref. No.	A016769
description	keypad foil		





1 			
Part No.	403791	Ref. No.	02012427 02016790
description	keypad foil for salamander grill model suitable for BARTSCHER ømm for mounting pos. suitable for for model L 547mm W 67mm		



solenoid valves

solenoid valves (water)









TP			
			
1			
Part No.	370111	Ref. No.	0927001
description	solenoid valve double straight 24VAC inlet 3/4" outlet 11.5mm DN10 TP		
spare parts for	370111		
	Part No.	371035	Ref. No. —
	solenoid coil 24VAC		
accessories for	370111		
	Part No.	371220	Ref. No. —
	reducer TP flow rate 3l/min red tolerance ±15%		
	Part No.	371221	Ref. No. —
	reducer TP flow rate 5.5l/min yellow tolerance ±15%		
	Part No.	371222	Ref. No. —
	reducer TP flow rate 6l/min grey tolerance ±15%		
	Part No.	371223	Ref. No. —
	reducer TP flow rate 10l/min white tolerance ±15%		
	Part No.	371224	Ref. No. —
	reducer TP flow rate 12l/min bronze tolerance ±15%		
	Part No.	371225	Ref. No. —
	reducer TP flow rate 16l/min light brown tolerance ±15%		
	Part No.	371226	Ref. No. —
	reducer TP flow rate 20l/min red tolerance ±15%		
	Part No.	371230	Ref. No. —
	reducer TP flow rate 0.25l/min red tolerance ±25%		
	Part No.	371231	Ref. No. —
	reducer TP flow rate 0.35l/min violet tolerance ±25%		
	Part No.	371232	Ref. No. —
	reducer TP flow rate 0.5l/min orange tolerance ±25%		
	Part No.	371233	Ref. No. —
	reducer TP flow rate 0.8l/min white tolerance ±25%		
	Part No.	371234	Ref. No. —
	reducer TP flow rate 1l/min light blue tolerance ±25%		
	Part No.	371235	Ref. No. —
	reducer TP flow rate 1.2l/min brown tolerance ±25%		

accessories for 370111			
	Part No.	371236	Ref. No. —
	reducer TP flow rate 1.5l/min light brown tolerance ±25%		
	Part No.	371237	Ref. No. —
	reducer TP flow rate 2.5l/min yellow tolerance ±25%		
	Part No.	371238	Ref. No. —
	reducer TP flow rate 3.4l/min dark green tolerance ±25%		
	Part No.	371239	Ref. No. —
	reducer TP flow rate 5l/min black tolerance ±25%		
	Part No.	371240	Ref. No. —
	reducer TP flow rate 8l/min blue tolerance ±20%		

TP			
			
1			
Part No.	370017	Ref. No.	0240011
description	solenoid valve single straight 230VAC inlet 3/4" outlet 11.5mm DN10 TP p max 10bar		
spare parts for	370017		
	Part No.	371013	Ref. No. —
	solenoid coil TP 230VAC 50/60Hz		
accessories for	370017		
	Part No.	371220	Ref. No. —
	reducer TP flow rate 3l/min red tolerance ±15%		
	Part No.	371221	Ref. No. —
	reducer TP flow rate 5.5l/min yellow tolerance ±15%		
	Part No.	371222	Ref. No. —
	reducer TP flow rate 6l/min grey tolerance ±15%		
	Part No.	371223	Ref. No. —
	reducer TP flow rate 10l/min white tolerance ±15%		
	Part No.	371224	Ref. No. —
	reducer TP flow rate 12l/min bronze tolerance ±15%		
	Part No.	371225	Ref. No. —
	reducer TP flow rate 16l/min light brown tolerance ±15%		
	Part No.	371226	Ref. No. —
	reducer TP flow rate 20l/min red tolerance ±15%		
	Part No.	371230	Ref. No. —
	reducer TP flow rate 0.25l/min red tolerance ±25%		
	Part No.	371231	Ref. No. —
	reducer TP flow rate 0.35l/min violet tolerance ±25%		

Table continues overleaf



accessories for		370017	
	Part No.	371232	Ref. No. —
reducer TP flow rate 0.5l/min orange tolerance ±25%			
	Part No.	371233	Ref. No. —
reducer TP flow rate 0.8l/min white tolerance ±25%			
	Part No.	371234	Ref. No. —
reducer TP flow rate 1l/min light blue tolerance ±25%			
	Part No.	371235	Ref. No. —
reducer TP flow rate 1.2l/min brown tolerance ±25%			
	Part No.	371236	Ref. No. —
reducer TP flow rate 1.5l/min light brown tolerance ±25%			
	Part No.	371237	Ref. No. —
reducer TP flow rate 2.5l/min yellow tolerance ±25%			
	Part No.	371238	Ref. No. —
reducer TP flow rate 3.4l/min dark green tolerance ±25%			
	Part No.	371239	Ref. No. —
reducer TP flow rate 5l/min black tolerance ±25%			
	Part No.	371240	Ref. No. —
reducer TP flow rate 8l/min blue tolerance ±20%			

solenoid valves with reducers



1

Part No.	370628	Ref. No.	017696
description	solenoid valve double straight 230VAC inlet 3/4" input 16l/min DN10 TP plastic outlet 11.5mm		

various



1

Part No.	370589	Ref. No.	A0YXD4A39
description	solenoid valve single straight inlet 3/4" ET outlet 11.5mm male faston 6.3mm		
For models:	105780, A120788		

pressure switches

for warewashing

ø 58mm with male faston 6.3mm

with connection horizontal



1

Part No.	541002	Ref. No.	0224002
description	pressure control pressure range 110/60mbar connection 6mm ø 58mm pressure connection horizontal warewashing pressure connection ø 6mm		



1

Part No.	541105	Ref. No.	0926049
description	pressure control pressure range 180/70mbar connection 6mm ø 58mm pressure connection horizontal warewashing		



1

Part No.	541013	Ref. No.	0929039
description	pressure control pressure range 55/25mbar connection 6mm ø 58mm pressure connection horizontal warewashing		



1

Part No.	541003	Ref. No.	011515 011595 0224003
description	pressure control pressure range 55/35mbar connection 6mm ø 58mm pressure connection horizontal warewashing pressure connection ø 6mm		



compressors

ACC/ZEL

R600A

LBP monophase

Lower evaporation temperature below -20°C



1

Part No.	605150	Ref. No.	038281
description	compressor coolant R600a type HVM10AA 220-240V 50Hz LBP 8.7kg 1/6HP cylinder capacity 10cm³ RSIR H 180mmWWWWWWWWW		

fans

axial fans

import



1

Part No.	601743	Ref. No.	01058355
description	axial fan L 80mm W 80mm H 25mm 18VDC 1.8W connection coded plug cable length 300mm		

refrigeration fans

cooling motors (complete)

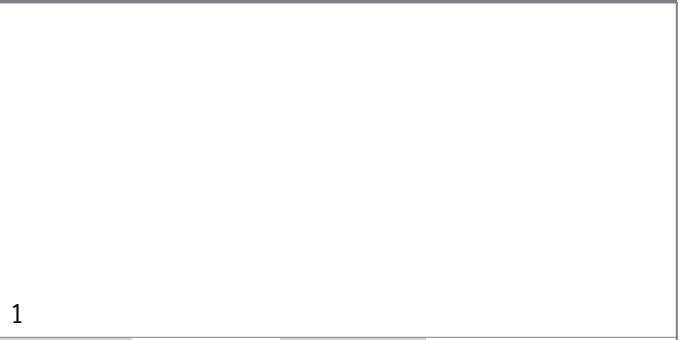

1

Part No.		Ref. No.	030609
description	fan 230V 10W		

cold air circulating fans (other)



1

Part No.	602132	Ref. No.	038169
description	fan motor 220-240V 50Hz IN 22W / OUT 5W shaft ø 4mm shaft L 20/48mm L 65mm W 66mm H 73mm fan wheel ø 150mm Qty 1 pcs		
For models:	700158G-McDonalds		

cross flow fans

COPREL

with standard coil



1

Part No.	601453	Ref. No.	030008386
description	cross flow fan TFR 180 roller ø 60mm roller length 180mm laminated core thickness 16mm motor position right 230V/50-60Hz 17W universal bearing silicone connection male faston 6.3mm airflow 100m³/h -30 up to +100°C 230V 50Hz		

accessories for	601453			
	Part No.	415114	Ref. No.	—
	heater battery mounting distance 185mm W 40mm H 35mm 2000W 230V temperature restriction 105°C heating circuits 2 connection cable length 150mm L 192mm for cross flow fan			



hot air motors



1

Part No.	601993	Ref. No.	OMOT001
description	fan motor 230V 1 phase 50Hz 0.18/0.12kW 2800rpm speeds 1 L1 85mm L2 65mm L3 23mm D1 ø 8mm D2 ø 6mm M5x0.8 0.8A suitable capacitor 5µF/450V		
accessories for	601993		
	Part No.	365017	Ref. No. —
	operating capacitor capacity 5µF 450V tolerance 5% 50/60Hz ambient temperature max. -25 to +85°C ø 28mm L 54mm M8 plastic connection male faston 6.3mm 16.10.08 protection		



1

Part No.	601690	Ref. No.	010578043
description	fan motor 230V 50Hz 0.09kW 2450rpm L1 80mm L2 20mm L3 35mm L4 20mm D1 ø 12mm D2 ø 8x6mm M5		
For models:	105780		



1

Part No.	601688	Ref. No.	010578050
description	fan wheel D1 ø 200mm H1 43mm blades 39 D2 ø 8x6mm D3 ø 8mm H2 29mm		
For models:	105780		

hot air fans

miscellaneous



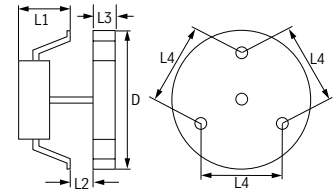

1

Part No.	601124	Ref. No.	009G623
description	hot air fan 220-240V 30W L1 60mm L2 12mm L3 25mm L4 84mm fan wheel ø 150mm IMS type VRB150H2028		



1

Part No.	601054	Ref. No.	023117700
description	hot air fan 220-240V 32W 50/60Hz L1 60mm L2 10mm L3 25mm L4 87mm fan wheel ø 150mm FIME type C20X0E01/46		
spare parts for	601054		
	Part No.	601441	Ref. No. —
	fan wheel ø 150mm W 25mm shaft intake ø 6x5mm stainless steel blades 7		
accessories for	601054		
	Part No.	550879	Ref. No. —
	insulation ø 130mm thickness 3mm hole ø 20mm for hot air fan		

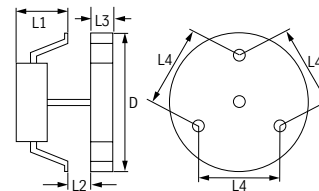

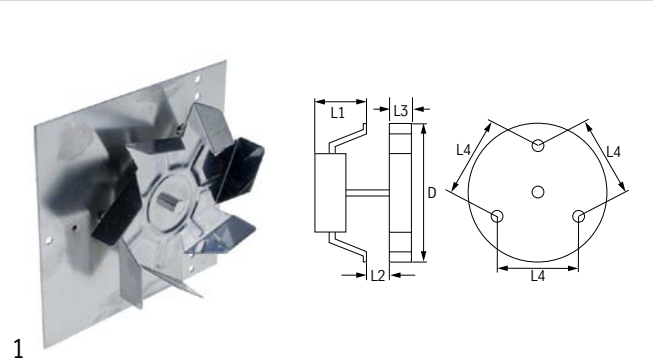

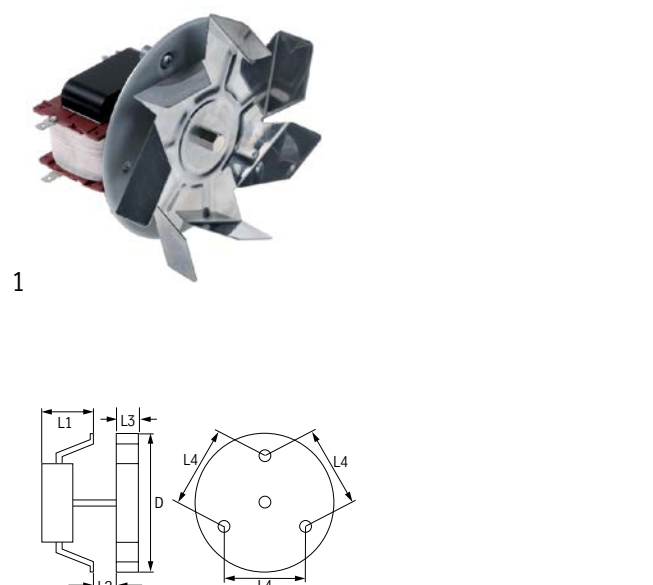

1

Part No.	601548	Ref. No.	A0000103006
description	hot air fan 220-240V 40W 50/60Hz L1 65mm L2 11mm L3 25mm L4 87mm fan wheel ø 150mm FIME type C25R8023CLH		
accessories for	601548		
	Part No.	601441	Ref. No. —
	fan wheel ø 150mm W 25mm shaft intake ø 6x5mm stainless steel blades 7		



1

Part No.	601125	Ref. No.	0A036410
description	hot air fan 220-240V 45W 50/60Hz L1 70mm L2 11mm L3 25mm L4 87mm fan wheel ø 150mm FIME type C30R0479CLF		
For models:	A120788		
accessories for	601125		
	Part No.	550879	Ref. No. —
	insulation ø 130mm thickness 3mm hole ø 20mm for hot air fan		

motors

gear motors

for conveyor toaster



1

Part No.	602131	Ref. No.	A01002057 QXYH6030M23G
description	gear motor W 230V voltage AC 50Hz 1 phaserpm shaft ø 7mm L 92mm W 60mm H 96mm		

for ice-cube maker

for paddles



1

Part No.	501535	Ref. No.	010402530
description	gear motor type 50KTYZ 6W 220-240V 50/60Hz 33/40rpm shaft ø 7mm		









pumps

wash and rinse pumps

LGB



1

Part No.	500156	Ref. No.	0130109
description	pump inlet \varnothing 50mm outlet \varnothing 50mm type ZF400SX 230V 50Hz 1 phase 0.6kW 0.8HP L 210mm rotation direction right capacitor 16 μ F LGB		
spare parts for	500156		
	Part No.	509020	Ref. No. —
	impeller \varnothing 104mm H 25mm M8L		
	Part No.	510703	Ref. No. —
	mechanical shaft seal for shaft \varnothing 13mm slide ring H 13mm height counter ring 5.5mm ED \varnothing 26mm		
	Part No.	521548	Ref. No. —
	pump cover LGB inlet \varnothing 50mm outlet \varnothing 50mm		
	Part No.	521734	Ref. No. —
	pump cover bottom part		
	Part No.	523509	Ref. No. —
	deep-groove ball bearing type 6201-2RS shaft \varnothing 12mm ED \varnothing 32mm W 10mm with sealing discs deep-groove ball bearing DIN 625-1		
	Part No.	532623	Ref. No. —
	O-ring EPDM thickness 2.62mm ID \varnothing 120.32mm Qty 1 pcs		
accessories for	500156		
	Part No.	365021	Ref. No. 0206004
	operating capacitor capacity 16 μ F 425V tolerance 5% 50/60Hz ambient temperature max. -25 to +85°C \varnothing 35mm L 73mm single M8 plastic connection male faston 6.3mm 416.10.99 protection		

OLYMPIA

pumps



1

Part No.	500003	Ref. No.	020727
description	pump inlet \varnothing 45mm outlet \varnothing 32mm type T30 230V 50Hz 1 phase 0.29kW 0.39HP L 190mm rotation direction right capacitor 8 μ F OLYMPIA		
spare parts for	500003		
	Part No.	365013	Ref. No. —
	operating capacitor capacity 8 μ F 400V tolerance 5%Hz ambient temperature max. -25 to +85°C \varnothing 31.5mm L 55mm M8 plastic connection male faston 6.3mm protection		
	Part No.	510512	Ref. No. 023317
	pump cover OLYMPIA inlet \varnothing 45mm outlet \varnothing 31mm outlet 2 \varnothing 24 turn direction right \varnothing 130mm ID \varnothing 124mm inner height 20mm		
	Part No.	510554	Ref. No. —
	O-ring EPDM thickness 2mm ID \varnothing 120mm Qty 1 pcs		
	Part No.	510615	Ref. No. 012263
	impeller \varnothing 90mm H 22mm rotation direction right thread M10L blades 4		
	Part No.	510693	Ref. No. 0141002 021188
	mechanical shaft seal for shaft \varnothing 12mm slide ring ext. \varnothing 24mm slide ring H 15.5mm slide ring int. \varnothing 11mm counter ring mounting \varnothing 24mm height counter ring 8mm counter ring int. \varnothing 13.5mm		



1

Part No.	500525	Ref. No.	0150914
description	pump inlet ø 50mm outlet ø 30mm type T7 230V 50Hz 1 phase 0.52kW 0.71HP L 230mm rotation direction right capacitor 12.5µF OLYMPIA		
spare parts for	500525		
	Part No.	365014	Ref. No. —
	operating capacitor capacity 12.5µF 450V tolerance 5%Hz ambient temperature max. -25 to +85°C ø 35mm L 70mm M8 plastic connection male faston 6.3mm 45S.C3DS.12.5 protection		
	Part No.	510554	Ref. No. —
	O-ring EPDM thickness 2mm ID ø 120mm Qty 1 pcs		
	Part No.	510693	Ref. No. 0141002 021188
	mechanical shaft seal for shaft ø 12mm slide ring ext. ø 24mm slide ring H 15.5mm slide ring int. ø 11mm counter ring mounting ø 24mm height counter ring 8mm counter ring int. ø 13.5mm		
	Part No.	517368	Ref. No. —
	impellor ø 102mm H 21mm rotation direction right thread M10L suitable for Dühr blades 8		
	Part No.	521556	Ref. No. —
	pump cover OLYMPIA inlet ø 50mm outlet ø 30mm outlet 2 ø 30 auxiliary pressure connection 10mm supporting pressure open turn direction right ø 130mm ID ø 124mm inner height 20mm		

drain pumps

ASKOLL



1

Part No.	500214	Ref. No.	0130105 0130146
description	drain pump inlet ø 30mm outlet ø 22mm 230/240V 30W 50Hz ASKOLL type R113		

condensators & interference suppression filters

operating capacitors

plastic

	1		
Part No.	365021	Ref. No.	0206004
description	operating capacitor capacity 16µF 425V tolerance 5% 50/60Hz ambient temperature max. -25 to +85°C ø 35mm L 73mm single M8 plastic connection male faston 6.3mm 416.10.99 protection		

	1		
Part No.	365019	Ref. No.	0206005
description	operating capacitor capacity 20µF 400V tolerance 5% 50/60Hz ambient temperature max. -25 to +85°C ø 39.5mm L 70mm M8 plastic connection male faston 6.3mm 16.10.25. protection		

	1		
Part No.	365028	Ref. No.	010578025
description	operating capacitor capacity 3µF 450V tolerance 5% 50/60Hz ambient temperature max. -25 to +85°C ø 35.5mm L 75mm M8 plastic connection male faston 6.3mm protection		
For models:	105780		

filters

interference suppression filters

	1		
Part No.	365044	Ref. No.	0926144
description	interference suppression filter type FC701Y2F 250V 50-60Hz conductor 2 with E connection cable 200mm L 42mm ø 23mm Hmm Wmm plastic Qty 1 pcs		



fuses

fine fuses

			
1			
Part No.	358533	Ref. No.	01143561
description	fine fuse size ø5x20mm 6.3A fast-acting rated 250V Qty 10 pcs		

electric accessories

terminals

terminal blocks

			
1			
Part No.	693220	Ref. No.	030008125
description	lustre terminal 12-pole cross section 4mm² max. 32A max 750V temp.-resist. 150°C		

connection terminals with screw/faston connections

			
1			
Part No.	550411	Ref. No.	0220011
description	power terminal block 6-pole max. 40A max 450V connection ø6mm² / F6.3 temp.-resist. 150°C cross section 6mm²		

connection terminals with screw connection

			
1			
Part No.	551109	Ref. No.	A01506752
description	connecting cable 4-pole max. 15A max 500V connection screw temp.-resist. 150°C		
For models:	A150671, A150674		

			
1			
Part No.	551021	Ref. No.	OAT93621 A0AT93621
description	porcelain terminal block 3-pole max. 15A max 500V connection screw temp.-resist. 150°C with fastening angle t.max. 150°C Qty 1 pcs		
For models:	151510, A151300, A1515001, A151600		

gas taps

PEL

22S/O series











			
1			
Part No.	101086	Ref. No.	010909
description	gas tap PEL type 22S/O gas inlet M20x1.5 (tube ø 12mm) bypass nozzle ø 0.35mm gas outlet M20x1.5 (tube ø 12/10mm) thermocouple connection M9x1 pilot connection M10x1 shaft ø 10x8mm shaft L 25/17mm shaft flat lower		
spare parts for	101086		
	Part No.	100259	Ref. No. —
	bypass nozzle type PEL22 bore ø 0.35mm thread M6x0.5		
	Part No.	101058	Ref. No. —
	magnet unit L 39mm D1 ø 15.4mm D2 ø 13.5mm suitable for PEL22/EGA24197 standard		
	Part No.	101201	Ref. No. —
	gas tap front part shaft ø 10x8mm shaft L 25/17mm shaft flat upper/lower suitable for PEL22		
	Part No.	101231	Ref. No. —
	thermocouple nut T1: M9x1 T2: M18x1		
	Part No.	101240	Ref. No. —
	gas connection thread M20x1.5 tube ø 12/10mm for PEL gas taps with gasket and screws horizontal		
	Part No.	101460	Ref. No. —
	O-ring ø 12.37mm D1 ø 2.62mm suitable for PEL22		
	Part No.	101461	Ref. No. —
	screw kit suitable for PEL22 Qty 4 pcs		
accessories for	101086		
	Part No.	100908	Ref. No. —
	union screw thread M10x1 for pipe ø 4mm Qty 1 pcs		
	Part No.	100909	Ref. No. —
	union screw thread M10x1 for pipe ø 6mm Qty 1 pcs		
	Part No.	101241	Ref. No. —
	gas connection thread M20x1.5 tube ø 12/10mm for PEL gas taps vertical		

Table continues overleaf



accessories for		101086		
Part No.		101246	Ref. No.	—
	olive for pipe ø 4mm Qty 1 pcs			
Part No.		101248	Ref. No.	—
	olive for pipe ø 12mm Qty 1 pcs suitable for PEL			
Part No.		101249	Ref. No.	—
	olive for pipe ø 10mm Qty 1 pcs			
Part No.		101250	Ref. No.	—
	union nut thread M20x1.5 for pipe ø 10mm			
Part No.		101251	Ref. No.	—
	union nut thread M20x1.5 for pipe ø 12mm			
Part No.		101286	Ref. No.	—
	olive ID ø 6mm Qty 1 pcs			
Part No.		110080	Ref. No.	—
	knob ø 70mm shaft ø 10x8mm shaft flat universal			
Part No.		112206	Ref. No.	—
	knob dial plate silver gas tap PEL21/22/23 t.max.°C ED ø 63mm ID ø 45.5mm			

COPRECI

CAL-5200



1

Part No.	106036	Ref. No.	010038
description	gas tap COPRECI type CAL-5200 gas inlet pipe flange ø21mm bypass nozzle ø 0.35mm gas outlet M14x1.5 (tube ø 6mm) thermocouple connection M8x1 pilot connection shaft ø 6x4.6mm shaft L 25/16mm shaft flat lower with pipe outlet		
spare parts for	106036		
	Part No.	101060	Ref. No. —

SABAF



1

Part No.	106062	Ref. No.	001G463
description	gas tap SABAF type 10 gas inlet pipe flange ø16mm bypass nozzle ø 0.25mm gas outlet M13x1 IT (tube ø 8mm) front fixing thermocouple connection plug-in connection shaft ø 8x6.5mm shaft L 45/12mm shaft flat lower		
spare parts for	106062		
	Part No.	106723	Ref. No. —
accessories for	106062		
	Part No.	101277	Ref. No. —
	Part No.	101376	Ref. No. —
	Part No.	101477	Ref. No. —
	Part No.	101751	Ref. No. —
	Part No.	560082	Ref. No. —

gas thermostats

SIT

630 Eurosit series







1

Part No.	101992	Ref. No.	035271800
description	gas thermostat type 630 Eurosit series t.max. 190°C 110-190°C gas inlet 3/8" gas outlet 3/8" thermocouple connection M9x1 pilot connection M10x1 probe ø 4mm probe L 202mm capillary pipe 1050mm SIT		
accessories for	101992		
	Part No.	100904	Ref. No. —
	Part No.	100905	Ref. No. —

Table continues overleaf



accessories for	101992			
	Part No.	101273	Ref. No.	—
	olive for pipe ø 12mm L 9.5mm brass Qty 1 pcs suitable for universal			
	Part No.	101276	Ref. No.	—
	union screw thread 3/8" tube ø 12mm Qty 1 pcs			
	Part No.	101333	Ref. No.	—
	plug thread 3/8" with O-ring			
	Part No.	510655	Ref. No.	—
	gasket silicone ø 7.8mm L 5mm blue Shore 55° Qty 10 pcs			

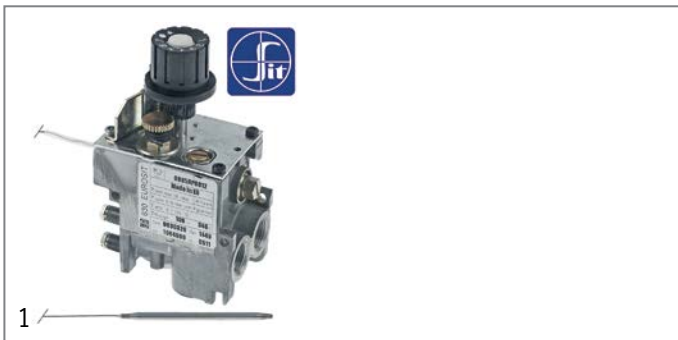

Part No.	101125	Ref. No.	023035	
description	gas thermostat type 630 Eurosit series t.max. 340°C 100-340°C gas inlet 3/8" gas outlet 3/8" thermocouple connection M9x1 pilot connection M10x1 probe ø 4mm probe L 72mm capillary pipe 1050mm SIT			
accessories for	101125			
	Part No.	100825	Ref. No.	—
	gas tap spindle shaft ø 8x6.5mm shaft L 22/14mm suitable for EUROSIT			
	Part No.	100904	Ref. No.	—
	locking screw M10x1 for pipe ø 4mm Qty 1 pcs			
	Part No.	100905	Ref. No.	—
	locking screw M10x1 for pipe ø 6mm Qty 1 pcs			
	Part No.	100949	Ref. No.	—
	gasket suitable for 630 Eurosit series			
	Part No.	101273	Ref. No.	—
	olive for pipe ø 12mm L 9.5mm brass Qty 1 pcs suitable for universal			
	Part No.	101276	Ref. No.	—
	union screw thread 3/8" tube ø 12mm Qty 1 pcs			
	Part No.	101333	Ref. No.	—
	plug thread 3/8" with O-ring			
	Part No.	101390	Ref. No.	—
	gas tap spindle shaft ø 6x4.6mm shaft L 32/15mm gas tap with ignition flame suitable for ZANUSSI, MARENO for gas thermostat EUROSIT			
	Part No.	101392	Ref. No.	—
	adapter suitable for 630 Eurosit series			
	Part No.	110357	Ref. No.	—
	gas tap spindle shaft ø 8x6.5mm shaft L 36/12mm suitable for 630 Eurosit series			
	Part No.	110358	Ref. No.	—
	adapter shaft ø 10x8mm shaft L 29/18mm suitable for 630 Eurosit series			

710 Minisit series

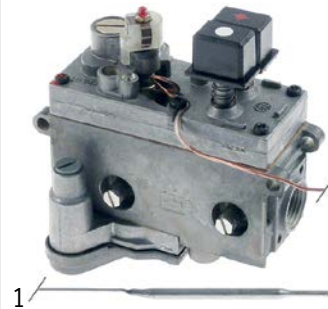

Part No.	101437	Ref. No.	010425	
description	gas thermostat SIT type MINISIT 710 t.max. 190°C 110-190°C gas inlet 1/2" gas outlet 3/8" thermocouple connection M9x1 pilot connection M10x1 probe ø 6mm probe L 102mm capillary pipe 1050mm probe type type A3 pressure controller yes pressure regulator 3-18mbar gland nut			
spare parts for	101437			
	Part No.	101053	Ref. No.	—
	magnet unit T1: M9x1 T2: M24x1 L 45mm ø 17mm suitable for Minisit			
	Part No.	102118	Ref. No.	—
	probe 110-190°C probe ø 6mm probe L 102mm capillary pipe 1050mm t.max. 190°C fryer probe type type A3 suitable for MINISIT 710			
accessories for	101437			
	Part No.	100809	Ref. No.	—
	O-ring EPDM thickness 2mm ID ø 21mm Qty 1 pcs			
	Part No.	100820	Ref. No.	—
	gland duct ET M14x1.5 IT M10x0.75 probe ø max. 6.5mm WS 22			
	Part No.	100904	Ref. No.	—
	locking screw M10x1 for pipe ø 4mm Qty 1 pcs			
	Part No.	100905	Ref. No.	—
	locking screw M10x1 for pipe ø 6mm Qty 1 pcs			
	Part No.	101054	Ref. No.	—
	magnet unit T1: M10x1 T2: M24x1 L 45mm ø 17mm suitable for Minisit			
	Part No.	101136	Ref. No.	—
	piezoelectric igniter suitable for Minisit with cover cap ømm connection F6.3x0.8			
	Part No.	101137	Ref. No.	—
	cover cap without piezoelectric igniter			
	Part No.	101267	Ref. No.	—
	reducer IT 3/8" ET 1/2" L 21mm			
	Part No.	101268	Ref. No.	—
	gas connection thread 3/8" angled with O-ring MINISIT 710			
	Part No.	101269	Ref. No.	—
	gas connection thread 1/2" angled with O-ring MINISIT 710			
	Part No.	101270	Ref. No.	—
	screw connection IT 3/8" ET 3/8" L 28mm			

Table continues overleaf



accessories for		101437		
Part No.	Ref. No.	Ref. No.	Ref. No.	—
	101272			
screw connection IT 1/2" ET 3/8" L 57mm				
	101273			
olive for pipe ø 12mm L 9.5mm brass Qty 1 pcs suitable for universal				
	101274			
olive for pipe ø 16mm Qty 1 pcs				
	101275			
union screw thread 1/2" for pipe ø 16mm Qty 1 pcs				
	101276			
union screw thread 3/8" tube ø 12mm Qty 1 pcs				
	110068			
knob suitable for Minisit ø 37mm				

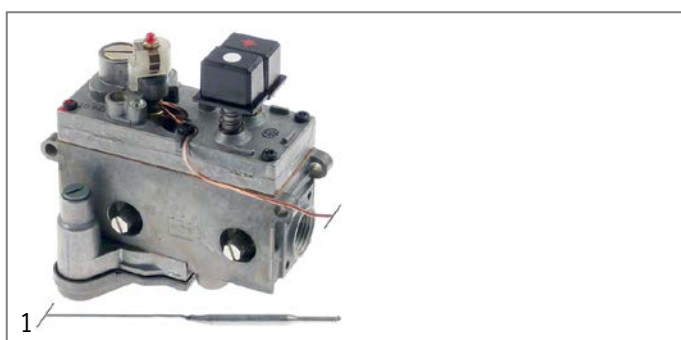

Part No.	101438	Ref. No.	010829
description	gas thermostat SIT type MINISIT 710 t.max. 340°C 100-340°C gas inlet 1/2" gas outlet 3/8" thermocouple connection M9x1 pilot connection M10x1 probe ø 5mm probe L 68mm capillary pipe 1050mm probe type type B1 pressure controller yes pressure regulator 3-18mbar gland nut		

spare parts for		101438		
Part No.	Ref. No.	Ref. No.	Ref. No.	—
	101053			
magnet unit T1: M9x1 T2: M24x1 L 45mm ø 17mm suitable for Minisit				
	102102			
probe 100-340°C probe ø 5mm probe L 68mm capillary pipe 1750mm t.max. 340°C oven/grill probe type type B1 suitable for MINISIT 710				

accessories for		101438		
Part No.	Ref. No.	Ref. No.	Ref. No.	—
	100809			
O-ring EPDM thickness 2mm ID ø 21mm Qty 1 pcs				
	100904			
locking screw M10x1 for pipe ø 4mm Qty 1 pcs				
	100905			
locking screw M10x1 for pipe ø 6mm Qty 1 pcs				
	101054			
magnet unit T1: M10x1 T2: M24x1 L 45mm ø 17mm suitable for Minisit				
	101136			
piezoelectric igniter suitable for Minisit with cover cap ø 6mm connection F6.3x0.8				
	101137			
cover cap without piezoelectric igniter				

accessories for		101438		
Part No.	Ref. No.	Ref. No.	Ref. No.	—
	101267			
reducer IT 3/8" ET 1/2" L 21mm				
	101268			
gas connection thread 3/8" angled with O-ring MINISIT 710				
	101269			
gas connection thread 1/2" angled with O-ring MINISIT 710				
	101270			
screw connection IT 3/8" ET 3/8" L 28mm				
	101272			
screw connection IT 1/2" ET 3/8" L 57mm				
	101273			
olive for pipe ø 12mm L 9.5mm brass Qty 1 pcs suitable for universal				
	101274			
olive for pipe ø 16mm Qty 1 pcs				
	101275			
union screw thread 1/2" for pipe ø 16mm Qty 1 pcs				
	101276			
union screw thread 3/8" tube ø 12mm Qty 1 pcs				
	110068			
knob suitable for Minisit ø 37mm				

PEL

24ST series



Part No.	101076	Ref. No.	016880
description	gas thermostat PEL type 24ST 120-320°C gas inlet M20x1.5 (tube ø 12mm) bypass nozzle ø 0.35mm gas outlet M20x1.5 (tube ø 12/10mm) thermocouple connection M9x1 pilot connection M10x1 capillary pipe 1200mm probe ø 6mm probe L 100mm shaft ø 10x8mm shaft L 27/17mm shaft flat upper		

spare parts for		101076		
Part No.	Ref. No.	Ref. No.	Ref. No.	—
	100455			
bypass nozzle type PEL23/24 bore ø 0.35mm thread M8x0.5				
	101058			
magnet unit L 39mm D1 ø 15.4mm D2 ø 13.5mm suitable for PEL22/ EGA24197 standard				
	106200			
nut thread M9x1 suitable for PEL 24/25S				

Table continues overleaf



accessories for		101076		
	Part No.	100908	Ref. No.	—
	union screw thread M10x1 for pipe ø 4mm Qty 1 pcs			
	Part No.	100909	Ref. No.	—
	union screw thread M10x1 for pipe ø 6mm Qty 1 pcs			
	Part No.	101246	Ref. No.	—
	olive for pipe ø 4mm Qty 1 pcs			
	Part No.	101248	Ref. No.	—
	olive for pipe ø 12mm Qty 1 pcs suitable for PEL			
	Part No.	101249	Ref. No.	—
	olive for pipe ø 10mm Qty 1 pcs			
	Part No.	101250	Ref. No.	—
	union nut thread M20x1.5 for pipe ø 10mm			
	Part No.	101251	Ref. No.	—
	union nut thread M20x1.5 for pipe ø 12mm			
	Part No.	101286	Ref. No.	—
	olive ID ø 6mm Qty 1 pcs			
	Part No.	110079	Ref. No.	—
	knob dial plate gas thermostat 1-8 silver			
	Part No.	110080	Ref. No.	—
	knob ø 70mm shaft ø 10x8mm shaft flat universal			

gas valves and ignition boxes



gas control valves



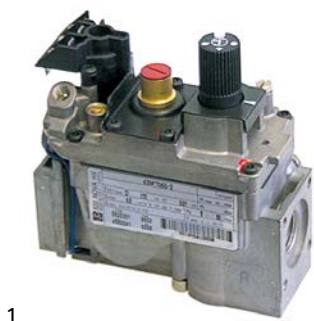

SIT

NOVASIT



1

Part No.	101187	Ref. No.	030100014	
description	gas valve SIT series Novasit 820 0.17VHz gas inlet 1/2" gas outlet 1/2" thermocouple connection M9x1 pilot connection M10x1 ignition pressurebar pressure range 5-50mbar pressure regulator connection blind equiv. no. 0.820.301 supply Operator millivolt			
spare parts for	101187			
	Part No.	101065	Ref. No.	—
	magnet unit with cable L 44mm D1 ø 30mm D2 ø 20mm suitable for NOVASIT			
accessories for	101187			
	Part No.	100110	Ref. No.	030100000
	pilot burner SIT type 190 series 3 flames nozzle ømm gas connectionmm			

accessories for		101187		
	Part No.	101305	Ref. No.	—
	gas connection straight 1/2" flange 45x45mm ELETROSIT/V4400/4600/4605 suitable for SIT/HONEYWELL hole distance 36x36mm			
	Part No.	101306	Ref. No.	—
	gas connection angled flange 45x45mm hole distance 36x36mm 1/2" ELETROSIT/V4400/4600/4605 screw with O-ring suitable for SIT/HONEYWELL			
	Part No.	101307	Ref. No.	—
	gas connection straight flange 45x45mm hole distance 36x36mm 3/4" ELETROSIT/V4400/4600/4605 screw with O-ring suitable for SIT/HONEYWELL			
	Part No.	101308	Ref. No.	—
	gas connection angled flange 45x45mm hole distance 36x36mm 3/4" ELETROSIT/V4400/4600/4605 screw with O-ring suitable for SIT/HONEYWELL			
	Part No.	102116	Ref. No.	040400130
	thermopile ROBERTSHAW L 900mm probe ø 9mm probe L 57mm 250-750mV screw connection 7/16"			

ignition boxes

HONEYWELL



1

Part No.	102367	Ref. No.	OCEN000	
description	ignition box HONEYWELL type S4565A 2092 1 electrodes 3 waiting times safety time 10s 220-240V 4VA 50/60Hz			

ignition parts

pilot burners

SIT

100 series

accessories

pilot burner bottom parts



1











Part No.	107701	Ref. No.	020484	
description	pilot burner bottom part SIT 100 series nozzle ø 0.2mm			
spare parts for	107701			
	Part No.	100245	Ref. No.	016106
	pilot burner nozzle LPG code 20 bore ø 0.2mm Qty 1 pcs thread M8x0.75			

Table continues overleaf







spare parts for		107701		
	Part No.	100916	Ref. No.	—
compression spring for pilot burner Qty 1 pcs				
	Part No.	100917	Ref. No.	—
gasket for pilot burner Qty 1 pcs aluminium				
	Part No.	100918	Ref. No.	—
screw for pilot burner				
accessories for		107701		
	Part No.	100246	Ref. No.	—
pilot burner nozzle natural gas bore ø 0.35mm Qty 1 pcs thread M8x0.75				
	Part No.	100904	Ref. No.	—
locking screw M10x1 for pipe ø 4mm Qty 1 pcs				
	Part No.	100905	Ref. No.	—
locking screw M10x1 for pipe ø 6mm Qty 1 pcs				
	Part No.	102110	Ref. No.	—
pilot tube copper pipe ø 4mm thickness 1mm L 3000mm				
	Part No.	102111	Ref. No.	—
pilot tube copper pipe ø 6mm thickness 1mm L 3000mm				
	Part No.	102742	Ref. No.	—
pilot burner nozzle LPG code 25 bore ø 0.25mm Qty 1 pcs				

pilot burner nozzles

	1			
Part No.	100245	Ref. No.	016106	
description	pilot burner nozzle LPG code 20 bore ø 0.2mm Qty 1 pcs thread M8x0.75			
For models:	105014			

190 series

	1			
Part No.	100110	Ref. No.	030100000	
description	pilot burner SIT type 190 series 3 flames nozzle ømm gas connectionmm			
accessories for		100110		
	Part No.	100202	Ref. No.	—
pilot burner nozzle natural gas code 41 Qty 1 pcs nozzle ø 0.41mm				
	Part No.	100203	Ref. No.	—
pilot burner nozzle LPG code 25 Qty 1 pcs nozzle ø 0.25mm				
	Part No.	100701	Ref. No.	—
ignition electrode connection M4 Qty 1 pcs				
	Part No.	100906	Ref. No.	—
screw connection thread M10x1 for ignition electrode brass Qty 1 pcs WS 10				

accessories for		100110		
	Part No.	100907	Ref. No.	—
screw connection thread M10x1 Qty 1 pcs type SEF 1 ømm for thermocouple				
	Part No.	100908	Ref. No.	—
union screw thread M10x1 for pipe ø 4mm Qty 1 pcs				
	Part No.	100909	Ref. No.	—
union screw thread M10x1 for pipe ø 6mm Qty 1 pcs				
	Part No.	101282	Ref. No.	—
olive for pipe ø 4mm L 7.4mm Qty 1 pcs				
	Part No.	101287	Ref. No.	—
olive for pipe ø 6mm Qty 1 pcs				
	Part No.	102110	Ref. No.	—
pilot tube copper pipe ø 4mm thickness 1mm L 3000mm				
	Part No.	102111	Ref. No.	—
pilot tube copper pipe ø 6mm thickness 1mm L 3000mm				
	Part No.	107650	Ref. No.	—
pilot burner nozzle SIT LPG code 30 Qty 1 pcs				





POLIDORO

pilot burners



	1			
Part No.	102295	Ref. No.	016081	
description	pilot burner POLIDORO 3 flames code gas connection 4mm			
spare parts for		102295		
	Part No.	100907	Ref. No.	—
screw connection thread M10x1 Qty 1 pcs type SEF 1 ømm for thermocouple				
accessories for		102295		
	Part No.	100208	Ref. No.	—
pilot burner nozzle POLIDORO LPG code 20 bore ø 0.2mm Qty 1 pcs				
	Part No.	100209	Ref. No.	—
pilot burner nozzle POLIDORO natural gas code 40 bore ø 0.4mm Qty 1 pcs				
	Part No.	100701	Ref. No.	—
ignition electrode connection M4 Qty 1 pcs				
	Part No.	100906	Ref. No.	—
screw connection thread M10x1 for ignition electrode brass Qty 1 pcs WS 10				
	Part No.	100908	Ref. No.	—
union screw thread M10x1 for pipe ø 4mm Qty 1 pcs				
	Part No.	100909	Ref. No.	—
union screw thread M10x1 for pipe ø 6mm Qty 1 pcs				

Table continues overleaf



accessories for	102295		
	Part No.	101280	Ref. No. —
	olive for pipe ø 4mm Qty 1 pcs		
	Part No.	101287	Ref. No. —
	olive for pipe ø 6mm Qty 1 pcs		
	Part No.	102110	Ref. No. —
	pilot tube copper pipe ø 4mm thickness 1mm L 3000mm		
	Part No.	102111	Ref. No. —
	pilot tube copper pipe ø 6mm thickness 1mm L 3000mm		

electrodes

			
Part No.	100724	Ref. No.	010288
description	ignition electrode D1 ø 8mm BL1 13mm BL2 28mm BL3 8mm connection F 2.8x0.8mm M10x0.75		
accessories for	100724		
	Part No.	519546	Ref. No. —
	nut thread M10x0.75 H 3.45mm WS 14 brass Qty 1 pcs		



thermocouples

threaded thermocouples



threaded thermocouples standard

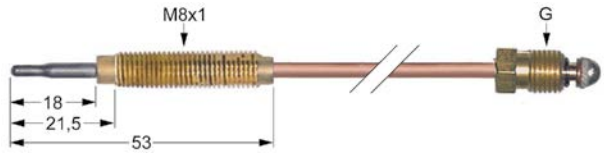

with socket with thread M8x1

type Junkers with aluminised tip

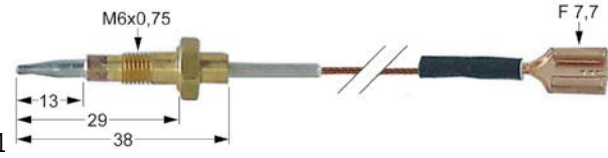
			
Part No.	102233	Ref. No.	016991 019991
description	thermocouple M8x1 L 750mm M8x1		
accessories for	102233		
	Part No.	102067	Ref. No. —
	nut thread M8x1 H 3mm brass Qty 1 pcs type SEF 1		

threaded thermocouples with cable link

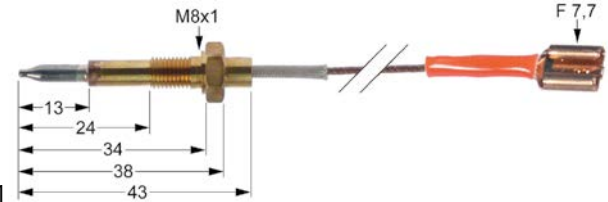
			
Part No.	102274	Ref. No.	001Q855
description	thermocouple with 1 conductor L 450mm connection F 7.7mm M6x0.75		
accessories for	102274		
	Part No.	102680	Ref. No. —
	nut thread M6x0.75 H 2.6mm WS 8 brass Qty 1 pcs type SEF 2		

			
Part No.	102275	Ref. No.	001Q876
description	thermocouple with 1 conductor L 450mm connection F 7.7mm M6x0.75		
accessories for	102275		
	Part No.	102680	Ref. No. —
	nut thread M6x0.75 H 2.6mm WS 8 brass Qty 1 pcs type SEF 2		

thermopiles

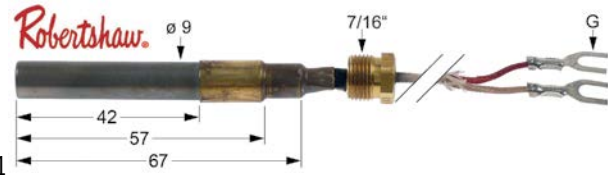
			
Part No.	102116	Ref. No.	040400130
description	thermopile ROBERTSHAW L 900mm probe ø 9mm probe L 57mm 250-750mV screw connection 7/16"		

gas burners





hob burners





universal hob burners

GEV





			
Part No.	106379	Ref. No.	N/A
description	air mixing tube for burner cap ø 80mm L 23mm D1 ø 20mm D2 ø 15.6mm D3 ø 14mm		











 <p>1</p>			
Part No.	103068	Ref. No.	A042200
description	burner cap ø 100mm		
accessories for	103068		
	Part No.	103067	Ref. No. A042000
	burner ring for burner cap ø 100mm		
	Part No.	104102	Ref. No. A041800
	burner head for burner cap ø 100mm ext. ø 130		
	Part No.	104103	Ref. No. A041600
	burner holder suitable for burner ø100mm with nozzle holder		





 <p>1</p>			
Part No.	103066	Ref. No.	A042100
description	burner cap ø 80mm		
accessories for	103066		
	Part No.	103065	Ref. No. A041900
	burner ring for burner cap ø 80mm		
	Part No.	104100	Ref. No. A041700
	burner head for burner cap ø 80mm		
	Part No.	104101	Ref. No. A041500
	burner holder for burner cap ø 80mm with nozzle holder with mixing sleeve		

 <p>1</p>			
Part No.	104102	Ref. No.	A041800
description	burner head for burner cap ø 100mm ext. ø 130		





 <p>1</p>			
Part No.	104100	Ref. No.	A041700
description	burner head for burner cap ø 80mm		
accessories for	104100		
	Part No.	103065	Ref. No. A041900
	burner ring for burner cap ø 80mm		
	Part No.	103066	Ref. No. A042100
	burner cap ø 80mm		
	Part No.	104103	Ref. No. A041600
	burner holder suitable for burner ø100mm with nozzle holder		

 <p>1</p>			
Part No.	104101	Ref. No.	A041500
description	burner holder for burner cap ø 80mm with nozzle holder with mixing sleeve		
accessories for	104101		
	Part No.	103065	Ref. No. A041900
	burner ring for burner cap ø 80mm		
	Part No.	103066	Ref. No. A042100
	burner cap ø 80mm		
	Part No.	104100	Ref. No. A041700
	burner head for burner cap ø 80mm		

 <p>1</p>			
Part No.	104103	Ref. No.	A041600
description	burner holder suitable for burner ø100mm with nozzle holder		
accessories for	104103		
	Part No.	103067	Ref. No. A042000
	burner ring for burner cap ø 100mm		
	Part No.	103068	Ref. No. A042200
	burner cap ø 100mm		
	Part No.	104102	Ref. No. A041800
	burner head for burner cap ø 100mm ext. ø 130		

 <p>1</p>			
Part No.	103067	Ref. No.	A042000
description	burner ring for burner cap ø 100mm		
accessories for	103067		
	Part No.	103068	Ref. No. A042200
	burner cap ø 100mm		
	Part No.	104102	Ref. No. A041800
	burner head for burner cap ø 100mm ext. ø 130		
	Part No.	104103	Ref. No. A041600
	burner holder suitable for burner ø100mm with nozzle holder		





			
1			
Part No.	103065	Ref. No.	A041900
description	burner ring for burner cap ø 80mm		
accessories for	103065		
	Part No.	103066	Ref. No. A042100
	burner cap ø 80mm		
	Part No.	104100	Ref. No. A041700
	burner head for burner cap ø 80mm		
	Part No.	104101	Ref. No. A041500
	burner holder for burner cap ø 80mm with nozzle holder with mixing sleeve		

SABAF

2 series - standard



			
1			
Part No.	105993	Ref. No.	001U588
description	burner cap 1.8kW ø 75mm bright finish		

			
1			
Part No.	105054	Ref. No.	001U589
description	burner cap 3kW ø 100mm H 3.5mm bright finish		
accessories for	105054		
	Part No.	105058	Ref. No. —
	burner head 3kW for igniter ø 6mm for burner cap ø 100mm		
	Part No.	105059	Ref. No. —
	burner lower part 3kW for igniter ø 6mm for thermocouple ø 6mm without nozzle for burner cap ø 100mm		

2 series - flat skirt version

			
1			
Part No.	105993	Ref. No.	001U588
description	burner cap 1.8kW ø 75mm bright finish		

			
1			
Part No.	105994	Ref. No.	001U587 0210003003
description	burner cap 1kW ø 55mm bright finish		





			
1			
Part No.	105054	Ref. No.	001U589
description	burner cap 3kW ø 100mm H 3.5mm bright finish		
accessories for	105054		
	Part No.	105058	Ref. No. —
	burner head 3kW for igniter ø 6mm for burner cap ø 100mm		
	Part No.	105059	Ref. No. —
	burner lower part 3kW for igniter ø 6mm for thermocouple ø 6mm without nozzle for burner cap ø 100mm		

			
1			
Part No.	105995	Ref. No.	001Q808
description	burner head 1.8kW for burner cap ø 75mm		

			
1			
Part No.	105996	Ref. No.	001Q805
description	burner head 1kW for burner cap ø 55mm		

			
1			
Part No.	105992	Ref. No.	001Q811
description	burner head 3kW for burner cap ø 100mm		

triple ring burner series - standard version

			
1			
Part No.	105063	Ref. No.	001U591
description	burner cap 3.6kW ø 131mm H 4mm mounting pos. outer		
accessories for	105063		
	Part No.	105064	Ref. No. 001U590
	burner cap 3.6kW ø 61mm H 6.5mm mounting pos. inner bright finish		
	Part No.	105065	Ref. No. —
	burner head 3.6kW for burner cap ø 61/131mm		
	Part No.	105717	Ref. No. —
	burner lower part 3.6kW for igniter ø 6mm for thermocouple ø 6mm with nozzle ø1.35mm ID ø 64mm for burner cap ø 61/131mm		
	Part No.	105922	Ref. No. —
	burner lower part 3.6kW for igniter ø 6mm for thermocouple ø 6mm with nozzle ø1.35mm ID ø 75mm for burner cap ø 61/131mm		







 <p>1</p>			
Part No.	105064	Ref. No.	001U590
description	burner cap 3.6kW ø 61mm H 6.5mm mounting pos. inner bright finish		
accessories for	105064		
	Part No.	105063	Ref. No. 001U591
	burner cap 3.6kW ø 131mm H 4mm mounting pos. outer		
	Part No.	105065	Ref. No. —
	burner head 3.6kW for burner cap ø 61/131mm		
	Part No.	105717	Ref. No. —
	burner lower part 3.6kW for igniter ø 6mm for thermocouple ø 6mm with nozzle ø1.35mm ID ø 64mm for burner cap ø 61/131mm		
	Part No.	105922	Ref. No. —
	burner lower part 3.6kW for igniter ø 6mm for thermocouple ø 6mm with nozzle ø1.35mm ID ø 75mm for burner cap ø 61/131mm		

triple ring burner series - flat skirt version			
 <p>1</p>			
Part No.	105063	Ref. No.	001U591
description	burner cap 3.6kW ø 131mm H 4mm mounting pos. outer		
accessories for	105063		
	Part No.	105064	Ref. No. 001U590
	burner cap 3.6kW ø 61mm H 6.5mm mounting pos. inner bright finish		
	Part No.	105065	Ref. No. —
	burner head 3.6kW for burner cap ø 61/131mm		
	Part No.	105717	Ref. No. —
	burner lower part 3.6kW for igniter ø 6mm for thermocouple ø 6mm with nozzle ø1.35mm ID ø 64mm for burner cap ø 61/131mm		
	Part No.	105922	Ref. No. —
	burner lower part 3.6kW for igniter ø 6mm for thermocouple ø 6mm with nozzle ø1.35mm ID ø 75mm for burner cap ø 61/131mm		

 <p>1</p>			
Part No.	105064	Ref. No.	001U590
description	burner cap 3.6kW ø 61mm H 6.5mm mounting pos. inner bright finish		
accessories for	105064		
	Part No.	105063	Ref. No. 001U591
	burner cap 3.6kW ø 131mm H 4mm mounting pos. outer		
	Part No.	105065	Ref. No. —
	burner head 3.6kW for burner cap ø 61/131mm		
	Part No.	105717	Ref. No. —
	burner lower part 3.6kW for igniter ø 6mm for thermocouple ø 6mm with nozzle ø1.35mm ID ø 64mm for burner cap ø 61/131mm		
	Part No.	105922	Ref. No. —
	burner lower part 3.6kW for igniter ø 6mm for thermocouple ø 6mm with nozzle ø1.35mm ID ø 75mm for burner cap ø 61/131mm		

 <p>1</p>			
Part No.	105991	Ref. No.	001Q815 EOL01A192G
description	burner head for burner cap ø 131mm		

producer-specific hob burners
BARTSCHER
70, 85 (old) series

 <p>1</p>			
Part No.	104056	Ref. No.	2510140
description	air mixing sleeve		
accessories for	104056		
	Part No.	105291	Ref. No. N/A
	burner head for burner cap ø 70mm 3.5kW		
	Part No.	105292	Ref. No. 2510601
	burner cap ø 70mm 3.5kW		
	Part No.	105293	Ref. No. 2510602
	venturi		
	Part No.	105294	Ref. No. 2510603
	burner holder with nozzle holder		
	Part No.	105296	Ref. No. —
	cover for pilot burner suitable for 700 series Qty 1 pcs		

 <p>1</p>			
Part No.	104053	Ref. No.	2510134
description	burner head for burner cap ø 125mm		









 <p>1</p>			
Part No.	104052	Ref. No.	2510136
description	burner head for burner cap ø 80mm		

 <p>1</p>			
Part No.	105198	Ref. No.	2530085
description	fastening angle		







70. 90 (TopLine) series







Part No.	105289	Ref. No.	2519002
description	air mixing sleeve L 50mm ED ø 45mm ID ø 42mm aluminium		
accessories for	105289		
	Part No.	105280	Ref. No. 2510351
	burner head C for burner cap ø 80mm 3.5kW		
	Part No.	105281	Ref. No. 2510352
	burner cap C ø 80mm 3.5kW with central hole ID ø 32mm		
	Part No.	105282	Ref. No. —
	venturi C for burner cap ø 80mm 3.5kW		
	Part No.	105283	Ref. No. 2510354
	burner head D for burner cap ø 105mm 5.6kW		
	Part No.	105284	Ref. No. 2510355
	burner cap ID ø 54mm D ø 105mm 5.6kW with central hole		
	Part No.	105285	Ref. No. 2510353
	venturi D for burner cap ø 105mm 5.6kW		
	Part No.	105286	Ref. No. 2510357
	burner head E for burner cap ø 125mm 7kW		
	Part No.	105287	Ref. No. 2510341 2510358
	burner cap E ø 125mm 7kW with central hole		
	Part No.	105288	Ref. No. 2510340 2510356
	venturi E for burner cap ø 125mm 7kW		
	Part No.	105290	Ref. No. 021647
	nozzle holder nozzle mounting M11x1		







Part No.	105281	Ref. No.	2510352
description	burner cap C ø 80mm 3.5kW with central hole ID ø 32mm		
accessories for	105281		
	Part No.	105280	Ref. No. 2510351
	burner head C for burner cap ø 80mm 3.5kW		
	Part No.	105282	Ref. No. —
	venturi C for burner cap ø 80mm 3.5kW		
	Part No.	105289	Ref. No. 2519002
	air mixing sleeve L 50mm ED ø 45mm ID ø 42mm aluminium		
	Part No.	105290	Ref. No. 021647
	nozzle holder nozzle mounting M11x1		



Part No.	105287	Ref. No.	2510341 2510358
description	burner cap E ø 125mm 7kW with central hole		
accessories for	105287		
	Part No.	105286	Ref. No. 2510357
	burner head E for burner cap ø 125mm 7kW		
	Part No.	105288	Ref. No. 2510340 2510356
	venturi E for burner cap ø 125mm 7kW		
	Part No.	105289	Ref. No. 2519002
	air mixing sleeve L 50mm ED ø 45mm ID ø 42mm aluminium		
	Part No.	105290	Ref. No. 021647
	nozzle holder nozzle mounting M11x1		



Part No.	105284	Ref. No.	2510355
description	burner cap ID ø 54mm D ø 105mm 5.6kW with central hole		
accessories for	105284		
	Part No.	105283	Ref. No. 2510354
	burner head D for burner cap ø 105mm 5.6kW		
	Part No.	105285	Ref. No. 2510353
	venturi D for burner cap ø 105mm 5.6kW		
	Part No.	105289	Ref. No. 2519002
	air mixing sleeve L 50mm ED ø 45mm ID ø 42mm aluminium		
	Part No.	105290	Ref. No. 021647
	nozzle holder nozzle mounting M11x1		







Part No.	105280	Ref. No.	2510351
description	burner head C for burner cap ø 80mm 3.5kW		
accessories for	105280		
	Part No.	105281	Ref. No. 2510352
	burner cap C ø 80mm 3.5kW with central hole ID ø 32mm		
	Part No.	105282	Ref. No. —
	venturi C for burner cap ø 80mm 3.5kW		
	Part No.	105289	Ref. No. 2519002
	air mixing sleeve L 50mm ED ø 45mm ID ø 42mm aluminium		





Table continues overleaf



accessories for	105280		
	Part No.	105290	Ref. No. 021647
	nozzle holder nozzle mounting M11x1		



 <p>1</p>			
Part No.	105283	Ref. No.	2510354
description	burner head D for burner cap ø 105mm 5.6kW		
accessories for	105283		
	Part No.	105284	Ref. No. 2510355
	burner cap ID ø 54mm D ø 105mm 5.6kW with central hole		
	Part No.	105285	Ref. No. 2510353
	venturi D for burner cap ø 105mm 5.6kW		
	Part No.	105289	Ref. No. 2519002
	air mixing sleeve L 50mm ED ø 45mm ID ø 42mm aluminium		
	Part No.	105290	Ref. No. 021647
	nozzle holder nozzle mounting M11x1		

 <p>1</p>			
Part No.	105286	Ref. No.	2510357
description	burner head E for burner cap ø 125mm 7kW		
accessories for	105286		
	Part No.	105287	Ref. No. 2510341 2510358
	burner cap E ø 125mm 7kW with central hole		
	Part No.	105288	Ref. No. 2510340 2510356
	venturi E for burner cap ø 125mm 7kW		
	Part No.	105289	Ref. No. 2519002
	air mixing sleeve L 50mm ED ø 45mm ID ø 42mm aluminium		
	Part No.	105290	Ref. No. 021647
	nozzle holder nozzle mounting M11x1		





 <p>1</p>			
Part No.	105290	Ref. No.	021647
description	nozzle holder nozzle mounting M11x1		
accessories for	105290		
	Part No.	105280	Ref. No. 2510351
	burner head C for burner cap ø 80mm 3.5kW		
	Part No.	105281	Ref. No. 2510352
	burner cap C ø 80mm 3.5kW with central hole ID ø 32mm		
	Part No.	105282	Ref. No. —
	venturi C for burner cap ø 80mm 3.5kW		







accessories for	105290		
	Part No.	105283	Ref. No. 2510354
	burner head D for burner cap ø 105mm 5.6kW		
	Part No.	105284	Ref. No. 2510355
	burner cap ID ø 54mm D ø 105mm 5.6kW with central hole		
	Part No.	105285	Ref. No. 2510353
	venturi D for burner cap ø 105mm 5.6kW		
	Part No.	105286	Ref. No. 2510357
	burner head E for burner cap ø 125mm 7kW		
	Part No.	105287	Ref. No. 2510341 2510358
	burner cap E ø 125mm 7kW with central hole		
	Part No.	105288	Ref. No. 2510340 2510356
	venturi E for burner cap ø 125mm 7kW		
	Part No.	105289	Ref. No. 2519002
	air mixing sleeve L 50mm ED ø 45mm ID ø 42mm aluminium		



 <p>1</p>			
Part No.	104452	Ref. No.	2510350
description	venturi C for burner cap ø 80mm 3.5kW		



 <p>1</p>			
Part No.	105285	Ref. No.	2510353
description	venturi D for burner cap ø 105mm 5.6kW		
accessories for	105285		
	Part No.	105283	Ref. No. 2510354
	burner head D for burner cap ø 105mm 5.6kW		
	Part No.	105284	Ref. No. 2510355
	burner cap ID ø 54mm D ø 105mm 5.6kW with central hole		
	Part No.	105289	Ref. No. 2519002
	air mixing sleeve L 50mm ED ø 45mm ID ø 42mm aluminium		
	Part No.	105290	Ref. No. 021647
	nozzle holder nozzle mounting M11x1		









			
1			
Part No.	105288	Ref. No.	2510340 2510356
description	venturi E for burner cap ø 125mm 7kW		
accessories for	105288		
	Part No.	105286	Ref. No. 2510357
	burner head E for burner cap ø 125mm 7kW		
	Part No.	105287	Ref. No. 2510341 2510358
	burner cap E ø 125mm 7kW with central hole		
	Part No.	105289	Ref. No. 2519002
	air mixing sleeve L 50mm ED ø 45mm ID ø 42mm aluminium		
	Part No.	105290	Ref. No. 021647
	nozzle holder nozzle mounting M11x1		

70N series			
			
1			
Part No.	104056	Ref. No.	2510140
description	air mixing sleeve		
accessories for	104056		
	Part No.	105291	Ref. No. N/A
	burner head for burner cap ø 70mm 3.5kW		
	Part No.	105292	Ref. No. 2510601
	burner cap ø 70mm 3.5kW		
	Part No.	105293	Ref. No. 2510602
	venturi		
	Part No.	105294	Ref. No. 2510603
	burner holder with nozzle holder		
	Part No.	105296	Ref. No. —
	cover for pilot burner suitable for 700 series Qty 1 pcs		



			
1			
Part No.	105292	Ref. No.	2510601
description	burner cap ø 70mm 3.5kW		
accessories for	105292		
	Part No.	104056	Ref. No. 2510140
	air mixing sleeve		
	Part No.	105291	Ref. No. N/A
	burner head for burner cap ø 70mm 3.5kW		

accessories for	105292		
	Part No.	105293	Ref. No. 2510602
	venturi		
	Part No.	105294	Ref. No. 2510603
	burner holder with nozzle holder		
	Part No.	105296	Ref. No. —
	cover for pilot burner suitable for 700 series Qty 1 pcs		











			
1			
Part No.	105291	Ref. No.	N/A
description	burner head for burner cap ø 70mm 3.5kW		
accessories for	105291		
	Part No.	104056	Ref. No. 2510140
	air mixing sleeve		
	Part No.	105292	Ref. No. 2510601
	burner cap ø 70mm 3.5kW		
	Part No.	105293	Ref. No. 2510602
	venturi		
	Part No.	105294	Ref. No. 2510603
	burner holder with nozzle holder		
	Part No.	105296	Ref. No. —
	cover for pilot burner suitable for 700 series Qty 1 pcs		





			
1			
Part No.	105294	Ref. No.	2510603
description	burner holder with nozzle holder		
accessories for	105294		
	Part No.	104056	Ref. No. 2510140
	air mixing sleeve		
	Part No.	105291	Ref. No. N/A
	burner head for burner cap ø 70mm 3.5kW		
	Part No.	105292	Ref. No. 2510601
	burner cap ø 70mm 3.5kW		
	Part No.	105293	Ref. No. 2510602
	venturi		
	Part No.	105296	Ref. No. —
	cover for pilot burner suitable for 700 series Qty 1 pcs		







 <p>1</p>			
Part No.	105293	Ref. No.	2510602
description	venturi		
accessories for	105293		
	Part No.	104056	Ref. No. 2510140
air mixing sleeve			
	Part No.	105291	Ref. No. N/A
burner head for burner cap ø 70mm 3.5kW			
	Part No.	105292	Ref. No. 2510601
burner cap ø 70mm 3.5kW			
	Part No.	105294	Ref. No. 2510603
burner holder with nozzle holder			
	Part No.	105296	Ref. No. —
cover for pilot burner suitable for 700 series Qty 1 pcs			

90 (old) series

 <p>1</p>			
Part No.	104051	Ref. No.	2510197
description	air mixing sleeve		
accessories for	104051		
	Part No.	103030	Ref. No. 2510190
burner cap C ø 85mm 3.5kW			
	Part No.	103031	Ref. No. 2510193
burner cap D ø 115mm 5.5kW			
	Part No.	103032	Ref. No. —
burner cap E ø 125mm 7kW with central hole			
	Part No.	104045	Ref. No. 2510189
burner head C for burner cap ø 85mm 3.5kW			
	Part No.	104046	Ref. No. 2510192
burner head D for burner cap ø 115mm 5.5kW			
	Part No.	104047	Ref. No. 2510194
burner head E for burner cap ø 125mm 7kW			
	Part No.	104048	Ref. No. 2510195
venturi C for burner cap ø 85mm 3.5kW			
	Part No.	104049	Ref. No. 2510201
venturi D for burner cap ø 115mm 5.5kW			
	Part No.	104050	Ref. No. 2510202
venturi E for burner cap ø 125mm 7kW			

 <p>1</p>			
Part No.	103030	Ref. No.	2510190
description	burner cap C ø 85mm 3.5kW		
accessories for	103030		
	Part No.	104045	Ref. No. 2510189
burner head C for burner cap ø 85mm 3.5kW			
	Part No.	104048	Ref. No. 2510195
venturi C for burner cap ø 85mm 3.5kW			
	Part No.	104051	Ref. No. 2510197
air mixing sleeve			

 <p>1</p>			
Part No.	103031	Ref. No.	2510193
description	burner cap D ø 115mm 5.5kW		
accessories for	103031		
	Part No.	104046	Ref. No. 2510192
burner head D for burner cap ø 115mm 5.5kW			
	Part No.	104049	Ref. No. 2510201
venturi D for burner cap ø 115mm 5.5kW			
	Part No.	104051	Ref. No. 2510197
air mixing sleeve			



 <p>1</p>			
Part No.	104045	Ref. No.	2510189
description	burner head C for burner cap ø 85mm 3.5kW		
accessories for	104045		
	Part No.	103030	Ref. No. 2510190
burner cap C ø 85mm 3.5kW			
	Part No.	104048	Ref. No. 2510195
venturi C for burner cap ø 85mm 3.5kW			
	Part No.	104051	Ref. No. 2510197
air mixing sleeve			



			
1			
Part No.	104046	Ref. No.	2510192
description	burner head D for burner cap ø 115mm 5.5kW		
accessories for	104046		
	Part No.	103031	Ref. No. 2510193
	burner cap D ø 115mm 5.5kW		
	Part No.	104049	Ref. No. 2510201
	venturi D for burner cap ø 115mm 5.5kW		
	Part No.	104051	Ref. No. 2510197
	air mixing sleeve		

			
1			
Part No.	104047	Ref. No.	2510194
description	burner head E for burner cap ø 125mm 7kW		
accessories for	104047		
	Part No.	103032	Ref. No. —
	burner cap E ø 125mm 7kW with central hole		
	Part No.	104050	Ref. No. 2510202
	venturi E for burner cap ø 125mm 7kW		
	Part No.	104051	Ref. No. 2510197
	air mixing sleeve		

			
1			
Part No.	104048	Ref. No.	2510195
description	venturi C for burner cap ø 85mm 3.5kW		
accessories for	104048		
	Part No.	103030	Ref. No. 2510190
	burner cap C ø 85mm 3.5kW		
	Part No.	104045	Ref. No. 2510189
	burner head C for burner cap ø 85mm 3.5kW		
	Part No.	104051	Ref. No. 2510197
	air mixing sleeve		

			
1			
Part No.	104049	Ref. No.	2510201
description	venturi D for burner cap ø 115mm 5.5kW		
accessories for	104049		
	Part No.	103031	Ref. No. 2510193
	burner cap D ø 115mm 5.5kW		
	Part No.	104046	Ref. No. 2510192
	burner head D for burner cap ø 115mm 5.5kW		
	Part No.	104051	Ref. No. 2510197
	air mixing sleeve		

			
1			
Part No.	104050	Ref. No.	2510202
description	venturi E for burner cap ø 125mm 7kW		
accessories for	104050		
	Part No.	103032	Ref. No. —
	burner cap E ø 125mm 7kW with central hole		
	Part No.	104047	Ref. No. 2510194
	burner head E for burner cap ø 125mm 7kW		
	Part No.	104051	Ref. No. 2510197
	air mixing sleeve		

Snack series

			
1			
Part No.	106379	Ref. No.	N/A
description	air mixing tube for burner cap ø 80mm L 23mm D1 ø 20mm D2 ø 15.6mm D3 ø 14mm		









			
1			
Part No.	103068	Ref. No.	A042200
description	burner cap ø 100mm		
accessories for	103068		
	Part No.	103067	Ref. No. A042000
	burner ring for burner cap ø 100mm		
	Part No.	104102	Ref. No. A041800
	burner head for burner cap ø 100mm ext. ø 130		





Table continues overleaf







accessories for	103068		
	Part No.	104103	Ref. No. A041600
burner holder suitable for burner ø100mm with nozzle holder			

accessories for	104101		
	Part No.	104100	Ref. No. A041700
burner head for burner cap ø 80mm			





1			
Part No.	103066	Ref. No.	A042100
description	burner cap ø 80mm		
accessories for	103066		
	Part No.	103065	Ref. No. A041900
burner ring for burner cap ø 80mm			
	Part No.	104100	Ref. No. A041700
burner head for burner cap ø 80mm			
	Part No.	104101	Ref. No. A041500
burner holder for burner cap ø 80mm with nozzle holder with mixing sleeve			



1			
Part No.	104103	Ref. No.	A041600
description	burner holder suitable for burner ø100mm with nozzle holder		
accessories for	104103		
	Part No.	103067	Ref. No. A042000
burner ring for burner cap ø 100mm			
	Part No.	103068	Ref. No. A042200
burner cap ø 100mm			
	Part No.	104102	Ref. No. A041800
burner head for burner cap ø 100mm ext. ø 130			

1			
Part No.	104102	Ref. No.	A041800
description	burner head for burner cap ø 100mm ext. ø 130		

1			
Part No.	103067	Ref. No.	A042000
description	burner ring for burner cap ø 100mm		
accessories for	103067		
	Part No.	103068	Ref. No. A042200
burner cap ø 100mm			
	Part No.	104102	Ref. No. A041800
burner head for burner cap ø 100mm ext. ø 130			
	Part No.	104103	Ref. No. A041600
burner holder suitable for burner ø100mm with nozzle holder			

1			
Part No.	104100	Ref. No.	A041700
description	burner head for burner cap ø 80mm		
accessories for	104100		
	Part No.	103065	Ref. No. A041900
burner ring for burner cap ø 80mm			
	Part No.	103066	Ref. No. A042100
burner cap ø 80mm			
	Part No.	104103	Ref. No. A041600
burner holder suitable for burner ø100mm with nozzle holder			

1			
Part No.	103065	Ref. No.	A041900
description	burner ring for burner cap ø 80mm		
accessories for	103065		
	Part No.	103066	Ref. No. A042100
burner cap ø 80mm			
	Part No.	104100	Ref. No. A041700
burner head for burner cap ø 80mm			
	Part No.	104101	Ref. No. A041500
burner holder for burner cap ø 80mm with nozzle holder with mixing sleeve			

1			
Part No.	104101	Ref. No.	A041500
description	burner holder for burner cap ø 80mm with nozzle holder with mixing sleeve		
accessories for	104101		
	Part No.	103065	Ref. No. A041900
burner ring for burner cap ø 80mm			
	Part No.	103066	Ref. No. A042100
burner cap ø 80mm			



accessories

pan supports



1

Part No.	210245	Ref. No.	N/A
description	pan support W 370mm L 580mm		

bar burners

bar burners



1

Part No.	105443	Ref. No.	024075
description	bar burner ø 40mm Wmm Hmm L 490mm flange width 43mm flange length 43mm pasta cooker		

solid top burners



1

Part No.	105251	Ref. No.	02510069
description	solid top burner ø 120mm H 102mm L 340mm		

accessories

nozzle holders



1

Part No.	104724	Ref. No.	010037
description	nozzle holder		



1

Part No.	105290	Ref. No.	021647
description	nozzle holder nozzle mounting M11x1		
accessories for	105290		
	Part No.	105280	Ref. No. 2510351
	burner head C for burner cap ø 80mm 3.5kW		
	Part No.	105281	Ref. No. 2510352
	burner cap C ø 80mm 3.5kW with central hole ID ø 32mm		
	Part No.	105283	Ref. No. 2510354
	burner head D for burner cap ø 105mm 5.6kW		
	Part No.	105284	Ref. No. 2510355
	burner cap ID ø 54mm D ø 105mm 5.6kW with central hole		
	Part No.	105285	Ref. No. 2510353
	venturi D for burner cap ø 105mm 5.6kW		
	Part No.	105286	Ref. No. 2510357
	burner head E for burner cap ø 125mm 7kW		
	Part No.	105287	Ref. No. 2510341 2510358
	burner cap E ø 125mm 7kW with central hole		
	Part No.	105288	Ref. No. 2510340 2510356
	venturi E for burner cap ø 125mm 7kW		
	Part No.	105289	Ref. No. 2519002
	air mixing sleeve L 50mm ED ø 45mm ID ø 42mm aluminium		

miscellaneous

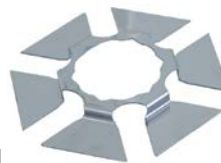

1

Part No.	105501	Ref. No.	136069110
description	flame spreader		



gas nozzles

main nozzles

gas nozzles M6x0.75



1

Part No.	104778	Ref. No.	003090429
description	gas injector thread M6x0.75 WS 7 bore ø 1.45mm		

gas nozzles M9x1



1

Part No.	100957	Ref. No.	016118
description	gas injector thread M9x1 WS 10 bore ø 0.8mm		
For models:	105.014, 105014		



1

Part No.	100956	Ref. No.	016123
description	gas injector thread M9x1 WS 10 bore ø 1.3mm		
For models:	105014		

gas nozzles (other)



1

Part No.	101942	Ref. No.	051123010
description	gas injector thread M6x1 natural gas WS 10 bore ø 1.25mm		



1

Part No.	100999	Ref. No.	051123009
description	gas injector LPG		

pilot burner nozzles

pilot burner nozzles SIT

100 series



1

Part No.	100245	Ref. No.	016106
description	pilot burner nozzle LPG code 20 bore ø 0.2mm Qty 1 pcs thread M8x0.75		
For models:	105014		

auxiliary gas parts

screw connections

union screws



1

Part No.	102506	Ref. No.	021295
description	screw connection thread M10x1 Qty 5 pcs for igniter		

equipment-specific units

for meat mincers

gearboxes



1

Part No.	699296	Ref. No.	240309-2 A062101
description	gearbox ø 36mm H 60mm model K5		

for dough mixers

gearboxes



1

Part No.	699296	Ref. No.	240309-2 A062101
description	gearbox ø 36mm H 60mm model K5		



for planetary mixers

gearboxes



1

Part No.	699296	Ref. No.	240309-2 A062101
description	gearbox ø 36mm H 60mm model K5		

beaters



1

Part No.	699393	Ref. No.	A150017
description	whisk shaft intake ø 12.7mm H 185mm suitable for KitchenAid		

for hand blenders

couplings



1

Part No.	699008	Ref. No.	SL1496
description	coupling D1 ø 20mm D2 ø 23mm int. ø 1 8mm int. ø 2 8mm L 33.5mm FM3		
accessories for	699008		
	Part No.	697417	Ref. No. —
description	grub screw thread M5 L 10mm stainless steel DIN 914/ISO 4027 WS 2.5 with spike Qty 1 pcs		

for ice-cube maker

cutting grid



1

Part No.	480100	Ref. No.	0481925998215
description	cutting grid for ice-cube maker L 350mm W 285mm H 40mm		

for espresso machines

brewing units

filter holder gaskets

O-rings



1

Part No.	510409	Ref. No.	0929046
description	O-ring EPDM thickness 5.34mm ID ø 56.52mm Qty 1 pcs		

for pour machines

coffee pots



1

Part No.	960004	Ref. No.	A210.142
description	coffee pot 1.8l plastic/steel		

coffee filters

paper filters

basket filters



1

Part No.	960100	Ref. No.	190013
description	paper filter for coffee makers D1 ø 90mm D2 ø 250mm Qty 1000 pcs		



filter pans

filter pans

BARTSCHER



1

Part No.	950000	Ref. No.	A038004 A0ND003+A040583
description	filter pan aluminium with percolator tube edition since year of construction 10/2007 ø 205mm H 50mm suitable for PRO 40T		
For models:	A190141		

drain taps

drain taps



1

Part No.	531128	Ref. No.	A0ND029
description	outlet tap complete tube ø 19mm pipe length 22mm thread M15x1 black		
For models:	A190141, A190161		
spare parts for	531128		
	Part No.	531129	Ref. No. A0ND032
	gasket for outlet tap H 29mm ø 14.5mm suitable for BARTSCHER		



1

Part No.	531151	Ref. No.	A040580
description	outlet tap tube ø 22.5mm pipe length 52mm thread M16 black		

components



1

Part No.	531129	Ref. No.	A0ND032
description	gasket for outlet tap H 29mm ø 14.5mm suitable for BARTSCHER		
For models:	A190141, A190161		

liquid level pipes

liquid level pipes



1

Part No.	531131	Ref. No.	A0ND043
description	water level tube ED ø 12mm ID ø 10mm H 202mm for coffee machine		
For models:	A190141		
accessories for	531131		
	Part No.	504297	Ref. No. A0ND036
	gasket for water level tube ED ø 13mm ID ø 6mm silicone		



1

Part No.	531130	Ref. No.	A039690
description	water level tube ED ø 12mm ID ø 10mm H 262mm for coffee machine		
For models:	A190161		
accessories for	531130		
	Part No.	504297	Ref. No. A0ND036
	gasket for water level tube ED ø 13mm ID ø 6mm silicone		

accessories

gaskets



1

Part No.	504297	Ref. No.	A0ND036
description	gasket for water level tube ED ø 13mm ID ø 6mm silicone		
For models:	A190141, A190161		



miscellaneous



1

Part No.	531308	Ref. No.	A039688 A040627
description	pipe L 335mm W 43mm tube ø 9mm		
For models:	A190161		



1

Part No.	531208	Ref. No.	A0ND038
description	reset pin L 107mm W 33mm suitable for BARTSCHER		
For models:	A190141, A190161		

for crepes makers

accessories



1

Part No.	697850	Ref. No.	010444614
description	batter spreader for crepes maker L 320mm W 275mm wood		
For models:	104447		



1

Part No.	694339	Ref. No.	010444615
description	crêpe spatula L 430mm W 57mm thickness 4mm wood		
For models:	104447		

for deep fryers

lids



1

Part No.	970745	Ref. No.	016240415
description	lid for fryer SS L 295mm W 215mm H 7mm		

basket holders



1

Part No.	970744	Ref. No.	016240426
description	basket support for fryer L 139mm W 44mm H 8mm suitable for BARTSCHER		

miscellaneous



1

Part No.	692498	Ref. No.	A040572
description	mounting set fryer		
For models:	A150107, A150207, A150671		

for grills

sumps

1

Part No.		Ref. No.	A016490
description	grease collecting tray		

1

Part No.	692237	Ref. No.	A041541
description	grease collecting tray L 357mm W 37mm H 29mm		
For models:	A150674		

for hot dog machines

water containers



1

Part No.	693169	Ref. No.	A042233034
description	water container for hot dog machine ø 205mm H 65mm		

for panini grill

guiding pieces



1

Part No.	699289	Ref. No.	A042575
description	support bracket mounting pos. rear L 35mm W 14mm H 12.5mm		
For models:	A150671, A150674		

for contact grills

miscellaneous



1

Part No.	701381	Ref. No.	A041543
description	handle L 350mm W 406mm H 20mm Panini		
For models:	A150674		



1

Part No.	692239	Ref. No.	A040548
description	spindle for contact grill L 404mm ø 12mm		
For models:	A150674		

for pizza ovens

firebricks



1

Part No.	850015	Ref. No.	0300180131
description	firebrick L 620mm W 305mm H 25mm delivery freight forwarding company only		



1

Part No.	850113	Ref. No.	022552
description	firebrick L 620mm W 610mm H 25mm delivery freight forwarding company only		

for rechauds

warming plates

warming plates



1

Part No.	693132	Ref. No.	A000800
description	warming plate plate size 280x155x8mm with handle suitable for PLA5/PLA12		



for rice cookers

			
1			
Part No.	694342	Ref. No.	A01505131
description	silicon insert for rice cooker ø 293mm thickness 1.3mm		

for saladettes

guide bars

			
1			
Part No.	693176	Ref. No.	048234001
description	guide bar for saladette		

for salamander grills

			
1			
Part No.	692729	Ref. No.	02013882
description	belt for salamander grill L 385mm W 13mm Hmm ED ømm ID ømm		

			
1			
Part No.	697836	Ref. No.	A039868
description	gear wheel teeth 16 shaft intake ø 8mm ø 35mm tooth width 3mm W 18mm for toaster		
For models:	151510		

			
1			
Part No.	692728	Ref. No.	02013873
description	spindle for salamander grill L 493mm Wmm Hmm ED ø 5mm ID ømm		

for sliding doors

door guides

			
1			
Part No.		Ref. No.	041615
description	guide for sliding door aluminium		

for dishwashers

containers

dosing containers



			
1			
Part No.	361255	Ref. No.	0481241867008
description	rinse aid container		

salt tanks





			
1			
Part No.	510929	Ref. No.	011628 012247
description	salt tank ø 120mm H 117mm hose ø 10mm mounting ø 70mm overall height 157mm		
spare parts for	510929		
	Part No.	506015	Ref. No. —
	O-ring EPDM thickness 3.53mm ID ø 39.69mm Qty 1 pcs		
	Part No.	510018	Ref. No. —
	nut ø 92mm H 10.5mm for salt tank ID ø 64mm		
	Part No.	524177	Ref. No. —
	lid ø 69mm H 20mm for salt tank ID ø 50mm		

Table continues overleaf



accessories for 510929	
	Part No. 510071 Ref. No. — flat gasket rubber ED ø 81mm ID ø 68mm thickness 3mm for salt tank Qty 1 pcs
	Part No. 510654 Ref. No. — gasket H 6mm D1 ø 82mm D2 ø 68mm
	Part No. 510883 Ref. No. — gasket rubber ED ø 86mm ID ø 66mm thickness 2mm for salt tank Qty 1 pcs



Part No. 510032	Ref. No. 0406998
description salt tank without gasket new model	
spare parts for 510032	
	Part No. 506015 Ref. No. — O-ring EPDM thickness 3.53mm ID ø 39.69mm Qty 1 pcs
	Part No. 510018 Ref. No. — nut ø 92mm H 10.5mm for salt tank ID ø 64mm
	Part No. 510071 Ref. No. — flat gasket rubber ED ø 81mm ID ø 68mm thickness 3mm for salt tank Qty 1 pcs
	Part No. 524177 Ref. No. — lid ø 69mm H 20mm for salt tank ID ø 50mm

boilers

boilers for dishwashers

	1
Part No. 518379	Ref. No. 0982017
description boiler	





hood mechanics for dishwashers

guide bars

	1
Part No. 693174	Ref. No. 058233013
description guide bar	



air traps

air traps

	1
Part No. 510103	Ref. No. 011500 011672
description air trap L 85mm W 20mm H 80mm hose ø 6mm plastic	
spare parts for 510103	
	Part No. 505045 Ref. No. — O-ring EPDM thickness 1.78mm ID ø 5.28mm Qty 1 pcs
	Part No. 505094 Ref. No. — air trap
	Part No. 510016 Ref. No. 011498 011675 020696 eye bolt for rinse aid container connection
	Part No. 510105 Ref. No. 011674 hose connector for air trap

	1
Part No. 518200	Ref. No. 0984005
description air trap ø 34mm H 78mm hose ø 6mm plastic	
spare parts for 518200	
	Part No. 504618 Ref. No. — O-ring EPDM thickness 2.62mm ID ø 15.54mm Qty 1 pcs
	Part No. 510075 Ref. No. — flat gasket rubber ED ø 22mm ID ø 13mm thickness 1.5mm Qty 1 pcs
	Part No. 510106 Ref. No. — hose connector for air trap

air trap accessories

	1
Part No. 510105	Ref. No. 011674
description hose connector for air trap	
spare parts for 510105	
	Part No. 510017 Ref. No. 0468007 union screw



washing and rinsing systems



1

Part No.	524406	Ref. No.	011909
description	bush for wash arm		



1

Part No.	510016	Ref. No.	011498 011675 020696
description	eye bolt for rinse aid container connection		



1

Part No.	510112	Ref. No.	011601
description	Thumb screw thread M10 thread L 10mm ø 22mm H 4.5mm SS		

for toasters

pliers

pliers



1

Part No.	690010	Ref. No.	A040894
description	plier for toaster H 180mm total length 100mm		
For models:	A151300, A151600		

knobs

producer-specific knobs

BARTSCHER



1

Part No.	112626 ¹	Ref. No.	A040082
description	knob oven t.max. °C°C ø 41mm shaft ø 6x4.6mm shaft flat lower black		
For models:	A151300, A151600		

¹with rosette 58mm

1

Part No.	112622 ¹	Ref. No.	0KG20526
description	knob thermostat 1-10 t.max. °C°C ø 41mm shaft ø 6x4.6mm shaft flat lower black		
For models:	A203093, A203094		

¹with rosette 58mm

1

Part No.	112618 ¹	Ref. No.	A040078
description	knob thermostat t.max. 190°C 50-190°C ø 41mm shaft ø 6x4.6mm shaft flat lower black		
For models:	A150107, A150207		

¹with rosette 58mm

1

Part No.	112617 ¹	Ref. No.	01044465A A039853
description	knob thermostat t.max. 300°C 50-300°C ø 41mm shaft ø 6x4.6mm shaft flat lower black		
For models:	104447, A150671, A150674		

¹with rosette 58mm

1

Part No.	112619 ¹	Ref. No.	040574
description	knob thermostat t.max. 80°C 30-80°C ø 41mm shaft ø 6x4.6mm shaft flat lower black		
For models:	103.122, 103063		

¹with rosette 58mm



1

Part No.	112620 ¹	Ref. No.	A0YXD1A4A09
description	knob thermostat t.max. 300°C 50-300°C ø 48mm shaft ø 6x4.6mm shaft flat upper black		
For models:	105780, A120788		

¹with rosette 70mm



1

Part No.	112616 ¹	Ref. No.	010578016
description	knob time 120min + ON t.max. °C ø 41mm shaft ø 6x4.6mm shaft flat lower black		
For models:	105780		

¹with rosette 58mm



1

Part No.	112621 ¹	Ref. No.	A0YXD1A4A08
description	knob time 120min t.max. °C ø 48mm shaft ø 6x4.6mm shaft flat upper black		
For models:	A120788		

¹with rosette 70mm



1

Part No.	112624 ¹	Ref. No.	A040898
description	knob time 15min t.max. °C ø 41mm shaft ø 6mm shaft flat black rosette ø 58mm		
For models:	A151300, A151600		

¹with rosette 58mm

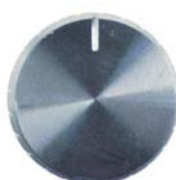

1

Part No.	112535	Ref. No.	01143562
description	knob switch zero mark t.max. °C ø 23mm shaft ø 6x4.6mm shaft flat upper silver		



1

Part No.	112625 ¹	Ref. No.	A040899
description	knob time 15min t.max. °C ø 41mm shaft ø 6x4.6mm shaft flat lower black		
For models:	A151300, A151600		

¹with rosette 58mm



1

Part No.	112537	Ref. No.	A02011006
description	knob switch zero mark t.max. °C ø 41mm shaft ø 6x4.6mm shaft flat left black		



1

Part No.	112533 ¹	Ref. No.	0AT93617 A0AT93617 EB-600-00
description	knob energy regulator t.max. °C ø 48mm shaft ø 6x4.6mm shaft flat upper black		
For models:	151510, A1515001		

¹with rosette 70mm



1

Part No.	112649 ¹	Ref. No.	016240421	
description	knob switch zero mark t.max. °C ø 50mm shaft ø 6x4.6mm shaft flat upper black			
accessories for	112649			
	Part No.	112653	Ref. No.	016240423
	slide ring ø 50mm black plastic for knob			

¹with rosette 55mm



1

Part No.	112653	Ref. No.	016240423
description	slide ring ø 50mm black plastic for knob		
accessories for	112653		
	Part No.	112649	Ref. No. 016240421
	knob switch zero mark t.max.°C ø 50mm shaft ø 6x4.6mm shaft flat upper black		

accessories

rosettes



1

Part No.	112058	Ref. No.	003Q677
description	rosette gas tap with ignition flame knob		



1

Part No.	111897	Ref. No.	065043001
description	rosette knob		



1

Part No.	112049	Ref. No.	065043002
description	rosette knob		

handles and hand wheels

cylindrical handles

fixed

1

Part No.		Ref. No.	A030012157
description	cylindrical handle for lid		

cone handles



1

Part No.	697834	Ref. No.	A040576
description	cone handle thread M6x1 ø 13mm plastic L 53mm black thread L 6mm		
For models:	A150107, A150207		

mushroom cap handles



1

Part No.	111441	Ref. No.	016240439
description	mushroom cap handle with screw thread M4 handle ø 28mm L 24mm black for lid		

handle bars

handle bars



1

Part No.	692128	Ref. No.	010578060
description	handle rod tube ø 19mm L 690mm stainless steel		
For models:	105780		
accessories for	692128		
	Part No.	694306	Ref. No. A0308983
	console for handle rod tube ø 17mm plastic mounting pos. left/right Qty 1 pcs		

1

Part No.	694307	Ref. No.	A0YXD1A34
description	handle rod tube ø 19mm thickness 1mm L 453mm SS		
For models:	A120788		



consoles



Part No.	694306	Ref. No.	A0308983
description	console for handle rod tube ø 17mm plastic mounting pos. left/right Qty 1 pcs		
For models:	105780, A120788		
accessories for	694306		
	Part No.	692128	Ref. No. 010578060
	handle rod tube ø 19mm L 690mm stainless steel		

bracket handles



Part No.	697997	Ref. No.	A0ND006
description	handle L 107mm H 20mm mounting distance 60mm for container ø 20mm W 46mm black		
For models:	A190141, A190161		



Part No.	698580	Ref. No.	A0ND001
description	pull handle L 114mm H 33mm mounting distance 106mm thread M3 W 30mm		
For models:	A190141, A190161		



Part No.	691510	Ref. No.	016210828 A040575
description	pull handle L 130mm H 44mm mounting distance 112mm		
For models:	103.122, 103063, A150107, A150207		



Part No.	698563	Ref. No.	A0ND024
description	pull handle L 144mm H 42mm mounting distance 136mm thread M3 W 32mm		



Part No.	700965	Ref. No.	A039859 EB-600-18
description	pull handle L 275mm H 60mm mounting distance 197mm thread M8x1.25		
For models:	151510, EB600		

folding grill handles

Part No.		Ref. No.	040212006
description	folding grill handle		



Part No.	693253	Ref. No.	0A40212002
description	folding grill handle		



Part No.	692149	Ref. No.	A0GH81334
description	handle L 155mm ø 30mm seat ø 10mm for contact grill		
For models:	A150671, A150674		

recessed handles



Part No.	697995	Ref. No.	016240427
description	recessed handle L 90mm W 60mm H 23.5mm mounting distance 75mm plastic for fryer		



miscellaneous



1

Part No.	691511	Ref. No.	A02011007
description	door handle L 160mm W 36mm hole distance 116mm		



1

Part No.	701455	Ref. No.	65131014
description	oven hinge mounting distance 118mm lug mounting 13mm lever length 117mm groove distance 11mm spring thickness 4mm mounting ear position right spring length 55mm L 155mm W 22mm		

hinges

oven hinges



1

Part No.	701380	Ref. No.	0A0YXD4A42
description	hinge mounting distance 142mm lever length 116mm groove distance 7mm spring thickness 3.5mm mounting ear position L 155mm W 19mm		
For models:	A120788		



1

Part No.	701404	Ref. No.	06532728
description	oven hinge mounting distance 118mm mounting distance 2mm lug mounting 14mm lever length 117mm groove distance 11mm spring thickness 4mm mounting ear position left/right spring length 55mm L 155mm mounting pos. W 22mm		



1

Part No.	701454	Ref. No.	65131015
description	oven hinge mounting distance 118mm lug mounting 13mm lever length 117mm groove distance 11mm spring thickness 4mm mounting ear position left spring length 55mm L 155mm W 22mm		



1

Part No.	701217	Ref. No.	0CER001
description	oven hinge mounting distance 142mm lever length 118mm groove distance 10mm spring thickness 3.5mm spring length 57mm L 155mm mounting pos. left/right W 21mm		

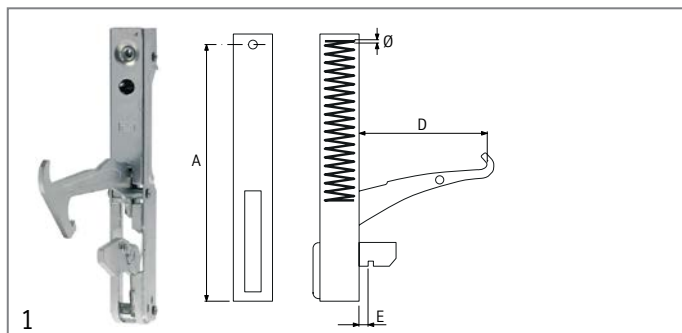

Part No.	700000	Ref. No.	01057803
description	oven hinge mounting distance 142mm mounting distance 2mm lug mountingmm lever length 127mm groove distance 10mm spring thickness 3.7mm mounting ear position L 155mm mounting pos. left/ right		
For models:	105780		
accessories for	700000		
	Part No.	693045	Ref. No. —
	opposite support L 110mm W 12mm mounting distance 94mm		
	Part No.	700707	Ref. No. —
	opposite support mounting distance 94mm L 140mm mounting pos. left W 13mm with welded metal sheet H 110mm for hinge		

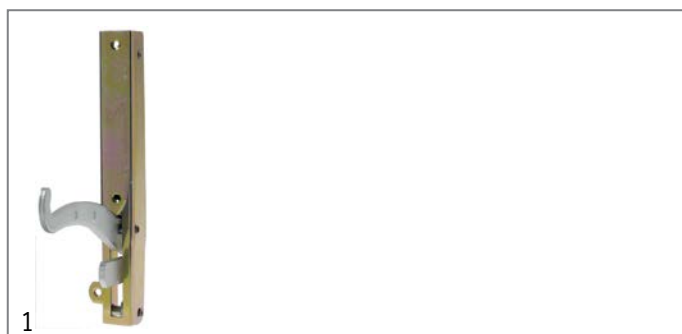

Part No.	700006	Ref. No.	022752
description	oven hinge mounting distance 173mm mounting distance 2 105mm lug mounting 14mm lever length 120mm groove distance 11mm spring thickness 3.5mm mounting ear position left spring length 112mm W 25mm		
accessories for	700006		
	Part No.	700001	Ref. No. —
	opposite support L 118mm W 17mm mounting distance 94mm		
	Part No.	700007	Ref. No. 022751
	oven hinge mounting distance 173mm mounting distance 2 105mm lug mounting 14mm lever length 120mm groove distance 11mm spring thickness 3.5mm mounting ear position right spring length 112mm W 25mm		

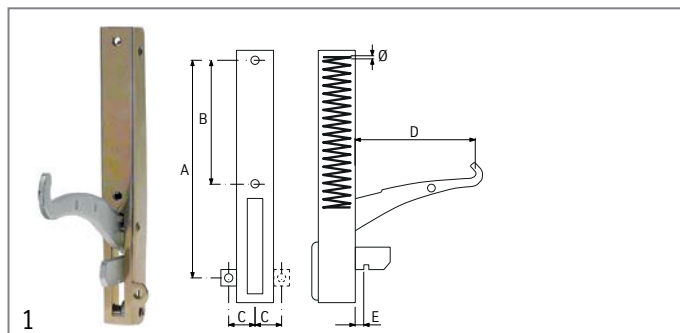

Part No.	700007	Ref. No.	022751
description	oven hinge mounting distance 173mm mounting distance 2 105mm lug mounting 14mm lever length 120mm groove distance 11mm spring thickness 3.5mm mounting ear position right spring length 112mm W 25mm		
accessories for	700007		
	Part No.	700001	Ref. No. —
	opposite support L 118mm W 17mm mounting distance 94mm		

miscellaneous

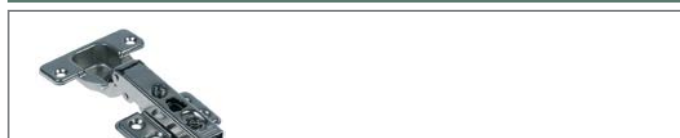

Part No.	700926	Ref. No.	040607
description	door hinge L 75mm W 60mm mounting distance 48mm		
For models:	103.122, 103063		

fittings for catering equipment

outlet taps

universal

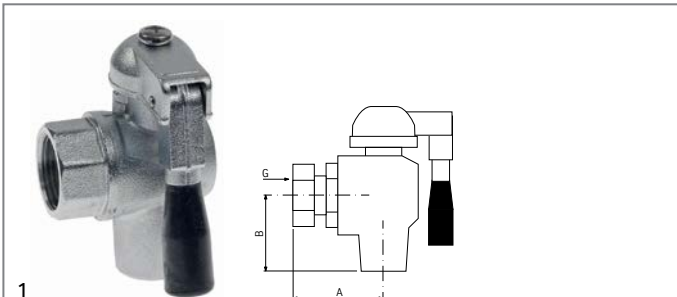

Part No.	697834	Ref. No.	A040576
description	cone handle thread M6x1 \varnothing 13mm plastic L 53mm black thread L 6mm		
For models:	A150107, A150207		

1

Part No.	541540	Ref. No.	016210829 A040578
description	outlet tap stainless steel W 38mm H 40mm thread 3/4" IT		
For models:	A150107, A150207		
spare parts for	541540		
	Part No.	697834	Ref. No. A040576
	cone handle thread M6x1 ø 13mm plastic L 53mm black thread L 6mm		



1

Part No.	692499	Ref. No.	016210831 A041308
description	reducer L 46mm thread 1/2" ET / 3/4" ET ø 26mm		
For models:	A150107, A150207		



1

Part No.	541749	Ref. No.	016210830
description	rosette for outlet tap thread D1 ø 63mm D2 ø 25mm		
For models:	A150207		

dispenser tap

complete



1

Part No.	527165	Ref. No.	A040375
description	outlet tap complete ø 40mm inlet 3/8" plastic black		

equipment feet and end caps

equipment feet

with screw mounting



Part No.	513287	Ref. No.	0926117
description	equipment foot tube ø 60mm thread M12 thread L 33mm H 155-235mm SS size 2" Qty 1 pcs		

screw-in feet



Part No.	693204	Ref. No.	047122001
description	equipment foot hot bar		



Part No.	700966	Ref. No.	A038973
description	equipment foot thread L 20mm ø 37mm H 20mm Qty 1 pcs		
For models:	105780, A120788		

1

Part No.		Ref. No.	030012167
description	equipment foot thread M10 saladette		

1

Part No.		Ref. No.	031136
description	equipment foot thread M8 BETA I/II		



bolting feet

 <p>1</p>			
Part No.	697849	Ref. No.	01044461
description	equipment foot H 28mm thread M8 D1 ø 50mm D2 ø 38mm thread L 10mm		
For models:	104447		

 <p>1</p>			
Part No.	697996	Ref. No.	016240431
description	equipment foot ø 23mm H 23.5mm bore ø 5mm Qty 1 pcs		

 <p>1</p>			
Part No.	697998	Ref. No.	01058356
description	equipment foot ø 24/36mm H 25mm bore ø 19mm Qty 1 pcs thread M8x1.25		

 <p>1</p>			
Part No.	691509	Ref. No.	0AT93602 A042567 A0AT93602 EB-600-04
description	equipment foot ø 28mm H 17.5mm rubber bore ø 6mm Qty 1 pcs		
For models:	151510, A114001, A150107, A150207, A150671, A150674, A151300, A1515001, A151600, A203093, A203094, EB600		

baskets

fryer baskets

BARTSCHER

 <p>1</p>			
Part No.	970741	Ref. No.	016240416 165513 165519 165522
description	fryer basket W1 140mm L1 210mm H1 125mm chrome-plated steel		

 <p>1</p>			
Part No.	970811	Ref. No.	165514 165520 165523
description	fryer basket W1 190mm L1 240mm H1 145mm L2 445mm H2 170mm H3 280mm chrome-plated steel plastic		

 <p>1</p>			
Part No.	970716	Ref. No.	016210815 165516 A040571
description	fryer basket W1 192mm L1 230mm H1 140mm L2 470mm H2 200mm H3 220mm		
For models:	A150107, A150207		

 <p>1</p>			
Part No.	970825	Ref. No.	165518
description	fryer basket W1 192mm L1 230mm H1 142mm L2 460mm H2 195mm H3 230mm stainless steel		

 <p>1</p>			
Part No.	697833	Ref. No.	A041303
description	handle for fryer basket L 142mm H 21mm W 39mm		
For models:	A150107, A150207		

crumb screens

 <p>1</p>			
Part No.	970743	Ref. No.	016210816 A041310
description	crumb screen L 245mm W 205mm H 5mm chrome-plated steel for fryer		
For models:	A150107, A150207		

1

Part No.	970742	Ref. No.	016240418
description	crumb screen L 216mm W 149mm H 37mm chrome-plated steel for fryer		

miscellaneous

1

Part No.		Ref. No.	A030048022V
description	basket without bottom		

shelves and shelf rails

grates

producer-specific

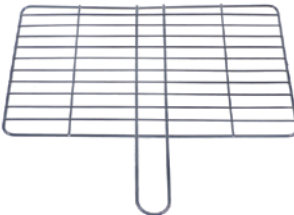

1

Part No.	970715	Ref. No.	A040581
description	chargrill grid W 223mm D 352mm H 9mm chrome-plated steel with handle for toaster wire gauge frame 4mm lengthwise wires gauge 2.5mm crossing wires 4 BARTSCHER		
For models:	A151300, A151600		

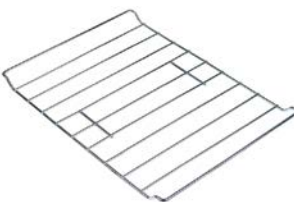

1

Part No.	210198	Ref. No.	A030048044
description	chargrill grid W 245mm D 346mm chrome-plated steel		



1

Part No.	210200	Ref. No.	030048019
description	chargrill grid W 250mm D 315mm		



1

Part No.	210201	Ref. No.	030048021
description	chargrill grid W 250mm D 315mm		



1

Part No.	210260	Ref. No.	OAT93606 A0AT93606
description	chargrill grid W 250mm D 450mm chrome-plated steel with handle suitable for salamander grill		
For models:	A1515001		

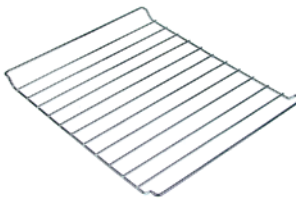

1

Part No.	210197	Ref. No.	A030048042
description	chargrill grid W 290mm D 357mm chrome-plated steel		

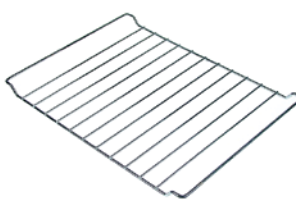

1

Part No.	210199	Ref. No.	A030048043
description	chargrill grid W 290mm D 397mm chrome-plated steel		

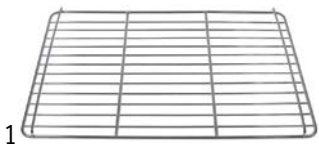
1

Part No.	970813	Ref. No.	786002 786005
description	chargrill grid W 315mm D 435mm H 15mm chrome-plated steel L 315mm crossing wires 2		

gaskets

refrigeration gaskets

plug-in gaskets

profile 9399

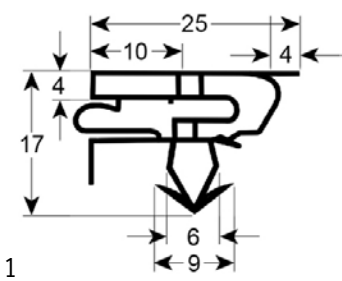

1

Part No.	902156	Ref. No.	0700075
description	refrigeration gasket profile 9399 W 415mm L 430mm plug size		

screw-in gaskets

profile 9031

We offer custom-made gaskets for this profile

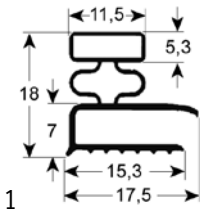

1

Part No.	900266	Ref. No.	030012200
description	refrigeration gasket profile 9031 W 440mm L 600mm external size		

profile 9970

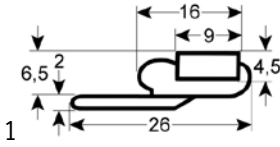

1

Part No.	902470	Ref. No.	038275
description	refrigeration gasket profile 9970 W 420mm L 505mm external size		
For models:	700158G-McDonalds		

gaskets for heated units

door seals with fixing hook



1

Part No.	901178	Ref. No.	010578049
description	door seal L 330mm W 680mm with 12 holes type series until 03/2013		
For models:	105780		



1

Part No.	901946	Ref. No.	012078919
description	door seal W 320mm with 8 mounting clips H 260mm		



1

Part No.	900264	Ref. No.	A030044013
description	door seal W 360mm with mounting clip H 225mm		



1

Part No.	900265	Ref. No.	030044015
description	door seal W 405mm long side open with mounting clip H 245mm		

1

Part No.	901842	Ref. No.	0105780491
description	door seal W 680mm H 330mm type series since 03/2013 16 holes		

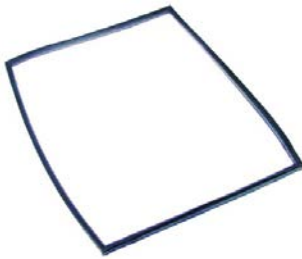

1

Part No.	900393	Ref. No.	030004007
description	oven gasket L 330mm W 420mm external size		



1

Part No.	901354	Ref. No.	A038980
description	oven gasket L 430mm W 330mm with 8 mounting clips		
For models:	A120788		

O-rings

EPDM

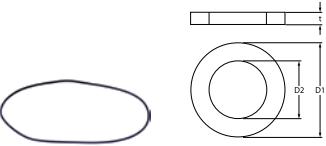

1

Part No.	521717	Ref. No.	019380 021858
description	O-ring EPDM thickness 1.78mm ID ø 120.37mm Qty 1 pcs		

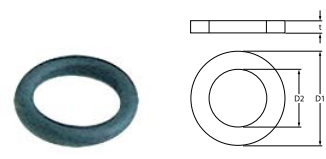

1

Part No.	529412	Ref. No.	011499 011676 011677 0456048
description	O-ring EPDM thickness 2.62mm ID ø 10.78mm Qty 1 pcs		

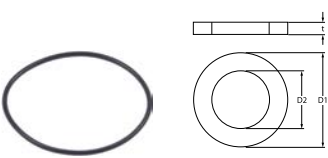

1

Part No.	532618	Ref. No.	016240424
description	O-ring EPDM thickness 2mm ID ø 48.5mm Qty 1 pcs		

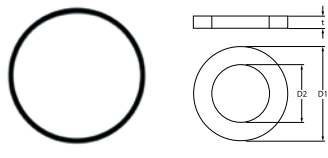

1

Part No.	510009	Ref. No.	011691
description	O-ring EPDM thickness 3.53mm ID ø 101.2mm Qty 1 pcs		

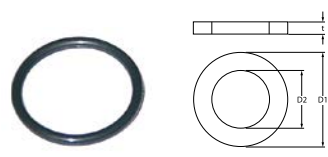

1

Part No.	510072	Ref. No.	011630 012249 0456016
description	O-ring EPDM thickness 3.53mm ID ø 32.93mm Qty 1 pcs		

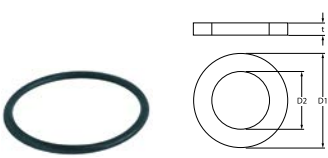

1

Part No.	532118	Ref. No.	021145 214289
description	O-ring EPDM thickness 3.53mm ID ø 55.56mm Qty 10 pcs		



1

Part No.	532498	Ref. No.	0456047
description	O-ring EPDM thickness 3.53mm ID ø 9.12mm Qty 1 pcs		

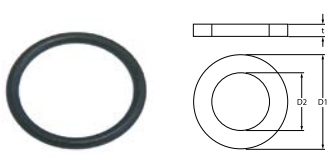

1

Part No.	510408	Ref. No.	011510 011620
description	O-ring EPDM thickness 5.34mm ID ø 47mm Qty 1 pcs		

1

Part No.	510409	Ref. No.	0929046
description	O-ring EPDM thickness 5.34mm ID ø 56.52mm Qty 1 pcs		

Viton

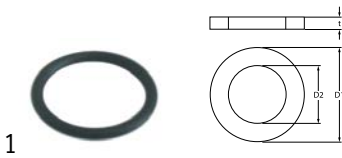

1

Part No.	532504	Ref. No.	030010104
description	O-ring Viton thickness 2.62mm ID ø 20.24mm Qty 1 pcs		



1

Part No.	550496	Ref. No.	049671
description	O-ring Viton thickness 3.53mm ID ø 50.39mm Qty 1 pcs		

sealing washers

fibre gaskets



1

Part No.	529160	Ref. No.	004652632
description	flat gasket fibre ED ø 32mm ID ø 26mm thickness 1.5mm for drain tap suitable for 541540 Qty 1 pcs		
For models:	A150107, A150207		



1

Part No.	510405	Ref. No.	012291
description	flat gasket fibre ED ø 56mm ID ø 42mm thickness 2mm for thread 1¼" Qty 1 pcs		

rubber gaskets



1

Part No.	513059	Ref. No.	0437063
description	flat gasket rubber ED ø 52mm ID ø 40mm thickness 3mm Qty 1 pcs		



1

Part No.	521124	Ref. No.	0481946669609
description	flat gasket rubber ED ø 52mm ID ø 42mm thickness 6mm Qty 1 pcs		



1

Part No.	518060	Ref. No.	0456040
description	gasket rubber ED ø 132mm ID ø 122mm thickness 5mm		

PTFE gaskets



1

Part No.	510012	Ref. No.	011662
description	flat gasket PTFE ED ø 16.5mm ID ø 12.5mm thickness 1.5mm Qty 1 pcs equiv. no. 437008		

silicone gaskets



1

Part No.	504296	Ref. No.	A040382
description	flat gasket silicone ED ø 29mm ID ø 12mm thickness 1.6mm Qty 1 pcs for coffee machine		
For models:	A190141, A190161		



1

Part No.	511646	Ref. No.	AOND011
description	gasket silicone ED ø 63mm ID ø 55mm thickness 2.3mm Qty 1 pcs for heating element		
For models:	A190141, A190161		

special gaskets

miscellaneous



1

Part No.	504297	Ref. No.	AOND036
description	gasket for water level tube ED ø 13mm ID ø 6mm silicone		
For models:	A190141, A190161		



thermostat gaskets



1

Part No.	512205	Ref. No.	016240433
description	gasket for temperature probe ED ø 15mm plastic Qty 1 pcs		

transmission technology and ball bearings

chains

roller chains 04B-1 single



1

Part No.	697844	Ref. No.	A039870
description	chain DIN/ISO 04 B-1 splitting 6mm links 58 L 365mm internal width 2.8mm rollerø 4mm single		
For models:	151510		

springs

torsion springs



1

Part No.	700569	Ref. No.	A0GH81313
description	torsion spring ø 21.5mm L2 40mm wire gauge ø 3.3mm L1 100mm L3 45mm		
For models:	A150671, A150674		

compression springs



1

Part No.	112063	Ref. No.	0011564
description	knob spring ø 24mm L 28mm wire gauge ø 0.9mm		

tension springs



1

Part No.	693175	Ref. No.	030014013
description	tension spring total length 330mm		

kitchen accessories

gastronorm

bridges

1

Part No.		Ref. No.	047233076
description	bridge for Gastronorm container		

1

Part No.		Ref. No.	047233173
description	bridge for Gastronorm container		

baking sheets

1

Part No.		Ref. No.	031165
description	baking sheet suitable for BETA I/II		

1

Part No.	694532	Ref. No.	100 403 100.303
description	baking sheet W 325mm L 530mm perforated		









dosing pumps

piston pumps

with solenoid coil



1

Part No.	361013	Ref. No.	010799
description	dosing pump inlet 4x6mm outlet 5mm 230V rinse aid duty cycle 25% type EKP-M 50Hz impulse 3imp/s		
spare parts for	361013		
	Part No.	361482	Ref. No. —
	solenoid coil 230VAC for type EKP-M		
	Part No.	361811	Ref. No. —
	hose connector for dosing pump hose ø 6.3mm T1: M12x1.5 chrome-plated brass		
	Part No.	371090	Ref. No. —
	power socket plug type DIN 43650A screw		
accessories for	361013		
	Part No.	361366	Ref. No. —
	PCB dishwasher 11F suitable for DB2 type DB2/EV1/EKP-M		
	Part No.	361505	Ref. No. —
	screw pipe fitting straight nickel-plated brass thread 3/8" IT hose ø 6x8mm		

spare parts



1

Part No.	361113	Ref. No.	011525 011639
description	solenoid coil 230VAC for type DB2		











membrane dosing pumps

self-priming

SEKO



1

Part No.	361364 ¹	Ref. No.	0209025
description	dosing pump type DIB5E self-sucking rinse aid pump rate 0-5cm ³ per stroke pressure connection ø 4x6mm suction connection ø 4x6mm SEKO supporting pressure closed		
spare parts for	361364		
	Part No.	361301	Ref. No. —
	hose connector for type DIB3E/DIB5E		
	Part No.	361302	Ref. No. —
	valve bush for type DIB3E/DIB5E		
	Part No.	361304	Ref. No. —
	O-ring EPDM ID ø 11.11mm thickness 1.78mm Qty 1 pcs for type DIB3E/DIB5E		
	Part No.	361305	Ref. No. —
	valve disc for type DIB3E/DIB5E DIB3P/DIB5P		
	Part No.	361306	Ref. No. —
	membrane for type DIB3E/DIB5E ø 49mm hole ø 5mm		
	Part No.	361307	Ref. No. —
	membrane dosing pump ø 68mm hole ø 6mm for type DIB3P/DIB5P		
	Part No.	361459	Ref. No. —
	hose connector ø 6mm for dosing pump		
	Part No.	361481	Ref. No. —
	lip valve for type DIB3P/DIB5P DIB3E/DIB5E		
accessories for	361364		
	Part No.	361240	Ref. No. —
	hose connector 1-way hose ø 6mm plastic connection M10x1		
	Part No.	361241	Ref. No. —
	hose connector 1-way hose ø 9mm plastic connection M10x1		

¹auxiliary pressure connection closed



hoses

drain hoses



1

Part No.	518068	Ref. No.	020453
description	drain hose DN34 L 2000mm elbow ø inside 50mm elbow ext. ø 59mm inner hose ø 35mm outer hose ø 42mm PVC		

industrial hoses

Niplaflex hoses



1

Part No.	570561	Ref. No.	011637
description	pressure hose ID ø 10mm ED ø 17mm L 40m thickness 3.5mm operating p. 10bar burst p. 30bar t.max. 110°C		



1

Part No.	530561	Ref. No.	011503
description	pressure hose ID ø 10mm ED ø 17mm L 5m thickness 3.5mm operating p. 10bar burst p. 30bar t.max. 110°C		

ancillary products

clamps

hose clamps

DIN 3017 - W2



1

Part No.	520110	Ref. No.	0423010 neu 21.05.96
description	hose clamp ø 8-12mm width 9mm Qty 10 pcs DIN 3017		

measuring equipment

thermometers

thermometers with core sensor



1

Part No.	541096	Ref. No.	A293043
description	penetration thermometer L 139mm -50 up to +300°C display digital ø 35mm NTC probe L 120mm		



1

Part No.	541097	Ref. No.	A292044
description	penetration thermometer L 143mm -10 up to 100°C t.max. 100°C display analogue ø 27mm probe L 120mm		

miscellaneous



1

Part No.	541093	Ref. No.	A292048
description	thermometer -30 up to +30°C size ø60mm display analogue		

1

Part No.	541098	Ref. No.	A292049
description	thermometer -30 up to +50°C size ø52mm display analogue		



1

Part No.	541094	Ref. No.	A292043
description	thermometer -40 up to +25°C size 124x30mm display analogue		

fastening material

screws

knurled screws



1

Part No.	510112	Ref. No.	011601
description	Thumb screw thread M10 thread L 10mm ø 22mm H 4.5mm SS		

nuts

hexagonal nuts

hexagonal nuts inch thread



1

Part No.	501318	Ref. No.	152-2
description	nut thread 1/4" H 6.5mm SS WS 22 Qty 1 pcs		

fasteners

clamps

hose clamps

DIN 3017 - W2



1

Part No.	520110	Ref. No.	0423010 neu 21.05.96
description	hose clamp ø 8-12mm width 9mm Qty 10 pcs DIN 3017		

roll pins



1

Part No.	692236	Ref. No.	A0GH81316
description	roll pin ø 4mm L 40mm		
For models:	A150671, A150674		

consumables

coffee filters

basket filters

paper filters



1

Part No.	960100	Ref. No.	190013
description	paper filter for coffee makers D1 ø 90mm D2 ø 250mm Qty 1000 pcs		

fuses

fine fuses



1

Part No.	358533	Ref. No.	01143561
description	fine fuse size ø5x20mm 6.3A fast-acting rated 250V Qty 10 pcs		

GASTROPARTS.COM

