



GASTROPARTS

Azkoyen

[EN] Equipment

[DE] Geräte

[ES] Aparatos

[FR] Équipement

[IT] Attrezzature

[PL] Urządzenia

[RU] Оборудование

✉ gastroparts@gastroparts.com

☎ +48 56 657 00 66

📘 fb.com/gastroparts.global



GASTROPARTS.COM





heating elements

heating elements for coffee machine

 <p>1</p>			
Part No.	417092	Ref. No.	N/A
description	heating element 3000W 230V heating circuits 2 mounting \varnothing 40mm hole distance 52mm L 358mm W 41mm H 50mm L1 25mm L2 43mm L3 287mm H1 26mm H2 24mm windings 2 hole \varnothing 9mm tube \varnothing 8.5mm connection M4 immersion heater 3 hole flange suitable for AZKOYEN		
accessories for	417092		
 <p>Part No. 528340 Ref. No. N/A</p> <p>gasket ID \varnothing 40.5mm fibre thickness 3mm hole \varnothing 10mm hole distance 52mm for heating element coffee machine parts</p>			

 <p>1</p>			
Part No.	417093	Ref. No.	N/A
description	heating element 4000W 230V heating circuits 2 mounting \varnothing 40mm hole distance 52mm L 468mm W 39mm H 52mm L1 22mm L2 41mm L3 405mm H1 26mm windings 2 hole \varnothing 9mm connection M4 immersion heater compression flange suitable for AZKOYEN		

accessories



flange gaskets

 <p>1</p>			
Part No.	528340	Ref. No.	N/A
description	gasket ID \varnothing 40.5mm fibre thickness 3mm hole \varnothing 10mm hole distance 52mm for heating element coffee machine parts		

switches and momentary switches

rocker/momentary rocker switches

25.5x25mm

 <p>1</p>			
Part No.	345013 ¹	Ref. No.	N/A
description	rocker switch mounting measurements 25.5x25mm red 2NO 250V 16A illuminated 0-I connection male faston 6.3mm		
accessories for	345013		
 <p>Part No. 301323 Ref. No. —</p> <p>protective cover external size 35x35mm H 11mm transparent suitable for rocker switch mounting measurements 25.5x25mm L 35mm W 35mm</p>			

¹illuminated

lamps

indicator lights

indicator lights (complete)

\varnothing 6mm

 <p>1</p>			
Part No.	359419	Ref. No.	N/A
description	indicator light \varnothing 6mm 230V green cable length 200mm		

 <p>1</p>			
Part No.	359420	Ref. No.	N/A
description	indicator light \varnothing 6mm 6V green cable length 250mm		

\varnothing 10mm

with plug-in socket



 <p>1</p>			
Part No.	359418	Ref. No.	N/A
description	indicator light \varnothing 10mm yellow 230V connection male faston 6.3mm Qty 1 pcs		

relays

power relays

with male contacts

female contact 4.8mm

 <p>1</p>			
Part No.	380475	Ref. No.	N/A
description	power relays FINDER 220-240VAC 12A 2CO connection F4.8 raster size 10mm plug-in connection manuf. no. 56.32.8.230.0040 250V 2-pole connection 4.8mm		
accessories for	380475		
 <p>Part No. 380476 Ref. No. —</p> <p>relay socket dimensions 78x27x33.5mm 250V voltage AC 10A FINDER manuf. no. 96.72</p>			



solenoid valves

solenoid valves (water)

metal

ASCO

spare parts and accessories

O-rings



1

Part No.	371100	Ref. No.	N/A
description	O-ring silicone thickness 1.78mm ID ø 6.07mm Qty 1 pcs		





LUCIFER

3-way

131F series







1

Part No.	370053	Ref. No.	N/A
description	solenoid valve 3-ways 230VAC DN 2.5mm slide-on receptacle DIN -10 up to 140°C type series 131F coil type DZ06S6 membranes FKM (water/steam) p max 10bar flange 32x32mm		
spare parts for	370053		
	Part No.	370061	Ref. No. N/A
	solenoid valve body LUCIFER-PARKER 3-ways outer cone		
	Part No.	371031	Ref. No. N/A
	solenoid coil LUCIFER-PARKER 230VAC 9VA coil type DZ06S6 seat ø 15mm		
accessories for	370053		
	Part No.	371090	Ref. No. N/A
	power socket plug type DIN 43650A screw		
	Part No.	371095	Ref. No. —
	O-ring Viton thickness 1.78mm ID ø 6.07mm Qty 1 pcs		
	Part No.	371100	Ref. No. N/A
	O-ring silicone thickness 1.78mm ID ø 6.07mm Qty 1 pcs		



1

Part No.	370054	Ref. No.	N/A
description	solenoid valve 3-ways 24VAC DN 2.5mm slide-on receptacle DIN -10 up to 140°C type series 131F coil type DZ06P0 membranes FKM (water/steam) p max 10bar flange 32x32mm		
spare parts for	370054		
	Part No.	370061	Ref. No. N/A
	solenoid valve body LUCIFER-PARKER 3-ways outer cone		
	Part No.	371032	Ref. No. N/A
	solenoid coil LUCIFER-PARKER 24VAC 9VA 50/60Hz coil type DZ06P0 seat ø 15mm		
accessories for	370054		
	Part No.	371090	Ref. No. N/A
	power socket plug type DIN 43650A screw		
	Part No.	371095	Ref. No. —
	O-ring Viton thickness 1.78mm ID ø 6.07mm Qty 1 pcs		
	Part No.	371100	Ref. No. N/A
	O-ring silicone thickness 1.78mm ID ø 6.07mm Qty 1 pcs		

spare parts and accessories

solenoid coils



1

Part No.	371031	Ref. No.	N/A
description	solenoid coil LUCIFER-PARKER 230VAC 9VA coil type DZ06S6 seat ø 15mm		





1

Part No.	371032	Ref. No.	N/A
description	solenoid coil LUCIFER-PARKER 24VAC 9VA 50/60Hz coil type DZ06P0 seat ø 15mm		





valve bodies			
			
1			
Part No.	370061	Ref. No.	N/A
description	solenoid valve body LUCIFER-PARKER 3-ways outer cone		

ODE			
solenoid valves steam (water)			
31A1 series			
			
1			
Part No.	370203	Ref. No.	N/A
description	solenoid valve brass 3-ways 230VAC DN 2.5mm -10 up to 140°C ODE type series 31A1 coil type BDV membranes FKM (water/steam) p max 6bar p min 0.1bar outer cone flange 32x32mm		
spare parts for	370203		
	Part No.	371150	Ref. No.
			N/A
description	solenoid coil ODE 230VAC 16VA coil type BDV seat ø 13.5mm 7500hm		
accessories for	370203		
	Part No.	371090	Ref. No.
			N/A
description	power socket plug type DIN 43650A screw		

spare parts and accessories			
solenoid coils			
			
1			
Part No.	371150	Ref. No.	N/A
description	solenoid coil ODE 230VAC 16VA coil type BDV seat ø 13.5mm 7500hm		

PARKER			
2-way			
E-146 series			
			
1			
Part No.	370067	Ref. No.	N/A
description	solenoid valve 2-ways 230VAC connection 1/4" L 40mm DN 3mm slide-on receptacle DIN -20° up to 130°C PARKER type series VE-146 coil type ZB09 membranes FKM (water) p max 7bar		
spare parts for	370067		
	Part No.	371029	Ref. No.
			N/A
description	solenoid coil PARKER 230VAC 9VA coil type ZB09 seat ø 14mm H 33mm W 34mm D 43mm		
accessories for	370067		
	Part No.	371090	Ref. No.
			N/A
description	power socket plug type DIN 43650A screw		

			
1			
Part No.	370034	Ref. No.	N/A
description	solenoid valve 2-ways 24VAC connection 1/4" DN 3mm slide-on receptacle DIN -20° up to 130°C PARKER type series VE-146 coil type ZB09 membranes FKM (water) p max 10bar		
spare parts for	370034		
	Part No.	371036	Ref. No.
			N/A
description	solenoid coil 24VAC 9VA coil type ZB09 seat ø 14mm		
accessories for	370034		
	Part No.	371090	Ref. No.
			N/A
description	power socket plug type DIN 43650A screw		







3-way			
VE-128 series			
			
1			
Part No.	370057	Ref. No.	N/A
description	solenoid valve 3-ways 230VAC body outer cone DN 1.2mm slide-on receptacle DIN -20° up to 140°C PARKER type series VE-128 coil type ZB09 membranes ruby p max 10bar brass flange 32x32mm		
spare parts for	370057		
	Part No.	370062	Ref. No.
			N/A
description	solenoid valve body PARKER 3-ways outer cone		

Table continues overleaf



spare parts for 370057				
	Part No.	371029	Ref. No.	N/A
solenoid coil PARKER 230VAC 9VA coil type ZB09 seat ø 14mm H 33mm W 34mm D 43mm				
accessories for 370057				
	Part No.	371090	Ref. No.	N/A
power socket plug type DIN 43650A screw				
	Part No.	371095	Ref. No.	—
O-ring Viton thickness 1.78mm ID ø 6.07mm Qty 1 pcs				
	Part No.	371100	Ref. No.	N/A
O-ring silicone thickness 1.78mm ID ø 6.07mm Qty 1 pcs				

spare parts and accessories

solenoid coils



1

Part No.	371036	Ref. No.	N/A
description	solenoid coil 24VAC 9VA coil type ZB09 seat ø 14mm		







1



Part No.	371029	Ref. No.	N/A	
description	solenoid coil PARKER 230VAC 9VA coil type ZB09 seat ø 14mm H 33mm W 34mm D 43mm			
accessories for 371029				
	Part No.	371090	Ref. No.	N/A
power socket plug type DIN 43650A screw				

valve bodies



1

Part No.	370062	Ref. No.	N/A	
description	solenoid valve body PARKER 3-ways outer cone			
accessories for 370062				
	Part No.	371029	Ref. No.	N/A
solenoid coil PARKER 230VAC 9VA coil type ZB09 seat ø 14mm H 33mm W 34mm D 43mm				
	Part No.	371030	Ref. No.	—
solenoid coil 24VDC 12VA coil type ZB12 seat ø 14mm				
	Part No.	371033	Ref. No.	—
solenoid coil PARKER 230VAC 9VA coil type YB09 with cable seat ø 14mm				
	Part No.	371036	Ref. No.	N/A
solenoid coil 24VAC 9VA coil type ZB09 seat ø 14mm				

accessories for 370062				
	Part No.	371095	Ref. No.	—
O-ring Viton thickness 1.78mm ID ø 6.07mm Qty 1 pcs				
	Part No.	371100	Ref. No.	N/A
O-ring silicone thickness 1.78mm ID ø 6.07mm Qty 1 pcs				

solenoid valves (refrigeration)

CASTEL

spare parts and accessories



1

Part No.	371090	Ref. No.	N/A
description	power socket plug type DIN 43650A screw		

Solenoid valve - accessories



1

Part No.	371100	Ref. No.	N/A
description	O-ring silicone thickness 1.78mm ID ø 6.07mm Qty 1 pcs		



pressure switches

for coffee machines

miscellaneous



1

Part No.	541021	Ref. No.	N/A	
description	pressure control pressure range adjustable 0.5-1.4bar connection 1/4" 30A 3-pole type P302 coffee machine parts SIRAI			
accessories for 541021				
	Part No.	550262	Ref. No.	—
flat gasket copper ED ø 20mm ID ø 14mm thickness 2mm				
	Part No.	890100	Ref. No.	—
PTFE tape reel L 12m W 12mm -200 up to +260°C approval DINDVGW, KTW temperature-resistant, elastic for fine thread thickness 0.1mm				



flow meters and flow sensors

flow meters

GICAR



1

Part No.	400004	Ref. No.	N/A
description	flow meter thread 1/4" stainless steel with LED plug connection approval NSF		
accessories for	400004		
	Part No.	400256	Ref. No. N/A
	plug GICAR for flow meter		

accessories



1

Part No.	400257	Ref. No.	N/A
description	impellor GICAR H 15mm D1 ø 26.7mm D2 ø 9.8mm for flow meter		



1

Part No.	400258	Ref. No.	N/A
description	O-ring for flow meter		



1

Part No.	400256	Ref. No.	N/A
description	plug GICAR for flow meter		

pumps

booster pumps II

pump heads

FLUID-O-TECH



1

Part No.	500177	Ref. No.	N/A
description	pump head PA204X FLUID-O-TECH L 82mm 200l/h connection 3/8" GAS with filter an bypass brass clip connection for coffee machine shaft ø 4.8x11mm		

equipment-specific units

for espresso machines

filter holders

filter holders standard

filter holder without spout



1

Part No.	529158	Ref. No.	N/A
description	filter holder suitable for AZKOYEN without outlet mounting ø 83mm outlet 3/8" ID ø 62.2mm wedge hight 9.5mm wedge position horizontal number of wedges 2 lever straight		



handles

with bore



1

Part No.	529159	Ref. No.	N/A
-----------------	--------	-----------------	-----

description	handle ø 31mm aperture 10x10mm L 135mm black
--------------------	--

spouts

with thread 3/8"



1

Part No.	529003	Ref. No.	N/A
-----------------	--------	-----------------	-----

description	filter holder spout thread 3/8" 1-way curved/long outlet distance thread L 5mm
--------------------	---



1

Part No.	529001	Ref. No.	N/A
-----------------	--------	-----------------	-----

description	filter holder spout thread 3/8" 1-way straight/long outlet distance
--------------------	--



1

Part No.	529007	Ref. No.	N/A
-----------------	--------	-----------------	-----

description	filter holder spout thread 3/8" 2-way curved/short outlet distance 45mm
--------------------	--

filters

for 1 cup



1

Part No.	529012	Ref. No.	N/A
-----------------	--------	-----------------	-----

description	coffee filter ø 70mm mounting ø 60.8mm H 19.5mm cups 1 amount of coffee 6g
--------------------	---



1

Part No.	529011	Ref. No.	N/A
-----------------	--------	-----------------	-----

description	coffee filter ø 70mm mounting ø 60mm H 24.5mm cups 1 amount of coffee 7g perforation ø 0.4mm
--------------------	---

for 2 cups



1

Part No.	529013	Ref. No.	N/A
-----------------	--------	-----------------	-----

description	coffee filter ø 70mm mounting ø 60.5mm H 25.5mm cups 2 amount of coffee 14g perforation ø 0.3x0.3mm square
--------------------	---



1

Part No.	529014	Ref. No.	N/A
-----------------	--------	-----------------	-----

description	coffee filter ø 70mm mounting ø 60mm H 21mm cups 2 amount of coffee 12g perforation ø 0.3mm round
--------------------	--

blind filters



1

Part No.	529023	Ref. No.	N/A
-----------------	--------	-----------------	-----

description	blind filter ø 70mm mounting ø 60mm H 18mm
--------------------	--

filter holder springs



1

Part No.	529079	Ref. No.	N/A
-----------------	--------	-----------------	-----

description	filter holder spring L 70mm W 60mm wire gauge ø 1.3mm for espresso filter holder
--------------------	---

brewing units

shower screens

with upstand



1

Part No.	529080	Ref. No.	N/A
-----------------	--------	-----------------	-----

description	shower screen ø 58mm H 20mm
--------------------	-----------------------------





filter holder gaskets			
flat			
standard			
			
1			
Part No.	528030	Ref. No.	N/A
description	filter holder gasket D1 ø 72.7mm D2 ø 57.2mm H 8mm Qty 1 pcs		

			
1			
Part No.	528072	Ref. No.	N/A
description	filter holder gasket D1 ø 73mm D2 ø 57.5mm H 8mm		

			
1			
Part No.	528032	Ref. No.	N/A
description	filter holder gasket D1 ø 73mm D2 ø 57mm H 9mm Qty 1 pcs		

components			
screw connections			
			
1			
Part No.	528356	Ref. No.	N/A
description	screw cap		

water dispersions			
water dispersions			
group 3			
			
1			
Part No.	529157	Ref. No.	N/A
description	water distributor ø 30mm H 4.5mm 6 holes hole ø 2mm mounting ø 6.5mm brass		

boilers			
gaskets			
unperforated			
			
1			
Part No.	528341	Ref. No.	N/A
description	boiler gasket D1 ø 98mm D2 ø 92mm thickness 3mm Viton suitable for AZKOYEN		

steam/water taps			
steam/water taps			
steam/water taps			
			
1			
Part No.	529516	Ref. No.	N/A
description	steam/water tap		

components			
gaskets			
			
1			
Part No.	528349	Ref. No.	N/A
description	sealing ring		

gasket supports			
			
1			
Part No.	528351	Ref. No.	N/A
description	gasket support		



steam/water pipes

steam pipes



1

Part No.	529517	Ref. No.	N/A
-----------------	--------	-----------------	-----

description	steam pipe
--------------------	------------

water pipes



1

Part No.	529519	Ref. No.	N/A
-----------------	--------	-----------------	-----

description	water pipe short
--------------------	------------------

accessories

bushes



1

Part No.	528354	Ref. No.	N/A
-----------------	--------	-----------------	-----

description	bush PTFE
--------------------	-----------

fine filters

fine filters



1

Part No.	528357	Ref. No.	N/A
-----------------	--------	-----------------	-----

description	fine filter \varnothing 8.5mm H 22mm
--------------------	--

intake valves

intake valves



1

Part No.	529515	Ref. No.	N/A
-----------------	--------	-----------------	-----

description	intake valve water complete
--------------------	-----------------------------

accessories

gaskets



1

Part No.	528346	Ref. No.	N/A
-----------------	--------	-----------------	-----

description	gasket
--------------------	--------

level glasses

level glasses

balls



1

Part No.	529355	Ref. No.	N/A
-----------------	--------	-----------------	-----

description	ball \varnothing 6mm plastic for level glass
--------------------	--

level glass pipes



1

Part No.	528343	Ref. No.	N/A
-----------------	--------	-----------------	-----

description	water level tube \varnothing 13mm H 138mm
--------------------	---

non-return valves

complete



1

Part No.	529301	Ref. No.	N/A
-----------------	--------	-----------------	-----

description	non-return valve complete T1: 3/8"
--------------------	------------------------------------



1

Part No.	528345	Ref. No.	N/A
-----------------	--------	-----------------	-----

description	non-return valve suitable for AZKOYEN
--------------------	---------------------------------------



gaskets

O-rings

silicone

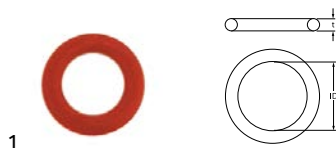

Part No.	371100	Ref. No.	N/A
description	O-ring silicone thickness 1.78mm ID ø 6.07mm Qty 1 pcs		



Part No.	528344	Ref. No.	N/A
description	O-ring silicone thickness 2.62mm ID ø 12.37mm Qty 1 pcs		

Viton

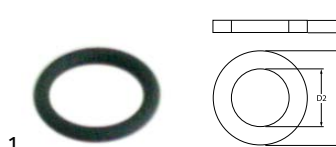

Part No.	528353	Ref. No.	N/A
description	O-ring Viton thickness 2mm ID ø 10mm Qty 1 pcs		

sealing washers

fibre gaskets



Part No.	528358	Ref. No.	N/A
description	flat gasket FIBER ED ø 24mm ID ø 18mm thickness 2.5mm Qty 1 pcs		

PTFE gaskets



Part No.	528314	Ref. No.	N/A
description	flat gasket PTFE ED ø 20mm ID ø 17mm thickness 2mm Qty 1 pcs suitable for Astoria/Azkoyen/Espresso/Wega		

special gaskets

group gaskets



Part No.	528355	Ref. No.	N/A
description	group gasket L 74mm W 74mm thickness 3.5mm suitable for AZKOYEN		

springs

compression springs



Part No.	528352	Ref. No.	N/A
description	compression spring ø 11.2mm L 27mm wire gauge ø 1.8mm		



Part No.	528348	Ref. No.	N/A
description	compression spring ø 9.5mm L 15mm wire gauge ø 1.4mm		

manometers



Part No.	541258	Ref. No.	N/A
description	manometer ø 41mm pressure range 0 up to 3bar thread 1/8" connection on the backside		

GASTROPARTS.COM

