



GASTROPARTS

ATA

- [EN]** Equipment
- [DE]** Geräte
- [ES]** Aparatos
- [FR]** Équipement
- [IT]** Attrezzature
- [PL]** Urządzenia
- [RU]** Оборудование

✉ gastroparts@gastroparts.com

☎ +48 56 657 00 66

📘 fb.com/gastroparts.global

GASTROPARTS.COM







heating elements



coil heating elements

			
Part No.	420064	Ref. No.	13160
description	heating element 1000W 220V L 460mm W 50mm H 25mm tube ø 8.5mm thread M14x1.5 connection M6 dry heating element heating circuits 1 2 hole fixing		
For models:	AZ75, AZ80, AZ90, AZ91		

accessories for	415249		
	Part No.	550002	Ref. No. —
	tension strap H 10mm L 21mm W 10mm hole ø 6.5mm for heating element		
	Part No.	550362	Ref. No. —
	blind flange ø 64mm mounting ø 47.5mm		

immersion heating elements

3 hole flange ø57.5mm

			
Part No.	415021	Ref. No.	6201
description	heating element 6000W 230V mounting ø 57.5mm heating circuits 3 L 343mm W 37mm H 50mm number of thermostat sleeves 1 thermostat sleeves ø 7mm length thermostat sleeves 294mm thermostat sleeve not clinging tube ø 8.5mm hole distance 72mm hole ø 8mm connection M5 3 hole flange		
spare parts for	415021		
	Part No.	510409	Ref. No. —
	O-ring EPDM thickness 5.34mm ID ø 56.52mm Qty 1 pcs		
accessories for	415021		
	Part No.	550002	Ref. No. —
	tension strap H 10mm L 21mm W 10mm hole ø 6.5mm for heating element		





Part No.	415043	Ref. No.	7204
description	heating element 2500W 230V heating circuits 1 mounting ø 47.5mm L 225mm W 41mm H 36mm round flange connection male faston 6.3mm immersion heater tube ø 6.5mm connection length 17mm thermostat sleeves ø 7mm number of thermostat sleeves 1 length thermostat sleeves 210mm thermostat sleeve eccentric, non clinging		
For models:	AL03, AL05, AL05D, AL07, AL07D, AL09, AL09D, AL10, AL11, AL15, AL16, AL20, AL20D, AL21, AL25, AL25D, AL26, AL30, AL31, AL35, AL36, AL40, AL402, AL40D, AL40E, AL40PS, AL41, AL41E, AL45, AL45D, AL45E, AL45PS, AL46, AL46E, AL50, AL50PS, AL54, AL54D, AL55, AL55D, AL55PS, AL60, AL60PS, KYRA1, KYRA1WAG		

spare parts for	415043		
	Part No.	510408	Ref. No. 4207
	O-ring EPDM thickness 5.34mm ID ø 47mm Qty 1 pcs		

accessories for	415043		
	Part No.	510408	Ref. No. 4207
	O-ring EPDM thickness 5.34mm ID ø 47mm Qty 1 pcs		

	Part No.	510562	Ref. No. —
	O-ring silicone thickness 5.34mm ID ø 47mm Qty 1 pcs		





	Part No.	520235	Ref. No. —
	3 hole flange hole distance 70.5mm perforation ø 6.5mm ID ø 53.5mm		

	Part No.	520236	Ref. No. —
	flange for heating element ID ø 50mm ED ø 90mm hole ø 6.5mm 3 holes		

	Part No.	550002	Ref. No. —
	tension strap H 10mm L 21mm W 10mm hole ø 6.5mm for heating element		

	Part No.	550362	Ref. No. —
	blind flange ø 64mm mounting ø 47.5mm		

with round flange ø47.5mm

			
Part No.	415249	Ref. No.	7609
description	heating element 1500W 220V heating circuits 1 mounting ø 47.5mm L 220mm W 36mm H 49mm round flange connection male faston 6.3mm immersion heater tube ø 6.5mm connection length 18mm thermostat sleeves ø 7.5mm number of thermostat sleeves 1 length thermostat sleeves 181mm thermostat sleeve not clinging		
For models:	AL07, AL07D, AL09, AL09D, AL10, AL11, AL15, AL16, AL20, AL21, AL25, AL26		
spare parts for	415249		
	Part No.	510408	Ref. No. 4207
	O-ring EPDM thickness 5.34mm ID ø 47mm Qty 1 pcs		
accessories for	415249		
	Part No.	510562	Ref. No. —
	O-ring silicone thickness 5.34mm ID ø 47mm Qty 1 pcs		
	Part No.	520235	Ref. No. —
	3 hole flange hole distance 70.5mm perforation ø 6.5mm ID ø 53.5mm		
	Part No.	520236	Ref. No. —
	flange for heating element ID ø 50mm ED ø 90mm hole ø 6.5mm 3 holes		

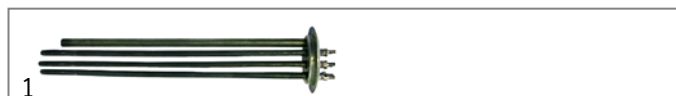

Part No.	415044	Ref. No.	4205
description	heating element 3000W 230V heating circuits 3 mounting ø 47.5mm L 270mm W 37mm H 28mm round flange connection M4 immersion heater tube ø 6.3mm thermostat sleeves ø 7mm number of thermostat sleeves 1 length thermostat sleeves 225mm		

For models:	AF55, AF61ED, AF73, AF73PS, AF78, AF78ED, AF78EDP, AF78PS, AF88, AF880, AF88E, AF88EP, AL40E, AL40ET, AL41E, AL45E, AL45ET, AL46E, AL50, AL50PS, AL54, AL54D, AL55, AL55D, AL55PS, AL60, AL60PS, ALP33, ALP33E, ALP42, ALP42P, ALP44, ALP44P, AT105, AT1050, AT105E, AT110, AT110E, AT112, AT114, AT116, AT95		
--------------------	---	--	--

accessories for	415044		
	Part No.	510408	Ref. No. 4207
	O-ring EPDM thickness 5.34mm ID ø 47mm Qty 1 pcs		

Table continues overleaf



accessories for		415044		
	Part No.	510562	Ref. No.	—
	O-ring silicone thickness 5.34mm ID ø 47mm Qty 1 pcs			
	Part No.	520235	Ref. No.	—
	3 hole flange hole distance 70.5mm perforation ø 6.5mm ID ø 53.5mm			
	Part No.	520236	Ref. No.	—
	flange for heating element ID ø 50mm ED ø 90mm hole ø 6.5mm 3 holes			
	Part No.	521103	Ref. No.	—
	nut thread M4 H 3mm WS 7 brass Qty 20 pcs			
	Part No.	521104	Ref. No.	—
	washer ID ø 4.3mm ED ø 8mm thickness 0.5mm brass Qty 20 pcs for thread M4			
	Part No.	550002	Ref. No.	—
	tension strap H 10mm L 21mm W 10mm hole ø 6.5mm for heating element			
	Part No.	550362	Ref. No.	—
	blind flange ø 64mm mounting ø 47.5mm			
	Part No.	560111	Ref. No.	—
	plain washer ID ø 4.3mm ED ø 9mm thickness 0.8mm SS Qty 20 pcs DIN 125A for thread M4			
	Part No.	560131	Ref. No.	—
	hexagonal nut thread M4 H 3.2mm WS 7 SS DIN/ISO DIN 934 / ISO 4032/8673 Qty 20 pcs			

accessories for		415045		
	Part No.	415045	Ref. No.	5205
	heating element 4500W 230V heating circuits 3 mounting ø 47.5mm L 372mm W 38mm H 28mm round flange connection M4 immersion heater tube ø 6.3mm thermostat sleeves ø 7mm length thermostat sleeves 235mm			
	For models: AF61, AF610, AF610D, AF610PS, AF610PSW, AF610W, AF61D, AF61DPS, AF61E, AF61EPS, AF61EW, AF61EWP, AF61PS, AF61PSW, AF61W, AF73, AF73PS, AF78, AF78DPS, AF78PS, AF83, AF88, ALC100, ALP01, ALP01E, ALP01EG, ALP01G, ALP02, ALP33, ALP33E, ALP42, ALP42P, ALP44, ALP44P, AME540, AT105, AT1050, AT105E, AT106, AT110, AT110E, AT116, ATR161, ATR221, ATR311, ATR75			
	Part No.	510408	Ref. No.	4207
	O-ring EPDM thickness 5.34mm ID ø 47mm Qty 1 pcs			
	Part No.	510562	Ref. No.	—
	O-ring silicone thickness 5.34mm ID ø 47mm Qty 1 pcs			
	Part No.	520235	Ref. No.	—
	3 hole flange hole distance 70.5mm perforation ø 6.5mm ID ø 53.5mm			
	Part No.	520236	Ref. No.	—
	flange for heating element ID ø 50mm ED ø 90mm hole ø 6.5mm 3 holes			
	Part No.	521103	Ref. No.	—
	nut thread M4 H 3mm WS 7 brass Qty 20 pcs			
	Part No.	521104	Ref. No.	—
	washer ID ø 4.3mm ED ø 8mm thickness 0.5mm brass Qty 20 pcs for thread M4			
	Part No.	550002	Ref. No.	—
	tension strap H 10mm L 21mm W 10mm hole ø 6.5mm for heating element			



accessories for		415045		
	Part No.	550362	Ref. No.	—
	blind flange ø 64mm mounting ø 47.5mm			
	Part No.	560111	Ref. No.	—
	plain washer ID ø 4.3mm ED ø 9mm thickness 0.8mm SS Qty 20 pcs DIN 125A for thread M4			
	Part No.	560131	Ref. No.	—
	hexagonal nut thread M4 H 3.2mm WS 7 SS DIN/ISO DIN 934 / ISO 4032/8673 Qty 20 pcs			



accessories for		416029		
	Part No.	416029	Ref. No.	6205
	heating element 6000W 230V heating circuits 3 mounting ø 47.5mm L 490mm W 36mm H 39mm immersion heater tube ø 6.3mm thermostat sleeves ø 7.5mm number of thermostat sleeves 1 length thermostat sleeves 235mm thermostat sleeve eccentric, non clinging			
	For models: ALC100, ALP02, ALP02E, ALP02EG, ALP02G, AT105, AT106, AT112, AT114, AT95, ATR161, ATR221			
	Part No.	510408	Ref. No.	4207
	O-ring EPDM thickness 5.34mm ID ø 47mm Qty 1 pcs			
	Part No.	510562	Ref. No.	—
	O-ring silicone thickness 5.34mm ID ø 47mm Qty 1 pcs			
	Part No.	520235	Ref. No.	—
	3 hole flange hole distance 70.5mm perforation ø 6.5mm ID ø 53.5mm			
	Part No.	520236	Ref. No.	—
	flange for heating element ID ø 50mm ED ø 90mm hole ø 6.5mm 3 holes			
	Part No.	550002	Ref. No.	—
	tension strap H 10mm L 21mm W 10mm hole ø 6.5mm for heating element			
	Part No.	550362	Ref. No.	—
	blind flange ø 64mm mounting ø 47.5mm			



accessories for		415808		
	Part No.	415808	Ref. No.	5505
	heating element 6500W 230V heating circuits 3 mounting ø 47.5mm L 375mm W 38mm H 30mm round flange connection M4 immersion heater tube ø 6.5mm thermostat sleeves ø 8.5mm number of thermostat sleeves 1 length thermostat sleeves 235mm thermostat sleeve eccentric, non clinging			
	For models: AF78, AF780, AF780D, AF780PS, AF780PSW, AF780W, AF78D, AF78DPS, AF78E, AF78EPS, AF78EW, AF78EWP, AF78PS, AF78PSW, AF78W, AF88, AF880, AF88E, AF88EP, AT900, ATR100, ATR130, ATR160, ATR75			
	Part No.	510408	Ref. No.	4207
	O-ring EPDM thickness 5.34mm ID ø 47mm Qty 1 pcs			
	Part No.	510562	Ref. No.	—
	O-ring silicone thickness 5.34mm ID ø 47mm Qty 1 pcs			
	Part No.	520235	Ref. No.	—
	3 hole flange hole distance 70.5mm perforation ø 6.5mm ID ø 53.5mm			



Table continues overleaf











accessories for	415808		
	Part No.	520236	Ref. No. —
	flange for heating element ID ø 50mm ED ø 90mm hole ø 6.5mm 3 holes		
	Part No.	550002	Ref. No. —
	tension strap H 10mm L 21mm W 10mm hole ø 6.5mm for heating element		
	Part No.	550362	Ref. No. —
	blind flange ø 64mm mounting ø 47.5mm		

			
Part No.	420344	Ref. No.	9699
description	heating element 9000/9840W 220/230V heating circuits 3 mounting ø 47.5mm L 495mm W 37mm H 33mm round flange connection M4 immersion heater tube ø 8.5mm thermostat sleeves ø 7.5mm number of thermostat sleeves 1 length thermostat sleeves 290mm thermostat sleeve eccentric, non clinging		
For models:	ATR130, ATR130ED, ATR160, ATR190AED, ATR75		
accessories for	420344		
	Part No.	510408	Ref. No. 4207
	O-ring EPDM thickness 5.34mm ID ø 47mm Qty 1 pcs		
	Part No.	510562	Ref. No. —
	O-ring silicone thickness 5.34mm ID ø 47mm Qty 1 pcs		

			
Part No.	420343	Ref. No.	6605
description	heating element 9000W 220V heating circuits 3 mounting ø 47.5mm L 535mm W 37mm H 38mm round flange connection M4 immersion heater tube ø 6.2mm thermostat sleeves ø 7mm number of thermostat sleeves 1 length thermostat sleeves 235mm thermostat sleeve eccentric, non clinging		
For models:	ATR161, ATR221, ATR311		
accessories for	420343		
	Part No.	510408	Ref. No. 4207
	O-ring EPDM thickness 5.34mm ID ø 47mm Qty 1 pcs		
	Part No.	510562	Ref. No. —
	O-ring silicone thickness 5.34mm ID ø 47mm Qty 1 pcs		

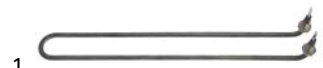
			
Part No.	415042	Ref. No.	1020
description	heating element 2200W 230V heating circuits 1 thread 1 1/4" L 165mm W 35mm H 26mm tube ø 6.3mm connection M4 immersion heater flange with thread		
spare parts for	415042		
	Part No.	510405	Ref. No. —
	flat gasket fibre ED ø 56mm ID ø 42mm thickness 2mm for thread 1 1/4" Qty 1 pcs		
accessories for	415042		
	Part No.	520232	Ref. No. —
	nut thread 1 1/4" H 5mm nickel-plated brass WS 47 Qty 1 pcs		

accessories for	415042		
	Part No.	521103	Ref. No. —
	nut thread M4 H 3mm WS 7 brass Qty 20 pcs		
	Part No.	521104	Ref. No. —
	washer ID ø 4.3mm ED ø 8mm thickness 0.5mm brass Qty 20 pcs for thread M4		
	Part No.	528021	Ref. No. —
	flat gasket PTFE ED ø 53mm ID ø 42.5mm thickness 3mm Qty 1 pcs equiv. no. 12001/02286 suitable for Astoria/Aurora/Brasilia/Wega		
	Part No.	560111	Ref. No. —
	plain washer ID ø 4.3mm ED ø 9mm thickness 0.8mm SS Qty 20 pcs DIN 125A for thread M4		
	Part No.	560131	Ref. No. —
	hexagonal nut thread M4 H 3.2mm WS 7 SS DIN/ISO DIN 934 / ISO 4032/8673 Qty 20 pcs		

			
Part No.	415330	Ref. No.	1102
description	heating element 1500W 230V heating circuits 1 L 310mm W 36mm H 16mm thread M10x1 mounting distance 30mm tube ø 6.3mm connection male faston 6.3mm 2 hole fixing immersion heater		
For models:	AL03, AL05, AL05D, AL10, AL20, AL20D, AL25, AL25D, AL402		
accessories for	415330		
	Part No.	510416	Ref. No. —
	flat gasket fibre ED ø 19mm ID ø 10.5mm thickness 1.5mm for thread M10 Qty 1 pcs		
	Part No.	510893	Ref. No. —
	O-ring EPDM thickness 2.62mm ID ø 9.92mm Qty 1 pcs		
	Part No.	520231	Ref. No. —
	nut thread M10x1 H 6mm WS 14 zinc-coated steel Qty 1 pcs		
	Part No.	521129	Ref. No. —
	nut thread M10 H 6mm SS WS 17 Qty 1 pcs DIN/ISO DIN 439		







			
Part No.	416127	Ref. No.	6816
description	heating element 1800W 230V heating circuits 1 L 318mm W 36mm H 22mm thread M10x1 mounting distance 30mm tube ø 6.3mm connection male faston 6.3mm 2 hole fixing immersion heater		
For models:	AL10, AL11, AL15, AL16, AL40, AL40D, AL40E, AL40PS, AL41E, AL45, AL45D, AL45E, AL45PS, AL46E, KYRA1, KYRA1WAG		
accessories for	416127		
	Part No.	510416	Ref. No. —
	flat gasket fibre ED ø 19mm ID ø 10.5mm thickness 1.5mm for thread M10 Qty 1 pcs		
	Part No.	510893	Ref. No. —
	O-ring EPDM thickness 2.62mm ID ø 9.92mm Qty 1 pcs		
	Part No.	520231	Ref. No. —
	nut thread M10x1 H 6mm WS 14 zinc-coated steel Qty 1 pcs		

Table continues overleaf





accessories for	416127			
	Part No.	521129	Ref. No.	—
	nut thread M10 H 6mm SS WS 17 Qty 1 pcs DIN/ISO DIN 439			

			
Part No.	415248	Ref. No.	4360
description	heating element 2000W 230V heating circuits 1 L 415mm W 32mm H 100mm L1 10mm L2 70mm L3 335mm W1 65mm W2 35mm thread M10x1 mounting distance 25mm tube ø 6.3mm 2 hole fixing immersion heater connection M4		
For models:	AF61, AF610, AF610D, AF610PS, AF610PSW, AF610W, AF61D, AF61DPS, AF61E, AF61ED, AF61EPS, AF61EW, AF61EWP, AF61PS, AF61PSW, AF61W, AF78, AF780, AF780D, AF780PS, AF780PSW, AF780W, AF78D, AF78DPS, AF78E, AF78ED, AF78EDP, AF78EPS, AF78EW, AF78EWP, AF78PS, AF78PSW, AF78W, AME540		

spare parts for	415248			
	Part No.	510893	Ref. No.	—
	O-ring EPDM thickness 2.62mm ID ø 9.92mm Qty 1 pcs			

accessories for	415248			
	Part No.	510416	Ref. No.	—
	flat gasket fibre ED ø 19mm ID ø 10.5mm thickness 1.5mm for thread M10 Qty 1 pcs			

	Part No.	516135	Ref. No.	4367
	insulation			

	Part No.	520231	Ref. No.	—
	nut thread M10x1 H 6mm WS 14 zinc-coated steel Qty 1 pcs			

	Part No.	521103	Ref. No.	—
	nut thread M4 H 3mm WS 7 brass Qty 20 pcs			

	Part No.	521104	Ref. No.	—
	washer ID ø 4.3mm ED ø 8mm thickness 0.5mm brass Qty 20 pcs for thread M4			

	Part No.	521129	Ref. No.	—
	nut thread M10 H 6mm SS WS 17 Qty 1 pcs DIN/ISO DIN 439			

	Part No.	560111	Ref. No.	—
	plain washer ID ø 4.3mm ED ø 9mm thickness 0.8mm SS Qty 20 pcs DIN 125A for thread M4			

	Part No.	560131	Ref. No.	—
	hexagonal nut thread M4 H 3.2mm WS 7 SS DIN/ISO DIN 934 / ISO 4032/8673 Qty 20 pcs			

			
Part No.	418904	Ref. No.	4359
description	heating element 2000W 380V heating circuits 1 L 415mm W 100mm L1 10mm L2 70mm L3 335mm W1 65mm W2 35mm thread M10x1 mounting distance 25mm tube ø 6.3mm 2 hole fixing immersion heater connection M4		

hot plates

square & rectangular

with radiused edge



Part No.	490056 [†]	Ref. No.	K24011
description	hot plate dimensions 300x300mm 3000W 230V with spill ring connection 4 screw clamps protector yes square		

[†]incl. protector

thermostats

bi-metal thermostats

safety bi-metal thermostats



Part No.	390420	Ref. No.	4280
description	bi-metal safety thermostat switch-off temp. 110°C 1-pole		
For models:	AF55, AF61, AF610, AF610D, AF610PS, AF610PSW, AF610W, AF61D, AF61DPS, AF61E, AF61ED, AF61EPS, AF61EW, AF61EWP, AF61PS, AF-61PSW, AF61W, AF78, AF780, AF780D, AF780PS, AF780PSW, AF780W, AF78D, AF78DPS, AF78E, AF78ED, AF78EDP, AF78EPS, AF78EW, AF78EWP, AF78PS, AF78PSW, AF78W, AF88, AF880, AF88E, AF88EP, AL03, AL05, AL05D, AL07, AL07D, AL09, AL09D, AL10, AL11, AL15, AL16, AL20...(Other models you can see in the webshop)		

bi-metal thermostats



Part No.	390231	Ref. No.	7680
description	bi-metal thermostat hole distance 40mm switch-off temp. 55°C 1CO 1-pole 16A connection F6.3 2 hole fixing		
For models:	AL03, AL05, AL05D, AL10, AL20		



control and safety thermostats

IMIT / TEMPOMATIC / ARTHERMO



control thermostats



Part No.	390421	Ref. No.	7608
description	thermostat t.max. 85°C temperature range 0-90°C 1-pole 1CO 16A probe ø 6.5mm probe L 95mm capillary pipe 1500mm capillary pipe isolated 1450mm gland nut shaft ømm shaft Lmm shaft position rotation 270° probe material copper		
For models:	AF55, AL03, AL05, AL05D, AL07, AL07D, AL09, AL09D, AL10, AL11, AL15, AL16, AL20, AL20D, AL21, AL25, AL25D, AL26, AL40, AL40D, AL40PS, AL45, AL45D, AL45PS, AL54, AL54D, AL55, AL55D, AL55PS, ATR75, KYRA1, KYRA1WAG		



Part No.	390006	Ref. No.	2080 7280
description	thermostat t.max. 86°C temperature range 0-86°C 1-pole 1CO 16A probe ø 6.5mm probe L 95mm capillary pipe 1500mm capillary pipe isolatedmm gland nut shaft ø 6x4.6mm shaft L 19mm rotation 270°		
For models:	AF61, AF73, AF73PS, AF78, AF78PS, AF83, AF88, AL30, AL31, AL35, AL36, AL40, AL41, AL45, AL46, AL50, AL50PS, AL60, AL60PS, AT105, AT95		

accessories for	390006		
	Part No.	110100	Ref. No. —
	knob thermostat t.max. 90°C 0-90°C ø 42mm shaft ø 6x4.6mm shaft flat -135° black		
	Part No.	110105	Ref. No. —
	rosette knob ø 42mm ø 56mm zero mark		



Part No.	390399	Ref. No.	1080 1080 neu
description	thermostat t.max. 90°C temperature range°C 1-pole 1CO 16A probe ø 6.5mm probe L 110mm capillary pipe 1500mm capillary pipe isolated 1450mm shaft ø 6x4.6mm shaft L 19mm shaft position +135° rotation 270°		
For models:	AF61, AF61D, AF61DPS, AF61PS, AF61PSW, AF61W, AF73, AF73PS, AF78, AF78D, AF78DPS, AF78PS, AF78PSW, AF78W, AF83, AF88, AL10, AL15, AL20, AL25, AL30, AL31, AL35, AL36, AL40, AL40PS, AL41, AL45, AL45PS, AL46, AL50, AL50PS, AL60, AL60PS, ALC100, ALP01, ALP01G, ALP02, ALP02G, ALP33, ALP42, ALP42P, AME540, AT105, AT106, AT110, AT900, AT95, ATR161, ATR221...(Other models you can see in the webshop)		

safety thermostats





Part No.	390770	Ref. No.	13121
description	safety thermostat switch-off temp. 90-110°C 1-pole 1CO 16/0.5A probe ø 6.5mm probe L 90mm capillary pipe 2000mm capillary pipe isolated 1950mm gland nut probe		
For models:	ALC100, ALP01, ALP01E, ALP01EG, ALP02, ATR161, ATR221, ATR311, AZ80, AZ90, AZ91		

switches and momentary switches

rocker/momentary rocker switches

30x22mm

	Part No.	301001	Ref. No.	1089
description	rocker switch mounting measurements 30x22mm red 2NO 250V 16A illuminated 0-I connection male faston 6.3mm ambient temperature max. 125/55°C protection IP65			
accessories for	301001			
	Part No.	301036	Ref. No.	—
	protective cover internal size 30x22mm for rocker switch mounting measurementsmm			

	Part No.	301015	Ref. No.	1087
description	rocker switch mounting measurements 30x22mm red 2CO 250V 16A illuminated connection male faston 6.3mm ambient temperature max. 125/55°C protection IP40			

push/momentary push switches

20.6x16.4mm





	Part No.	347885	Ref. No.	6871
description	momentary push switch mounting ø 20.6x16.4mm beige 1NO 250V 16A connection male faston 6.3mm pump ambient temperature max. 150°C protection IP40			
For models:	AF55, AL20, AL20D, AL25, AL25D			
spare parts for	347885			
	Part No.	345130	Ref. No.	—
	momentary switch unit 1NO 250V 16A connection male faston 6.3mm			

Table continues overleaf



spare parts for	347885			
	Part No.	345537	Ref. No.	—
	element holder mounting measurements 20.6x16.4mm grey arched for push buttons 13x17mm			

1 				
Part No.	347886	Ref. No.	6837	
description	momentary push switch mounting ø 20.6x16.4mm dark grey 1NO 250V 16A connection male faston 6.3mm ambient temperature max. 150°C protection IP40			
For models:	AL40, AL40D, AL40PS, AL45, AL45D, AL45PS			
spare parts for	347886			
	Part No.	345130	Ref. No.	—
	momentary switch unit 1NO 250V 16A connection male faston 6.3mm			

28.5x28.5mm

1 			
Part No.	345452	Ref. No.	4232
description	momentary push switch mounting measurements 28.5x28.5mm green 1CO 250V 16A connection male faston 6.3mm ambient temperature max. 150°C protection IP40		
For models:	AF73, AF73PS, AF78, AF78PS, AF83, AF88, AT105, AT106		

28.5x52.6mm

1 			
Part No.	345463	Ref. No.	4716
description	double momentary switch mounting measurements 28.5x52.6mm green/white 2NO/1CO 250V 16A connection male faston 6.3mm ambient temperature max. 85°C protection IP40		
For models:	AL03, AL05D, AL07, AL07D, AL09D, AL54, AL54D, AL55, AL55D, AL55PS		

1 			
Part No.	345465	Ref. No.	7373
description	switch combination latching mounting measurements 28.5x52.6mm grey/clear 2CO/indicator light 250V 16A connection male faston 6.3mm ambient temperature max. 150°C protection IP40		
For models:	AL05D, AL07D, AL09D, AL54D, AL55D, AL55PS		



28.5x77.5mm

1 			
Part No.	345434	Ref. No.	7208
description	switch combination latching mounting measurements 28.5x77.5mm green/white/blue 2CO/indicator light/indicator light 250V 16A connection male faston 6.3mm ambient temperature max. 85°C protection IP40		
For models:	AL31, AL36, AL41, AL46		

1 			
Part No.	345027	Ref. No.	7205
description	switch combination mounting measurements 28.5x77.5mm white/blue/green 2CO/2NO/1NO 250V 16A with indicator green/red connection male faston 6.3mm ambient temperature max. 85°C protection IP40		
For models:	AL30, AL31, AL35, AL36, AL40, AL41, AL45, AL46, AL50, AL50PS, AL60, AL60PS		

1 			
Part No.	345464	Ref. No.	7372
description	switch combination mounting measurements 28.5x77.5mm white/blue/green 2NO/1NO/1NO 250V 16A connection male faston 6.3mm ambient temperature max. 85°C protection IP40		
For models:	AL05, AL09		

ø16mm

1 				
Part No.	347906	Ref. No.	5811	
description	momentary push switch mounting ø 16mm green 1NO/1NC 250V 16A connection male faston 6.3mm protection IP40 ambient temperature max. 150°C			
For models:	AF61, AF61D, AF61PS, AF61PSW, AF61W, AF78, AF78D, AF78PS, AF78PSW, AF78W, AF88			
spare parts for	347906			
	Part No.	345536	Ref. No.	—
	element holder mounting ø 16mm flat black			
	Part No.	346202	Ref. No.	—
	push button ø 11.9mm green			



			
1			
Part No.	345128	Ref. No.	7954
description	momentary push switch mounting ø 16mm green 2CO 250V 5A illuminated connection soldering connection ambient temperature max. 85°C protection IP40		
For models:	AF61, AL30, AL31, AL35, AL36, AL40, AL41, AL45, AL46		

			
1			
Part No.	345462	Ref. No.	6954
description	momentary push switch mounting ø 16mm green 2NO 250V 16A connection male faston 6.3mm protection IP40 ambient temperature max. 150°C		
For models:	AF61, AF61D, AF61DPS, AF61PS, AF61PSW, AF61W, AF78, AF78D, AF78DPS, AF78PS, AF88, AL30, AL31, AL35, AL36, AL40, AL40PS, AL41, AL45, AL45PS, AL46, AME540		

microswitches

lever actuated

			
1			
Part No.	345459	Ref. No.	7607 k24039
description	microswitch with lever 250V 15A 1NC connection male faston 6.3mm ambient temperature max. 85°C mounting distance 15-25mm ROLD lever length 66mm series RM		
For models:	AL10, AL11, AL15, AL16, AL20, AL21, AL25, AL26, ALP42, ALP42P, ALP44, ALP44P, AT105E, AT110E, AT112, AT114, AT116		

pin-plunger actuated

M10

			
1			
Part No.	345032	Ref. No.	4203
description	microswitch with plunger thread M10x1 thread L 12mm 250V 16A 1CO connection male faston 6.3mm stroke 7mm mounting distance 22mm L 28mm ambient temperature max. 125°C type SP9603 actuating force: 180g		
For models:	AF73, AF73PS, AF78, AF78PS, AF83, AF88, AL30, AL31, AL35, AL36, AL40, AL41, AL45, AL46, AL50, AL50PS, AL60, AL60PS, AT105, AT106		

non-standard

			
1			
Part No.	345460	Ref. No.	7620
description	microswitch with plunger 250V 15A 1NO connection male faston 6.3mm L 37.5mm ambient temperature max. 85°C mounting distance 16mm actuating force: 850g black		
For models:	AL10, AL20		

accessories



			
1			
Part No.	516249	Ref. No.	7613
description	hexagonal screw thread M5 WS 8		
For models:	AL10, AL11, AL15, AL16, AL20, AL21, AL25, AL26		

position switches

LOVATO

			
1			
Part No.	347908	Ref. No.	13123 K24082 + 10000
description	position switch plastic 1NO/1NC 400V 3A L 110mm W 30mm H 44mm protection IP66/67 actuating force: 380g screw connection M16 mounting distance 22mm type ZCP21		
For models:	ALC100, AT105E, AT110E, AT116, ATR100, ATR130, ATR130ED, ATR160, ATR161, ATR190AED, ATR221, ATR311, AZ80		

system switches (ROLD)

			
1			
Part No.	359350	Ref. No.	7224
description	indicator light 230V blue connection male faston 6.3mm ø 11mm		
For models:	AL03, AL05, AL05D, AL07, AL07D, AL09, AL09D, AL50, AL50PS, AL54, AL54D, AL55, AL55D, AL55PS, AL60, AL60PS		
accessories for	359350		
	Part No.	345601	Ref. No.
			—
	 indicator lamp holder V ø 11mm		

			
1			
Part No.	346817	Ref. No.	7617/G
description	push button ø 23mm white		
For models:	AL15, AL16, AL25, AL26		



float switches

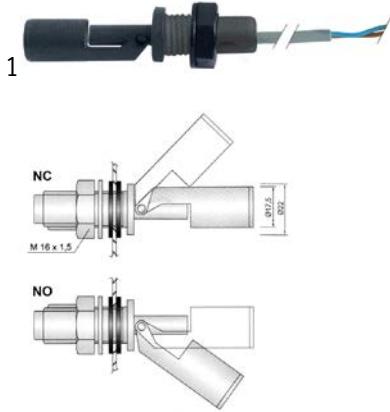

Part No.	345484	Ref. No.	5692
description	float switch thread M16x1.5 1NO or 1NC ø 17.5mm L 92mm mounting ø 16mm 250V 1A cable cable length 2000mm		
For models:	AF610, AF610PSW, AF610W, AF61EW, AF61EWP, AF61PSW, AF61W, AF780PSW, AF780W, AF78EW, AF78EWP, AF78PSW, AF78W, ALP01, ALP01E, ALP01EG, ALP01G, ALP02, ALP02E, ALP02EG, ALP02G, AT105, AT105E, AT110, AT110E, AT116, AT95, ATR75, KYRA1WAG		

rotary switches

BRETER

rotary switches



Part No.	345022	Ref. No.	4277 old version
description	rotary switch 16A 3 operating positions 4-pole		



Part No.	345451	Ref. No.	4221 old version
description	rotary switch 16A shaft ø 5x5mm connection screw clamp 2 operating positions 2-pole		



Part No.	345467	Ref. No.	4274 old version
description	rotary switch 16A shaft ø 5x5mm connection screw clamp 2 operating positions 2-pole		



Part No.	345025	Ref. No.	4202 7606 old version
description	rotary switch 16A shaft ø 5x5mm connection screw clamp 2-pole		



Part No.	345456	Ref. No.	7952
description	rotary switch 16A shaft ø 5x5mm connection screw clamp 4-pole		
For models:	AL30, AL31, AL35, AL36, AL40, AL40PS, AL41, AL45, AL45PS, AL46		



Part No.	345455	Ref. No.	7951 old version
description	rotary switch 16A shaft ø 5x5mm connection screw clamp 5-pole		



Part No.	345453	Ref. No.	4235
description	rotary switch 2 0-1 sets of contacts 4 690V 16A shaft ø 5x5mm shaft L 20mm shaft square connection screw		
For models:	AF73PS, AF78PS, AL50PS, AL60PS		





Part No.	345448	Ref. No.	7950 old version
description	rotary switch 20A 2-pole		





Part No.	345468	Ref. No.	4276 old version
description	rotary switch 20A connection screw clamp 3 operating positions 7-pole		





			
1			
Part No.	347884	Ref. No.	4238
description	rotary switch 3 0-1-2 (momentary) sets of contacts 3 type LE2-16 690V 16A shaft ø 5x5mm shaft L 15mm shaft square connection screw		
For models:	AME540		

			
1			
Part No.	347909	Ref. No.	14122
description	rotary switch 3 1-0-2 sets of contacts 4 type LE2-12-3252 600V 12A shaft ø 9x8mm shaft L 20mm shaft star-shaped connection screw		
For models:	ALP01, ALP01G, ALP02, ALP02G		
accessories for	347909		
	Part No.	347910	Ref. No. 14135
	knob dimensions 22mm shaft ø 9x7mm		

			
1			
Part No.	345469	Ref. No.	4275 old version
description	rotary switch connection screw clamp 3 operating positions 4-pole		

			
1			
Part No.	345449	Ref. No.	6827 old version
description	rotary switch type 194L-E16 690V 16A connection screw		

accessories			
			
1			
Part No.	347910	Ref. No.	14135
description	knob dimensions 22mm shaft ø 9x7mm		
For models:	ALP01, ALP01G, ALP02, ALP02G, ALP33, ALP42, ALP42P		

LOVATO			
			
1			
Part No.	346234	Ref. No.	7950
description	rotary switch 2 0-1 sets of contacts 2 type GN20 9480 U 690V 20A shaft ø 6x6mm shaft L 23.5mm shaft square connection screw		
For models:	AF61, AF61W, AF78, AF78W, AF88, AL30, AL35, AL40, AL40D, AL45, AL45D		

			
1			
Part No.	346236	Ref. No.	4221
description	rotary switch 2 0-1 sets of contacts 2 type GN209477U 690V 20A shaft ø 5x5mm shaft L 15.5mm shaft square connection screw		
For models:	AF73, AF73PS, AF78, AF78PS, AF83, AF88		

			
1			
Part No.	346178	Ref. No.	7606
description	rotary switch 2 0-1 sets of contacts 2 type GN209479U 690V 20A shaft ø 6x6mm shaft L 23.5mm shaft square connection screw		
For models:	AF73, AF73PS, AF78, AF78PS, AF83, AF88, AL10, AL15, AL20, AL25, AZ80, AZ90, AZ91		

			
1			
Part No.	347174	Ref. No.	4274
description	rotary switch 2 1-2 sets of contacts 2 type GN209483U 690V 20A shaft ø 5x5mm shaft L 16mm shaft 23.5 connection screw		
For models:	AF61PS, AF78, AF78D, AF78PS, AF78PSW, AF78W, AF88		

			
1			
Part No.	346180	Ref. No.	4273
description	rotary switch 2 1-2 sets of contacts 3 type GN209484U 690V 20A shaft ø 6x6mm shaft L 23.5mm shaft square connection screw		
For models:	AF61D, AL40D, AL45D		



1

Part No.	347639	Ref. No.	6827
description	rotary switch 3 0-1 momentary switch sets of contacts 2 type GN209481U 690V 20A shaft \varnothing 5x5mm shaft L 16mm shaft square connection screw		
For models:	AL40, AL40PS, AL45, AL45PS		



1

Part No.	346179	Ref. No.	7951
description	rotary switch 3 1-0-2 sets of contacts 5 type GN209538U 690V 20A shaft \varnothing 5x5mm shaft L 17mm shaft square connection screw		
For models:	AF61D, AF61PS, AF61PSW, AF78D, AF78PS, AF78PSW, AL11, AL16, AL21, AL26, AL31, AL36, AL40PS, AL41, AL45PS, AL46		



1

Part No.	347631	Ref. No.	4275
description	rotary switch 3 1-2-3 sets of contacts 3 type GN209540U 690V 20A shaft \varnothing 5x5mm shaft L 16mm shaft square connection screw		
For models:	AF78DPS		



1

Part No.	346902	Ref. No.	4277
description	rotary switch 3 1-2-start sets of contacts 4 type GN209482U 690V 20A shaft \varnothing 6x6mm shaft L 23.5mm shaft square connection screw		
For models:	AF61, AF61D, AF61DPS, AF61PS, AF78		



1

Part No.	347180	Ref. No.	13126 13166
description	rotary switch 4 0-1-2-3 sets of contacts 8 type GX169536U11 600V 12A shaft \varnothing 6x6mm shaft L 26.5mm shaft square connection screw		
For models:	ALC100, ATR161, ATR221, ATR311		



1

Part No.	346903	Ref. No.	4276
description	rotary switch 4 1-2-3-start sets of contacts 7 type GN209539U 690V 20A shaft \varnothing 6x6mm shaft L 23.5mm shaft square connection screw		
For models:	AF78D, AF78DPS, AF78PS		



1

Part No.	346235	Ref. No.	9804
description	rotary switch 5 0-1-2-3-4 sets of contacts 6 type GN209478U 690V 20A shaft \varnothing 6x6mm shaft L 23.5mm shaft square connection screw		
For models:	AT105, AT110, AT900, AT95		



1

Part No.	347984	Ref. No.	4970
description	rotary switch 6 1-0-2-3-4-5 sets of contacts 8 type GN209537U 400V 20A shaft \varnothing 5x5mm shaft L 16.28mm shaft square connection screw suitable for ATA		
For models:	AT105, AT110, AT900, AT95		



1

Part No.	345458	Ref. No.	9804 old version
description	rotary switch type GN209478U 690V 20A shaft \varnothing 6x6mm shaft L 23.5mm shaft square connection screw		

magnetic switches

65x20mm



1

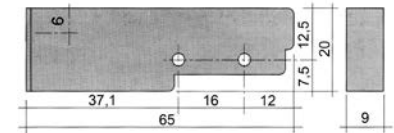

Part No.	347911	Ref. No.	13154
description	magnetic switch L 65mm W 20mm 1NO 24V 3A P max. 72W connection cable cable length 2000mm		
For models:	ALP01, ALP01E, ALP01EG, ALP01G, ALP02, ALP02E, ALP02EG, ALP02G, ALP42, ALP42P, ALP44, ALP44P, AT112, AT114, AT116, ATR75		

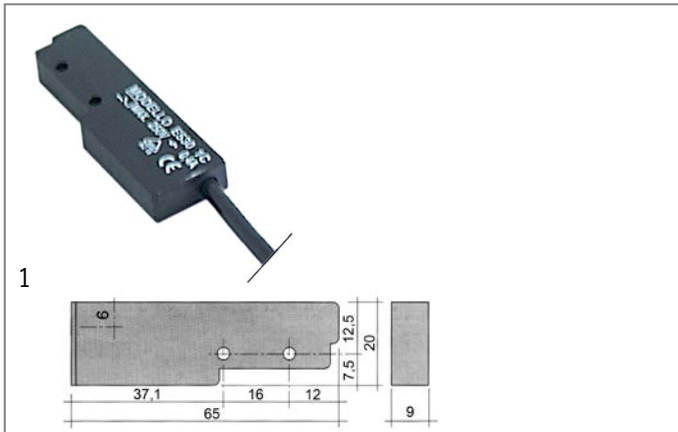

Part No.	345116	Ref. No.	13105 13122
description	magnetic switch L 65mm W 20mm 1NO 250V 0.4A P max. 100W connection cable cable length 3000mm		
For models:	AF55, AF61, AF610, AF610D, AF610PS, AF610PSW, AF610W, AF61D, AF61DPS, AF61PS, AF61PSW, AF61W, AF73, AF73PS, AF78, AF780, AF780D, AF780PS, AF780PSW, AF780W, AF78D, AF78DPS, AF78E, AF78ED, AF78EDP, AF78EPS, AF78PS, AF78PSW, AF78W, AF83, AF88, AF880, AF88E, AL03, AL05, AL05D, AL07, AL07D, AL09, AL09D, AL15, AL16, AL20, AL20D, AL25, AL25D, AL26, AL30, AL31, AL35...(Other models you can see in the webshop)		
accessories for	345116		
	Part No.	345399	Ref. No. —
	magnet ø 3.3mm L 40mm H 8mm W 13mm hole distance 30mm M3		

accessories

magnets

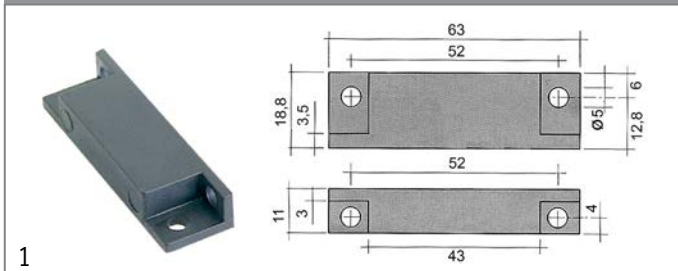

Part No.	345336	Ref. No.	13642 8441
description	magnet ø 4.8mm L 63mm H 11mm W 18.8mm hole distance 51mm M4		
For models:	AF55, AF61, AF610, AF610D, AF610PS, AF610PSW, AF610W, AF61D, AF61DPS, AF61E, AF61ED, AF61EPS, AF61EW, AF61EWP, AF61PS, AF61PSW, AF61W, AF73, AF73PS, AF78, AF780, AF780D, AF780PS, AF780PSW, AF780W, AF78D, AF78DPS, AF78E, AF78ED, AF78EDP, AF78EPS, AF78EW, AF78EWP, AF78PS, AF78PSW, AF78W, AF83, AF88, AF880, AF88E, AF88EP, AL03, AL05, AL05D, AL07, AL07D, AL09, AL09D, AL20, AL20D...(Other models you can see in the webshop)		

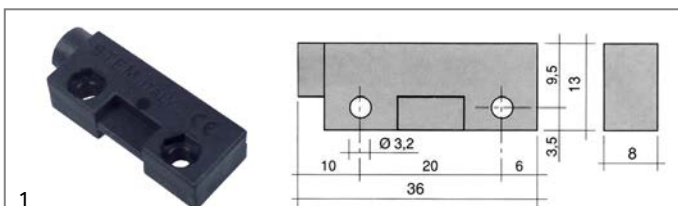

Part No.	345398	Ref. No.	7656
description	magnet ømm L 36mm H 8mm W 13mm hole distance 20mm M3 hole ø 3mm		
For models:	AL15, AL16, AL25, AL26		

Part No.	347887	Ref. No.	13453
description	magnet ømm L 79mm H 12mm W 19mm M7 hole ø 7mm		
For models:	ATR161, ATR221, ATR311		

control equipment

BRETER

Part No.	345786	Ref. No.	13151
description	contact block BRETER 1NC		
For models:	ATR221, ATR311		

Part No.	345640	Ref. No.	13149
description	contact block BRETER 1NO		
For models:	ATR221, ATR311		

rotary switches

Part No.	347907	Ref. No.	13125
description	rotary selector mounting measurements ø22mm black sequence 1-0-2		
For models:	ATR221, ATR311		

lamps

Part No.	359807	Ref. No.	13134
description	light bulb socket Ba9s 24V 2W ø 10mm L 28mm clear		
For models:	ALC100, ALP01, ALP01G, ALP02, ALP02G, ATR161, ATR221, ATR311		



lamps

indicator lights

indicator lights 2-piece (lens and indicator lamp)

indicator light lenses

ø10mm (type SRZ-3)



1

Part No.	359124	Ref. No.	7953
description	indicator light housings mounting measurements ø10mm yellow round Qty 1 pcs		
For models:	AF61, AF61D, AF61DPS, AF61PS, AF61PSW, AF61W, AF78, AF78D, AF78DPS, AF78PS, AF78PSW, AF78W, AF88, AL30, AL31, AL35, AL36, AL40, AL40D, AL40PS, AL41, AL45, AL45D, AL45PS, AL46, AME540, AT105, AT110, AT95		
accessories for	359124		
	Part No.	359132	Ref. No. 7216
	indicator lamp green 250V connection male faston 6.3mm protection IP54 ambient temperature max. 85°C		

indicator lamps for socket type SRZ / SDK / SDY / SFK



1

Part No.	359130	Ref. No.	7215
description	indicator lamp 230V clear connection male faston 6.3mm ø 8mm		



1

Part No.	359132	Ref. No.	7216
description	indicator lamp green 250V connection male faston 6.3mm protection IP54 ambient temperature max. 85°C		
For models:	AL03, AL05, AL05D, AL07, AL07D, AL09, AL09D, AL30, AL31, AL35, AL36, AL40, AL41, AL45, AL46, AL50, AL50PS, AL54, AL54D, AL55, AL55D, AL55PS, AL60, AL60PS		



1

Part No.	359350	Ref. No.	7224
description	indicator light 230V blue connection male faston 6.3mm ø 11mm		
For models:	AL03, AL05, AL05D, AL07, AL07D, AL09, AL09D, AL50, AL50PS, AL54, AL54D, AL55, AL55D, AL55PS, AL60, AL60PS		
accessories for	359350		
	Part No.	345601	Ref. No. —
	indicator lamp holder V ø 11mm		

indicator lights 3-piece (housing, lens and bulb)

lamps

light bulbs



1

Part No.	359807	Ref. No.	13134
description	light bulb socket Ba9s 24V 2W ø 10mm L 28mm clear		
For models:	ALC100, ALP01, ALP01G, ALP02, ALP02G, ATR161, ATR221, ATR311		

indicator lights (complete)

28.5x28.5mm

lamps (complete)



1

Part No.	359355	Ref. No.	4224
description	indicator light mounting measurements 28.5x28.5mm 230V blue		
For models:	AF73, AF73PS, AF78, AF78PS, AF83, AF88, AL10, AL11, AL15, AL16, AL20, AL21, AL25, AL26, AT105, AT106		



1

Part No.	359352	Ref. No.	7622
description	indicator light mounting measurements 28.5x28.5mm 230V clear		
For models:	AF73, AF73PS, AF78, AF78PS, AF83, AF88, AL10, AL11, AL15, AL16, AL20, AL21, AL25, AL26		



1

Part No.	359353	Ref. No.	4223
description	indicator light mounting measurements 28.5x28.5mm 230V green		
For models:	AF73, AF73PS, AF78, AF78PS, AF83, AF88, AL10, AL11, AL15, AL16, AL20, AL21, AL25, AL26, AT105, AT106		



1

Part No.	359356	Ref. No.	4225
description	indicator light mounting measurements 28.5x28.5mm 230V red		
For models:	AF73, AF73PS, AF78, AF78PS, AF83, AF88, AL50PS, AL60PS, AT105, AT106		



28.5x77.5mm



1

Part No.	359008	Ref. No.	7206
description	indicator light mounting measurements 28.5x77.5mm 230V white/blue/green connection male faston 6.3mm temp.-resist.°C		
For models:	AL03, AL05, AL05D, AL07, AL07D, AL09, AL09D, AL30, AL31, AL35, AL36, AL40, AL41, AL45, AL46, AL50, AL50PS, AL54, AL54D, AL55, AL55D, AL55PS, AL60, AL60PS		

screw-on/push-on fit

light bulbs

for indicator lights



1

Part No.	359807	Ref. No.	13134
description	light bulb socket Ba9s 24V 2W ø 10mm L 28mm clear		
For models:	ALC100, ALP01, ALP01G, ALP02, ALP02G, ATR161, ATR221, ATR311		

timers

programme timers



1

Part No.	360139	Ref. No.	9813
description	timer BIGATTI engines 2 chambers 4		
For models:	AT105, AT95		





1

Part No.	360572	Ref. No.	14126
description	timer CDC 4904DV engines 2 chambers 4 operation time 120s / 8min 24V 50/60Hz shaft ømm shaft Lmm motor type M48R ATS / M48L ATS voltage AC		
For models:	ALP01, ALP01G, ALP02, ALP02G		



1

Part No.	360144	Ref. No.	9815	
description	timer CDC 4904DV engines 2 chambers 4 operation time 60s/216s 230V shaft ømm shaft Lmm manuf. no. 4904DV / 360144 motor type M48R ATS / M48L ATS			
For models:	AT105, AT110, AT900, AT95			
spare parts for	360144			
	Part No.	360083	Ref. No.	—
	motor CDC pinion ø 4.9mm teeth 10 230V turn direction left motor ø 47mm H 19.3mm motor type M48L ATS for timer			
	Part No.	360118	Ref. No.	—
	motor CDC pinion ø 4.9mm teeth 10 230V voltage AC 50/60Hz turn direction right motor ø 47mm H 19.3mm motor type M48R ATS for timer cable length 260mm 1.9/2.5W			



1

Part No.	360571	Ref. No.	14633
description	timer CDC 4904DV engines 2 chambers 4 operation time 6s/150s 230V 50/60Hz shaft ømm shaft Lmm motor type M48R ATS / M48L ATS voltage AC operation time 120s/8min		
For models:	ALP33, ALP42, ALP42P		





1



Part No.	360142	Ref. No.	4717	
description	timer CDC 7803 engines 1 chambers 3 operation time 120s 230V shaft ømm shaft Lmm manuf. no. 7803F1 / 360142 motor type M37RN			
For models:	AF55, AL03, AL05, AL05D, AL07, AL07D, AL09, AL09D, AL10, AL11, AL15, AL16, AL20, AL20D, AL25, AL25D, AL40, AL40D, AL40PS, AL45, AL45D, AL45PS, AL54, AL54D, AL55, AL55D, AL55PS, KYRA1, KYRA1WAG			
spare parts for	360142			
	Part No.	360119	Ref. No.	—
	motor CDC pinion ø 5.4mm teeth 12 230V turn direction right motor ø 37mm motor type M37RN for timer			



1 electric components





			
1			
Part No.	360143	Ref. No.	4718
description	timer CDC 7803 engines 1 chambers 3 operation time 18min 230V manuf. no. 7803F1 / 360.143 motor type M37RN		
For models:	AL05D, AL07D, AL09D, AL40D, AL45D, AL54D, AL55D		
spare parts for	360143		
	Part No.	360119	Ref. No. —
	motor CDC pinion ø 5.4mm teeth 12 230V turn direction right motor ø 37mm motor type M37RN for timer		

			
1			
Part No.	360501	Ref. No.	4723
description	timer CDC 7903F1 engines 1 chambers 3 operation time 120s 230V motor type M37RN voltage AC		

			
1			
Part No.	360032	Ref. No.	2512
description	timer FIBER P37 engines 1 chambers 2 operation time 150s 230V shaft ø 6x4.6mm shaft L 18mm manuf. no. P375J02H435 motor type M51BJ0L6400		
spare parts for	360032		
	Part No.	360674	Ref. No. —
	motor kit pinion ø 6.8mm teeth 15 230V voltage AC 50/60Hz turn direction counterclockwise motor ø 48mm H 18.5mm motor type UDS40NE1RNZ165 cable length 150mm with holder		



			
1			
Part No.	360369	Ref. No.	7287
description	timer FIBER P37 engines 1 chambers 3 operation time 120s 230V shaft ømm shaft Lmm manuf. no. P375J03H340 motor type M51BJ0L***		
For models:	AF61, AF61D, AF61DPS, AF61PS, AF61PSW, AF61W, AL10, AL11, AL15, AL16, AL20, AL20D, AL25, AL25D		
spare parts for	360369		
	Part No.	360674	Ref. No. —
	motor kit pinion ø 6.8mm teeth 15 230V voltage AC 50/60Hz turn direction counterclockwise motor ø 48mm H 18.5mm motor type UDS40NE1RNZ165 cable length 150mm with holder		

			
1			
Part No.	360138	Ref. No.	7643
description	timer FIBER P37 engines 1 chambers 3 operation time 18min 230V shaft ømm shaft Lmm manuf. no. P375J03J931 motor type M51BJ0L6400		
For models:	AF61D, AF61DPS, AF78D, AF78DPS, AL11, AL16, AL20D, AL21, AL25D, AL26		
spare parts for	360138		
	Part No.	360674	Ref. No. —
	motor kit pinion ø 6.8mm teeth 15 230V voltage AC 50/60Hz turn direction counterclockwise motor ø 48mm H 18.5mm motor type UDS40NE1RNZ165 cable length 150mm with holder		

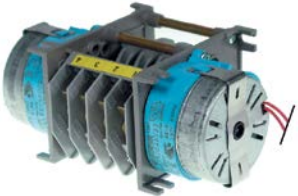
			
1			
Part No.	360141	Ref. No.	6680 6681
description	timer FIBER P37 engines 2 chambers 4 operation time 1min / 4min 230V shaft ømm shaft Lmm manuf. no. P375J04LW32 motor type M51BJ0L0000/M51BJ0R0000		
For models:	AT105, AT106		

1

Part No.	360355	Ref. No.	9816
description	timer FIBER P37 engines 2 chambers 4 operation time 60s / 216s 230V shaft ømm shaft Lmm manuf. no. P375J04AV33 motor type M51BJ0R6400 / M51BJ0L6400		
spare parts for	360355		
	Part No.	360673	Ref. No. —
	motor kit pinion ø 6.8mm teeth 15 230V voltage AC 50/60Hz turn direction clockwise motor ø 48mm H 18.5mm motor type UDS-40NE1RNZ165 cable length 150mm with holder		
	Part No.	360674	Ref. No. —
	motor kit pinion ø 6.8mm teeth 15 230V voltage AC 50/60Hz turn direction counterclockwise motor ø 48mm H 18.5mm motor type UDS40NE1RNZ165 cable length 150mm with holder		



1

Part No.	380213	Ref. No.	9800
description	power contactor resistive load 20A 230VAC (AC3/400V) 8.5A/5.5kW main contacts 3NO auxiliary contacts 1NO connection screw connection type Fanal DSL7 10 type ISKRA K07M 10		
For models:	AME540, AT105, AT110, AT95		

alarm devices

alarm units



1

Part No.	350065	Ref. No.	13120
description	alarm device		
For models:	AF55, AF61, AF61D, AF61DPS, AF61PS, AF61PSW, AF61W, AF78, AF78D, AF78DPS, AF78PS, AF78PSW, AF78W, AF88, AL07, AL07D, AL09, AL09D, AL10, AL11, AL15, AL16, AL20, AL20D, AL21, AL25, AL25D, AL26, AL30, AL31, AL35, AL36, AL40, AL40D, AL40PS, AL41, AL45, AL45D, AL45PS, AL46, AL54, AL54D, AL55, AL55D, AL55PS, ALC100, ALP01, ALP01G, ALP02, ALP02G...(Other models you can see in the webshop)		

contactors

ISKRA (FANAL)

power contactors



1

Part No.	380212	Ref. No.	4204
description	power contactor resistive load 20A 230VAC (AC3/400V) 8.5A/5.5kW main contacts 3NO auxiliary contacts 1NC connection screw connection type Fanal K07M 01 type ISKRA DSL7 01		
For models:	AF55, AF61, AF610, AF610D, AF610PS, AF610PSW, AF610W, AF61D, AF61DPS, AF61E, AF61ED, AF61EPS, AF61EW, AF61EWP, AF61PS, AF61PSW, AF61W, AF73, AF73PS, AF78, AF780, AF780D, AF780PS, AF780PSW, AF780W, AF78D, AF78DPS, AF78E, AF78ED, AF78EDP, AF78EPS, AF78EW, AF78EWP, AF78PS, AF78PSW, AF78W, AF83, AF88, AF880, AF88E, AF88EP, AL40E, AL41E, AL45E, AL46E, AL55, AL55D, AL55PS, ALP33, ALP33E...(Other models you can see in the webshop)		

LOVATO

power contactors



1

Part No.	380478	Ref. No.	4241
description	power contactor resistive load 20A 24VAC (AC3/400V) 9A/4kW main contacts 2NO auxiliary contacts 2NC connection screw connection type 11BG09T2A24		
For models:	AF55, AF61, AF61D, AF61DPS, AF61PS, AF61PSW, AF61W, AF78, AF78D, AF78DPS, AF78PS, AF78PSW, AF78W, AF88, AL07, AL07D, AL09, AL09D, AL10, AL11, AL15, AL16, AL20, AL20D, AL21, AL25, AL25D, AL26, AL30, AL31, AL35, AL36, AL40, AL40D, AL40PS, AL41, AL45, AL45D, AL45PS, AL46, AL54, AL54D, AL55, AL55D, AL55PS, ALP01, ALP01G, ALP02, ALP02G, ALP33...(Other models you can see in the webshop)		



1

Part No.	381186	Ref. No.	14123 14169
description	power contactor resistive load 40A 24VAC (AC3/400V) 20A/9.7kW main contacts 3NO auxiliary contacts connection screw connection type BF2000245060		
For models:	ALP02, ALP02G		



ALLEN BRADLEY

power contactors



1

Part No.	381187	Ref. No.	13114
description	power contactor resistive load 20A 24VAC (AC3/400V) 9A/4kW main contacts 3NO auxiliary contacts 1NO connection screw connection type 100-K09KJ10		
For models:	ALC100, ALP01, ALP02, ALP02E, ALP02EG, ALP02G, ATR100, ATR130, ATR160, ATR161, ATR190AED, ATR221, ATR311, ATR75, AZ75, AZ80, AZ90, AZ91		

relays

power relays

with flange mounting



1

Part No.	380130	Ref. No.	1075
description	power relays Italiana Relè 230VAC 16A 3NO connection male faston 6.3mm screw mounting manuf. no. B1-3-230AC		
For models:	AF55, AF61, AF610PSW, AF61D, AF61DPS, AF61EWP, AF61PS, AF61PSW, AF61W, AF78, AF780PSW, AF78D, AF78DPS, AF78EWP, AF78PS, AF78PSW, AF78W, AL03, AL05, AL05D, AL15, AL16, AL20, AL20D, AL25, AL25D, AL26, AL30, AL31, AL35, AL36, AL40, AL40D, AL40PS, AL41, AL45, AL45D, AL45PS, AL46, AL50, AL50PS, AL54, AL54D, AL55, AL55D, AL55PS, AL60, AL60PS, ALP01E, ALP01EG... (Other models you can see in the webshop)		

with bracket mounting

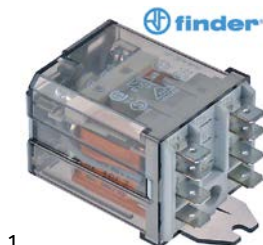

1

Part No.	380139	Ref. No.	6965
description	power relays FINDER 230VAC 16A 2CO connection F6.3 bracket mounting dimensions 68x38.2x35.8mm manuf. no. 62.82.8.230.0000		
For models:	KYRA1		

pulse relays



1

Part No.	380350	Ref. No.	7711
description	pulse relay 4NO 230V 10A		
For models:	AF61E, AF61ED, AF61EPS, AF61EW, AF61EWP, AF78E, AF78ED, AF78EDP, AF78EPS, AF78EW, AF78EWP, AF88E, AF88EP, AL40E, AL41E, AL45E, AL46E, ALP01E, ALP01EG, ALP02E, ALP02EG, ALP33E, ALP44, ALP44P, AT105E, AT110E, AT112, AT114, AT116		

time relays

time relays



1

Part No.	381188	Ref. No.	13124 4279
description	time relay ALLEN-BRADLEY 700-FEB1TU22 time range 0.05s-10h 24VAC/DC-110-240VAC 5A mounting measurementsmm 1NO connection screw		
For models:	ALC100, ATR161, ATR221, ATR311, ATR75		

transformers

open transformers

with clamp terminal



1

Part No.	403265	Ref. No.	4686
description	transformer primary 440VAC secondary 220VAC 250VA connection screw 60Hz		



electronic controllers

EVCO - EVERY CONTROL

electronic thermometers

built-in version



1

Part No.	378344	Ref. No.	14242
description	thermometer EVERY CONTROL type TM103AN2 mounting measurements 58x25.5mm 12V voltage AC/DC -40 up to +110°C measuring input NTC 10kOhm display 3 digits front measurements 64x32mm with probe		
For models:	ALP01, ALP01G, ALP02, ALP02G, ATR221, ATR311		

probes

universal probes

temperature probes



1

Part No.	379064	Ref. No.	7710 7723
description	temperature probe PTC 1kOhm cable silicone probe -50 up to +150°C cable -50 up to +180°C probe ø6x40mm cable length 3m without screw connection 2-wire		
For models:	AF610, AF610D, AF610PS, AF610PSW, AF610W, AF61E, AF61ED, AF61EPS, AF61EW, AF61EWP, AF780, AF780D, AF780PS, AF780PSW, AF780W, AF78E, AF78ED, AF78EDP, AF78EPS, AF78EW, AF78EWP, AF880, AF88E, AF88EP, AL402, AL40E, AL41E, AL45E, AL46E, ALP33E, ALP44, ALP44P, AT105E, AT110E, AT112, AT114, AT116, ATR100, ATR130, ATR130ED, ATR160, ATR190AED, KYRA1, KYRA2		

electronics

EPROMS



1

Part No.	400132	Ref. No.	7728
description	EPROM		
For models:	AL40E, AL41E, AL45E, AL46E		



1

Part No.	400133	Ref. No.	7722
description	EPROM		
For models:	AL40E, AL41E, AL45E, AL46E		

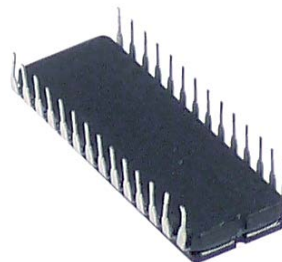

1

Part No.	400468	Ref. No.	7735
description	EPROM		
For models:	AF78E, AF78ED, AF78EDP, AF78EPS, AF88E, ALP33E		

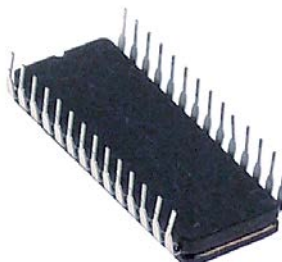

1

Part No.	400186	Ref. No.	7725 7731 7735/AF78E (inTedesco)
description	EPROM suitable for ALP language german		
For models:	ALP01E, ALP01EG, ALP02E, ALP02EG, ALP44, ALP44P		

1

Part No.	402800	Ref. No.	7735/AF78E (in Italiano)
description	EPROM suitable for ALP language Italian		



PCBs



1			
Part No.	400137	Ref. No.	7721
description	display		
For models:	AF78E, AF78ED, AF78EDP, AF78EPS, AF88E, AL40E, AL41E, AL45E, AL46E, ALP01E, ALP01EG, ALP02E, ALP02EG, ALP33E, ALP44, ALP44P		

1			
Part No.	400135	Ref. No.	7967
description	PCB		
For models:	AL40ET, AL45ET		

keypads

front foils

1			
Part No.	400465	Ref. No.	7714
description	keypad foil		
For models:	AF61E, AF61ED, AF61EPS, AF61EW, AF61EWP, AF78E, AF78ED, AF78EDP, AF78EPS, AF78EW, AF78EWP, AF88E, AF88EP, ALP33E		

1			
Part No.	400470	Ref. No.	9673
description	keypad foil		
For models:	AT105E, AT110E, AT112, AT114, AT116		

1			
Part No.	404011	Ref. No.	7713
description	keypad foil dishwasher AL40/41/45 L 450mm W 40mm		
For models:	AL40E, AL41E, AL45E, AL46E		

solenoid valves

solenoid valves (water)

ELBI			
angled			
1			
Part No.	370733	Ref. No.	13103
description	solenoid valve single angled 24VAC inlet 3/4" outlet 11.5mm DN10 ELBI plastic		
For models:	ALC100, ALP01, ALP01G, ALP02, ALP02E, ALP02G, ATR100, ATR130, ATR130ED, ATR160, ATR161, ATR190AED, ATR221, ATR311, ATR75, CF		
spare parts for	370733		
		Part No.	370467
		Ref. No.	—
	solenoid valve filter suitable for ELBI		

1			
Part No.	370734	Ref. No.	2504 4695
description	solenoid valve single angled 230VAC inlet 3/4" outlet 11.5mm t.max. 60°C ELBI 319 plastic flow regulating valve inlet black		
For models:	AF55, AF61, AF610, AF610PS, AF610PSW, AF610W, AF61E, AF61EPS, AF61EW, AF61EWP, AF61PS, AF61PSW, AF61W, AF73, AF73PS, AF78, AF780, AF780D, AF780PS, AF780PSW, AF780W, AF78E, AF78EPS, AF78EW, AF78EWP, AF78PS, AF78PSW, AF78W, AF83, AF88, AF880, AF88E, AF88EP, ALP01E, ALP01EG, ALP02E, ALP02EG, ALP33, ALP33E, ALP42, ALP42P, ALP44, ALP44P, AT105, AT1050, AT105E, AT106, AT110, AT110E, AT112...(Other models you can see in the webshop)		

TP			
1			
Part No.	370019	Ref. No.	1066 7214
description	solenoid valve double angled 230VAC inlet 3/4" outlet 11.5mm DN10 TP plastic		
For models:	AF61, AF610D, AF61D, AF61ED, AF61PS, AF78, AF780D, AF78D, AF78ED, AF78EDP, AF78PS, AL11, AL15, AL16, AL20D, AL21, AL25, AL25D, AL26, AL30, AL31, AL35, AL36, AL40, AL40D, AL40E, AL40ET, AL40PS, AL41, AL41E, AL45, AL45D, AL45E, AL45ET, AL45PS, AL46, AL46E, AL50, AL50PS, AL54D, AL55D, AL60, AL60PS, ALP44, AME540, AT116, KYRA1, KYRA2		
spare parts for	370019		
		Part No.	371013
		Ref. No.	—
	solenoid coil TP 230VAC 50/60Hz		

Table continues overleaf





accessories for		370019		
	Part No.	371220	Ref. No.	—
reducer TP flow rate 3l/min red tolerance ±15%				
	Part No.	371221	Ref. No.	—
reducer TP flow rate 5.5l/min yellow tolerance ±15%				
	Part No.	371222	Ref. No.	—
reducer TP flow rate 6l/min grey tolerance ±15%				
	Part No.	371223	Ref. No.	—
reducer TP flow rate 10l/min white tolerance ±15%				
	Part No.	371224	Ref. No.	—
reducer TP flow rate 12l/min bronze tolerance ±15%				
	Part No.	371225	Ref. No.	—
reducer TP flow rate 16l/min light brown tolerance ±15%				
	Part No.	371226	Ref. No.	—
reducer TP flow rate 20l/min red tolerance ±15%				
	Part No.	371230	Ref. No.	—
reducer TP flow rate 0.25l/min red tolerance ±25%				
	Part No.	371231	Ref. No.	—
reducer TP flow rate 0.35l/min violet tolerance ±25%				
	Part No.	371232	Ref. No.	—
reducer TP flow rate 0.5l/min orange tolerance ±25%				
	Part No.	371233	Ref. No.	—
reducer TP flow rate 0.8l/min white tolerance ±25%				
	Part No.	371234	Ref. No.	—
reducer TP flow rate 1l/min light blue tolerance ±25%				
	Part No.	371235	Ref. No.	—
reducer TP flow rate 1.2l/min brown tolerance ±25%				
	Part No.	371236	Ref. No.	—
reducer TP flow rate 1.5l/min light brown tolerance ±25%				
	Part No.	371237	Ref. No.	—
reducer TP flow rate 2.5l/min yellow tolerance ±25%				
	Part No.	371238	Ref. No.	—
reducer TP flow rate 3.4l/min dark green tolerance ±25%				
	Part No.	371239	Ref. No.	—
reducer TP flow rate 5l/min black tolerance ±25%				
	Part No.	371240	Ref. No.	—
reducer TP flow rate 8l/min blue tolerance ±20%				

			
1			
Part No.	370110	Ref. No.	14131
description	solenoid valve double angled 24VAC inlet 3/4" outlet 14mm DN10 TP		
For models:	ALP01, ALP02		
spare parts for	370110		
	Part No.	371035	Ref. No.
solenoid coil 24VAC			
accessories for	370110		
	Part No.	371220	Ref. No.
reducer TP flow rate 3l/min red tolerance ±15%			
	Part No.	371221	Ref. No.
reducer TP flow rate 5.5l/min yellow tolerance ±15%			
	Part No.	371222	Ref. No.
reducer TP flow rate 6l/min grey tolerance ±15%			
	Part No.	371223	Ref. No.
reducer TP flow rate 10l/min white tolerance ±15%			
	Part No.	371224	Ref. No.
reducer TP flow rate 12l/min bronze tolerance ±15%			
	Part No.	371225	Ref. No.
reducer TP flow rate 16l/min light brown tolerance ±15%			
	Part No.	371226	Ref. No.
reducer TP flow rate 20l/min red tolerance ±15%			
	Part No.	371230	Ref. No.
reducer TP flow rate 0.25l/min red tolerance ±25%			
	Part No.	371231	Ref. No.
reducer TP flow rate 0.35l/min violet tolerance ±25%			
	Part No.	371232	Ref. No.
reducer TP flow rate 0.5l/min orange tolerance ±25%			
	Part No.	371233	Ref. No.
reducer TP flow rate 0.8l/min white tolerance ±25%			
	Part No.	371234	Ref. No.
reducer TP flow rate 1l/min light blue tolerance ±25%			
	Part No.	371235	Ref. No.
reducer TP flow rate 1.2l/min brown tolerance ±25%			
	Part No.	371236	Ref. No.
reducer TP flow rate 1.5l/min light brown tolerance ±25%			
	Part No.	371237	Ref. No.
reducer TP flow rate 2.5l/min yellow tolerance ±25%			

Table continues overleaf







accessories for		370110		
Part No.		371238	Ref. No.	—
	reducer TP flow rate 3.4l/min dark green tolerance ±25%			
	reducer TP flow rate 5l/min black tolerance ±25%			
	reducer TP flow rate 8l/min blue tolerance ±20%			



1

Part No.	370015	Ref. No.	7604
description	solenoid valve single angled 230VAC inlet 3/4" outlet 11.5mm DN10 TP		
For models:	AL03, AL07, AL10, AL20, AL54, AL55, AL55PS, KYRA1WAG		
accessories for		370015	
	reducer TP flow rate 3l/min red tolerance ±15%		
	reducer TP flow rate 5.5l/min yellow tolerance ±15%		
	reducer TP flow rate 6l/min grey tolerance ±15%		
	reducer TP flow rate 10l/min white tolerance ±15%		
	reducer TP flow rate 12l/min bronze tolerance ±15%		
	reducer TP flow rate 16l/min light brown tolerance ±15%		
	reducer TP flow rate 20l/min red tolerance ±15%		
	reducer TP flow rate 0.25l/min red tolerance ±25%		
	reducer TP flow rate 0.35l/min violet tolerance ±25%		
	reducer TP flow rate 0.5l/min orange tolerance ±25%		
	reducer TP flow rate 0.8l/min white tolerance ±25%		
	reducer TP flow rate 1l/min light blue tolerance ±25%		
	reducer TP flow rate 1.2l/min brown tolerance ±25%		

accessories for		370015		
Part No.		371236	Ref. No.	—
	reducer TP flow rate 1.5l/min light brown tolerance ±25%			
	reducer TP flow rate 2.5l/min yellow tolerance ±25%			
	reducer TP flow rate 3.4l/min dark green tolerance ±25%			
	reducer TP flow rate 5l/min black tolerance ±25%			
	reducer TP flow rate 8l/min blue tolerance ±20%			



1

Part No.	370138	Ref. No.	7209
description	solenoid valve triple angled 230VAC inlet 3/4" ET outlet 11.5mm plastic		
For models:	AF61D, AF61DPS, AF78D, AF78DPS, AL16, AL26, AL31, AL36, AL41, AL41E, AL46, AL46E		

metal

SIRAI

2-way

L180-B series



1

Part No.	370391	Ref. No.	14130
description	solenoid valve 2-ways 24VAC connection 3/4" L 79mm DN 18mm -10 up to +90°C coil type Z610A membranes NBR (water) p max 12bar p min 0.35bar		
For models:	ALP01, ALP02		
accessories for		370391	
	power socket plug type DIN 43650B cable lengthmm small		



drain valves

 <p>1</p>			
Part No.	371107	Ref. No.	13102
description	drain valve 24V 50/60Hz single inlet 50mm outlet 50mm		
For models:	ALC100, ALP01, ALP01G, ALP02, ALP02G, ATR100, ATR130, ATR130ED, ATR160, ATR161, ATR190AED, ATR221, ATR311		

pressure switches

for warewashing

ø 58mm with male faston 6.3mm

with connection horizontal

 <p>1</p>			
Part No.	541846	Ref. No.	4646
description	bracket for pressure switch H 20mm L 44mm W 12mm		

 <p>1</p>			
Part No.	541142	Ref. No.	9830
description	pressure control pressure range 123/75mbar connection 6mm ø 58mm pressure connection horizontal warewashing		
For models:	AF61, AF61D, AF61DPS, AF61PS, AF61PSW, AF61W, AF78, AF78D, AF78DPS, AF78E, AF78ED, AF78EDP, AF78EPS, AF78PS, AF88, AF88E, ALC100, ALP01, ALP01E, ALP01EG, ALP01G, ALP02, ALP02E, ALP02EG, ALP02G, ALP33, ALP33E, ALP42, ALP42P, ALP44, ALP44P, AME540, AT105, AT105E, AT110, AT110E, AT112, AT114, AT116, AT95, ATR161, ATR221, ATR311, ATR75		

 <p>1</p>			
Part No.	541132	Ref. No.	6850 6854
description	pressure control pressure range 40/18mbar connection 6mm ø 58mm pressure connection horizontal warewashing		
For models:	AL10, AL11, AL15, AL16, AL20, AL20D, AL25, AL25D, AL40, AL402, AL40D, AL40E, AL40PS, AL41E, AL45, AL45D, AL45E, AL45PS, AL46E, KYRA1, KYRA1WAG		

 <p>1</p>			
Part No.	541140	Ref. No.	1004
description	pressure control pressure range 55/30mbar connection 6mm ø 58mm pressure connection horizontal warewashing		
For models:	AF55, AL07, AL07D, AL09, AL09D, AL10, AL11, AL15, AL16, AL20, AL21, AL25, AL26, AL30, AL31, AL35, AL36, AL40, AL40E, AL40PS, AL41, AL41E, AL45, AL45E, AL45PS, AL46, AL46E, AL54, AL54D, AL55, AL55D, AL55PS, ALP01, ALP01E, ALP01EG, ALP01G, ALP02, ALP02E, ALP02EG, ALP02G, AT105, AT105D, AT105E, AT110, AT110E, AT116, AT900, AT95, KYRA1, KYRA2		

 <p>1</p>			
Part No.	541141	Ref. No.	4210
description	pressure control pressure range 75/35mbar connection 6mm ø 58mm pressure connection horizontal warewashing pressure connection ø 6mm		
For models:	AF73, AF73PS, AF78, AF78PS, AF83, AF88, AL03, AL05, AL05D, AL50, AL50PS, AL60, AL60PS, AT105, AT106		

 <p>1</p>			
Part No.	541959	Ref. No.	9833
description	pressure control pressure range 90/30mbar connection 6mm ø 58mm pressure connection horizontal warewashing pressure connection ø 6mm		
For models:	AF61, AF610, AF610D, AF610PS, AF610PSW, AF610W, AF61D, AF61DPS, AF61E, AF61ED, AF61EPS, AF61EW, AF61EWP, AF61PS, AF61PSW, AF61W, AF78, AF780, AF780D, AF780PS, AF780PSW, AF780W, AF78D, AF78DPS, AF78E, AF78ED, AF78EDP, AF78EPS, AF78EW, AF78EWP, AF78PS, AF78PSW, AF78W		

electrodes

 <p>1</p>			
Part No.	516174	Ref. No.	5672
description	level electrode		
For models:	AF55, AF61, AF610, AF610D, AF610PS, AF610PSW, AF610W, AF61D, AF61DPS, AF61PS, AF61PSW, AF61W, AF78, AF780, AF780D, AF780PS, AF780PSW, AF780W, AF78D, AF78DPS, AF78PS, AF78PSW, AF78W, AF88, AF880, AL07, AL07D, AL09, AL09D, AL10, AL11, AL15, AL16, AL20, AL20D, AL21, AL25, AL25D, AL26, AL30, AL31, AL35, AL36, AL40, AL402, AL40D, AL40PS, AL41, AL45, AL45D...(Other models you can see in the webshop)		



motors

gear motors

for dishwashers



Part No.	500194	Ref. No.	9620
description	gear motor 130/160W 230/400V 50/60Hz 3 phase shaft ø 25mm L 650mm W 150mm H 230mm for dishwasher		
For models:	AT112, AT114, AT116		

pumps

wash and rinse pumps

ALBA (C&A)





pumps







Part No.	500182	Ref. No.	7955
description	pump		
For models:	AL30, AL35, AL40, AL40ET, AL45, AL45ET		



Part No.	500180	Ref. No.	7650 7670
description	pump inlet ø 28mm outlet ø 28mm type C7670 230V 50Hz 1 phase 0.11kW 0.15HP L 190mm rotation direction right capacitor 6.3µF ALBA PUMPS (C&A)		
For models:	AL03, AL05, AL05D, AL10, AL11, AL15, AL16		
spare parts for	500180		
	Part No.	365012	Ref. No. —
	operating capacitor capacity 6.3µF 450V tolerance 5% 50Hz ambient temperature max. -25 to +85°C ø 30mm L 61mm M8 plastic connection male faston 6.3mm protection		





spare parts for	500180		
	Part No.	510692	Ref. No. 4703 7677
	mechanical shaft seal for shaft ø 11mm slide ring ext. ø 24mm slide ring H 13mm counter ring mounting ø 26mm height counter ring 8mm counter ring int. ø 14mm		
	Part No.	521222	Ref. No. 7678
	impeller ø 72mm H 19mm thread M7L shaft ø 11mm shaft length 29mm blades 3		
	Part No.	521518	Ref. No. 7679
	pump cover ALBA PUMPS (C&A) inlet ø 28mm outlet ø 28mm turn direction right ø 93mm ID ø 76mm inner height 31mm		
	Part No.	532490	Ref. No. 7676
	O-ring EPDM thickness 2.62mm ID ø 72.69mm Qty 1 pcs		



Part No.	500032	Ref. No.	7207
description	pump inlet ø 45mm outlet ø 40mm type C430 230V 50Hz 1 phase 0.35kW 0.5HP L 260mm rotation direction right capacitor 10µF ALBA PUMPS (C&A)		
For models:	AL30, AL31, AL35, AL36, AL40, AL41, AL45, AL46		
spare parts for	500032		
	Part No.	365015	Ref. No. —
	operating capacitor capacity 10µF 400V tolerance 5%Hz ambient temperature max. -25 to +85°C ø 35.5mm L 59mm M8 plastic connection male faston 6.3mm protection		
	Part No.	509018	Ref. No. 7683
	O-ring EPDM thickness 3.53mm ID ø 107.5mm Qty 1 pcs		
	Part No.	509028	Ref. No. 7685
	impeller ø 87mm H 21mm rotation direction right thread M7L shaft ø 12mm		
	Part No.	510693	Ref. No. 7252 oder 7253 7681/4984 7684
	mechanical shaft seal for shaft ø 12mm slide ring ext. ø 24mm slide ring H 15.5mm slide ring int. ø 11mm counter ring mounting ø 24mm height counter ring 8mm counter ring int. ø 13.5mm		
	Part No.	521528	Ref. No. 7686
	pump cover ALBA PUMPS (C&A) inlet ø 45mm outlet ø 40mm turn direction right ø 129mm ID ø 105mm inner height 19mm		







1





Part No.	500188	Ref. No.	7274
description	pump inlet ø 45mm outlet ø 40mm type C7274 230V 1 phase 0.37kW 0.5HP L 215mm rotation direction right capacitor 10µF auxiliary pressure connection 18mm supporting pressure closed ALBA PUMPS (C&A)		
For models:	AL30, AL35, AL40, AL40E, AL40PS, AL41E, AL45, AL45E, AL45PS, AL46E		
spare parts for	500188		
	Part No.	365015	Ref. No. —
	operating capacitor capacity 10µF 400V tolerance 5%Hz ambient temperature max. -25 to +85°C ø 35.5mm L 59mm M8 plastic connection male faston 6.3mm protection		
	Part No.	509014	Ref. No. 7254
	O-ring EPDM thickness 1.78mm ID ø 107.67mm Qty 1 pcs		
	Part No.	509028	Ref. No. 7685
	impellor ø 87mm H 21mm rotation direction right thread M7L shaft ø 12mm		
	Part No.	510693	Ref. No. 7252 oder 7253 7681/4984 7684
	mechanical shaft seal for shaft ø 12mm slide ring ext. ø 24mm slide ring H 15.5mm slide ring int. ø 11mm counter ring mounting ø 24mm height counter ring 8mm counter ring int. ø 13.5mm		
	Part No.	521541	Ref. No. 7250
	pump cover ALBA PUMPS (C&A) inlet ø 45mm outlet ø 40mm auxiliary pressure connection 18mm supporting pressure closed turn direction right ø 140mm ID ø 110mm inner height 30mm		









1







Part No.	500189	Ref. No.	7279
description	pump inlet ø 45mm outlet ø 40mm type C7279 230V 1 phase 0.37kW 0.5HP L 215mm rotation direction right capacitor 10µF ALBA PUMPS (C&A)		
For models:	AL41E, AL46E		
spare parts for	500189		
	Part No.	365015	Ref. No. —
	operating capacitor capacity 10µF 400V tolerance 5%Hz ambient temperature max. -25 to +85°C ø 35.5mm L 59mm M8 plastic connection male faston 6.3mm protection		
	Part No.	509014	Ref. No. 7254
	O-ring EPDM thickness 1.78mm ID ø 107.67mm Qty 1 pcs		
	Part No.	509028	Ref. No. 7685
	impellor ø 87mm H 21mm rotation direction right thread M7L shaft ø 12mm		
	Part No.	510693	Ref. No. 7252 oder 7253 7681/4984 7684
	mechanical shaft seal for shaft ø 12mm slide ring ext. ø 24mm slide ring H 15.5mm slide ring int. ø 11mm counter ring mounting ø 24mm height counter ring 8mm counter ring int. ø 13.5mm		
	Part No.	521541	Ref. No. 7250
	pump cover ALBA PUMPS (C&A) inlet ø 45mm outlet ø 40mm auxiliary pressure connection 18mm supporting pressure closed turn direction right ø 140mm ID ø 110mm inner height 30mm		



			
1			
Part No.	500577	Ref. No.	7286
description	pump inlet \varnothing 45mm outlet \varnothing 40mm type C7286 230V 50Hz 1 phase 0.37kW 0.5HP L 215mm rotation direction right capacitor 10 μ F auxiliary pressure connection 18mm supporting pressure open ALBA PUMPS (C&A)		
For models:	AL41E, AL46E		
spare parts for	500577		
	Part No.	509014	Ref. No. 7254
	O-ring EPDM thickness 1.78mm ID \varnothing 107.67mm Qty 1 pcs		
	Part No.	510693	Ref. No. 7252 oder 7253 7681/4984 7684
	mechanical shaft seal for shaft \varnothing 12mm slide ring ext. \varnothing 24mm slide ring H 15.5mm slide ring int. \varnothing 11mm counter ring mounting \varnothing 24mm height counter ring 8mm counter ring int. \varnothing 13.5mm		
	Part No.	521560	Ref. No. 7233
	pump cover ALBA PUMPS (C&A) inlet \varnothing 45mm outlet \varnothing 40mm auxiliary pressure connection 18mm supporting pressure open turn direction right \varnothing 140mm ID \varnothing 110mm inner height 30mm		
accessories for	500577		
	Part No.	365015	Ref. No. —
	operating capacitor capacity 10 μ F 400V tolerance 5%Hz ambient temperature max. -25 to +85°C \varnothing 35.5mm L 59mm M8 plastic connection male faston 6.3mm protection		

			
1			
Part No.	500181	Ref. No.	7655 7675
description	pump inlet \varnothing 45mm outlet \varnothing 40mm type C7675 230V 50Hz 1 phase 0.29kW 0.4HP L 175mm rotation direction right capacitor 10 μ F ALBA PUMPS (C&A)		
For models:	AL07, AL07D, AL09, AL09D, AL10, AL20, AL20D, AL21, AL25, AL25D, AL26, AL40, AL40D, AL40E, AL40PS, AL45, AL45D, AL45E, AL45PS		
spare parts for	500181		
	Part No.	365015	Ref. No. —
	operating capacitor capacity 10 μ F 400V tolerance 5%Hz ambient temperature max. -25 to +85°C \varnothing 35.5mm L 59mm M8 plastic connection male faston 6.3mm protection		

spare parts for	500181		
	Part No.	509018	Ref. No. 7683
	O-ring EPDM thickness 3.53mm ID \varnothing 107.5mm Qty 1 pcs		
	Part No.	509028	Ref. No. 7685
	impeller \varnothing 87mm H 21mm rotation direction right thread M7L shaft \varnothing 12mm		
	Part No.	510693	Ref. No. 7252 oder 7253 7681/4984 7684
	mechanical shaft seal for shaft \varnothing 12mm slide ring ext. \varnothing 24mm slide ring H 15.5mm slide ring int. \varnothing 11mm counter ring mounting \varnothing 24mm height counter ring 8mm counter ring int. \varnothing 13.5mm		
	Part No.	521528	Ref. No. 7686
	pump cover ALBA PUMPS (C&A) inlet \varnothing 45mm outlet \varnothing 40mm turn direction right \varnothing 129mm ID \varnothing 105mm inner height 19mm		

			
1			
Part No.	500184	Ref. No.	4683
description	pump inlet \varnothing 50mm outlet \varnothing 40mm type C4683 230V 50Hz 1 phase 0.55kW 0.75HP L 260mm rotation direction right capacitor 12.5 μ F ALBA PUMPS (C&A)		
For models:	AF73, AF73PS, AF78, AF78PS, AL50, AL50PS, AL60, AL60PS		
spare parts for	500184		
	Part No.	365014	Ref. No. —
	operating capacitor capacity 12.5 μ F 450V tolerance 5%Hz ambient temperature max. -25 to +85°C \varnothing 35mm L 70mm M8 plastic connection male faston 6.3mm 45S.C3DS.12.5 protection		
	Part No.	509021	Ref. No. 4702
	impeller \varnothing 102mm H 32mm shaft intake \varnothing 9/8mm rotation direction right		
	Part No.	510692	Ref. No. 4703 7677
	mechanical shaft seal for shaft \varnothing 11mm slide ring ext. \varnothing 24mm slide ring H 13mm counter ring mounting \varnothing 26mm height counter ring 8mm counter ring int. \varnothing 14mm		
	Part No.	521530	Ref. No. 4701
	pump cover ALBA PUMPS (C&A) inlet \varnothing 50mm outlet \varnothing 40mm pump type C.4710/C.4757/C.4683 turn direction right \varnothing 153mm ID \varnothing 127mm inner height 24mm		
	Part No.	521709	Ref. No. 4704
	O-ring EPDM thickness 3mm ID \varnothing 126mm Qty 1 pcs		



1

Part No.	500190	Ref. No.	4710
description	pump inlet ø 50mm outlet ø 40mm type C4710 230V 50Hz 1 phase 0.55kW 0.75HP L 240mm rotation direction right capacitor 12.5µF ALBA PUMPS (C&A)		
For models:	AF61, AF610, AF610D, AF610PS, AF610PSW, AF610W, AF61D, AF61DPS, AF61E, AF61ED, AF61EPS, AF61EW, AF61EWP, AF61PS, AF61PSW, AF61W, AF78, AF780, AF780D, AF780PS, AF780PSW, AF780W, AF78D, AF78DPS, AF78E, AF78ED, AF78EDP, AF78EPS, AF78EW, AF78EWP, AF78PS, AF78PSW, AF78W, AME540		
spare parts for	500190		
	Part No.	365014	Ref. No. —
	operating capacitor capacity 12.5µF 450V tolerance 5%Hz ambient temperature max. -25 to +85°C ø 35mm L 70mm M8 plastic connection male faston 6.3mm 45S.C3DS.12.5 protection		
	Part No.	509021	Ref. No. 4702
	impellor ø 102mm H 32mm shaft intake ø 9/8mm rotation direction right		
	Part No.	510693	Ref. No. 7252 oder 7253 7681/4984 7684
	mechanical shaft seal for shaft ø 12mm slide ring ext. ø 24mm slide ring H 15.5mm slide ring int. ø 11mm counter ring mounting ø 24mm height counter ring 8mm counter ring int. ø 13.5mm		
	Part No.	521530	Ref. No. 4701
	pump cover ALBA PUMPS (C&A) inlet ø 50mm outlet ø 40mm pump type C.4710/C.4757/C.4683 turn direction right ø 153mm ID ø 127mm inner hight 24mm		
	Part No.	521709	Ref. No. 4704
	O-ring EPDM thickness 3mm ID ø 126mm Qty 1 pcs		







1

Part No.	500192	Ref. No.	4715 8203
description	pump inlet ø 50mm outlet ø 40mm type C4715 230V 50Hz 1 phase 0.55kW 0.75HP L 240mm rotation direction right capacitor 12.5µF ALBA PUMPS (C&A)		
For models:	AF55, AL54, AL54D, AL55, AL55D, AL55PS		
spare parts for	500192		
	Part No.	365014	Ref. No. —
	operating capacitor capacity 12.5µF 450V tolerance 5%Hz ambient temperature max. -25 to +85°C ø 35mm L 70mm M8 plastic connection male faston 6.3mm 45S.C3DS.12.5 protection		
	Part No.	509021	Ref. No. 4702
	impellor ø 102mm H 32mm shaft intake ø 9/8mm rotation direction right		
	Part No.	510693	Ref. No. 7252 oder 7253 7681/4984 7684
	mechanical shaft seal for shaft ø 12mm slide ring ext. ø 24mm slide ring H 15.5mm slide ring int. ø 11mm counter ring mounting ø 24mm height counter ring 8mm counter ring int. ø 13.5mm		
	Part No.	521530	Ref. No. 4701
	pump cover ALBA PUMPS (C&A) inlet ø 50mm outlet ø 40mm pump type C.4710/C.4757/C.4683 turn direction right ø 153mm ID ø 127mm inner hight 24mm		
	Part No.	521709	Ref. No. 4704
	O-ring EPDM thickness 3mm ID ø 126mm Qty 1 pcs		







1

Part No.	500191	Ref. No.	4757
description	pump inlet \varnothing 50mm outlet \varnothing 40mm type C4757 400V 50Hz 3 phase 0.74kW 1HP L 255mm rotation direction right ALBA PUMPS (C&A)		
For models:	AF88, AF880, AF88E, AF88EP		
spare parts for	500191		
	Part No.	509021	Ref. No. 4702
	impellor \varnothing 102mm H 32mm shaft intake \varnothing 9/8mm rotation direction right		
	Part No.	510692	Ref. No. 4703 7677
	mechanical shaft seal for shaft \varnothing 11mm slide ring ext. \varnothing 24mm slide ring H 13mm counter ring mounting \varnothing 26mm height counter ring 8mm counter ring int. \varnothing 14mm		
	Part No.	521530	Ref. No. 4701
	pump cover ALBA PUMPS (C&A) inlet \varnothing 50mm outlet \varnothing 40mm pump type C.4710/C.4757/C.4683 turn direction right \varnothing 153mm ID \varnothing 127mm inner height 24mm		
	Part No.	521709	Ref. No. 4704
	O-ring EPDM thickness 3mm ID \varnothing 126mm Qty 1 pcs		







1

Part No.	500013	Ref. No.	6650
description	pump inlet \varnothing 50mm outlet \varnothing 48mm type C4100 400V 50Hz 3 phase 1.1kW 1.5HP L 325mm rotation direction right ALBA PUMPS (C&A)		
For models:	AT95, ATR311		
spare parts for	500013		
	Part No.	510551	Ref. No. 6633
	pump cover gasket ID \varnothing 158.3mm pump type 1214/1293/1225/2243/1226/1204/3473/1241 thickness 3.53mm EPDM Qty 1 pcs		

spare parts for	500013		
	Part No.	510620	Ref. No. 14115
	impellor \varnothing 109mm H 27mm rotation direction right thread M8L blades 6		
	Part No.	510693	Ref. No. 7252 oder 7253 7681/4984 7684
	mechanical shaft seal for shaft \varnothing 12mm slide ring ext. \varnothing 24mm slide ring H 15.5mm slide ring int. \varnothing 11mm counter ring mounting \varnothing 24mm height counter ring 8mm counter ring int. \varnothing 13.5mm		
	Part No.	521535	Ref. No. 6631
	pump cover inlet \varnothing 50mm outlet \varnothing 48mm turn direction right \varnothing 180mm ID \varnothing 150mm inner height 38mm		





1

Part No.	500185	Ref. No.	4630 4630 1-phasig!!!!
description	pump inlet \varnothing 50mm outlet \varnothing 48mm type C4630 230V 50Hz 1 phase 0.74kW 1HP L 325mm rotation direction right capacitor 16 μ F ALBA PUMPS (C&A)		
For models:	AF73, AF73PS, AF78, AF78PS, AL50, AL50PS, AL60, AL60PS		
spare parts for	500185		
	Part No.	365021	Ref. No. —
	operating capacitor capacity 16 μ F 425V tolerance 5% 50/60Hz ambient temperature max. -25 to +85°C \varnothing 35mm L 73mm single M8 plastic connection male faston 6.3mm 416.10.99 protection		
	Part No.	510692	Ref. No. 4703 7677
	mechanical shaft seal for shaft \varnothing 11mm slide ring ext. \varnothing 24mm slide ring H 13mm counter ring mounting \varnothing 26mm height counter ring 8mm counter ring int. \varnothing 14mm		
	Part No.	521238	Ref. No. —
	impellor \varnothing 103mm H 32mm rotation direction right thread M7L seat \varnothing 9.2mm blades 6		
	Part No.	521709	Ref. No. 4704
	O-ring EPDM thickness 3mm ID \varnothing 126mm Qty 1 pcs		





1

Part No.	500198	Ref. No.	5630 5630 3-phasig
description	pump inlet ø 50mm outlet ø 48mm type C5630 230/400V 50Hz 3 phase 0.74kW 1HP L 305mm rotation direction right ALBA PUMPS (C&A)		
For models:	AF83, AF88		
spare parts for	500198		
	Part No.	503125	Ref. No. 4633
	pump cover gasket EPDM thickness 3mm ID ø 129mm Qty 1 pcs		
	Part No.	510692	Ref. No. 4703 7677
	mechanical shaft seal for shaft ø 11mm slide ringext. ø 24mm slide ring H 13mm counter ring mounting ø 26mm height counter ring 8mm counter ring int. ø 14mm		
	Part No.	521238	Ref. No. —
	impellor ø 103mm H 32mm rotation direction right thread M7L seat ø 9.2mm blades 6		







1

Part No.	500272	Ref. No.	6600
description	pump inlet ø 50mm outlet ø 48mm type C6600 230/400V 50Hz 3 phase 0.89kW 1.2HP L 300mm rotation direction right ALBA PUMPS (C&A)		
For models:	AT105, AT106, AT95		
spare parts for	500272		
	Part No.	503125	Ref. No. 4633
	pump cover gasket EPDM thickness 3mm ID ø 129mm Qty 1 pcs		
	Part No.	510692	Ref. No. 4703 7677
	mechanical shaft seal for shaft ø 11mm slide ringext. ø 24mm slide ring H 13mm counter ring mounting ø 26mm height counter ring 8mm counter ring int. ø 14mm		

spare parts for	500272		
	Part No.	521238	Ref. No. —
	impellor ø 103mm H 32mm rotation direction right thread M7L seat ø 9.2mm blades 6		







1

Part No.	500186	Ref. No.	8212 9808
description	pump inlet ø 62mm outlet ø 62mm type C9808 230/400V 50Hz 3 phase 1.1kW 1.5HP L 355mm rotation direction right auxiliary pressure connection 12mm supporting pressure closed ALBA PUMPS (C&A)		
For models:	ALC100, AT112, AT95, ATR311		
spare parts for	500186		
	Part No.	510551	Ref. No. 6633
	pump cover gasket ID ø 158.3mm pump type 1214/1293/1225/2243/1226/1204/3473/1241 thickness 3.53mm EPDM Qty 1 pcs		
	Part No.	510620	Ref. No. 14115
	impellor ø 109mm H 27mm rotation direction right thread M8L blades 6		
	Part No.	510693	Ref. No. 7252 oder 7253 7681/4984 7684
	mechanical shaft seal for shaft ø 12mm slide ringext. ø 24mm slide ring H 15.5mm slide ring int. ø 11mm counter ring mounting ø 24mm height counter ring 8mm counter ring int. ø 13.5mm		
	Part No.	521537	Ref. No. 14101
	pump cover inlet ø 62mm outlet ø 62mm auxiliary pressure connection 12mm supporting pressure closed turn direction right ø 180mm ID ø 150mm inner height 38mm		



1

Part No.	500187	Ref. No.	9805 9806
description	pump inlet \varnothing 63mm outlet \varnothing 61mm type C9806 230/400V 50Hz 3 phase 1.5kW 2HP L 330mm rotation direction right auxiliary pressure connection 12mm supporting pressure closed ALBA PUMPS (C&A)		
For models:	ALP01, ALP01E, ALP01EG, ALP01G, ALP33, ALP42, ALP42P, ALP44, ALP44P, AT105, AT110, AT114, AT116		
spare parts for	500187		
	Part No.	510551	Ref. No. 6633
	pump cover gasket ID \varnothing 158.3mm pump type 1214/1293/1225/2243/1226/1204/3473/1241 thickness 3.53mm EPDM Qty 1 pcs		
	Part No.	510620	Ref. No. 14115
	impellor \varnothing 109mm H 27mm rotation direction right thread M8L blades 6		
	Part No.	510693	Ref. No. 7252 oder 7253 7681/4984 7684
	mechanical shaft seal for shaft \varnothing 12mm slide ring ext. \varnothing 24mm slide ring H 15.5mm slide ring int. \varnothing 11mm counter ring mounting \varnothing 24mm height counter ring 8mm counter ring int. \varnothing 13.5mm		
	Part No.	521537	Ref. No. 14101
	pump cover inlet \varnothing 62mm outlet \varnothing 62mm auxiliary pressure connection 12mm supporting pressure closed turn direction right \varnothing 180mm ID \varnothing 150mm inner hight 38mm		





LGB

1

Part No.	499070	Ref. No.	4710/P 8201/230V/60Hz/0,62kW
description	pump 230V 60Hz 0.62kW		



1

Part No.	500599	Ref. No.	1511
description	pump inlet \varnothing 28mm outlet \varnothing 12mm type ZF131DX 230V 50Hz 1 phase 0.16kW 0.22HP L 175mm rotation direction left capacitor 6.3 μ F LGB		
For models:	AF610PSW, AF610W, AF61EW, AF61EWP, AF61PSW, AF61W, AF780PSW, AF780W, AF78EW, AF78EWP, AF78PSW, AF78W, AT105, AT105E, AT110, AT110E, AT116, AT95		
spare parts for	500599		
	Part No.	365012	Ref. No. —
	operating capacitor capacity 6.3 μ F 450V tolerance 5% 50Hz ambient temperature max. -25 to +85°C \varnothing 30mm L 61mm M8 plastic connection male faston 6.3mm protection		
	Part No.	510703	Ref. No. —
	mechanical shaft seal for shaft \varnothing 13mm slide ring H 13mm height counter ring 5.5mm ED \varnothing 26mm		
	Part No.	521119	Ref. No. 1528
	pump cover LGB inlet \varnothing 28mm outlet \varnothing 12mm auxiliary pressure connection 12mm pump type ZF131DX		
	Part No.	521228	Ref. No. —
	impellor \varnothing 72mm H 17mm rotation direction left thread M7R shaft \varnothing 13mm shaft length 12mm blades 3		
	Part No.	528800	Ref. No. —
	O-ring EPDM thickness 2.62mm ID \varnothing 75.87mm Qty 1 pcs		

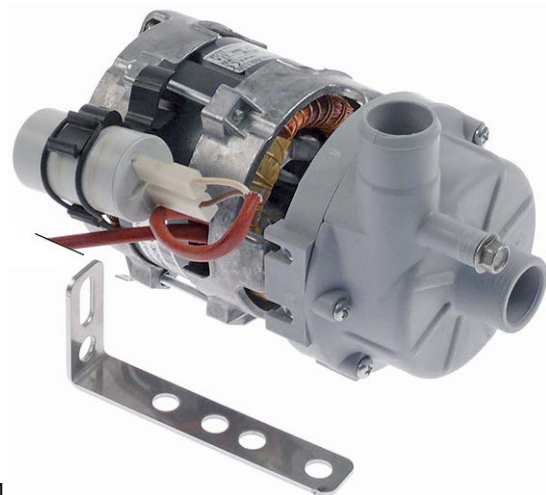

1





Part No.	500936	Ref. No.	8204
description	pump inlet \varnothing 28mm outlet \varnothing 26mm type ZF119SX 230V 50Hz 1 phase 0.24kW 0.33HP L 190mm rotation direction right capacitor 5 μ F LGB		
spare parts for	500936		
	Part No.	365017	Ref. No. —
	operating capacitor capacity 5 μ F 450V tolerance 5% 50/60Hz ambient temperature max. -25 to +85°C \varnothing 28mm L 54mm M8 plastic connection male faston 6.3mm 16.10.08 protection		

Table continues overleaf





spare parts for 500936			
	Part No.	521057	Ref. No. —
	pump cover LGB inlet \varnothing 28mm outlet \varnothing 26mm auxiliary pressure connection 12mm supporting pressure open turn direction right \varnothing 102mm ID \varnothing 77mm inner height 31mm		
	Part No.	528800	Ref. No. —
	O-ring EPDM thickness 2.62mm ID \varnothing 75.87mm Qty 1 pcs		
accessories for 500936			
	Part No.	550964	Ref. No. 7556
	fastening angle for pump		



Part No.	500942	Ref. No.	8209
description	pump inlet \varnothing 45mm outlet \varnothing 40mm type ZF150SX 230V 50Hz 1 phase 0.34kW 0.5HP L 180mm rotation direction right capacitor 10 μ F LGB		



Part No.	500937	Ref. No.	8207
description	pump inlet \varnothing 45mm outlet \varnothing 40mm type ZF150SX 230V 50Hz 1 phase 0.36kW 0.48HP L 180mm rotation direction right capacitor 10 μ F auxiliary pressure connection 13mm supporting pressure open LGB		
For models:	AL402		

spare parts for 500937			
	Part No.	365015	Ref. No. —
	operating capacitor capacity 10 μ F 400V tolerance 5%Hz ambient temperature max. -25 to +85°C \varnothing 35.5mm L 59mm M8 plastic connection male faston 6.3mm protection		
	Part No.	510703	Ref. No. —
	mechanical shaft seal for shaft \varnothing 13mm slide ring H 13mm height counter ring 5.5mm ED \varnothing 26mm		

spare parts for 500937			
	Part No.	521701	Ref. No. —
	pump cover gasket		





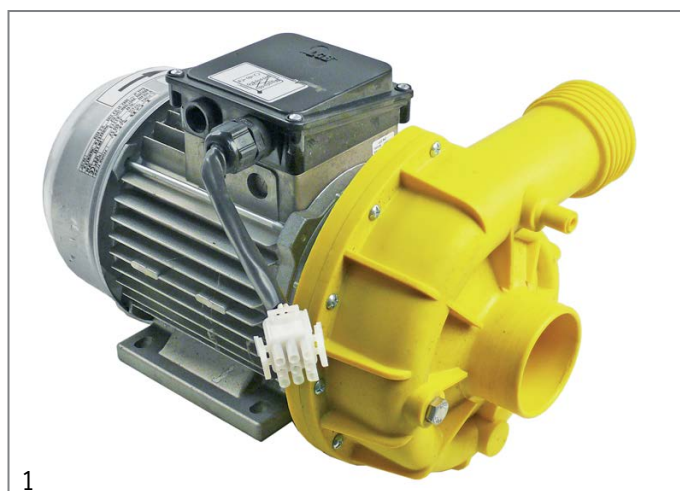

Part No.	500924	Ref. No.	4710/E 8201/440/3/60
description	pump inlet \varnothing 50mm outlet \varnothing 40mm type ZF350VSX 440V 60Hz 3 phase 0.75kW 1HP L 230mm rotation direction right LGB		



Part No.	499271	Ref. No.	12059 8214
description	pump inlet \varnothing 63mm outlet \varnothing 61mm type ZF650SX 230/400V 50Hz 3 phase 0.95kW L 340mm rotation direction right LGB		
For models:	ATR190AED		



Part No.	499083	Ref. No.	9821
description	pump inlet \varnothing 63mm outlet \varnothing 63mm type ZF650SX 230/400V 50Hz 3 phase 1.5kW L 335mm		
For models:	ALP01, ALP01E, ALP01EG, ALP01G, ALP42, ALP42P, ALP44, ALP44P, AT105, AT1050, AT105E, AT110, AT110E, AT116, ATR75		
spare parts for	499083		
	Part No.	510551	Ref. No. 6633
	pump cover gasket ID \varnothing 158.3mm pump type 1214/1293/1225/2243/1226/1204/3473/1241 thickness 3.53mm EPDM Qty 1 pcs		
	Part No.	510694	Ref. No. —
	mechanical shaft seal for shaft \varnothing 13mm height counter ring 8mm ID \varnothing 11.5mm H 16mm mounting \varnothing 24/26mm int. \varnothing 14mm		
	Part No.	521069	Ref. No. —
	fanwheel cover		
	Part No.	521240	Ref. No. 14145
	impeller \varnothing 110mm H 32mm rotation direction left thread M8L shaft \varnothing 20mm shaft length 10mm seat \varnothing 8.2mm blades 6		
	Part No.	521537	Ref. No. 14101
	pump cover inlet \varnothing 62mm outlet \varnothing 62mm auxiliary pressure connection 12mm supporting pressure closed turn direction right \varnothing 180mm ID \varnothing 150mm inner height 38mm		

booster pumps I





Part No.	499273	Ref. No.	14166
description	pump inlet \varnothing 1" IT outlet \varnothing 1" IT type PRA 0.80T 230-240V 50Hz 3 phase 1.1kW L 290mm rotation direction left EBARA		
For models:	ALP02, ALP02E, ALP02EG, ALP02G		



Part No.	499272	Ref. No.	12069 13183 8211 8211+8255
description	pump inlet \varnothing 1" IT outlet \varnothing 3/4" IT type ZF143SX 230/400V 50Hz 3 phase 0.18kW L 175mm rotation direction right LGB		
For models:	ALC100, ATR100, ATR130, ATR130ED, ATR160, ATR161, ATR190AED, ATR221, ATR311		



Part No.	500359	Ref. No.	1530
description	pump inlet \varnothing 12 outlet \varnothing 12 type PPL46DX 230V 50Hz 0.33kW capacitor 10 μ F LGB		
spare parts for	500359		
	Part No.	698663	Ref. No. —
	impeller \varnothing 60mm H 12mm with flute shaft intake \varnothing 12mm W 60mm suitable for LGB		
accessories for	500359		
	Part No.	365015	Ref. No. —
	operating capacitor capacity 10 μ F 400V tolerance 5%Hz ambient temperature max. -25 to +85°C \varnothing 35.5mm L 59mm M8 plastic connection male faston 6.3mm protection		

drain pumps

ASKOLL

Part No.	500196	Ref. No.	4751
description	drain pump		
For models:	AF610PS, AF610PSW, AF61DPS, AF61EPS, AF61EWP, AF61PS, AF-61PSW, AF780PS, AF780PSW, AF78DPS, AF78EDP, AF78EPS, AF78EWP, AF78PS, AF78PSW, AL402, AL40PS, AL45PS, AL55PS, AT105, AT1050, AT105E, AT110, AT110E, AT116, AT900, AT95		

1

Part No.	499253	Ref. No.	4755/P
description	drain pump 220V 32W 60Hz ASKOLL type R26 kit		
spare parts for	499253		
	Part No.	Ref. No.	4751/60
	drain pump inlet ømm outlet ømm 220V 32W 60Hz ASKOLL type R26		



1

Part No.	500214	Ref. No.	7965
description	drain pump inlet ø 30mm outlet ø 22mm 230/240V 30W 50Hz ASKOLL type R113		
For models:	AF61E, AF61ED, AF61EPS, AF61EW, AF61EWP, AF78E, AF78ED, AF78EDP, AF78EPS, AF78EW, AF78EWP, AF88E, AF88EP, AL40E, AL40ET, AL40PS, AL41E, AL45E, AL45ET, AL45PS, AL46E, ALP33E, KYRA2		



1

Part No.	499252	Ref. No.	4751/60
description	drain pump inlet ømm outlet ømm 220V 32W 60Hz ASKOLL type R26		
accessories for	499252		
	Part No.	Ref. No.	—
	screw ø 3.7mm L 20mm SS Qty 1 pcs head ø 7mm		

GRE



1

Part No.	500052	Ref. No.	4236
description	drain pump inlet ø 29mm outlet ø 22mm 100W 230V 50Hz GRE type 633		
For models:	AF73PS, AF78PS, AL50PS, AL60PS		

PLASET



1

Part No.	500354	Ref. No.	4755
description	drain pump inlet ø 30mm outlet ø 22mm 230V 30W 50Hz PLASET type 64079		
accessories for	500354		
	Part No.	Ref. No.	—
	drain hose ID ø 32mm ED ø 41mm L 1m wire reinforced		
	Part No.	Ref. No.	—
	drain hose DN19 L 1500mm straight ø inside 19mm straight ext. ø 24mm elbow ø inside 21mm elbow ext. ø 27mm outer hose ø 25mm		

condensators & interference suppression filters

filters

interference suppression filters



1

Part No.	365041	Ref. No.	14726
description	interference suppression filter		
For models:	AF88E, ALP33E, ALP44, ALP44P, AT112, AT114, AT116		



			
Part No.	365042	Ref. No.	1500
description	interference suppression filter capacity 0.33µF(X2)+2x0.015µF 1M0hm		
For models:	AF55, AF61, AF610, AF610D, AF610PS, AF610PSW, AF610W, AF61D, AF61DPS, AF61E, AF61ED, AF61EPS, AF61EW, AF61EWP, AF61PS, AF61PSW, AF61W, AF78, AF780, AF780D, AF780PS, AF780PSW, AF780W, AF78D, AF78DPS, AF78E, AF78ED, AF78EDP, AF78EPS, AF78EW, AF78EWP, AF78PS, AF78PSW, AF78W, AF88, AF880, AF88E, AF88EP, AL03, AL05, AL05D, AL07, AL07D, AL09, AL09D, AL10, AL11, AL15, AL16, AL20...(Other models you can see in the webshop)		

fuses

overload switches

			
Part No.	358516	Ref. No.	R65160320
description	overload switch drop-away current 2A		

electric accessories

terminals

connection terminals with screw/faston connections

			
Part No.	550349	Ref. No.	13162
description	power terminal block 4-pole max. 40A max 400V connection ø6mm ² / F6.3 temp.-resist. 150°C cross section 6mm ²		
For models:	AF78ED, AF78EDP, AL03, AL05, AL05D, AL07, AL07D, AL09, AL09D, AL40, AL402, AL40D, AL40E, AL40PS, AL41E, AL45, AL45D, AL45E, AL45PS, AL46E, AL54, AL54D, ALP01, ALP01G, ALP02, ALP02G, AZ75, AZ80, AZ90, AZ91, KYRA1		

			
Part No.	550411	Ref. No.	4201
description	power terminal block 6-pole max. 40A max 450V connection ø6mm ² / F6.3 temp.-resist. 150°C cross section 6mm ²		
For models:	AF55, AF61, AF610, AF610D, AF610PS, AF610PSW, AF610W, AF61D, AF61DPS, AF61E, AF61ED, AF61EPS, AF61EW, AF61EWP, AF61PS, AF61PSW, AF61W, AF73, AF73PS, AF78, AF780, AF780D, AF780PS, AF780PSW, AF780W, AF78D, AF78DPS, AF78E, AF78ED, AF78EDP, AF78EPS, AF78EW, AF78EWP, AF78PS, AF78PSW, AF78W, AF83, AF88, AF880, AF88E, AF88EP, AL50PS, AL55, AL55D, AL55PS, AL60PS, ALP33, ALP33E, ALP42, ALP42P...(Other models you can see in the webshop)		

gas taps





PEL





22S/O series

				
Part No.	101086	Ref. No.	K22011	
description	gas tap PEL type 22S/O gas inlet M20x1.5 (tube ø 12mm) bypass nozzle ø 0.35mm gas outlet M20x1.5 (tube ø 12/10mm) thermocouple connection M9x1 pilot connection M10x1 shaft ø 10x8mm shaft L 25/17mm shaft flat lower			
spare parts for	101086			
	Part No.	100259	Ref. No.	—
bypass nozzle type PEL22 bore ø 0.35mm thread M6x0.5				
	Part No.	101058	Ref. No.	—
magnet unit L 39mm D1 ø 15.4mm D2 ø 13.5mm suitable for PEL22/EGA24197 standard				
	Part No.	101201	Ref. No.	—
gas tap front part shaft ø 10x8mm shaft L 25/17mm shaft flat upper/lower suitable for PEL22				
	Part No.	101231	Ref. No.	—
thermocouple nut T1: M9x1 T2: M18x1				
	Part No.	101240	Ref. No.	—
gas connection thread M20x1.5 tube ø 12/10mm for PEL gas taps with gasket and screws horizontal				
	Part No.	101460	Ref. No.	—
O-ring ø 12.37mm D1 ø 2.62mm suitable for PEL22				
	Part No.	101461	Ref. No.	—
screw kit suitable for PEL22 Qty 4 pcs				
accessories for	101086			
	Part No.	100908	Ref. No.	—
union screw thread M10x1 for pipe ø 4mm Qty 1 pcs				
	Part No.	100909	Ref. No.	—
union screw thread M10x1 for pipe ø 6mm Qty 1 pcs				
	Part No.	101241	Ref. No.	—
gas connection thread M20x1.5 tube ø 12/10mm for PEL gas taps vertical				
	Part No.	101246	Ref. No.	—
olive for pipe ø 4mm Qty 1 pcs				
	Part No.	101248	Ref. No.	—
olive for pipe ø 12mm Qty 1 pcs suitable for PEL				
	Part No.	101249	Ref. No.	—
olive for pipe ø 10mm Qty 1 pcs				
	Part No.	101250	Ref. No.	—
union nut thread M20x1.5 for pipe ø 10mm				

Table continues overleaf



accessories for		101086		
	Part No.	101251	Ref. No.	—
	union nut thread M20x1.5 for pipe ø 12mm			
	Part No.	101286	Ref. No.	—
	olive ID ø 6mm Qty 1 pcs			
	Part No.	110080	Ref. No.	—
	knob ø 70mm shaft ø 10x8mm shaft flat universal			
	Part No.	112206	Ref. No.	—
	knob dial plate silver gas tap PEL21/22/23 t.max.°C ED ø 63mm ID ø 45.5mm			

accessories for		101908		
	Part No.	101312	Ref. No.	—
	microswitch			
	Part No.	101314	Ref. No.	—
	solenoid coil 24V 50Hz			
	Part No.	101317	Ref. No.	—
	plug with cable L 1000mm suitable for NOVASIT			
	Part No.	101318	Ref. No.	—
	cover cap for solenoid coil suitable for NOVASIT			

gas valves and ignition boxes







gas control valves

SIT

NOVASIT



1

Part No.	101908	Ref. No.	K00055	
description	gas valve SIT series Novasit 820 230V 50Hz gas inlet 1/2" gas outlet 1/2" thermocouple connection M9x1 pilot connection M10x1 ignition pressurebar pressure regulator connection blind equiv. no. 0.820.018 output pilot burner M10x1 input pressure max. 60bar setting range 3-30bar			
spare parts for	101908			
	Part No.	101065	Ref. No.	—
	magnet unit with cable L 44mm D1 ø 30mm D2 ø 20mm suitable for NOVASIT			
	Part No.	101313	Ref. No.	—
	solenoid coil 230V 50Hz			
accessories for	101908			
	Part No.	100006	Ref. No.	—
	piezoelectric igniter suitable for ELETTRISIT body plastic blowing connection ø2.4mm ø 14mm			
	Part No.	101305	Ref. No.	—
	gas connection straight 1/2" flange 45x45mm ELETTRISIT/V4400/4600/4605 suitable for SIT/HONEYWELL hole distance 36x36mm			
	Part No.	101306	Ref. No.	—
	gas connection angled flange 45x45mm hole distance 36x36mm 1/2" ELETTRISIT/V4400/4600/4605 screw with O-ring suitable for SIT/HONEYWELL			
	Part No.	101307	Ref. No.	—
	gas connection straight flange 45x45mm hole distance 36x36mm 3/4" ELETTRISIT/V4400/4600/4605 screw with O-ring suitable for SIT/HONEYWELL			
	Part No.	101308	Ref. No.	—
	gas connection angled flange 45x45mm hole distance 36x36mm 3/4" ELETTRISIT/V4400/4600/4605 screw with O-ring suitable for SIT/HONEYWELL			

ignition parts

pilot burners

POLIDORO

pilot burners







1

Part No.	100051	Ref. No.	K22029	
description	pilot burner POLIDORO 3 flames code gas connectionmm			
spare parts for	100051			
	Part No.	100907	Ref. No.	—
	screw connection thread M10x1 Qty 1 pcs type SEF 1 ømm for thermocouple			
accessories for	100051			
	Part No.	100000	Ref. No.	—
	pilot burner nozzle POLIDORO LPG code 22 bore ø 0.22mm Qty 1 pcs			
	Part No.	100208	Ref. No.	—
	pilot burner nozzle POLIDORO LPG code 20 bore ø 0.2mm Qty 1 pcs			
	Part No.	100209	Ref. No.	—
	pilot burner nozzle POLIDORO natural gas code 40 bore ø 0.4mm Qty 1 pcs			
	Part No.	100701	Ref. No.	—
	ignition electrode connection M4 Qty 1 pcs			
	Part No.	100906	Ref. No.	—
	screw connection thread M10x1 for ignition electrode brass Qty 1 pcs WS 10			
	Part No.	100907	Ref. No.	—
	screw connection thread M10x1 Qty 1 pcs type SEF 1 ømm for thermocouple			
	Part No.	100908	Ref. No.	—
	union screw thread M10x1 for pipe ø 4mm Qty 1 pcs			
	Part No.	100909	Ref. No.	—
	union screw thread M10x1 for pipe ø 6mm Qty 1 pcs			
	Part No.	102110	Ref. No.	—
	pilot tube copper pipe ø 4mm thickness 1mm L 3000mm			

Table continues overleaf



accessories for		100051	
Part No.	Ref. No.	Ref. No.	—
	102111	—	—
pilot tube copper pipe ø 6mm thickness 1mm L 3000mm			
	102508	—	—
union screw thread M10x1 for pipe ø 4mm Qty 5 pcs			
	102509	—	—
union screw thread M10x1 for pipe ø 6mm Qty 5 pcs			
	102699	—	—
pilot burner nozzle POLIDORO natural gas code 25.2 bore ø 2x0.25mm Qty 1 pcs 2 bores			
	102795	—	—
olive for pipe ø 4mm Qty 1 pcs			
	102797	—	—
olive for pipe ø 6mm Qty 1 pcs			
	106703	—	—
pilot burner nozzle POLIDORO natural gas code 27.2 bore ø 2x0.27mm Qty 1 pcs			
	106704	—	—
pilot burner nozzle POLIDORO LPG code 16.2 bore ø 2x0.16mm Qty 1 pcs			
	106763	—	—
pilot burner nozzle POLIDORO natural gas code 27.2A bore ø 2x 0.27mm Qty 1 pcs			
	106859	—	—
pilot burner nozzle POLIDORO LPG code 24 bore ø 0.24mm Qty 1 pcs			

spare parts for		107189	
Part No.	Ref. No.	Ref. No.	—
	100917	—	—
gasket for pilot burner Qty 1 pcs aluminium			
	100918	—	—
screw for pilot burner			
	107701	—	—
pilot burner bottom part SIT 100 series nozzle ø 0.2mm			

thermocouples

plug-in thermocouples

plug-in thermocouples standard

with barrel socket ø6(6.5)mm

thermocouples SIT

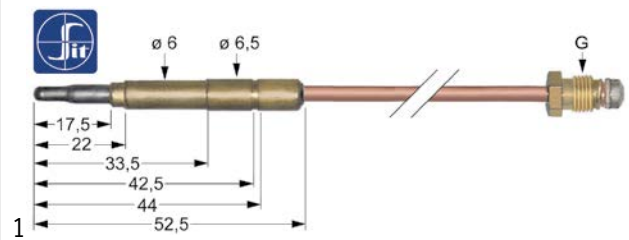





Part No.	Ref. No.	Ref. No.	K22176
description thermocouple SIT M9x1 L 850mm plug connection ø6.0(6.5)mm			

producer-specific pilot burners

ATA



Part No.	Ref. No.	Ref. No.	K22015
description pilot burner SIT 1 flame nozzle ø 0.2mm gas connectionmm			
spare parts for		107189	
	100245	—	—
pilot burner nozzle LPG code 20 bore ø 0.2mm Qty 1 pcs thread M8x0.75			
	100832	—	—
pilot burner cap 1 flame suitable for 100 series Hmm Lmm Qty 1 pcs			
	100854	—	—
pilot burner bracket double			
	100885	—	—
air mixing sleeve for pilot burner Qty 1 pcs			
	100916	—	—
compression spring for pilot burner Qty 1 pcs			

equipment-specific units

for dishwashers

drain and intake components

ATA

drain /intake bodies



Part No.	Ref. No.	Ref. No.	6860
description drain fitting complete thread 1" hose ø 24mm			
For models: AL07, AL07D, AL09, AL09D, AL10, AL11, AL15, AL16, AL20, AL20D, AL25, AL25D, AL40, AL402, AL40D, AL40E, AL40PS, AL41E, AL45, AL45D, AL45E, AL45PS, AL46E, AZ91, KYRA1, KYRA1WAG, KYRA2			

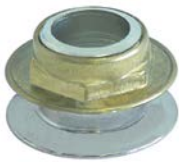

Part No.	Ref. No.	Ref. No.	1071
description drain fitting ID ø 23mm			
For models: AL03, AL05, AL05D			

1

Part No.	516067	Ref. No.	7151
description	drain fitting thread 1"		
For models:	AL10, AL11, AL15, AL16, AL20, AL21, AL25, AL26, AL30, AL31, AL35, AL36, AL40, AL40D, AL40E, AL40ET, AL40PS, AL41, AL41E, AL45, AL45D, AL45E, AL45ET, AL45PS, AL46, AL46E, AZ91		



1

Part No.	516071	Ref. No.	4122
description	drain fitting thread 1 1/2" ED ø 67mm H 39mm ID ø 42mm		
For models:	AF55, AF61, AF610, AF610D, AF610PS, AF610PSW, AF610W, AF61D, AF61DPS, AF61E, AF61ED, AF61EPS, AF61EW, AF61EWP, AF61PS, AF61PSW, AF61W, AF73, AF73PS, AF78, AF780, AF780D, AF780PS, AF780PSW, AF780W, AF78D, AF78DPS, AF78E, AF78ED, AF78EDP, AF78EPS, AF78EW, AF78EWP, AF78PS, AF78PSW, AF78W, AF83, AF88, AF880, AF88E, AF88EP, AL50, AL50PS, AL54, AL54D, AL55, AL55D, AL55PS, AL60, AL60PS...(Other models you can see in the webshop)		
accessories for	516071		
	Part No.	516073	Ref. No.
			4124
	nut thread 1 1/2" ø 66mm H 10.5mm WS 52 brass Qty 1 pcs		
	Part No.	516123	Ref. No.
			4123
	flat gasket rubber ED ø 65mm ID ø 50mm thickness 3mm Qty 1 pcs		



1

Part No.	516146	Ref. No.	7201
description	flat gasket rubber ED ø 30mm ID ø 19mm thickness 3mm Qty 1 pcs		
For models:	AL10, AL11, AL16, AL20, AL21, AL25, AL26, AL30, AL31, AL35, AL36, AL40, AL40D, AL40E, AL40PS, AL41, AL41E, AL45, AL45D, AL45E, AL45PS, AL46, AL46E, AZ91		



1

Part No.	516074	Ref. No.	4125
description	flat gasket rubber ED ø 45mm ID ø 34mm thickness 4mm Qty 1 pcs		
For models:	AF55, AF61, AF610, AF610D, AF610PS, AF610PSW, AF610W, AF61D, AF61DPS, AF61E, AF61ED, AF61EPS, AF61EW, AF61EWP, AF61PS, AF61PSW, AF61W, AF73, AF73PS, AF78, AF780, AF780D, AF780PS, AF780PSW, AF780W, AF78D, AF78DPS, AF78E, AF78ED, AF78EDP, AF78EPS, AF78EW, AF78EWP, AF78PS, AF78PSW, AF78W, AF83, AF88, AF880, AF88E, AF88EP, AL50, AL50PS, AL54, AL54D, AL55, AL55D, AL55PS, AL60, AL60PS...(Other models you can see in the webshop)		



1

Part No.	516123	Ref. No.	4123
description	flat gasket rubber ED ø 65mm ID ø 50mm thickness 3mm Qty 1 pcs		
For models:	AF55, AF61, AF610, AF610D, AF610PS, AF610PSW, AF610W, AF61D, AF61DPS, AF61E, AF61ED, AF61EPS, AF61EW, AF61EWP, AF61PS, AF61PSW, AF61W, AF73, AF73PS, AF78, AF780, AF780D, AF780PS, AF780PSW, AF780W, AF78D, AF78DPS, AF78E, AF78ED, AF78EDP, AF78EPS, AF78EW, AF78EWP, AF78PS, AF78PSW, AF78W, AF83, AF88, AF880, AF88E, AF88EP, AL50, AL50PS, AL54, AL54D, AL55, AL55D, AL55PS, AL60, AL60PS...(Other models you can see in the webshop)		



1

Part No.	516053	Ref. No.	4640
description	hose connector ED ø 44mm H 24mm ID ø 24mm		
For models:	AF73PS, AF78PS, AL50PS, AL55PS, AL60PS, AT105, AT105D, AT105E, AT110, AT110E, AT116, AT900, AT95		



1

Part No.	516110	Ref. No.	1072
description	hose connector hose ø 23mm		
For models:	AL03, AL05, AL05D		



1

Part No.	516070	Ref. No.	7154
description	intake body thread 1"		
For models:	AL10, AL11, AL15, AL16, AL20, AL21, AL25, AL26, AL30, AL31, AL35, AL36, AL40, AL40D, AL40E, AL40ET, AL40PS, AL41, AL41E, AL45, AL45D, AL45E, AL45ET, AL45PS, AL46, AL46E, AZ91		



1

Part No.	516076	Ref. No.	4126
description	intake body thread 1 1/2" hose ø 40mm		
For models:	AF55, AF73, AF78, AF83, AF88, AF880, AL50, AL54, AL54D, AL55, AL55D, AL60, ALP33, ALP42, ALP42P, AT105, AT105E, AT106, AT110, AT110E, AT112, AT114, AT116, AT900, AT95, ATR75, AZ80, AZ90		



1



Part No.	516136	Ref. No.	4368
description	intake body thread 1 1/2" IT - 1 1/4" ET		
For models:	AF61, AF610, AF610D, AF610PS, AF610PSW, AF610W, AF61D, AF61DPS, AF61E, AF61ED, AF61EPS, AF61EW, AF61EWP, AF61PS, AF61PSW, AF61W, AF78, AF780, AF780D, AF780PS, AF780PSW, AF780W, AF78D, AF78DPS, AF78E, AF78ED, AF78EDP, AF78EPS, AF78EW, AF78EWP, AF78PS, AF78PSW, AF78W, AF88, AME540		

1



Part No.	516069	Ref. No.	7153
description	nut thread 1" ø 46mm H 8mm WS 36 brass Qty 1 pcs		
For models:	AL10, AL11, AL15, AL16, AL20, AL21, AL25, AL26, AL30, AL31, AL35, AL36, AL40, AL40D, AL40E, AL40ET, AL40PS, AL41, AL41E, AL45, AL45D, AL45E, AL45ET, AL45PS, AL46, AL46E, AZ91		

1



Part No.	516073	Ref. No.	4124
description	nut thread 1 1/2" ø 66mm H 10.5mm WS 52 brass Qty 1 pcs		
For models:	AF55, AF61, AF610, AF610D, AF610PS, AF610PSW, AF610W, AF61D, AF61DPS, AF61E, AF61ED, AF61EPS, AF61EW, AF61EWP, AF61PS, AF61PSW, AF61W, AF73, AF73PS, AF78, AF780, AF780D, AF780PS, AF780PSW, AF780W, AF78D, AF78DPS, AF78E, AF78ED, AF78EDP, AF78EPS, AF78EW, AF78EWP, AF78PS, AF78PSW, AF78W, AF83, AF88, AF880, AF88E, AF88EP, AL50, AL50PS, AL54, AL54D, AL55, AL55D, AL55PS, AL60, AL60PS...(Other models you can see in the webshop)		

1



Part No.	510769	Ref. No.	4615
description	O-ring EPDM thickness 2.62mm ID ø 25.07mm Qty 1 pcs		
For models:	AF78, AF78PS, AF83, AF88, AL03, AL05, AL05D, AL31, AL36, AL41, AL41E, AL46, AL46E, AL60, AL60PS, AT105, AT106, AT95		

1



Part No.	516075	Ref. No.	4127
description	union nut thread 1 1/2"		
For models:	AF73, AF73PS, AF78, AF78PS, AF83, AF88, AF88E, AF88EP, AL50, AL50PS, AL55PS, AL60, AL60PS, ALP33E, AT105, AT105D, AT105E, AT106, AT110, AT110E, AT116, AT900, AT95		

filters

1



Part No.	507547	Ref. No.	11064
description	filter for dishwasher H 60mm L 257mm W 127mm		
For models:	ATR75		

1



Part No.	516185	Ref. No.	6820 6820/6834
description	flat filter		
For models:	AL10, AL11, AL15, AL16, AL20, AL20D, AL25, AL25D, AL40, AL40D, AL40E, AL40PS, AL41E, AL45, AL45D, AL45E, AL45PS, AL46E		

1



Part No.	516196	Ref. No.	9723
description	flat filter		
For models:	AT105, AT105D, AT105E, AT110, AT110E, AT112, AT114, AT116		

1



Part No.	516215	Ref. No.	4750
description	flat filter		
For models:	AF61, AF610, AF610D, AF610PS, AF610PSW, AF610W, AF61D, AF61DPS, AF61E, AF61ED, AF61EPS, AF61EW, AF61EWP, AF61PS, AF61PSW, AF61W, AF78, AF780, AF780D, AF780PS, AF780PSW, AF780W, AF78D, AF78DPS, AF78E, AF78ED, AF78EDP, AF78EPS, AF78EW, AF78EWP, AF78PS, AF78PSW, AF78W, AME540		

1

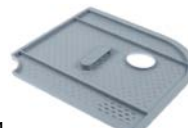

Part No.	507550	Ref. No.	5845
description	flat filter for dishwasher H 13mm L 260mm W 260mm plastic with hole		
For models:	AF55, AT900		

1





Part No.	507551	Ref. No.	5846+5847
description	flat filter for dishwasher H 13mm L 260mm W 260mm plastic without hole		

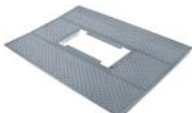



 <p>1</p>			
Part No.	517513	Ref. No.	11063
description	flat filter for dishwasher H 35mm L 594mm W 434mm		
For models:	ATR75		

 <p>1</p>			
Part No.	516216	Ref. No.	4758
description	flat filter L 515mm W 215mm		
For models:	AF88, AF880, AF88E, AF88EP, ALP33, ALP33E		

 <p>1</p>			
Part No.	516197	Ref. No.	9724
description	rectangular filter		
For models:	AT105, AT1050, AT105E, AT110, AT110E, AT112, AT114, AT116		

 <p>1</p>			
Part No.	516195	Ref. No.	9722
description	rectangular filter H 80mm		
For models:	AF88, AF880, AF88E, AF88EP, ALP33, ALP33E, ALP42, ALP42P, ALP44, ALP44P, AT105, AT1050, AT105E, AT110, AT110E, AT112, AT114, AT116, AT95, ATR100, ATR130, ATR130ED, ATR160, ATR190AED, ATR75		

 <p>1</p>			
Part No.	507548	Ref. No.	4973
description	round filters for dishwasher ø 80mm H 135mm		

 <p>1</p>			
Part No.	516173	Ref. No.	4844
description	round filters ø 160mm H 65mm		
For models:	AF55, AL54, AL54D, AL55, AL55D, AL55PS, AT900		

 <p>1</p>			
Part No.	516079	Ref. No.	1029
description	round filters ø 508mm H 55mm		
For models:	AL07, AL07D, AL09, AL09D, AL10, AL11, AL15, AL16, AL20, AL21, AL25, AL26, AL30, AL31, AL35, AL36, AL40, AL40E, AL40ET, AL40PS, AL41, AL41E, AL45, AL45E, AL45ET, AL45PS, AL46, AL46E, ALC100, ATR100, ATR130, ATR130ED, ATR160, ATR161, ATR190AED, ATR221, ATR311		

 <p>1</p>			
Part No.	516161	Ref. No.	7855
description	round filters ø 55mm H 55mm		
For models:	AF61E, AF61ED, AF61EPS, AF61EW, AF61EWP, AF78E, AF78ED, AF78EDP, AF78EPS, AF78EW, AF78EWP, AF88E, AF88EP, AL03, AL05, AL05D, AL40E, AL40ET, AL45E, AL45ET, ALP33E		

 <p>1</p>			
Part No.	516131	Ref. No.	4352
description	round filters ø 80mm H 133mm		
For models:	AF61, AF610, AF610D, AF610PS, AF610PSW, AF610W, AF61D, AF61DPS, AF61E, AF61ED, AF61EPS, AF61EW, AF61EWP, AF61PS, AF61PSW, AF61W, AF78, AF780, AF780D, AF780PS, AF780PSW, AF780W, AF78D, AF78DPS, AF78E, AF78ED, AF78EDP, AF78EPS, AF78EW, AF78EWP, AF78PS, AF78PSW, AF78W, AME540		

overflow pipes

 <p>1</p>			
Part No.	516104	Ref. No.	7277
description	overflow pipe		
For models:	AL40PS, AL45PS		

 <p>1</p>			
Part No.	516105	Ref. No.	9665
description	overflow pipe		
For models:	AF88, AF88E, ALP33, ALP33E, ALP42, ALP42P		



1



Part No.	516252	Ref. No.	6833
description	overflow pipe L 120mm ø 29mm		
For models:	AL10, AL11, AL15, AL16, AL20, AL20D, AL25, AL25D, AL40, AL40D, AL40E, AL40PS, AL41E, AL45, AL45D, AL45E, AL45PS, AL46E		

1



Part No.	516124	Ref. No.	4134 4157
description	overflow pipe L 128mm ø 42mm		
For models:	AL54, AL54D, AL55, AL55D		

1



Part No.	512504	Ref. No.	5852
description	overflow pipe L 130mm ø 40mm		
For models:	AF55		

1



Part No.	517511	Ref. No.	4139
description	overflow pipe L 130mm ø 40mm		
For models:	AL55PS		

1



Part No.	510766	Ref. No.	4121
description	overflow pipe L 155mm ø 42mm		
For models:	AF73, AF73PS, AF78, AF78PS, AL50, AL50PS, AL60, AL60PS		

1



Part No.	510767	Ref. No.	5121
description	overflow pipe L 175mm ø 42mm		
For models:	AF83, AF88, AT105, AT106, AT95		

1



Part No.	516106	Ref. No.	9629 9738
description	overflow pipe L 217mm ø 42mm		
For models:	AF61, AF610, AF610D, AF610PS, AF610PSW, AF610W, AF61D, AF61DPS, AF61E, AF61ED, AF61EPS, AF61EW, AF61EWP, AF61PS, AF61PSW, AF61W, AF78, AF780, AF780D, AF780PS, AF780PSW, AF780W, AF78D, AF78DPS, AF78E, AF78ED, AF78EDP, AF78EPS, AF78EW, AF78EWP, AF78PS, AF78PSW, AF78W		

1



Part No.	516066	Ref. No.	9625 9737
description	overflow pipe L 317mm ø 42mm		
For models:	AF88, AT105, AT105E, AT110, AT110E, AT112, AT114, AT116, AT95, ATR75		

1



Part No.	516072	Ref. No.	9739
description	overflow pipe L 318mm ø 40mm		
For models:	AF88, AF880, AF88E, AF88EP, ALP33, ALP33E, ALP42, ALP42P		

1



Part No.	516084	Ref. No.	1107
description	standpipe L 120mm ø 22mm		
For models:	AL03, AL05, AL05D		



containers

container lids



1

Part No.	516087	Ref. No.	7226
description	container lid		
For models:	AF61ED, AF78ED, AF78EDP, AL31, AL36, AL41, AL41E, AL46, AL46E		



1

Part No.	516111	Ref. No.	1073
description	container lid suitable for rinse aid container		
For models:	AL30, AL31, AL35, AL36, AL40, AL41, AL45, AL46		

dosing containers



1



Part No.	516093	Ref. No.	7959
description	rinse aid container		
For models:	AL30, AL31, AL35, AL36, AL40, AL40D, AL40E, AL40ET, AL40PS, AL41, AL41E, AL45, AL45D, AL45E, AL45ET, AL45PS, AL46, AL46E, AT105		



salt tanks



1

Part No.	510929	Ref. No.	7642
description	salt tank ø 120mm H 117mm hose ø 10mm mounting ø 70mm overall height 157mm		
For models:	AF610D, AF61D, AF61DPS, AF780D, AF78D, AF78DPS, AL05D, AL07D, AL09D, AL11, AL16, AL20D, AL21, AL25D, AL26, AL40D, AL45D, AL54D, AL55D		

spare parts for	510929			
	Part No.	506015	Ref. No.	4616
	O-ring EPDM thickness 3.53mm ID ø 39.69mm Qty 1 pcs			
	Part No.	510018	Ref. No.	—
	nut ø 92mm H 10.5mm for salt tank ID ø 64mm			
	Part No.	524177	Ref. No.	—
	lid ø 69mm H 20mm for salt tank ID ø 50mm			

accessories for	510929			
	Part No.	510071	Ref. No.	—
	flat gasket rubber ED ø 81mm ID ø 68mm thickness 3mm for salt tank Qty 1 pcs			
	Part No.	510654	Ref. No.	—
	gasket H 6mm D1 ø 82mm D2 ø 68mm			
	Part No.	510883	Ref. No.	—
	gasket rubber ED ø 86mm ID ø 66mm thickness 2mm for salt tank Qty 1 pcs			

accessories



1

Part No.	516098	Ref. No.	7920
description	catch intake lancette gasket suitable for ATA equiv. no. 7920		
For models:	AL30, AL31, AL35, AL36, AL40, AL40D, AL40E, AL40ET, AL40PS, AL41, AL41E, AL45, AL45D, AL45E, AL45ET, AL45PS, AL46, AL46E, AT105		



1



Part No.	516189	Ref. No.	7969
description	funnel suitable for for dosing container		
For models:	AL30, AL31, AL35, AL36, AL40, AL40D, AL40E, AL40ET, AL40PS, AL41, AL41E, AL45, AL45D, AL45E, AL45ET, AL45PS, AL46, AL46E, AT105		

boilers

boilers for dishwashers

1



Part No.	516041	Ref. No.	4496
description	boiler		
For models:	AF61, AF610, AF610D, AF610PS, AF610PSW, AF610W, AF61D, AF61DPS, AF61E, AF61EPS, AF61EW, AF61EWP, AF61PS, AF61PSW, AF61W, AF78, AF780, AF780D, AF780PS, AF780PSW, AF780W, AF78D, AF78DPS, AF78E, AF78EPS, AF78EW, AF78EWP, AF78PS, AF78PSW, AF78W, AF88, AF880, AF88E, AF88EP, AL54, AL54D, AL55, AL55D, AL55PS, ALP33, ALP33E, AME540		

1



Part No.	516147	Ref. No.	7330
description	boiler		
For models:	AL03, AL05, AL05D		

1



Part No.	516163	Ref. No.	7890
description	boiler		
For models:	AL07, AL07D, AL09, AL09D, AL10, AL11, AL15, AL16, AL20, AL20D, AL21, AL25, AL25D, AL26, AL30, AL35, AL40, AL402, AL40D, AL40E, AL40ET, AL40PS, AL45, AL45D, AL45E, AL45ET, AL45PS, ALP42, ALP42P, ALP44, ALP44P, KYRA1, KYRA1WAG, KYRA2		

1



Part No.	516181	Ref. No.	6528
description	boiler		
For models:	AT105, AT1050, AT105E, AT110, AT110E, AT116		

1



Part No.	516182	Ref. No.	6743
description	boiler		
For models:	AL41E, AL46E		

1



Part No.	516233	Ref. No.	4150
description	boiler		
For models:	AF73, AF73PS, AF78, AF78PS, AF83, AF88, AL50, AL50PS, AL60, AL60PS		

1



Part No.	516234	Ref. No.	4577
description	boiler		
For models:	AF73, AF73PS, AF78, AF78PS, AF83, AF88, AL50, AL50PS, AL60, AL60PS, AT105		

1



Part No.	516190	Ref. No.	9564
description	boiler ø 140mm L 550mm		
For models:	ALP42, ALP42P, ALP44, ALP44P, AT105, AT1050, AT105E, AT110, AT110E, AT112, AT114, AT116, AT95		



rotation plates

rotation plate bearings

1

Part No.	516223	Ref. No.	2003
description	bearing for rotation plate		
For models:	AL10, AL11, AL15, AL16, AL30, AL31, AL35, AL36		

complete



1

Part No.	516235	Ref. No.	A6862
description	rotation plate with wash arm conversion kit AL10/15/16		



1

Part No.	516236	Ref. No.	A6863
description	rotation plate with wash arm conversion kit AL30/31		



1

Part No.	516237	Ref. No.	A6864
description	rotation plate with wash arm conversion kit AL35/36		

accessories



1

Part No.	516221	Ref. No.	7603
description	disc ø 18.8mm blind thickness 1mm		
For models:	AL10, AL11, AL15, AL16, AL30, AL31, AL35, AL36		



1

Part No.	516224	Ref. No.	7861
description	shim		
For models:	AL10, AL11, AL15, AL16, AL30, AL31, AL35, AL36		

softener cartridges

softening columns



1

Part No.	530000	Ref. No.	7641
description	softener 4-fold L 380mm W 180mm		
For models:	AF610D, AF61D, AF61DPS, AF780D, AF78D, AF78DPS, AL05D, AL07D, AL09D, AL11, AL16, AL20D, AL21, AL25D, AL26, AL40D, AL45D, AL54D, AL55D		



complete



1

Part No.	516086	Ref. No.	7211
description	softener		
For models:	AF61ED, AF78ED, AF78EDP, AL31, AL36, AL41, AL41E, AL46, AL46E		
spare parts for	516086		



Part No.	516087	Ref. No.	7226
description	container lid		

housing and bezels

miscellaneous



1

Part No.	110741	Ref. No.	7913
description	sleeve for knob		
For models:	AF61, AF61D, AF61DPS, AF61PS, AF61PSW, AF61W, AF78, AF78D, AF78DPS, AF78PS, AF88, AL30, AL31, AL35, AL36, AL40, AL40D, AL40PS, AL41, AL45, AL45D, AL45PS, AL46, AME540, AT105, AT110, AT900, AT95		

hood mechanics for dishwashers

bolts



1

Part No.	516228	Ref. No.	9619
description	bolt hood mechanics		
For models:	ALP01, ALP01E, ALP02, ALP02E, AT105, AT95		

accessories for 516228



Part No.	516198	Ref. No.	52061
description	retaining ring E D1 ø 6mm D2 ø 12mm SS DIN 6799 thickness 0.7mm for shaft ø 7-9mm		



1

Part No.	516178	Ref. No.	6088
description	screw bolt for hood joint		
For models:	AT105, AT106		



1

Part No.	516176	Ref. No.	6086
description	lever joint hood mechanics		
For models:	AT105, AT106		

rollers



1

Part No.	516192	Ref. No.	9634
description	roller hood mechanics		
For models:	ALP01, ALP01E, ALP02, ALP02E, AT105, AT95		



1

Part No.	516250	Ref. No.	9612
description	roller ø 47mm H 33mm for hood linkage hole ø 8mm		
For models:	AT105, AT105E, AT110, AT110E, AT112, AT114, AT116, AT95		

cable controls



1

Part No.	516194	Ref. No.	9713
description	hauling cable hood mechanics		
For models:	AT105, AT95		



1

Part No.	524510	Ref. No.	9668
description	hauling cable L 1100mm wire gauge ø 3mm for hood mechanics		
For models:	AT105, AT105E, AT110, AT110E, AT112, AT114, AT116, AT95		

miscellaneous



1



Part No.	516179	Ref. No.	6090
description	slide bearing hood mechanics		
For models:	AT105, AT106		





			
1			
Part No.	516177	Ref. No.	6087
description	threaded part for hood joint		
For models:	AT105, AT106		

air traps

air traps

			
1			
Part No.	516241	Ref. No.	6805 7690
description	air trap		
For models:	AL03, AL05, AL05D, AL07, AL07D, AL09, AL09D, AL10, AL11, AL15, AL16, AL20, AL20D, AL21, AL25, AL25D, AL26, AL30, AL31, AL35, AL36, AL40, AL40D, AL40E, AL40PS, AL41, AL41E, AL45, AL45D, AL45E, AL45PS, AL46, AL46E, AL54, AL54D, AL55, AL55D, AL55PS, ALP01, ALP01E, ALP01EG, ALP01G, ALP02, ALP02E, ALP02EG, ALP02G, AT105, AT105D, AT105E, AT110...(Other models you can see in the webshop)		
accessories for	516241		
	Part No.	528485	Ref. No. 4692
	 O-ring EPDM thickness 1.78mm ID ø 6.07mm Qty 1 pcs		

			
1			
Part No.	510111	Ref. No.	2517 4660 7140
description	air trap ø 34mm H 130mm hose ø 6mm plastic		
For models:	AF73PS, AF78PS, AL30, AL31, AL35, AL36, AL40, AL41, AL45, AL46, AL50, AL50PS, AL60, AL60PS		
spare parts for	510111		
	Part No.	504618	Ref. No. —
	 O-ring EPDM thickness 2.62mm ID ø 15.54mm Qty 1 pcs		
	Part No.	510075	Ref. No. —
	 flat gasket rubber ED ø 22mm ID ø 13mm thickness 1.5mm Qty 1 pcs		
	Part No.	510106	Ref. No. —
	 hose connector for air trap		

			
1			
Part No.	516169	Ref. No.	4690 9698
description	air trap W 83mm H 110mm hose ø 6mm		
For models:	AF61, AF610, AF610D, AF610PS, AF610PSW, AF610W, AF61D, AF61DPS, AF61E, AF61ED, AF61EPS, AF61EW, AF61EWP, AF61PS, AF61PSW, AF61W, AF73, AF73PS, AF78, AF780, AF780D, AF780PS, AF780PSW, AF780W, AF78D, AF78DPS, AF78E, AF78ED, AF78EDP, AF78EPS, AF78EW, AF78EWP, AF78PS, AF78PSW, AF78W, AF83, AF88, AF880, AF88E, AF88EP, AL50, AL50PS, AL60, AL60PS, ALP01, ALP01E, ALP01EG, ALP01G, ALP02, ALP02E...(Other models you can see in the webshop)		

mechanics for flight type dishwashers

			
1			
Part No.	516259	Ref. No.	13628
description	bearing L 37.6mm ø 56mm hole ø 25.2mm suitable for ATA for ALC, ATR		
For models:	ALC100, ATR100, ATR130, ATR130ED, ATR160, ATR161, ATR190AED, ATR221, ATR311, ATR75		

			
1			
Part No.	517360	Ref. No.	13450 neu (ab 2005)
description	drive shaft for transport system since 2005 L 173mm ø 24mm suitable for ATA		

			
1			
Part No.	517359	Ref. No.	13450 alt (bis 2004)
description	drive shaft for transport system until 2004 L 173mm ø 25mm suitable for ATA		

			
1			
Part No.	516258	Ref. No.	13629
description	flat gasket PTFE ED ø 32.5mm ID ø 25.5mm thickness 4mm Qty 1 pcs		
For models:	ALC100, ATR100, ATR130, ATR130ED, ATR160, ATR161, ATR190AED, ATR221, ATR311, ATR75		



backflow preventers

backflow preventers



1

Part No.	516102	Ref. No.	1130 1616 1616 nicht bekannt
description	backflow preventer dishwasher		
For models:	AF55, AF61, AF610, AF610D, AF610PS, AF61D, AF61DPS, AF61E, AF61ED, AF61EPS, AF61PS, AF78, AF780, AF780D, AF780PS, AF780PSW, AF780W, AF78D, AF78DPS, AF78E, AF78ED, AF78EDP, AF78EPS, AF78PS, AF88, AF880, AF88E, AF88EP, AL03, AL05, AL05D, AL07, AL07D, AL09, AL09D, AL10, AL11, AL15, AL16, AL20, AL20D, AL25, AL25D, AL40, AL402, AL40D, AL40E, AL40PS, AL41E, AL45... (Other models you can see in the webshop)		



1

Part No.	516229	Ref. No.	1610
description	backflow preventer dishwasher		
For models:	AF61D, AF61DPS, AF78D, AF78DPS, AF78ED, AF78EDP, AL05D, AL11, AL16, AL21, AL26, AL31, AL36, AL40D, AL41, AL41E, AL45D, AL46, AL46E, AL54D, AL55D, ALP01, ALP02		



1

Part No.	516101	Ref. No.	1605
description	backflow preventer dishwasher hose ø 12mm		
For models:	AF61, AF61D, AF61DPS, AF61PS, AF78, AF78D, AF78DPS, AF78ED, AF78EDP, AF78EPS, AF78PS, AF88, AF88E, AL03, AL05, AL05D, AL10, AL11, AL15, AL16, AL20, AL21, AL25, AL26, AL30, AL31, AL35, AL36, AL40, AL40D, AL40E, AL40PS, AL41, AL41E, AL45, AL45D, AL45E, AL45PS, AL46, AL46E, AL54, AL54D, AL55, AL55D, AL55PS, ALC100, ALP33, ALP33E, ALP42, ALP42P... (Other models you can see in the webshop)		

spare parts for 516101

Part No.	506367	Ref. No.	—
description	flat gasket rubber ED ø 40mm ID ø 28mm thickness 1.8mm Qty 1 pcs		

miscellaneous



1

Part No.	516257	Ref. No.	11069
description	spindle L 24mm D1 ø 12mm D2 ø 15mm		

door mechanics

springs

torsion springs

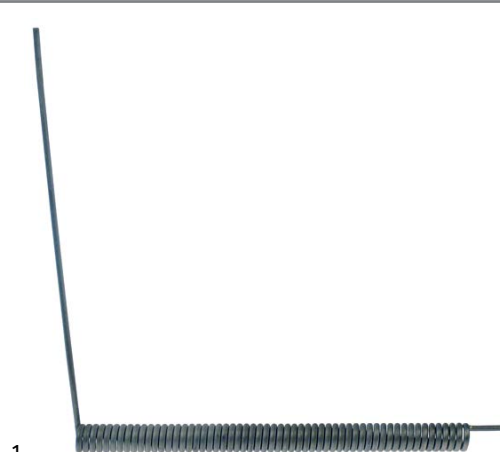

1

Part No.	516243	Ref. No.	4084
description	spring mounting pos. left		
For models:	AF55, AF61, AF610, AF610D, AF610PS, AF610PSW, AF610W, AF61D, AF61DPS, AF61E, AF61ED, AF61EPS, AF61EW, AF61EWP, AF61PS, AF61PSW, AF61W, AF73, AF73PS, AF78, AF780, AF780D, AF780PS, AF780PSW, AF780W, AF78D, AF78DPS, AF78E, AF78ED, AF78EDP, AF78EPS, AF78EW, AF78EWP, AF78PS, AF78PSW, AF78W, AF83, AF88, AF880, AF88E, AF88EP, AL50, AL50PS, AL55, AL55D, AL55PS, AL60, AL60PS, ALP33, ALP33E... (Other models you can see in the webshop)		

hinges



1

Part No.	516089	Ref. No.	7161
description	spring assisted hinge spring hinge		
For models:	AL07, AL07D, AL09, AL09D, AL10, AL11, AL15, AL16, AL20, AL20D, AL21, AL25, AL25D, AL26, AL30, AL31, AL35, AL36, AL40, AL402, AL40D, AL40E, AL40ET, AL40PS, AL41, AL41E, AL45, AL45D, AL45E, AL45ET, AL45PS, AL46, AL46E, AL54, AL54D, KYRA1, KYRA1WAG, KYRA2		

door seals

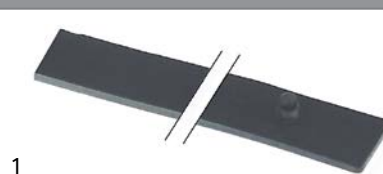



1

Part No.	516260	Ref. No.	4678
description	door seal L 597mm W 17mm H 9.5mm Qty 1 for dishwasher suitable for ATA for AL55 / AF55		
For models:	AF55, AL55, AL55D, AL55PS		





locks			
			
1			
Part No.	506250	Ref. No.	7362
description	door catch L 23mm thread M12 for ATA		





			
1			
Part No.	506251	Ref. No.	4357
description	door catch L 28mm thread M16 for ATA		
For models:	ATR100, ATR130, ATR130ED, ATR160, ATR190AED		
accessories for	506251		
		Part No.	506252
		Ref. No.	4355
	knurled nut ø 32.5mm thread M16 H 7mm		

miscellaneous			
			
1			
Part No.	517462	Ref. No.	14855
description	slide bearing for door mechanism		
For models:	ALP01, ALP01E, ALP02, ALP02E		

			
1			
Part No.	516115	Ref. No.	4086
description	spring compressor spring compressor		
For models:	AF55, AF61, AF610, AF610D, AF610PS, AF610PSW, AF610W, AF61D, AF61DPS, AF61E, AF61ED, AF61EPS, AF61EW, AF61EWP, AF61PS, AF61PSW, AF61W, AF73, AF73PS, AF78, AF780, AF780D, AF780PS, AF780PSW, AF780W, AF78D, AF78DPS, AF78E, AF78ED, AF78EDP, AF78EPS, AF78EW, AF78EWP, AF78PS, AF78PSW, AF78W, AF83, AF88, AF880, AF88E, AF88EP, AL50, AL50PS, AL55, AL55D, AL55PS, AL60, AL60PS, ALP33, ALP33E...(Other models you can see in the webshop)		

			
1			
Part No.	516180	Ref. No.	6091
description	spring compressor tension adjuster		
For models:	AT105, AT106, AT900		

screw connections			
			
1			
Part No.	516226	Ref. No.	2007
description	locknut		
For models:	AL10, AL11, AL15, AL16, AL30, AL31, AL35, AL36		

washing and rinsing systems			
			
1			
Part No.	506252	Ref. No.	4355
description	knurled nut ø 32.5mm thread M16 H 7mm		
For models:	AF61, AF610, AF610D, AF610PS, AF610PSW, AF610W, AF61D, AF61DPS, AF61E, AF61ED, AF61EPS, AF61EW, AF61EWP, AF61PS, AF61PSW, AF61W, AF78, AF780, AF780D, AF780PS, AF780PSW, AF780W, AF78D, AF78DPS, AF78E, AF78ED, AF78EDP, AF78EPS, AF78EW, AF78EWP, AF78PS, AF78PSW, AF78W, AF88, AF880, AF88E, AF88EP, AL03, AL05, AL05D, AL07, AL07D, AL09, AL09D, AL20, AL20D, AL25, AL25D, AL55, AL55D...(Other models you can see in the webshop)		
spare parts for	506252		
		Part No.	516153
		Ref. No.	7381
	rinse arm L 370mm nozzles 6 mounting ø 11mm mounting pos. upper complete with nozzle		
		Part No.	516171
		Ref. No.	4752
	rinse arm L 460mm nozzles 6 mounting ø 11mm mounting pos. upper/lower		
accessories for	506252		
		Part No.	506251
		Ref. No.	4357
	door catch L 28mm thread M16 for ATA		

			
1			
Part No.	516226	Ref. No.	2007
description	locknut		
For models:	AL10, AL11, AL15, AL16, AL30, AL31, AL35, AL36		



1

Part No.	516128	Ref. No.	4333
description	screw connection thread M6		
For models:	AL54, AL54D, AL55, AL55D, AL55PS, AT900		



1

Part No.	506279	Ref. No.	14274
description	wash arm support		
For models:	ALP01, ALP01E, ALP01EG, ALP01G, ALP02, ALP02E, ALP02EG, ALP02G		

washing and rinsing systems (sorted by producer)

ATA



1

Part No.	516010	Ref. No.	7903
description	rinse arm L 160mm nozzles 3 mounting ø 12mm mounting pos. left		
For models:	AL07, AL07D, AL09, AL09D, AL20, AL21, AL25, AL26, AL40, AL40D, AL40E, AL40ET, AL40PS, AL41, AL41E, AL45, AL45D, AL45E, AL45ET, AL45PS, AL46, AL46E		



1

Part No.	516009	Ref. No.	7902
description	rinse arm L 160mm nozzles 3 mounting ø 12mm mounting pos. right		
For models:	AL07, AL07D, AL09, AL09D, AL20, AL21, AL25, AL26, AL40, AL40D, AL40E, AL40ET, AL40PS, AL41, AL41E, AL45, AL45D, AL45E, AL45ET, AL45PS, AL46, AL46E		



1

Part No.	517506	Ref. No.	13602
description	rinse arm L 510mm nozzles 3		
For models:	ATR161, ATR221, ATR311		



1

Part No.	517509	Ref. No.	13601
description	rinse arm L 510mm nozzles 4		
For models:	ATR161, ATR221, ATR311		

1

Part No.	516208	Ref. No.	7107
description	rinse arm mounting pos. left		
For models:	AL20, AL40, AL41, AL45, AL46		

1

Part No.	516207	Ref. No.	7106
description	rinse arm mounting pos. right		
For models:	AL10, AL20, AL40, AL41, AL45, AL46		



1

Part No.	517508	Ref. No.	13411
description	rinse arm mounting pos. upper/lower L 505mm nozzles 3		
For models:	ALC100, ATR161, ATR221, ATR311		



			
1			
Part No.	517507	Ref. No.	13410
description	rinse arm mounting pos. upper/lower L 505mm nozzles 4		
For models:	ALC100, ATR161, ATR221, ATR311		

			
1			
Part No.	516011	Ref. No.	7906
description	wash arm mounting pos. upper		
For models:	AL40, AL40D, AL40E, AL40ET, AL40PS, AL41, AL41E, AL45, AL45D, AL45E, AL45ET, AL45PS, AL46, AL46E		

			
1			
Part No.	516007	Ref. No.	7904
description	wash arm L 160mm nozzles 3 mounting ø 18mm mounting pos. lower		
For models:	AL07, AL07D, AL09, AL09D, AL10, AL11, AL15, AL16, AL20, AL21, AL25, AL26, AL40, AL40D, AL40E, AL40ET, AL40PS, AL41, AL41E, AL45, AL45D, AL45E, AL45ET, AL45PS, AL46, AL46E		

			
1			
Part No.	516012	Ref. No.	7907
description	wash arm mounting pos. upper		
For models:	AL40, AL40D, AL40E, AL40ET, AL40PS, AL41, AL41E, AL45, AL45D, AL45E, AL45ET, AL45PS, AL46, AL46E		

			
1			
Part No.	516008	Ref. No.	7905
description	wash arm L 160mm nozzles 3 mounting ø 18mm mounting pos. lower		
For models:	AL07, AL07D, AL09, AL09D, AL20, AL21, AL25, AL26, AL40, AL40D, AL40E, AL40ET, AL40PS, AL41, AL41E, AL45, AL45D, AL45E, AL45ET, AL45PS, AL46, AL46E		

			
1			
Part No.	516023	Ref. No.	7131
description	disc		
For models:	AF73, AF73PS, AF78, AF78PS, AF83, AF88, AL03, AL05, AL05D, AL07, AL07D, AL09, AL09D, AL10, AL11, AL15, AL16, AL20, AL20D, AL21, AL25, AL25D, AL26, AL30, AL31, AL35, AL36, AL40, AL40D, AL40E, AL40ET, AL40PS, AL41, AL41E, AL45, AL45D, AL45E, AL45ET, AL45PS, AL46, AL46E, AL50, AL50PS, AL54, AL54D, AL60, AL60PS, ALP42, ALP42P, ALP44...(Other models you can see in the webshop)		

			
1			
Part No.	516210	Ref. No.	7109
description	wash arm mounting pos. left		
For models:	AL20, AL40, AL41, AL45, AL46		

			
1			
Part No.	516027	Ref. No.	7135
description	disc size 3/4"		
For models:	AL03, AL05, AL05D, AL07, AL07D, AL09, AL09D, AL10, AL11, AL15, AL16, AL20, AL20D, AL21, AL25, AL25D, AL26, AL30, AL31, AL35, AL36, AL40, AL40D, AL40E, AL40ET, AL40PS, AL41, AL41E, AL45, AL45D, AL45E, AL45ET, AL45PS, AL46, AL46E, AL54, AL54D, ATR75, KYRA1, KYRA1WAG, KYRA2		

			
1			
Part No.	516209	Ref. No.	7108
description	wash arm mounting pos. right		
For models:	AL20, AL40, AL41, AL45, AL46		

			
1			
Part No.	516051	Ref. No.	7602
description	end cap		
For models:	AL20, AL30, AL31, AL35, AL36, AL40, AL41, AL45, AL46, ATR161, ATR221, ATR311		



Part No.	516050	Ref. No.	4649
description	end piece		
For models:	AF73, AF73PS, AF78, AF78PS, AF83, AF88, AL10, AL11, AL15, AL16, AL20, AL21, AL25, AL26, AL30, AL31, AL35, AL36, AL40, AL41, AL45, AL46, AL50, AL50PS, AL60, AL60PS, AT105, AT106, AT95, ATR161, ATR221, ATR311, KYRA1, KYRA1WAG, KYRA2		



Part No.	516025	Ref. No.	7133
description	nut thread 1/2"		
For models:	AF73, AF73PS, AF78, AF78PS, AF83, AF88, AL03, AL05, AL05D, AL07, AL07D, AL09, AL09D, AL10, AL11, AL15, AL16, AL20, AL20D, AL21, AL25, AL25D, AL26, AL30, AL31, AL35, AL36, AL40, AL40D, AL40E, AL40ET, AL40PS, AL41, AL41E, AL45, AL45D, AL45E, AL45ET, AL45PS, AL46, AL46E, AL50, AL50PS, AL54, AL54D, AL60, AL60PS, ALP42, ALP42P, ALP44...(Other models you can see in the webshop)		



Part No.	510177	Ref. No.	4648
description	O-ring EPDM thickness 1.78mm ID ø 7.66mm Qty 1 pcs		
For models:	AF61, AF610, AF610D, AF610PS, AF610PSW, AF610W, AF61D, AF61DPS, AF61E, AF61ED, AF61EPS, AF61EW, AF61EWP, AF61PS, AF61PSW, AF61W, AF73, AF73PS, AF78, AF78D, AF780D, AF780PS, AF780PSW, AF780W, AF78D, AF78DPS, AF78E, AF78ED, AF78EDP, AF78EPS, AF78EW, AF78EWP, AF78PS, AF78PSW, AF78W, AF83, AF88, AF880, AF88E, AF88EP, AL03, AL05, AL05D, AL07, AL07D, AL09, AL09D, AL10, AL11, AL15...(Other models you can see in the webshop)		



Part No.	528223	Ref. No.	7130
description	O-ring EPDM thickness 2.62mm ID ø 11.91mm Qty 1 pcs		
For models:	AF73, AF73PS, AF78, AF78PS, AF83, AF88, AL03, AL05, AL05D, AL07, AL07D, AL09, AL09D, AL10, AL11, AL15, AL16, AL20, AL20D, AL21, AL25, AL25D, AL26, AL30, AL31, AL35, AL36, AL40, AL40D, AL40E, AL40ET, AL40PS, AL41, AL41E, AL45, AL45D, AL45E, AL45ET, AL45PS, AL46, AL46E, AL50, AL50PS, AL54, AL54D, AL60, AL60PS, ALC100, ALP01, ALP01E...(Other models you can see in the webshop)		



Part No.	516026	Ref. No.	7134
description	O-ring EPDM thickness 2.62mm ID ø 17.86mm Qty 1 pcs		
For models:	AL03, AL05, AL05D, AL07, AL07D, AL09, AL09D, AL10, AL11, AL15, AL16, AL20, AL20D, AL21, AL25, AL25D, AL26, AL30, AL31, AL35, AL36, AL40, AL40D, AL40E, AL40ET, AL40PS, AL41, AL41E, AL45, AL45D, AL45E, AL45ET, AL45PS, AL46, AL46E, AL54, AL54D, ALC100, ALP01, ALP01E, ATR161, ATR221, ATR311, KYRA1, KYRA1WAG, KYRA2		



Part No.	516024	Ref. No.	7132
description	ring		
For models:	AF73, AF73PS, AF78, AF78PS, AF83, AF88, AL03, AL05, AL05D, AL07, AL07D, AL09, AL09D, AL10, AL11, AL15, AL16, AL20, AL20D, AL21, AL25, AL25D, AL26, AL30, AL31, AL35, AL36, AL40, AL40D, AL40E, AL40ET, AL40PS, AL41, AL41E, AL45, AL45D, AL45E, AL45ET, AL45PS, AL46, AL46E, AL50, AL50PS, AL54, AL54D, AL60, AL60PS, ALP42, ALP42P, ALP44...(Other models you can see in the webshop)		



Part No.	516028	Ref. No.	7136
description	ring mounting measurements 19.5x24.5x2.6mm open		
For models:	AL03, AL05, AL05D, AL07, AL07D, AL09, AL09D, AL10, AL11, AL15, AL16, AL20, AL20D, AL21, AL25, AL25D, AL26, AL30, AL31, AL35, AL36, AL40, AL40D, AL40E, AL40ET, AL40PS, AL41, AL41E, AL45, AL45D, AL45E, AL45ET, AL45PS, AL46, AL46E, AL54, AL54D, KYRA1, KYRA1WAG, KYRA2		



Part No.	510174	Ref. No.	6831 7128
description	rinse jet		
For models:	AF61, AF610, AF610D, AF610PS, AF610PSW, AF610W, AF61D, AF61DPS, AF61E, AF61ED, AF61EPS, AF61EW, AF61EWP, AF61PS, AF61PSW, AF61W, AF73, AF73PS, AF78, AF78D, AF780D, AF780PS, AF780PSW, AF780W, AF78D, AF78DPS, AF78E, AF78ED, AF78EDP, AF78EPS, AF78EW, AF78EWP, AF78PS, AF78PSW, AF78W, AF83, AF88, AF880, AF88E, AF88EP, AL03, AL05, AL05D, AL07, AL07D, AL09, AL09D, AL10, AL11, AL15...(Other models you can see in the webshop)		





Part No.	510175	Ref. No.	6830 7127
description	rinse jet holder		
For models:	AF61, AF610, AF610D, AF610PS, AF610W, AF61D, AF61DPS, AF61E, AF61ED, AF61EPS, AF61EW, AF61EWP, AF61PS, AF61PSW, AF61W, AF73, AF73PS, AF78, AF78D, AF780D, AF780PS, AF780PSW, AF780W, AF78D, AF78DPS, AF78E, AF78ED, AF78EDP, AF78EPS, AF78EW, AF78EWP, AF78PS, AF78PSW, AF78W, AF83, AF88, AF880, AF88E, AF88EP, AL03, AL05, AL05D, AL07, AL07D, AL09, AL09D, AL10, AL11, AL15, AL16...(Other models you can see in the webshop)		
accessories for	510175		
	Part No.	560098	Ref. No. —
	sheet metal screws ø 3.5mm L 9.5mm SS Qty 20 pcs DIN 7981/ ISO 7049 head ø 6.9mm oval head		





Part No.	516144	Ref. No.	7114
description	rinse jet holder		
For models:	AL10, AL11, AL15, AL16, AL30, AL31, AL35, AL36, AL40, AL41, AL45, AL46		





 <p>1</p>			
Part No.	510173	Ref. No.	6832 7129
description	union nut for rinse jet		
For models:	AF61, AF610, AF610D, AF610PS, AF610PSW, AF610W, AF61D, AF61DPS, AF61E, AF61ED, AF61EPS, AF61EW, AF61EWP, AF61PS, AF61PSW, AF61W, AF73, AF73PS, AF78, AF780, AF780D, AF780PS, AF780PSW, AF780W, AF78D, AF78DPS, AF78E, AF78ED, AF78EDP, AF78EPS, AF78EW, AF78EWP, AF78PS, AF78PSW, AF78W, AF83, AF88, AF880, AF88E, AF88EP, AL03, AL05, AL05D, AL07, AL07D, AL09, AL09D, AL10, AL11, AL15...(Other models you can see in the webshop)		

 <p>1</p>			
Part No.	516029	Ref. No.	7137
description	union nut thread 3/4"		
For models:	AL03, AL05, AL05D, AL07, AL07D, AL09, AL09D, AL10, AL11, AL15, AL16, AL20, AL20D, AL21, AL25, AL25D, AL26, AL30, AL31, AL35, AL36, AL40, AL40D, AL40E, AL40ET, AL40PS, AL41, AL41E, AL45, AL45D, AL45E, AL45ET, AL45PS, AL46, AL46E, AL54, AL54D, KYRA1		

 <p>1</p>			
Part No.	516160	Ref. No.	7105 7429
description	wash arm boss		
For models:	AL03, AL05, AL05D, AL07, AL07D, AL09, AL09D, AL20, AL20D, AL21, AL25, AL25D, AL26, AL40, AL40D, AL40E, AL40ET, AL40PS, AL41, AL41E, AL45, AL45D, AL45E, AL45ET, AL45PS, AL46, AL46E, AL54, AL54D		

 <p>1</p>			
Part No.	516020	Ref. No.	7117
description	wash jet		
For models:	AL07, AL07D, AL09, AL09D, AL10, AL20, AL21, AL25, AL26, AL40, AL40ET, AL41, AL45, AL45ET, AL46, ALC100, ATR161, ATR221, ATR311		

 <p>1</p>			
Part No.	516201	Ref. No.	6829
description	wash jet		
For models:	AL10, AL11, AL15, AL16, AL20, AL20D, AL25, AL25D, AL40, AL40D, AL40E, AL40PS, AL41E, AL45, AL45D, AL45E, AL45PS, AL46E, ALP01, ALP01E, ATR100, ATR130, ATR130ED, ATR160, ATR190AED		
accessories for	516201		
	Part No.	504512	Ref. No. 7601
	 <p>O-ring EPDM thickness 1.78mm ID ø 14mm Qty 1 pcs</p>		

 <p>1</p>			
Part No.	516159	Ref. No.	7421
description	rinse arm L 190mm nozzles 3 mounting ø 12mm mounting pos. left		
For models:	AL54, AL54D		

 <p>1</p>			
Part No.	516158	Ref. No.	7420
description	rinse arm L 190mm nozzles 3 mounting ø 12mm mounting pos. right		
For models:	AL54, AL54D		

 <p>1</p>			
Part No.	516157	Ref. No.	7419
description	wash arm L 185mm nozzles 3 mounting ø 18mm mounting pos. left		
For models:	AL54, AL54D		

 <p>1</p>			
Part No.	516156	Ref. No.	7418
description	wash arm L 185mm nozzles 3 mounting ø 18mm mounting pos. right		
For models:	AL54, AL54D		

 <p>1</p>			
Part No.	516023	Ref. No.	7131
description	disc		
For models:	AF73, AF73PS, AF78, AF78PS, AF83, AF88, AL03, AL05, AL05D, AL07, AL07D, AL09, AL09D, AL10, AL11, AL15, AL16, AL20, AL20D, AL21, AL25, AL25D, AL26, AL30, AL31, AL35, AL36, AL40, AL40D, AL40E, AL40ET, AL40PS, AL41, AL41E, AL45, AL45D, AL45E, AL45ET, AL45PS, AL46, AL46E, AL50, AL50PS, AL54, AL54D, AL60, AL60PS, ALP42, ALP42P, ALP44...(Other models you can see in the webshop)		





			
1			
Part No.	516027	Ref. No.	7135
description	disc size 3/4"		
For models:	AL03, AL05, AL05D, AL07, AL07D, AL09, AL09D, AL10, AL11, AL15, AL16, AL20, AL20D, AL21, AL25, AL25D, AL26, AL30, AL31, AL35, AL36, AL40, AL40D, AL40E, AL40ET, AL40PS, AL41, AL41E, AL45, AL45D, AL45E, AL45ET, AL45PS, AL46, AL46E, AL54, AL54D, ATR75, KYRA1, KYRA1WAG, KYRA2		

			
1			
Part No.	516025	Ref. No.	7133
description	nut thread 1/2"		
For models:	AF73, AF73PS, AF78, AF78PS, AF83, AF88, AL03, AL05, AL05D, AL07, AL07D, AL09, AL09D, AL10, AL11, AL15, AL16, AL20, AL20D, AL21, AL25, AL25D, AL26, AL30, AL31, AL35, AL36, AL40, AL40D, AL40E, AL40ET, AL40PS, AL41, AL41E, AL45, AL45D, AL45E, AL45ET, AL45PS, AL46, AL46E, AL50, AL50PS, AL54, AL54D, AL60, AL60PS, ALP42, ALP42P, ALP44...(Other models you can see in the webshop)		

			
1			
Part No.	510177	Ref. No.	4648
description	O-ring EPDM thickness 1.78mm ID ø 7.66mm Qty 1 pcs		
For models:	AF61, AF610, AF610D, AF610PS, AF610PSW, AF610W, AF61D, AF61DPS, AF61E, AF61ED, AF61EPS, AF61EW, AF61EWP, AF61PS, AF61PSW, AF61W, AF73, AF73PS, AF78, AF780, AF780D, AF780PS, AF780PSW, AF780W, AF78D, AF78DPS, AF78E, AF78ED, AF78EDP, AF78EPS, AF78EW, AF78EWP, AF78PS, AF78PSW, AF78W, AF83, AF88, AF880, AF88E, AF88EP, AL03, AL05, AL05D, AL07, AL07D, AL09, AL09D, AL10, AL11, AL15...(Other models you can see in the webshop)		



			
1			
Part No.	528223	Ref. No.	7130
description	O-ring EPDM thickness 2.62mm ID ø 11.91mm Qty 1 pcs		
For models:	AF73, AF73PS, AF78, AF78PS, AF83, AF88, AL03, AL05, AL05D, AL07, AL07D, AL09, AL09D, AL10, AL11, AL15, AL16, AL20, AL20D, AL21, AL25, AL25D, AL26, AL30, AL31, AL35, AL36, AL40, AL40D, AL40E, AL40ET, AL40PS, AL41, AL41E, AL45, AL45D, AL45E, AL45ET, AL45PS, AL46, AL46E, AL50, AL50PS, AL54, AL54D, AL60, AL60PS, ALC100, ALP01, ALP01E...(Other models you can see in the webshop)		

			
1			
Part No.	516026	Ref. No.	7134
description	O-ring EPDM thickness 2.62mm ID ø 17.86mm Qty 1 pcs		
For models:	AL03, AL05, AL05D, AL07, AL07D, AL09, AL09D, AL10, AL11, AL15, AL16, AL20, AL20D, AL21, AL25, AL25D, AL26, AL30, AL31, AL35, AL36, AL40, AL40D, AL40E, AL40ET, AL40PS, AL41, AL41E, AL45, AL45D, AL45E, AL45ET, AL45PS, AL46, AL46E, AL54, AL54D, ALC100, ALP01, ALP01E, ATR161, ATR221, ATR311, KYRA1, KYRA1WAG, KYRA2		

			
1			
Part No.	516024	Ref. No.	7132
description	ring		
For models:	AF73, AF73PS, AF78, AF78PS, AF83, AF88, AL03, AL05, AL05D, AL07, AL07D, AL09, AL09D, AL10, AL11, AL15, AL16, AL20, AL20D, AL21, AL25, AL25D, AL26, AL30, AL31, AL35, AL36, AL40, AL40D, AL40E, AL40ET, AL40PS, AL41, AL41E, AL45, AL45D, AL45E, AL45ET, AL45PS, AL46, AL46E, AL50, AL50PS, AL54, AL54D, AL60, AL60PS, ALP42, ALP42P, ALP44...(Other models you can see in the webshop)		

			
1			
Part No.	516028	Ref. No.	7136
description	ring mounting measurements 19.5x24.5x2.6mm open		
For models:	AL03, AL05, AL05D, AL07, AL07D, AL09, AL09D, AL10, AL11, AL15, AL16, AL20, AL20D, AL21, AL25, AL25D, AL26, AL30, AL31, AL35, AL36, AL40, AL40D, AL40E, AL40ET, AL40PS, AL41, AL41E, AL45, AL45D, AL45E, AL45ET, AL45PS, AL46, AL46E, AL54, AL54D, KYRA1, KYRA1WAG, KYRA2		

			
1			
Part No.	510174	Ref. No.	6831 7128
description	rinse jet		
For models:	AF61, AF610, AF610D, AF610PS, AF610PSW, AF610W, AF61D, AF61DPS, AF61E, AF61ED, AF61EPS, AF61EW, AF61EWP, AF61PS, AF61PSW, AF61W, AF73, AF73PS, AF78, AF780, AF780D, AF780PS, AF780PSW, AF780W, AF78D, AF78DPS, AF78E, AF78ED, AF78EDP, AF78EPS, AF78EW, AF78EWP, AF78PS, AF78PSW, AF78W, AF83, AF88, AF880, AF88E, AF88EP, AL03, AL05, AL05D, AL07, AL07D, AL09, AL09D, AL10, AL11, AL15...(Other models you can see in the webshop)		

			
1			
Part No.	510175	Ref. No.	6830 7127
description	rinse jet holder		
For models:	AF61, AF610, AF610D, AF610PS, AF610W, AF61D, AF61DPS, AF61E, AF61ED, AF61EPS, AF61EW, AF61EWP, AF61PS, AF61PSW, AF61W, AF73, AF73PS, AF78, AF780, AF780D, AF780PS, AF780PSW, AF780W, AF78D, AF78DPS, AF78E, AF78ED, AF78EDP, AF78EPS, AF78EW, AF78EWP, AF78PS, AF78PSW, AF78W, AF83, AF88, AF880, AF88E, AF88EP, AL03, AL05, AL05D, AL07, AL07D, AL09, AL09D, AL10, AL11, AL15, AL16...(Other models you can see in the webshop)		
accessories for	510175		
	Part No.	560098	Ref. No. —
	sheet metal screws ø 3.5mm L 9.5mm SS Qty 20 pcs DIN 7981/ISO 7049 head ø 6.9mm oval head		





 <p>1</p>			
Part No.	510173	Ref. No.	6832 7129
description	union nut for rinse jet		
For models:	AF61, AF610, AF610D, AF610PS, AF610PSW, AF610W, AF61D, AF61DPS, AF61E, AF61ED, AF61EPS, AF61EW, AF61EWP, AF61PS, AF61PSW, AF61W, AF73, AF73PS, AF78, AF780, AF780D, AF780PS, AF780PSW, AF780W, AF78D, AF78DPS, AF78E, AF78ED, AF78EDP, AF78EPS, AF78EW, AF78EWP, AF78PS, AF78PSW, AF78W, AF83, AF88, AF880, AF88E, AF88EP, AL03, AL05, AL05D, AL07, AL07D, AL09, AL09D, AL10, AL11, AL15...(Other models you can see in the webshop)		

 <p>1</p>			
Part No.	516150	Ref. No.	7368
description	rinse arm L 145mm nozzles 3 mounting ø 12mm mounting pos. right		
For models:	AL03, AL05, AL05D		

 <p>2</p>			
Part No.	516029	Ref. No.	7137
description	union nut thread 3/4"		
For models:	AL03, AL05, AL05D, AL07, AL07D, AL09, AL09D, AL10, AL11, AL15, AL16, AL20, AL20D, AL21, AL25, AL25D, AL26, AL30, AL31, AL35, AL36, AL40, AL40D, AL40E, AL40ET, AL40PS, AL41, AL41E, AL45, AL45D, AL45E, AL45ET, AL45PS, AL46, AL46E, AL54, AL54D, KYRA1		

 <p>1</p>			
Part No.	516239	Ref. No.	7352
description	wash arm L 145mm nozzles 3 mounting ø 18mm mounting pos. left		
For models:	AL03, AL05, AL05D		

 <p>1</p>			
Part No.	516160	Ref. No.	7105 7429
description	wash arm boss		
For models:	AL03, AL05, AL05D, AL07, AL07D, AL09, AL09D, AL20, AL20D, AL21, AL25, AL25D, AL26, AL40, AL40D, AL40E, AL40ET, AL40PS, AL41, AL41E, AL45, AL45D, AL45E, AL45ET, AL45PS, AL46, AL46E, AL54, AL54D		

 <p>1</p>			
Part No.	516152	Ref. No.	7370
description	wash arm L 145mm nozzles 3 mounting ø 18mm mounting pos. right		
For models:	AL03, AL05, AL05D		

 <p>1</p>			
Part No.	516199	Ref. No.	7356A
description	wash jet inclination 15° mounting pos. right		
For models:	AL03, AL05, AL05D, AL11, AL15, AL16, AL30, AL31, AL35, AL36, AL40, AL40E, AL40PS, AL41, AL41E, AL45, AL45E, AL45PS, AL46, AL46E, AL54, AL54D, ALP01, ALP01E, ALP42, ALP42P, ALP44, ALP44P		

 <p>1</p>			
Part No.	516023	Ref. No.	7131
description	disc		
For models:	AF73, AF73PS, AF78, AF78PS, AF83, AF88, AL03, AL05, AL05D, AL07, AL07D, AL09, AL09D, AL10, AL11, AL15, AL16, AL20, AL20D, AL21, AL25, AL25D, AL26, AL30, AL31, AL35, AL36, AL40, AL40D, AL40E, AL40ET, AL40PS, AL41, AL41E, AL45, AL45D, AL45E, AL45ET, AL45PS, AL46, AL46E, AL50, AL50PS, AL54, AL54D, AL60, AL60PS, ALP42, ALP42P, ALP44...(Other models you can see in the webshop)		

 <p>1</p>			
Part No.	516151	Ref. No.	7369
description	rinse arm L 145mm nozzles 3 mounting ø 12mm mounting pos. left		
For models:	AL03, AL05, AL05D		

 <p>1</p>			
Part No.	516027	Ref. No.	7135
description	disc size 3/4"		
For models:	AL03, AL05, AL05D, AL07, AL07D, AL09, AL09D, AL10, AL11, AL15, AL16, AL20, AL20D, AL21, AL25, AL25D, AL26, AL30, AL31, AL35, AL36, AL40, AL40D, AL40E, AL40ET, AL40PS, AL41, AL41E, AL45, AL45D, AL45E, AL45ET, AL45PS, AL46, AL46E, AL54, AL54D, ATR75, KYRA1, KYRA1WAG, KYRA2		





			
1			
Part No.	516025	Ref. No.	7133
description	nut thread 1/2"		
For models:	AF73, AF73PS, AF78, AF78PS, AF83, AF88, AL03, AL05, AL05D, AL07, AL07D, AL09, AL09D, AL10, AL11, AL15, AL16, AL20, AL20D, AL21, AL25, AL25D, AL26, AL30, AL31, AL35, AL36, AL40, AL40D, AL40E, AL40ET, AL40PS, AL41, AL41E, AL45, AL45D, AL45E, AL45ET, AL45PS, AL46, AL46E, AL50, AL50PS, AL54, AL54D, AL60, AL60PS, ALP42, ALP42P, ALP44...(Other models you can see in the webshop)		

			
1			
Part No.	510177	Ref. No.	4648
description	O-ring EPDM thickness 1.78mm ID ø 7.66mm Qty 1 pcs		
For models:	AF61, AF610, AF610D, AF610PS, AF610PSW, AF610W, AF61D, AF61DPS, AF61E, AF61ED, AF61EPS, AF61EW, AF61EWP, AF61PS, AF61PSW, AF61W, AF73, AF73PS, AF78, AF780, AF780D, AF780PS, AF780PSW, AF780W, AF78D, AF78DPS, AF78E, AF78ED, AF78EDP, AF78EPS, AF78EW, AF78EWP, AF78PS, AF78PSW, AF78W, AF83, AF88, AF880, AF88E, AF88EP, AL03, AL05, AL05D, AL07, AL07D, AL09, AL09D, AL10, AL11, AL15...(Other models you can see in the webshop)		



			
1			
Part No.	528223	Ref. No.	7130
description	O-ring EPDM thickness 2.62mm ID ø 11.91mm Qty 1 pcs		
For models:	AF73, AF73PS, AF78, AF78PS, AF83, AF88, AL03, AL05, AL05D, AL07, AL07D, AL09, AL09D, AL10, AL11, AL15, AL16, AL20, AL20D, AL21, AL25, AL25D, AL26, AL30, AL31, AL35, AL36, AL40, AL40D, AL40E, AL40ET, AL40PS, AL41, AL41E, AL45, AL45D, AL45E, AL45ET, AL45PS, AL46, AL46E, AL50, AL50PS, AL54, AL54D, AL60, AL60PS, ALC100, ALP01, ALP01E...(Other models you can see in the webshop)		

			
1			
Part No.	516026	Ref. No.	7134
description	O-ring EPDM thickness 2.62mm ID ø 17.86mm Qty 1 pcs		
For models:	AL03, AL05, AL05D, AL07, AL07D, AL09, AL09D, AL10, AL11, AL15, AL16, AL20, AL20D, AL21, AL25, AL25D, AL26, AL30, AL31, AL35, AL36, AL40, AL40D, AL40E, AL40ET, AL40PS, AL41, AL41E, AL45, AL45D, AL45E, AL45ET, AL45PS, AL46, AL46E, AL54, AL54D, ALC100, ALP01, ALP01E, ATR161, ATR221, ATR311, KYRA1, KYRA1WAG, KYRA2		

			
1			
Part No.	516024	Ref. No.	7132
description	ring		
For models:	AF73, AF73PS, AF78, AF78PS, AF83, AF88, AL03, AL05, AL05D, AL07, AL07D, AL09, AL09D, AL10, AL11, AL15, AL16, AL20, AL20D, AL21, AL25, AL25D, AL26, AL30, AL31, AL35, AL36, AL40, AL40D, AL40E, AL40ET, AL40PS, AL41, AL41E, AL45, AL45D, AL45E, AL45ET, AL45PS, AL46, AL46E, AL50, AL50PS, AL54, AL54D, AL60, AL60PS, ALP42, ALP42P, ALP44...(Other models you can see in the webshop)		

			
1			
Part No.	516028	Ref. No.	7136
description	ring mounting measurements 19.5x24.5x2.6mm open		
For models:	AL03, AL05, AL05D, AL07, AL07D, AL09, AL09D, AL10, AL11, AL15, AL16, AL20, AL20D, AL21, AL25, AL25D, AL26, AL30, AL31, AL35, AL36, AL40, AL40D, AL40E, AL40ET, AL40PS, AL41, AL41E, AL45, AL45D, AL45E, AL45ET, AL45PS, AL46, AL46E, AL54, AL54D, KYRA1, KYRA1WAG, KYRA2		

			
1			
Part No.	510174	Ref. No.	6831 7128
description	rinse jet		
For models:	AF61, AF610, AF610D, AF610PS, AF610PSW, AF610W, AF61D, AF61DPS, AF61E, AF61ED, AF61EPS, AF61EW, AF61EWP, AF61PS, AF61PSW, AF61W, AF73, AF73PS, AF78, AF780, AF780D, AF780PS, AF780PSW, AF780W, AF78D, AF78DPS, AF78E, AF78ED, AF78EDP, AF78EPS, AF78EW, AF78EWP, AF78PS, AF78PSW, AF78W, AF83, AF88, AF880, AF88E, AF88EP, AL03, AL05, AL05D, AL07, AL07D, AL09, AL09D, AL10, AL11, AL15...(Other models you can see in the webshop)		

			
1			
Part No.	510175	Ref. No.	6830 7127
description	rinse jet holder		
For models:	AF61, AF610, AF610D, AF610PS, AF610W, AF61D, AF61DPS, AF61E, AF61ED, AF61EPS, AF61EW, AF61EWP, AF61PS, AF61PSW, AF61W, AF73, AF73PS, AF78, AF780, AF780D, AF780PS, AF780PSW, AF780W, AF78D, AF78DPS, AF78E, AF78ED, AF78EDP, AF78EPS, AF78EW, AF78EWP, AF78PS, AF78PSW, AF78W, AF83, AF88, AF880, AF88E, AF88EP, AL03, AL05, AL05D, AL07, AL07D, AL09, AL09D, AL10, AL11, AL15, AL16...(Other models you can see in the webshop)		
accessories for	510175		
	Part No.	560098	Ref. No. —
	sheet metal screws ø 3.5mm L 9.5mm SS Qty 20 pcs DIN 7981/ ISO 7049 head ø 6.9mm oval head		

			
1			
Part No.	510173	Ref. No.	6832 7129
description	union nut for rinse jet		
For models:	AF61, AF610, AF610D, AF610PS, AF610PSW, AF610W, AF61D, AF61DPS, AF61E, AF61ED, AF61EPS, AF61EW, AF61EWP, AF61PS, AF61PSW, AF61W, AF73, AF73PS, AF78, AF780, AF780D, AF780PS, AF780PSW, AF780W, AF78D, AF78DPS, AF78E, AF78ED, AF78EDP, AF78EPS, AF78EW, AF78EWP, AF78PS, AF78PSW, AF78W, AF83, AF88, AF880, AF88E, AF88EP, AL03, AL05, AL05D, AL07, AL07D, AL09, AL09D, AL10, AL11, AL15...(Other models you can see in the webshop)		

			
1			
Part No.	516029	Ref. No.	7137
description	union nut thread 3/4"		
For models:	AL03, AL05, AL05D, AL07, AL07D, AL09, AL09D, AL10, AL11, AL15, AL16, AL20, AL20D, AL21, AL25, AL25D, AL26, AL30, AL31, AL35, AL36, AL40, AL40D, AL40E, AL40ET, AL40PS, AL41, AL41E, AL45, AL45D, AL45E, AL45ET, AL45PS, AL46, AL46E, AL54, AL54D, KYRA1		





 <p>1</p>			
Part No.	516160	Ref. No.	7105 7429
description	wash arm boss		
For models:	AL03, AL05, AL05D, AL07, AL07D, AL09, AL09D, AL20, AL20D, AL21, AL25, AL25D, AL26, AL40, AL40D, AL40E, AL40ET, AL40PS, AL41, AL41E, AL45, AL45D, AL45E, AL45ET, AL45PS, AL46, AL46E, AL54, AL54D		

 <p>1</p>			
Part No.	516149	Ref. No.	7356C
description	wash jet inclination 15° mounting pos. left		
For models:	AL03, AL05, AL05D		







 <p>1</p>			
Part No.	516199	Ref. No.	7356A
description	wash jet inclination 15° mounting pos. right		
For models:	AL03, AL05, AL05D, AL11, AL15, AL16, AL30, AL31, AL35, AL36, AL40, AL40E, AL40PS, AL41, AL41E, AL45, AL45E, AL45PS, AL46, AL46E, AL54, AL54D, ALP01, ALP01E, ALP42, ALP42P, ALP44, ALP44P		

 <p>1</p>			
Part No.	516200	Ref. No.	7356B
description	wash jet straight mounting pos. inner		
For models:	AL03, AL05, AL05D		

 <p>1</p>			
Part No.	516240	Ref. No.	5104
description	rinse arm complete		







 <p>1</p>			
Part No.	516040	Ref. No.	4628
description	rinse arm L 230mm nozzles 3 mounting ø 12mm mounting pos. left		
For models:	AF78, AF78PS, AF83, AF88, AL60, AL60PS, AT105, AT106, AT95		

 <p>1</p>			
Part No.	516039	Ref. No.	4627
description	rinse arm L 230mm nozzles 3 mounting ø 12mm mounting pos. right		
For models:	AF78, AF78PS, AF83, AF88, AL60, AL60PS, AT105, AT106, AT95		

 <p>1</p>				
Part No.	516153	Ref. No.	7381	
description	rinse arm L 370mm nozzles 6 mounting ø 11mm mounting pos. upper complete with nozzle			
For models:	AL03, AL05, AL05D, AL07, AL07D, AL09, AL09D, AL20, AL20D, AL25, AL25D			
spare parts for	516153			
	Part No.	506252	Ref. No.	4355
	knurled nut ø 32.5mm thread M16 H 7mm			
	Part No.	510173	Ref. No.	6832 7129
	union nut for rinse jet			
	Part No.	510174	Ref. No.	6831 7128
	rinse jet			
	Part No.	510175	Ref. No.	6830 7127
	rinse jet holder			
	Part No.	510177	Ref. No.	4648
	O-ring EPDM thickness 1.78mm ID ø 7.66mm Qty 1 pcs			









			
1			
Part No.	516171	Ref. No.	4752
description	rinse arm L 460mm nozzles 6 mounting \varnothing 11mm mounting pos. upper/lower		
For models:	AF61, AF610, AF610D, AF610PS, AF610PSW, AF610W, AF61D, AF61DPS, AF61E, AF61ED, AF61EPS, AF61EW, AF61EWP, AF61PS, AF61PSW, AF61W, AF78, AF78D, AF78DPS, AF78E, AF78ED, AF78EDP, AF78EPS, AF78EW, AF78EWP, AF78PS, AF78PSW, AF78W, AF88, AF88D, AF88E, AF88EP, AL55, AL55D, AL55PS, ALP33, ALP33E, AME540		
spare parts for	516171		
	Part No.	506252	Ref. No. 4355
	knurled nut \varnothing 32.5mm thread M16 H 7mm		
	Part No.	510173	Ref. No. 6832 7129
	union nut for rinse jet		
	Part No.	510174	Ref. No. 6831 7128
	rinse jet		
	Part No.	510175	Ref. No. 6830 7127
	rinse jet holder		
	Part No.	510177	Ref. No. 4648
	O-ring EPDM thickness 1.78mm ID \varnothing 7.66mm Qty 1 pcs		

			
1			
Part No.	516049	Ref. No.	9714
description	rinse arm L 510mm nozzles 6 mounting \varnothing 11mm mounting pos. upper/lower		
For models:	ALP42, ALP42P, ALP44, ALP44P, AT105, AT105E, AT110, AT110E, AT112, AT114, AT116, AT95		
spare parts for	516049		
	Part No.	510173	Ref. No. 6832 7129
	union nut for rinse jet		
	Part No.	510174	Ref. No. 6831 7128
	rinse jet		
	Part No.	510175	Ref. No. 6830 7127
	rinse jet holder		
	Part No.	510177	Ref. No. 4648
	O-ring EPDM thickness 1.78mm ID \varnothing 7.66mm Qty 1 pcs		
	Part No.	516052	Ref. No. 9621
	end cap for rinse arm		



			
1			
Part No.	517510	Ref. No.	14015
description	rinse arm mounting pos. upper/lower L 575mm nozzles 6 mounting \varnothing 15mm		
For models:	ALP01, ALP01E, ALP01EG, ALP01G, ALP02, ALP02E, ALP02EG, ALP02G		

			
1			
Part No.	516038	Ref. No.	9630+9632
description	wash arm		

			
1			
Part No.	516211	Ref. No.	4602
description	wash arm		
For models:	AF78, AF78PS, AF83, AF88, AL60, AL60PS, AT105, AT106, AT95		

			
1			
Part No.	516191	Ref. No.	9630
description	wash arm L 495mm nozzles 10 mounting \varnothing 62/16mm mounting pos. upper/lower		
For models:	AF78, AF78PS, AF88, AL60, AL60PS, ALP42, ALP42P, ALP44, ALP44P, AT105, AT105E, AT110, AT110E, AT112, AT114, AT116, AT95		
spare parts for	516191		
	Part No.	510769	Ref. No. 4615
	O-ring EPDM thickness 2.62mm ID \varnothing 25.07mm Qty 1 pcs		
	Part No.	516035	Ref. No. 4621
	rinse arm shaft		
	Part No.	516037	Ref. No. 14207 4603
	flat gasket \varnothing 20mm ID \varnothing 15mm thickness 3mm		
	Part No.	516203	Ref. No. 4609
	bush for wash arm		
accessories for	516191		
	Part No.	516048	Ref. No. 9632
	bush for wash arm H 27mm D1 \varnothing 45mm D2 \varnothing 21mm D3 \varnothing 16mm 4 hole fixing		





			
1			
Part No.	516134	Ref. No.	4365
description	wash arm L 500mm nozzles 10 mounting ø 62/16mm mounting pos. upper/lower		
For models:	AF61, AF610, AF610D, AF610PS, AF610PSW, AF610W, AF61D, AF61DPS, AF61E, AF61ED, AF61EPS, AF61EW, AF61EWP, AF61PS, AF61PSW, AF61W, AF78, AF780, AF780D, AF780PS, AF780PSW, AF780W, AF78D, AF78DPS, AF78E, AF78ED, AF78EDP, AF78EPS, AF78EW, AF78EWP, AF78PS, AF78PSW, AF78W, AF88, AF880, AF88E, AF88EP, AL55, AL55D, AL55PS, ALP33, ALP33E, ALP42, ALP42P, ALP44, ALP44P, AME540, AT900		
spare parts for	516134		
	Part No.	516048	Ref. No. 9632
	 bush for wash arm H 27mm D1 ø 45mm D2 ø 21mm D3 ø 16mm 4 hole fixing		

			
1			
Part No.	516203	Ref. No.	4609
description	bush for wash arm		
For models:	AF78, AF78PS, AF88, AL60, AL60PS		

			
1			
Part No.	516023	Ref. No.	7131
description	disc		
For models:	AF73, AF73PS, AF78, AF78PS, AF83, AF88, AL03, AL05, AL05D, AL07, AL07D, AL09, AL09D, AL10, AL11, AL15, AL16, AL20, AL20D, AL21, AL25, AL25D, AL26, AL30, AL31, AL35, AL36, AL40, AL40D, AL40E, AL40ET, AL40PS, AL41, AL41E, AL45, AL45D, AL45E, AL45ET, AL45PS, AL46, AL46E, AL50, AL50PS, AL54, AL54D, AL60, AL60PS, ALP42, ALP42P, ALP44...(Other models you can see in the webshop)		

			
1			
Part No.	516052	Ref. No.	9621
description	end cap for rinse arm		
For models:	ALP42, ALP42P, ALP44, ALP44P, AT105, AT110, AT112, AT114, AT116, AT95		

			
1			
Part No.	524825	Ref. No.	4366
description	gasket for rinse arm PTFE mounting pos. upper/lower ø 11mm ID ø 9mm thickness 1.2mm		
For models:	AF61, AF610, AF610D, AF610PS, AF610PSW, AF610W, AF61D, AF61DPS, AF61E, AF61ED, AF61EPS, AF61EW, AF61EWP, AF61PS, AF61PSW, AF61W, AF78, AF780, AF780D, AF780PS, AF780PSW, AF780W, AF78D, AF78DPS, AF78E, AF78ED, AF78EDP, AF78EPS, AF78EW, AF78EWP, AF78PS, AF78PSW, AF78W, AF88, AF880, AF88E, AF88EP, AL03, AL05, AL05D, AL07, AL07D, AL09, AL09D, AL20, AL20D, AL25, AL25D, AL55, AL55D...(Other models you can see in the webshop)		

			
1			
Part No.	516025	Ref. No.	7133
description	nut thread 1/2"		
For models:	AF73, AF73PS, AF78, AF78PS, AF83, AF88, AL03, AL05, AL05D, AL07, AL07D, AL09, AL09D, AL10, AL11, AL15, AL16, AL20, AL20D, AL21, AL25, AL25D, AL26, AL30, AL31, AL35, AL36, AL40, AL40D, AL40E, AL40ET, AL40PS, AL41, AL41E, AL45, AL45D, AL45E, AL45ET, AL45PS, AL46, AL46E, AL50, AL50PS, AL54, AL54D, AL60, AL60PS, ALP42, ALP42P, ALP44...(Other models you can see in the webshop)		

			
1			
Part No.	510177	Ref. No.	4648
description	O-ring EPDM thickness 1.78mm ID ø 7.66mm Qty 1 pcs		
For models:	AF61, AF610, AF610D, AF610PS, AF610PSW, AF610W, AF61D, AF61DPS, AF61E, AF61ED, AF61EPS, AF61EW, AF61EWP, AF61PS, AF61PSW, AF61W, AF73, AF73PS, AF78, AF780, AF780D, AF780PS, AF780PSW, AF780W, AF78D, AF78DPS, AF78E, AF78ED, AF78EDP, AF78EPS, AF78EW, AF78EWP, AF78PS, AF78PSW, AF78W, AF83, AF88, AF880, AF88E, AF88EP, AL03, AL05, AL05D, AL07, AL07D, AL09, AL09D, AL10, AL11, AL15...(Other models you can see in the webshop)		

			
1			
Part No.	528223	Ref. No.	7130
description	O-ring EPDM thickness 2.62mm ID ø 11.91mm Qty 1 pcs		
For models:	AF73, AF73PS, AF78, AF78PS, AF83, AF88, AL03, AL05, AL05D, AL07, AL07D, AL09, AL09D, AL10, AL11, AL15, AL16, AL20, AL20D, AL21, AL25, AL25D, AL26, AL30, AL31, AL35, AL36, AL40, AL40D, AL40E, AL40ET, AL40PS, AL41, AL41E, AL45, AL45D, AL45E, AL45ET, AL45PS, AL46, AL46E, AL50, AL50PS, AL54, AL54D, AL60, AL60PS, ALC100, ALP01, ALP01E...(Other models you can see in the webshop)		

			
1			
Part No.	516024	Ref. No.	7132
description	ring		
For models:	AF73, AF73PS, AF78, AF78PS, AF83, AF88, AL03, AL05, AL05D, AL07, AL07D, AL09, AL09D, AL10, AL11, AL15, AL16, AL20, AL20D, AL21, AL25, AL25D, AL26, AL30, AL31, AL35, AL36, AL40, AL40D, AL40E, AL40ET, AL40PS, AL41, AL41E, AL45, AL45D, AL45E, AL45ET, AL45PS, AL46, AL46E, AL50, AL50PS, AL54, AL54D, AL60, AL60PS, ALP42, ALP42P, ALP44...(Other models you can see in the webshop)		



			
1			
Part No.	516043	Ref. No.	4622
description	rinse arm boss		
For models:	AF78, AF78PS, AF83, AF88, AL60, AL60PS, AT105, AT106, AT95		

mechanical components,
equipment accessories

1





			
1			
Part No.	510174	Ref. No.	6831 7128
description	rinse jet		
For models:	AF61, AF610, AF610D, AF610PS, AF610PSW, AF610W, AF61D, AF61DPS, AF61E, AF61ED, AF61EPS, AF61EW, AF61EWP, AF61PS, AF61PSW, AF61W, AF73, AF73PS, AF78, AF780, AF780D, AF780PS, AF780PSW, AF780W, AF78D, AF78DPS, AF78E, AF78ED, AF78EDP, AF78EPS, AF78EW, AF78EWP, AF78PS, AF78PSW, AF78W, AF83, AF88, AF880, AF88E, AF88EP, AL03, AL05, AL05D, AL07, AL07D, AL09, AL09D, AL10, AL11, AL15...(Other models you can see in the webshop)		

			
2			
Part No.	510175	Ref. No.	6830 7127
description	rinse jet holder		
For models:	AF61, AF610, AF610D, AF610PS, AF610W, AF61D, AF61DPS, AF61E, AF61ED, AF61EPS, AF61EW, AF61EWP, AF61PS, AF61PSW, AF61W, AF73, AF73PS, AF78, AF780, AF780D, AF780PS, AF780PSW, AF780W, AF78D, AF78DPS, AF78E, AF78ED, AF78EDP, AF78EPS, AF78EW, AF78EWP, AF78PS, AF78PSW, AF78W, AF83, AF88, AF880, AF88E, AF88EP, AL03, AL05, AL05D, AL07, AL07D, AL09, AL09D, AL10, AL11, AL15, AL16...(Other models you can see in the webshop)		
accessories for	510175		
	Part No.	560098	Ref. No. —
	sheet metal screws \varnothing 3.5mm L 9.5mm SS Qty 20 pcs DIN 7981/ISO 7049 head \varnothing 6.9mm oval head		

			
1			
Part No.	516036	Ref. No.	4625
description	spindle for wash arm		
For models:	AF78, AF78PS, AF83, AF88, AL60, AL60PS, AT105, AT106, AT95		

			
1			
Part No.	510173	Ref. No.	6832 7129
description	union nut for rinse jet		
For models:	AF61, AF610, AF610D, AF610PS, AF610PSW, AF610W, AF61D, AF61DPS, AF61E, AF61ED, AF61EPS, AF61EW, AF61EWP, AF61PS, AF61PSW, AF61W, AF73, AF73PS, AF78, AF780, AF780D, AF780PS, AF780PSW, AF780W, AF78D, AF78DPS, AF78E, AF78ED, AF78EDP, AF78EPS, AF78EW, AF78EWP, AF78PS, AF78PSW, AF78W, AF83, AF88, AF880, AF88E, AF88EP, AL03, AL05, AL05D, AL07, AL07D, AL09, AL09D, AL10, AL11, AL15...(Other models you can see in the webshop)		

miscellaneous			
			
1			
Part No.	516121	Ref. No.	4114
description	nozzle holder		
For models:	AF73, AF73PS, AF78PS, AL50, AL50PS		

			
1			
Part No.	510186	Ref. No.	1001
description	rinse jet		
For models:	AF73, AF73PS, AF78, AF78PS, AF83, AF88, AL20, AL21, AL25, AL26, AL30, AL31, AL35, AL36, AL40, AL41, AL45, AL46, AL50, AL50PS, AL60, AL60PS, AT105, AT106, AT95		

			
1			
Part No.	510176	Ref. No.	7116
description	rinse jet holder		
For models:	AF73, AF73PS, AF78, AF78PS, AF83, AF88, AL20, AL21, AL25, AL26, AL30, AL31, AL35, AL36, AL40, AL41, AL45, AL46, AL50, AL50PS, AL60, AL60PS, AT105, AT106, AT95		

			
1			
Part No.	510187	Ref. No.	1000
description	swirl H 8mm \varnothing 10mm		
For models:	AF73, AF73PS, AF78, AF78PS, AF83, AF88, AL20, AL21, AL25, AL26, AL30, AL31, AL35, AL36, AL40, AL41, AL45, AL46, AL50, AL50PS, AL60, AL60PS, AT105, AT106, AT95		

			
1			
Part No.	516107	Ref. No.	1002
description	swirl hole \varnothing 2mm H 4mm \varnothing 18mm 4mm		
For models:	AL10, AL11, AL15, AL16, AL30, AL31, AL35, AL36, AL40, AL41, AL45, AL46		

			
1			
Part No.	516108	Ref. No.	1003
description	wash jet		
For models:	AF73, AF73PS, AF83, AL10, AL11, AL15, AL16, AL30, AL31, AL35, AL36, AL40, AL41, AL45, AL46, AL50, AL50PS		





			
1			
Part No.	516117	Ref. No.	4103
description	wash jet		
For models:	AF73, AF73PS, AF78PS, AF83, AL50, AL50PS		

			
1			
Part No.	516099	Ref. No.	6801
description	pillar for wash arm support mounting pos. lower ø 50mm H 85mm		
For models:	AL20, AL20D, AL25, AL25D, AL40, AL402, AL40D, AL40E, AL40PS, AL41E, AL45, AL45D, AL45E, AL45PS, AL46E		

wash arm supports

			
1			
Part No.	516137	Ref. No.	4369
description	opposite support mounting pos. lower for wash arm support		
For models:	AF55, AF61, AF610, AF610D, AF610PS, AF610PSW, AF610W, AF61D, AF61DPS, AF61E, AF61EPS, AF61EW, AF61EWP, AF61PS, AF61PSW, AF61W, AF78, AF780, AF780D, AF780PS, AF780PSW, AF780W, AF78D, AF78DPS, AF78E, AF78ED, AF78EDP, AF78EPS, AF78EW, AF78EWP, AF78PS, AF78PSW, AF78W, AF88, AF880, AF88E, AF88EP, AL40, AL40D, AL40E, AL40PS, AL45, AL45D, AL45E, AL45PS, AL54, AL54D, AL55, AL55D, AL55PS...(Other models you can see in the webshop)		
accessories for	516137		
	Part No.	516141	Ref. No. 4391
	gasket D1 ø 40mm D2 ø 71mm thickness 2mm with 4 screw holes wash arm support equiv. no. 4391 suitable for ATA		
	Part No.	516266	Ref. No. 6802
	pillar for wash arm support mounting pos. lower D1 ø 50mm D2 ø 56mm D3 ø 74mm H 110mm		

			
1			
Part No.	516000	Ref. No.	7100
description	wash arm support		
For models:	AL07, AL07D, AL09, AL09D, AL20, AL21, AL25, AL26, AL40, AL40ET, AL40PS, AL41, AL41E, AL45, AL45ET, AL45PS, AL46, AL46E		

			
1			
Part No.	516130	Ref. No.	4341
description	wash arm support		
For models:	AL55, AL55D, AL55PS, AT900		

			
1			
Part No.	516122	Ref. No.	4115
description	wash arm support for round basket		
For models:	AF73, AF73PS, AF78PS, AL50, AL50PS		



			
1			
Part No.	516245	Ref. No.	4345
description	pillar for wash arm support mounting pos. lower		
For models:	AL55		

			
1			
Part No.	516266	Ref. No.	6802
description	pillar for wash arm support mounting pos. lower D1 ø 50mm D2 ø 56mm D3 ø 74mm H 110mm		
For models:	AF55, AL54, AL54D		

			
1			
Part No.	516132	Ref. No.	4362
description	wash arm support mounting pos. lower		
For models:	AF61, AF610, AF610D, AF610PS, AF610PSW, AF610W, AF61D, AF61DPS, AF61E, AF61ED, AF61EPS, AF61EW, AF61EWP, AF61PS, AF61PSW, AF61W, AF78, AF780, AF780D, AF780PS, AF780PSW, AF780W, AF78D, AF78DPS, AF78E, AF78ED, AF78EDP, AF78EPS, AF78EW, AF78EWP, AF78PS, AF78PSW, AF78W, AF88, AF880, AF88E, AF88EP, ALP33, ALP33E, AME540		





			
1			
Part No.	516019	Ref. No.	7914
description	wash arm support mounting pos. upper		
For models:	AL40, AL40E, AL40ET, AL40PS, AL41, AL41E, AL45, AL45E, AL45ET, AL45PS, AL46, AL46E		

			
1			
Part No.	516172	Ref. No.	4756
description	wash arm support mounting pos. upper		
For models:	AF61, AF610, AF610D, AF610PS, AF610PSW, AF610W, AF61D, AF61DPS, AF61E, AF61ED, AF61EPS, AF61EW, AF61EWP, AF61PS, AF61PSW, AF61W, AF78, AF780, AF780D, AF780PS, AF780PSW, AF780W, AF78D, AF78DPS, AF78E, AF78ED, AF78EDP, AF78EPS, AF78EW, AF78EWP, AF78PS, AF78PSW, AF78W, AF88, AF880, AF88E, AF88EP, AL55, AL55D, AL55PS, ALP33, ALP33E, AME540		
accessories for	516172		
	Part No.	516001	Ref. No. 7138
	gasket D1 ø 61mm D2 ø 90mm thickness 2mm with 4 screw holes wash arm support equiv. no. 7138 suitable for ATA		

			
1			
Part No.	516183	Ref. No.	6804
description	wash arm support mounting pos. upper		
For models:	AF55, AL03, AL05, AL40, AL402, AL40D, AL40E, AL40PS, AL45, AL45D, AL45E, AL45PS, AL54, AL54D		

			
1			
Part No.	516238	Ref. No.	4759
description	wash arm support mounting pos. upper		
For models:	AL54, AL54D		

			
1			
Part No.	516140	Ref. No.	4375
description	wash arm support mounting pos. upper/lower ø 59mm ID ø 45mm flange ø 90mm thread M10x1 H 45mm hose ø 11/23mm		
For models:	AL03, AL05, AL05D		

			
1			
Part No.	516262	Ref. No.	9601
description	wash arm support mounting pos. upper/lower ø 70mm		
For models:	ALP42, ALP42P, ALP44, ALP44P, AT105, AT105E, AT110, AT110E, AT112, AT114, AT116, AT900, AT95		

			
1			
Part No.	516118	Ref. No.	4104
description	gasket D1 ø 120mm D2 ø 56mm thickness 3mm with 4 screw holes equiv. no. 4104 suitable for ATA		
For models:	AF73, AF73PS, AF83, AL50, AL50PS		

			
1			
Part No.	516141	Ref. No.	4391
description	gasket D1 ø 40mm D2 ø 71mm thickness 2mm with 4 screw holes wash arm support equiv. no. 4391 suitable for ATA		
For models:	AF55, AF61, AF610, AF610D, AF610PS, AF610PSW, AF610W, AF61D, AF61DPS, AF61E, AF61ED, AF61EPS, AF61EW, AF61EWP, AF61PS, AF61PSW, AF61W, AF78, AF780, AF780D, AF780PS, AF780PSW, AF780W, AF78D, AF78DPS, AF78E, AF78ED, AF78EDP, AF78EPS, AF78EW, AF78EWP, AF78PS, AF78PSW, AF78W, AF88, AF880, AF88E, AF88EP, AL20, AL20D, AL25, AL25D, AL40, AL402, AL40D, AL40E, AL40PS, AL41E, AL45, AL45D...(Other models you can see in the webshop)		

			
1			
Part No.	516031	Ref. No.	4619
description	gasket D1 ø 40mm D2 ø 72mm thickness 2mm with 4 screw holes wash arm support		
For models:	AF73, AF73PS, AF78, AF78PS, AF83, AF88, AL50, AL50PS, AL60, AL60PS, ALP01, ALP02, AT105, AT106, AT95		

			
1			
Part No.	516184	Ref. No.	6810
description	gasket D1 ø 50mm D2 ø 90mm thickness 2mm rubber with 4 screw holes wash arm support equiv. no. 6810 suitable for ATA		
For models:	AL03, AL05, AL40, AL402, AL40D, AL40E, AL40PS, AL45, AL45D, AL45E, AL45PS		





			
1			
Part No.	516001	Ref. No.	7138
description	gasket D1 ø 61mm D2 ø 90mm thickness 2mm with 4 screw holes wash arm support equiv. no. 7138 suitable for ATA		
For models:	AF55, AF61, AF610, AF610D, AF610PS, AF610PSW, AF610W, AF61D, AF61DPS, AF61E, AF61ED, AF61EPS, AF61EW, AF61EWP, AF61PS, AF-61PSW, AF61W, AF78, AF780, AF780D, AF780PS, AF780PSW, AF780W, AF78D, AF78DPS, AF78E, AF78ED, AF78EDP, AF78EPS, AF78EWP, AF78PS, AF78PSW, AF78W, AF88, AF880, AF88E, AF88EP, AL03, AL05, AL05D, AL07, AL07D, AL09, AL09D, AL10, AL11, AL15, AL16, AL20...(Other models you can see in the webshop)		

			
2			
Part No.	516133	Ref. No.	4364
description	gasket for wash arm PTFE		
For models:	AF61, AF610, AF610D, AF610PS, AF610PSW, AF610W, AF61D, AF61DPS, AF61E, AF61ED, AF61EPS, AF61EW, AF61EWP, AF61PS, AF61PSW, AF61W, AF78, AF780, AF780D, AF780PS, AF780PSW, AF780W, AF78D, AF78DPS, AF78E, AF78ED, AF78EDP, AF78EPS, AF78EWP, AF78PS, AF78PSW, AF78W, AF88, AF880, AF88E, AF88EP, AL55, AL55D, AL55PS, ALP33, ALP33E, AME540, AT900		

			
1			
Part No.	510769	Ref. No.	4615
description	O-ring EPDM thickness 2.62mm ID ø 25.07mm Qty 1 pcs		
For models:	AF78, AF78PS, AF83, AF88, AL03, AL05, AL05D, AL31, AL36, AL41, AL41E, AL46, AL46E, AL60, AL60PS, AT105, AT106, AT95		

			
1			
Part No.	516017	Ref. No.	7918
description	thrust ball bearing shaft ø 11mm ED ø 19mm W 2.4mm plastic		
For models:	AL40, AL40D, AL40E, AL40ET, AL40PS, AL41, AL41E, AL45, AL45D, AL45E, AL45ET, AL45PS, AL46, AL46E, AL54, AL54D		

			
1			
Part No.	516014	Ref. No.	7911
description	bush		
For models:	AL40, AL40D, AL40E, AL40ET, AL40PS, AL41, AL41E, AL45, AL45D, AL45E, AL45ET, AL45PS, AL46, AL46E, AL54, AL54D		

			
1			
Part No.	516129	Ref. No.	4334
description	bush for wash arm		
For models:	AF61, AF610, AF610D, AF610PS, AF610PSW, AF610W, AF61D, AF61DPS, AF61E, AF61ED, AF61EPS, AF61EW, AF61EWP, AF61PS, AF61PSW, AF61W, AF78, AF780, AF780D, AF780PS, AF780PSW, AF780W, AF78D, AF78DPS, AF78E, AF78ED, AF78EDP, AF78EPS, AF78EWP, AF78PS, AF78PSW, AF78W, AF88, AF880, AF88E, AF88EP, AL55, AL55D, AL55PS, ALP33, ALP33E, ALP42, ALP42P, ALP44, ALP44P, AT900		

			
1			
Part No.	516165	Ref. No.	4608
description	bush for wash arm H 25mm thread M4 D1 ø 38mm D2 ø 22mm D3 ø 15mm 4 hole fixing		
For models:	AF78, AF78PS, AF83, AF88, AL60, AL60PS, AT105, AT106, AT95		

			
1			
Part No.	516048	Ref. No.	9632
description	bush for wash arm H 27mm D1 ø 45mm D2 ø 21mm D3 ø 16mm 4 hole fixing		
For models:	AF88, AL55, ALP42, ALP42P, ALP44, ALP44P, AME540, AT105, AT105E, AT110, AT110E, AT112, AT114, AT116, AT95		

			
1			
Part No.	516002	Ref. No.	7101
description	bush for wash arm ø 14mm thread 1/2" WS 24"		
For models:	AL03, AL05, AL05D, AL07, AL07D, AL09, AL09D, AL20, AL20D, AL21, AL25, AL25D, AL26, AL40, AL40D, AL40E, AL40ET, AL40PS, AL41, AL41E, AL45, AL45D, AL45E, AL45ET, AL45PS, AL46, AL46E, AL54, AL54D		

			
1			
Part No.	516018	Ref. No.	7923
description	centring piece		
For models:	AF55, AL40, AL40D, AL40E, AL40ET, AL40PS, AL41, AL41E, AL45, AL45D, AL45E, AL45ET, AL45PS, AL46, AL46E, AL54, AL54D		





			
1			
Part No.	516154	Ref. No.	7415
description	connecting piece		
For models:	AL54, AL54D		

			
1			
Part No.	516046	Ref. No.	9594
description	disc		
For models:	ALP42, ALP42P, ALP44, ALP44P, AT105, AT105E, AT110, AT110E, AT112, AT114, AT116, AT95		

			
1			
Part No.	516005	Ref. No.	7104
description	disc ED ø 14mm thickness 1mm		
For models:	AL03, AL05, AL05D, AL07, AL07D, AL09, AL09D, AL20, AL20D, AL21, AL25, AL25D, AL26, AL40, AL40D, AL40E, AL40ET, AL40PS, AL41, AL41E, AL45, AL45D, AL45E, AL45ET, AL45PS, AL46, AL46E, AL54, AL54D		

			
1			
Part No.	516044	Ref. No.	4623
description	disc ED ø 45.1mm thickness 2.2mm		
For models:	AF78, AF78PS, AF83, AF88, AL60, AL60PS, AT105, AT106, AT95		

			
1			
Part No.	516037	Ref. No.	14207 4603
description	flat gasket ø 20mm ID ø 15mm thickness 3mm		
For models:	AF78, AF78PS, AF83, AF88, AL60, AL60PS, ALP01, ALP01E, ALP01EG, ALP01G, ALP02, ALP02E, ALP02EG, ALP02G, AT105, AT106, AT95		

			
1			
Part No.	516003	Ref. No.	7102
description	gasket graphite ED ø 18.5mm ID ø 14.5mm thickness 2mm Qty 1 pcs		
For models:	AL03, AL05, AL05D, AL07, AL07D, AL09, AL09D, AL10, AL20, AL20D, AL21, AL25, AL25D, AL26, AL30, AL31, AL35, AL36, AL40, AL40D, AL40E, AL40ET, AL40PS, AL41, AL41E, AL45, AL45D, AL45E, AL45ET, AL45PS, AL46, AL46E, AL54, AL54D		

			
1			
Part No.	516166	Ref. No.	4637
description	nut		
For models:	AF78, AF78PS, AF83, AF88, AL60, AL60PS, AT105, AT106, AT95		

			
1			
Part No.	516016	Ref. No.	7934
description	retaining ring bore ø 18mm thickness 1mm SS DIN 472		
For models:	AL40, AL40D, AL40E, AL40ET, AL40PS, AL41, AL41E, AL45, AL45D, AL45E, AL45ET, AL45PS, AL46, AL46E, AL54, AL54D		

			
1			
Part No.	516015	Ref. No.	7933
description	shaft seal ID ø 10.5mm ED ø 17mm thickness 4mm		
For models:	AL40, AL40D, AL40E, AL40ET, AL40PS, AL41, AL41E, AL45, AL45D, AL45E, AL45ET, AL45PS, AL46, AL46E, AL54, AL54D		

			
1			
Part No.	516164	Ref. No.	4446
description	throttle disc		
For models:	AF61, AF610, AF610D, AF610PS, AF610PSW, AF610W, AF61D, AF61DPS, AF61E, AF61ED, AF61EPS, AF61EW, AF61EWP, AF61PS, AF61PSW, AF61W, AF78, AF780, AF780D, AF780PS, AF780PSW, AF780W, AF78D, AF78DPS, AF78E, AF78ED, AF78EDP, AF78EPS, AF78EW, AF78EWP, AF78PS, AF78PSW, AF78W, AF88, AF880, AF88E, AF88EP, AL55, AL55D, AL55PS, ALP33E, AME540, AT900		

rinse arm shafts

			
1			
Part No.	516004	Ref. No.	7103
description	rinse arm shaft		
For models:	AL07, AL07D, AL09, AL09D, AL20, AL20D, AL21, AL25, AL25D, AL26, AL40, AL40D, AL40E, AL40ET, AL40PS, AL41, AL41E, AL45, AL45D, AL45E, AL45ET, AL45PS, AL46, AL46E, AL54, AL54D		





 <p>1</p>			
Part No.	516013	Ref. No.	7912
description	rinse arm shaft		
For models:	AL40, AL40D, AL40E, AL40ET, AL40PS, AL41, AL41E, AL45, AL45D, AL45E, AL45ET, AL45PS, AL46, AL46E, AL54, AL54D		

 <p>1</p>			
Part No.	516035	Ref. No.	4621
description	rinse arm shaft		
For models:	AF78, AF78PS, AF83, AF88, AL60, AL60PS, AT105, AT106, AT95		

 <p>1</p>			
Part No.	516047	Ref. No.	9631
description	rinse arm shaft		
For models:	ALP42, ALP42P, ALP44, ALP44P, AT105, AT105E, AT110, AT110E, AT112, AT114, AT116, AT95		



 <p>1</p>			
Part No.	516138	Ref. No.	4373
description	rinse arm shaft		
For models:	AF61, AF610, AF610D, AF610PS, AF610PSW, AF610W, AF61D, AF61DPS, AF61E, AF61ED, AF61EPS, AF61EW, AF61EWP, AF61PS, AF61PSW, AF61W, AF78, AF780, AF780D, AF780PS, AF780PSW, AF780W, AF78D, AF78DPS, AF78E, AF78ED, AF78EDP, AF78EPS, AF78EW, AF78EWP, AF78PS, AF78PSW, AF78W, AF88, AF880, AF88E, AF88EP, AL55, AL55D, AL55PS, ALP33, ALP33E, AME540		

 <p>1</p>			
Part No.	516139	Ref. No.	4374
description	rinse arm shaft		
For models:	AF61, AF610, AF610D, AF610PS, AF610PSW, AF610W, AF61D, AF61DPS, AF61E, AF61ED, AF61EPS, AF61EW, AF61EWP, AF61PS, AF61PSW, AF61W, AF78, AF780, AF780D, AF780PS, AF780PSW, AF780W, AF78D, AF78DPS, AF78E, AF78ED, AF78EDP, AF78EPS, AF78EW, AF78EWP, AF78PS, AF78PSW, AF78W, AF88, AF880, AF88E, AF88EP, AL55, AL55D, AL55PS, ALP33, ALP33E, ALP42, ALP42P, ALP44, ALP44P, AME540, AT900		

 <p>1</p>			
Part No.	516148	Ref. No.	7350
description	rinse arm shaft ø 14mm thread M10x1		
For models:	AL03, AL05, AL05D		

knobs

producer-specific knobs

ATA			
 <p>1</p>			
Part No.	110740	Ref. No.	7915
description	knob switch zero mark ø 30mm shaft ø 5x5mm shaft flat universal white		
For models:	AF61, AF61D, AF61DPS, AF61PS, AF61PSW, AF61W, AF78, AF78D, AF78DPS, AF78PS, AF88, AL30, AL31, AL35, AL36, AL40, AL40PS, AL41, AL45, AL45PS, AL46, AME540, AT105, AT110, AT900, AT95		
accessories for	110740		
	 <p>Part No.</p>	110741	<p>Ref. No.</p> <p>7913</p>
	sleeve for knob		

 <p>1</p>			
Part No.	110718	Ref. No.	6826
description	knob switch zero mark ø 31mm shaft ø 5x5mm shaft flat universal grey		
For models:	AL40, AL40D, AL40PS, AL45, AL45D, AL45PS		

 <p>1</p>			
Part No.	110091	Ref. No.	4226
description	knob switch zero mark ø 38mm shaft ø 5x5mm shaft flat universal white		
For models:	AF73, AF73PS, AF78, AF78PS, AF83, AF88, AL10, AL11, AL15, AL16, AL20, AL21, AL25, AL26, AL50PS, AL60PS, AT105, AT106, AT95, AZ80, AZ90, AZ91		

1

Part No.	110092	Ref. No.	4228
description	knob switch zero mark ø 38mm shaft ø 6x4.6mm shaft flat lower white		
For models:	AF61, AF61D, AF61DPS, AF61PS, AF61PSW, AF61W, AF78, AF78D, AF78DPS, AF78PS, AF78PSW, AF78W, AF88, AL10, AL15, AL20, AL25, AL30, AL35, AL40, AL40PS, AL45, AL45PS, AL50, AL60, ALP33, AT105, AT106, AT110, AT900, AT95, ATR161, ATR221, ATR311		



1

Part No.	110090	Ref. No.	4227
description	knob switch zero mark t.max.°C ø 38mm shaft ø 6x4.6mm shaft flat upper white		
For models:	AF61, AF73, AF73PS, AF78, AF78PS, AF83, AF88, AL31, AL36, AL41, AL46, AL50PS, AL60PS, ALC100, ALP01, ALP01G, ALP02, ALP02G, ALP42, ALP42P, AME540, AT105, AT110, AT95, ATR161, ATR221, ATR311		

locks

snap locks

universal



1

Part No.	516170	Ref. No.	4713
description	snap lock L 50mm W 10mm H 13mm mounting distance 41mm complete with door catch nickel-plated brass		
For models:	AL03, AL05, AL05D		

baskets

warewashing baskets

steel wire baskets round

mix baskets



1

Part No.	970323	Ref. No.	2031
description	mix basket ED ø 370mm H 145mm seat ø 325mm		



1

Part No.	970324	Ref. No.	7182
description	mix basket ED ø 390mm H 170mm seat ø 325mm		

plastic baskets round



1

Part No.	970699	Ref. No.	5782A
description	mix basket ED ø 380mm H 170mm seat ø 325mm plastic		



1

Part No.	975019	Ref. No.	5781
description	mix basket ED ø 400mm H 180mm		

steel wire baskets square

mix baskets



1

Part No.	971010 ¹	Ref. No.	7281
description	mix basket L 375mm W 375mm H 140mm		

¹wide-meshed



plastic baskets square

mix baskets



1			
Part No.	971097	Ref. No.	7289
description	mix basket L 380mm W 380mm H 150mm		



1			
Part No.	971078	Ref. No.	7282
description	mix basket L 400mm W 400mm H 150mm		

accessories

cutlery inserts



1			
Part No.	976011	Ref. No.	1091
description	cutlery insert Lmm Wmm ø 110mm H 130mm		

basket holders



1			
Part No.	971134	Ref. No.	7227
description	basket support L 375mm W 375mm		



1			
Part No.	971135	Ref. No.	7228
description	basket support L 400mm W 400mm		

gaskets

O-rings

EPDM



1			
Part No.	509014	Ref. No.	7254
description	O-ring EPDM thickness 1.78mm ID ø 107.67mm Qty 1 pcs		
For models:	AL20, AL30, AL31, AL35, AL36, AL40, AL40E, AL40ET, AL40PS, AL41, AL41E, AL45, AL45E, AL45ET, AL45PS, AL46, AL46E, ALC100, ATR161, ATR221, ATR311		

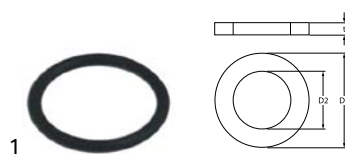

1			
Part No.	504512	Ref. No.	7601
description	O-ring EPDM thickness 1.78mm ID ø 14mm Qty 1 pcs		
For models:	AL03, AL05, AL05D, AL07, AL07D, AL09, AL09D, AL10, AL11, AL15, AL16, AL20, AL20D, AL21, AL25, AL25D, AL26, AL30, AL31, AL35, AL36, AL40, AL40D, AL40E, AL40ET, AL40PS, AL41, AL41E, AL45, AL45D, AL45E, AL45ET, AL45PS, AL46, AL46E, AL54, AL54D, ALC100, ALP01, ALP01E, ALP42, ALP42P, ALP44, ALP44P, ATR100, ATR130, ATR130ED, ATR160, ATR161, ATR190AED...(Other models you can see in the webshop)		



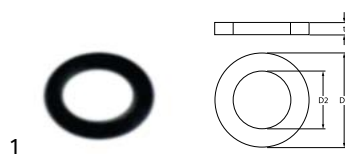

1			
Part No.	529491	Ref. No.	4643
description	O-ring EPDM thickness 1.78mm ID ø 23.52mm Qty 1 pcs		
For models:	AF73, AF73PS, AF78PS, AL50, AL50PS		





1			
Part No.	528485	Ref. No.	4692
description	O-ring EPDM thickness 1.78mm ID ø 6.07mm Qty 1 pcs		
For models:	AF55, AF61, AF610, AF610D, AF610PS, AF610PSW, AF610W, AF61D, AF61DPS, AF61E, AF61ED, AF61EPS, AF61EW, AF61EWP, AF61PS, AF61PSW, AF61W, AF73, AF73PS, AF78, AF780, AF780D, AF780PS, AF780PSW, AF780W, AF78D, AF78DPS, AF78E, AF78ED, AF78EDP, AF78EPS, AF78EW, AF78EWP, AF78PS, AF78PSW, AF78W, AF83, AF88, AF880, AF88E, AF88EP, AL03, AL05, AL05D, AL07, AL07D, AL09, AL09D, AL10, AL11...(Other models you can see in the webshop)		

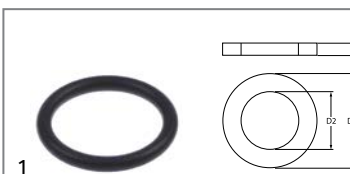

			
Part No.	510177	Ref. No.	4648
description	O-ring EPDM thickness 1.78mm ID \varnothing 7.66mm Qty 1 pcs		
For models:	AF61, AF610, AF610D, AF610PS, AF610PSW, AF610W, AF61D, AF61DPS, AF61E, AF61ED, AF61EPS, AF61EW, AF61EWP, AF61PS, AF61PSW, AF61W, AF73, AF73PS, AF78, AF780, AF780D, AF780PS, AF780PSW, AF780W, AF78D, AF78DPS, AF78E, AF78ED, AF78EDP, AF78EPS, AF78EW, AF78EWP, AF78PS, AF78PSW, AF78W, AF83, AF88, AF880, AF88E, AF88EP, AL03, AL05, AL05D, AL07, AL07D, AL09, AL09D, AL10, AL11, AL15...(Other models you can see in the webshop)		

			
Part No.	528223	Ref. No.	7130
description	O-ring EPDM thickness 2.62mm ID \varnothing 11.91mm Qty 1 pcs		
For models:	AF73, AF73PS, AF78, AF78PS, AF83, AF88, AL03, AL05, AL05D, AL07, AL07D, AL09, AL09D, AL10, AL11, AL15, AL16, AL20, AL20D, AL21, AL25, AL25D, AL26, AL30, AL31, AL35, AL36, AL40, AL40D, AL40E, AL40ET, AL40PS, AL41, AL41E, AL45, AL45D, AL45E, AL45ET, AL45PS, AL46, AL46E, AL50, AL50PS, AL54, AL54D, AL60, AL60PS, ALC100, ALP01, ALP01E...(Other models you can see in the webshop)		

			
Part No.	516026	Ref. No.	7134
description	O-ring EPDM thickness 2.62mm ID \varnothing 17.86mm Qty 1 pcs		
For models:	AL03, AL05, AL05D, AL07, AL07D, AL09, AL09D, AL10, AL11, AL15, AL16, AL20, AL20D, AL21, AL25, AL25D, AL26, AL30, AL31, AL35, AL36, AL40, AL40D, AL40E, AL40ET, AL40PS, AL41, AL41E, AL45, AL45D, AL45E, AL45ET, AL45PS, AL46, AL46E, AL54, AL54D, ALC100, ALP01, ALP01E, ATR161, ATR221, ATR311, KYRA1, KYRA1WAG, KYRA2		

			
Part No.	510769	Ref. No.	4615
description	O-ring EPDM thickness 2.62mm ID \varnothing 25.07mm Qty 1 pcs		
For models:	AF78, AF78PS, AF83, AF88, AL03, AL05, AL05D, AL31, AL36, AL41, AL41E, AL46, AL46E, AL60, AL60PS, AT105, AT106, AT95		

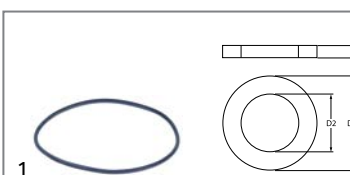
			
Part No.	532490	Ref. No.	7676
description	O-ring EPDM thickness 2.62mm ID \varnothing 72.69mm Qty 1 pcs		
For models:	AF610PSW, AF610W, AF61EW, AF61EWP, AF61PSW, AF61W, AF-780PSW, AF780W, AF78EW, AF78EWP, AF78PSW, AF78W, AL03, AL05, AL05D, AL10, AL11, AL15, AL16, KYRA1, KYRA1WAG, KYRA2		

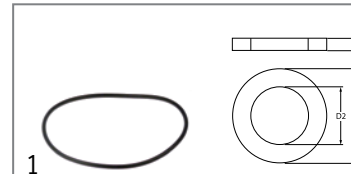
			
Part No.	509018	Ref. No.	7683
description	O-ring EPDM thickness 3.53mm ID \varnothing 107.5mm Qty 1 pcs		
For models:	AL07, AL07D, AL09, AL09D, AL20, AL20D, AL21, AL25, AL25D, AL26, AL40, AL40D, AL40E, AL40PS, AL45, AL45D, AL45E, AL45PS, ALC100, ATR100, ATR130, ATR160, ATR161, ATR190AED, ATR221, ATR311		

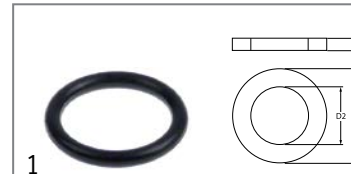
			
Part No.	511322	Ref. No.	1037
description	O-ring EPDM thickness 3.53mm ID \varnothing 20.22mm Qty 1 pcs		
For models:	AF61D, AF61DPS, AF73, AF73PS, AF78, AF78D, AF78DPS, AF78ED, AF78EDP, AF78PS, AF83, AF88, AL05D, AL07, AL07D, AL09, AL09D, AL10, AL11, AL15, AL16, AL20, AL21, AL25, AL26, AL30, AL31, AL35, AL36, AL40, AL40D, AL40E, AL40ET, AL40PS, AL41, AL41E, AL45, AL45D, AL45E, AL45ET, AL45PS, AL46, AL46E, AL50, AL50PS, AL54D, AL55D, AL60, AL60PS, ALC100...(Other models you can see in the webshop)		

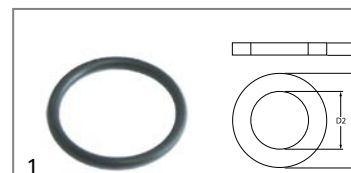
			
Part No.	532657	Ref. No.	13761
description	O-ring EPDM thickness 3.53mm ID \varnothing 31.34mm Qty 1 pcs		
For models:	ATR100, ATR130, ATR130ED, ATR160, ATR190AED, ATR75		

			
Part No.	506015	Ref. No.	4616
description	O-ring EPDM thickness 3.53mm ID \varnothing 39.69mm Qty 1 pcs		
For models:	AF73, AF73PS, AF78, AF78PS, AF83, AF88, AL50, AL50PS, AL60, AL60PS, ALP42, ALP42P, ALP44, ALP44P, AT105, AT105E, AT106, AT110, AT110E, AT112, AT114, AT116, AT95, KYRA1		

			
Part No.	518175	Ref. No.	1033
description	O-ring EPDM thickness 3.53mm ID \varnothing 49.21mm Qty 1 pcs		
For models:	AL20, AL30, AL31, AL35, AL36, AL40, AL41, AL45, AL46		



Part No.	521709	Ref. No.	4704
description	O-ring EPDM thickness 3mm ID \varnothing 126mm Qty 1 pcs		
For models:	AF61, AF610, AF610D, AF610PS, AF610PSW, AF610W, AF61D, AF61DPS, AF61E, AF61ED, AF61EPS, AF61EW, AF61EWP, AF61PS, AF61PSW, AF61W, AF73, AF73PS, AF78, AF780, AF780D, AF780PS, AF780PSW, AF780W, AF78D, AF78DPS, AF78E, AF78ED, AF78EDP, AF78EPS, AF78EW, AF78EWP, AF78PS, AF78PSW, AF78W, AF88, AF880, AF88E, AF88EP, AL50, AL50PS, AL54, AL54D, AL55, AL55D, AL55PS, AL60, AL60PS, ALP33, ALP33E		

Part No.	510408	Ref. No.	4207
description	O-ring EPDM thickness 5.34mm ID \varnothing 47mm Qty 1 pcs		

Part No.	510551	Ref. No.	6633
description	pump cover gasket ID \varnothing 158.3mm pump type 1214/1293/1225/2243/1226/1204/3473/1241 thickness 3.53mm EPDM Qty 1 pcs		
For models:	ALC100, ALP01, ALP01E, ALP01EG, ALP01G, ALP02, ALP02E, ALP02EG, ALP02G, ALP33, ALP42, ALP42P, ALP44, ALP44P, AT105, AT105D, AT105E, AT110, AT110E, AT112, AT114, AT116, AT95, ATR100, ATR130, ATR130ED, ATR160, ATR161, ATR190AED, ATR221, ATR311, ATR75		

Viton

Part No.	550496	Ref. No.	K20007
description	O-ring Viton thickness 3.53mm ID \varnothing 50.39mm Qty 1 pcs		

sealing washers

graphite gaskets

Part No.	516003	Ref. No.	7102
description	gasket graphite ED \varnothing 18.5mm ID \varnothing 14.5mm thickness 2mm Qty 1 pcs		
For models:	AL03, AL05, AL05D, AL07, AL07D, AL09, AL09D, AL10, AL20, AL20D, AL21, AL25, AL25D, AL26, AL30, AL31, AL35, AL36, AL40, AL40D, AL40E, AL40ET, AL40PS, AL41, AL41E, AL45, AL45D, AL45E, AL45ET, AL45PS, AL46, AL46E, AL54, AL54D		

rubber gaskets

Part No.	507080	Ref. No.	4324
description	flat gasket rubber ED \varnothing 39mm ID \varnothing 25mm thickness 1.5mm Qty 1 pcs		
For models:	AF55, AF61, AF610, AF610D, AF610PS, AF610PSW, AF61D, AF61DPS, AF61E, AF61ED, AF61EPS, AF61EW, AF61EWP, AF61PS, AF61PSW, AF78, AF780, AF780D, AF780PS, AF780PSW, AF780W, AF78D, AF78DPS, AF78E, AF78ED, AF78EDP, AF78EPS, AF78EW, AF78EWP, AF78PS, AF78PSW, AF88, AF880, AF88E, AF88EP, AL03, AL05, AL05D, AL07, AL07D, AL09, AL09D, AL10, AL11, AL15, AL16, AL20, AL20D, AL25, AL25D...(Other models you can see in the webshop)		

Part No.	516074	Ref. No.	4125
description	flat gasket rubber ED \varnothing 45mm ID \varnothing 34mm thickness 4mm Qty 1 pcs		
For models:	AF55, AF61, AF610, AF610D, AF610PS, AF610PSW, AF610W, AF61D, AF61DPS, AF61E, AF61ED, AF61EPS, AF61EW, AF61EWP, AF61PS, AF61PSW, AF61W, AF73, AF73PS, AF78, AF780, AF780D, AF780PS, AF780PSW, AF780W, AF78D, AF78DPS, AF78E, AF78ED, AF78EDP, AF78EPS, AF78EW, AF78EWP, AF78PS, AF78PSW, AF78W, AF83, AF88, AF880, AF88E, AF88EP, AL50, AL50PS, AL54, AL54D, AL55, AL55D, AL55PS, AL60, AL60PS...(Other models you can see in the webshop)		

Part No.	516263	Ref. No.	7152
description	flat gasket rubber ED \varnothing 57mm ID \varnothing 34mm thickness 1.5mm Qty 1 pcs		
For models:	AL10, AL11, AL15, AL16, AL20, AL21, AL25, AL26, AL30, AL31, AL35, AL36, AL40, AL40D, AL40E, AL40ET, AL40PS, AL41, AL41E, AL45, AL45D, AL45E, AL45ET, AL45PS, AL46, AL46E, AZ91		

Part No.	516123	Ref. No.	4123
description	flat gasket rubber ED \varnothing 65mm ID \varnothing 50mm thickness 3mm Qty 1 pcs		
For models:	AF55, AF61, AF610, AF610D, AF610PS, AF610PSW, AF610W, AF61D, AF61DPS, AF61E, AF61ED, AF61EPS, AF61EW, AF61EWP, AF61PS, AF61PSW, AF61W, AF73, AF73PS, AF78, AF780, AF780D, AF780PS, AF780PSW, AF780W, AF78D, AF78DPS, AF78E, AF78ED, AF78EDP, AF78EPS, AF78EW, AF78EWP, AF78PS, AF78PSW, AF78W, AF83, AF88, AF880, AF88E, AF88EP, AL50, AL50PS, AL54, AL54D, AL55, AL55D, AL55PS, AL60, AL60PS...(Other models you can see in the webshop)		



PTFE gaskets



1

Part No.	516258	Ref. No.	13629
description	flat gasket PTFE ED \varnothing 32.5mm ID \varnothing 25.5mm thickness 4mm Qty 1 pcs		
For models:	ALC100, ATR100, ATR130, ATR130ED, ATR160, ATR161, ATR190AED, ATR221, ATR311, ATR75		

shaft gaskets

shaft gaskets



1

Part No.	516015	Ref. No.	7933
description	shaft seal ID \varnothing 10.5mm ED \varnothing 17mm thickness 4mm		
For models:	AL40, AL40D, AL40E, AL40ET, AL40PS, AL41, AL41E, AL45, AL45D, AL45E, AL45ET, AL45PS, AL46, AL46E, AL54, AL54D		

special gaskets

door seals for dishwashers

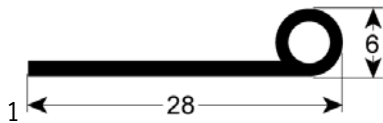

1

Part No.	518234	Ref. No.	7629
description	door seal L 450mm W 28mm H 6mm Qty 1 with 5 holes		
For models:	AL07, AL07D, AL09, AL09D, AL10, AL11, AL15, AL16, AL20, AL21, AL25, AL26		

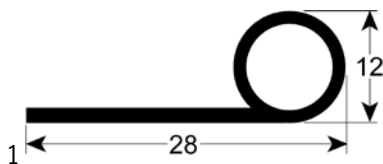

1

Part No.	518104	Ref. No.	6867
description	door seal L 455mm		
For models:	AL20, AL20D, AL25, AL25D		

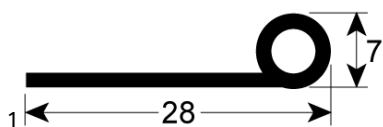

1

Part No.	516251	Ref. No.	4669
description	door seal L 595mm		
For models:	AF61, AF610, AF610D, AF610PS, AF610PSW, AF610W, AF61D, AF61DPS, AF61E, AF61ED, AF61EPS, AF61EW, AF61EWP, AF61PS, AF61PSW, AF61W, AF73, AF73PS, AF78, AF780, AF780D, AF780PS, AF780PSW, AF780W, AF78D, AF78DPS, AF78E, AF78ED, AF78EDP, AF78EPS, AF78EW, AF78EWP, AF78PS, AF78PSW, AF78W, AF83, AF88, AF880, AF88E, AF88EP, AL50, AL50PS, AL60, AL60PS, ALP33E, AME540		



1

Part No.	516260	Ref. No.	4678
description	door seal L 597mm W 17mm H 9.5mm Qty 1 for dishwasher suitable for ATA for AL55 / AF55		
For models:	AF55, AL55, AL55D, AL55PS		

gaskets for wash arm support



1

Part No.	516118	Ref. No.	4104
description	gasket D1 \varnothing 120mm D2 \varnothing 56mm thickness 3mm with 4 screw holes equiv. no. 4104 suitable for ATA		
For models:	AF73, AF73PS, AF83, AL50, AL50PS		



1

Part No.	516141	Ref. No.	4391
description	gasket D1 \varnothing 40mm D2 \varnothing 71mm thickness 2mm with 4 screw holes wash arm support equiv. no. 4391 suitable for ATA		
For models:	AF55, AF61, AF610, AF610D, AF610PS, AF610PSW, AF610W, AF61D, AF61DPS, AF61E, AF61ED, AF61EPS, AF61EW, AF61EWP, AF61PS, AF61PSW, AF61W, AF78, AF780, AF780D, AF780PS, AF780PSW, AF780W, AF78D, AF78DPS, AF78E, AF78ED, AF78EDP, AF78EPS, AF78EW, AF78EWP, AF78PS, AF78PSW, AF78W, AF88, AF880, AF88E, AF88EP, AL20, AL20D, AL25, AL25D, AL40, AL402, AL40D, AL40E, AL40PS, AL41E, AL45, AL45D...(Other models you can see in the webshop)		



1

Part No.	516031	Ref. No.	4619
description	gasket D1 \varnothing 40mm D2 \varnothing 72mm thickness 2mm with 4 screw holes wash arm support		
For models:	AF73, AF73PS, AF78, AF78PS, AF83, AF88, AL50, AL50PS, AL60, AL60PS, ALP01, ALP02, AT105, AT106, AT95		



1			
Part No.	516184	Ref. No.	6810
description	gasket D1 ø 50mm D2 ø 90mm thickness 2mm rubber with 4 screw holes wash arm support equiv. no. 6810 suitable for ATA		
For models:	AL03, AL05, AL40, AL402, AL40D, AL40E, AL40PS, AL45, AL45D, AL45E, AL45PS		

1			
Part No.	516001	Ref. No.	7138
description	gasket D1 ø 61mm D2 ø 90mm thickness 2mm with 4 screw holes wash arm support equiv. no. 7138 suitable for ATA		
For models:	AF55, AF61, AF610, AF610D, AF610PS, AF610PSW, AF610W, AF61D, AF61DPS, AF61E, AF61ED, AF61EPS, AF61EW, AF61EWP, AF61PS, AF61PSW, AF61W, AF78, AF78D, AF780, AF780D, AF780PS, AF780PSW, AF780W, AF78D, AF78DPS, AF78E, AF78ED, AF78EDP, AF78EPS, AF78EW, AF78EWP, AF78PS, AF78PSW, AF78W, AF88, AF880, AF88E, AF88EP, AL03, AL05, AL05D, AL07, AL07D, AL09, AL09D, AL10, AL11, AL15, AL16, AL20...(Other models you can see in the webshop)		

springs

torsion springs

1			
Part No.	516090	Ref. No.	7162
description	torsion spring mounting pos. right for door		
For models:	AL07, AL07D, AL09, AL09D, AL10, AL11, AL15, AL16, AL20, AL20D, AL21, AL25, AL25D, AL26, AL30, AL31, AL35, AL36, AL40, AL402, AL40D, AL40E, AL40ET, AL40PS, AL41, AL41E, AL45, AL45D, AL45E, AL45ET, AL45PS, AL46, AL46E, KYRA1, KYRA1WAG, KYRA2		

1			
Part No.	516114	Ref. No.	4082
description	torsion spring mounting pos. right for door		
For models:	AF55, AF61, AF610, AF610D, AF610PS, AF610PSW, AF610W, AF61D, AF61DPS, AF61E, AF61ED, AF61EPS, AF61EW, AF61EWP, AF61PS, AF61PSW, AF61W, AF73, AF73PS, AF78, AF780, AF780D, AF780PS, AF780PSW, AF780W, AF78D, AF78DPS, AF78E, AF78ED, AF78EDP, AF78EPS, AF78EW, AF78EWP, AF78PS, AF78PSW, AF78W, AF83, AF88, AF880, AF88E, AF88EP, AL50, AL50PS, AL55, AL55D, AL55PS, AL60, AL60PS, ALP33, ALP33E...(Other models you can see in the webshop)		

1			
Part No.	516088	Ref. No.	7160
description	torsion spring ø 15.8mm L2 179mm wire gauge ø 3mm mounting pos. right L1 183mm L3 25mm		
For models:	AL07, AL07D, AL09, AL09D, AL10, AL11, AL15, AL16, AL20, AL20D, AL21, AL25, AL25D, AL26, AL30, AL31, AL35, AL36, AL40, AL402, AL40D, AL40E, AL40ET, AL40PS, AL41, AL41E, AL45, AL45D, AL45E, AL45ET, AL45PS, AL46, AL46E, KYRA1, KYRA1WAG, KYRA2		

compression springs

1			
Part No.	516145	Ref. No.	7166
description	compression spring		
For models:	AF55, AF61, AF61D, AF61DPS, AF61PS, AF73, AF73PS, AF78, AF78D, AF78DPS, AF78E, AF78ED, AF78EDP, AF78EPS, AF78PS, AF83, AF88, AF880, AF88E, AF88EP, AL03, AL05, AL05D, AL07, AL07D, AL09, AL09D, AL10, AL11, AL15, AL16, AL20, AL20D, AL21, AL25, AL25D, AL26, AL30, AL31, AL35, AL36, AL40, AL402, AL40D, AL40E, AL40PS, AL41, AL41E, AL45, AL45D...(Other models you can see in the webshop)		

1			
Part No.	516247	Ref. No.	7635
description	compression spring ø 18mm L 30mm		
For models:	AL10, AL11, AL15, AL16, AL20, AL21, AL25, AL26		



hose reels and spray guns

spray guns



1

Part No.	542038	Ref. No.	14288
description	spray gun for appliances 3/8" IT L 135mm		
For models:	ALP01, ALP01E, ALP01EG, ALP01G, ALP02, ALP02E, ALP02EG, ALP02G		

dosing pumps

peristaltic dosing pumps

SEKO

built-in version

with frequency control



1

Part No.	361923	Ref. No.	5695
description	dosing pump SEKO frequency control 0.1-3l/h 230VAC detergent hose ø 6mm hose type I hose Santoprene suction level 1.5m type PBR		
For models:	KYRA2		
spare parts for	361923		
	Part No.	Ref. No.	—
	361238		
	pump hose SEKO detergent hose ø 6x10mm hose length 135mm hose ø 6mm hose type I hose Santoprene		

piston pumps

dosing pumps



1

Part No.	361260	Ref. No.	5685
description	dosing pump type BR3 230V detergent inlet 6mm outlet 6mm		
For models:	AF55, AF61, AF610, AF610D, AF610PS, AF610PSW, AF610W, AF61D, AF61DPS, AF61E, AF61ED, AF61EPS, AF61EW, AF61EWP, AF61PS, AF-61PSW, AF61W, AF78, AF780, AF780D, AF780PS, AF780PSW, AF780W, AF78D, AF78DPS, AF78E, AF78ED, AF78EDP, AF78EPS, AF78EW, AF78EWP, AF78PS, AF78PSW, AF78W, AF88, AF880, AF88E, AF88EP, AL07, AL07D, AL09, AL09D, AL10, AL11, AL15, AL16, AL20, AL20D, AL21, AL25...(Other models you can see in the webshop)		
accessories for	361260		
	Part No.	Ref. No.	5669
	361261		
	electronic controller conductivity control for 361260 ASF/THOMAS 230V		

with solenoid coil

1

Part No.	361212	Ref. No.	1076 neu
description	dosing pump type ED90		

membrane dosing pumps

self-priming

LANG



1









Part No.	361221	Ref. No.	7945
description	dosing pump type N6 rinse aid pressure connection ø 4x6mm suction connection ø 6x8mm LANG		
For models:	AF55, AF61, AF610, AF610D, AF610PS, AF610PSW, AF610W, AF61D, AF61DPS, AF61E, AF61ED, AF61EPS, AF61EW, AF61EWP, AF61PS, AF61PSW, AF61W, AF73, AF73PS, AF78, AF780, AF780D, AF780PS, AF780PSW, AF780W, AF78D, AF78DPS, AF78E, AF78ED, AF78EDP, AF78EPS, AF78EW, AF78EWP, AF78PS, AF78PSW, AF78W, AF83, AF88, AF880, AF88E, AF88EP, AL03, AL05, AL05D, AL07, AL07D, AL09, AL09D, AL10, AL11...(Other models you can see in the webshop)		
spare parts for	361221		
	Part No.	Ref. No.	—
	361079		
	spring for type N5/N6 for ball		
	Part No.	Ref. No.	—
	361080		
	O-ring EPDM thickness 2mm ID ø 16mm Qty 1 pcs		
	Part No.	Ref. No.	—
	361085		
	O-ring EPDM thickness 2mm ID ø 8mm Qty 1 pcs		
	Part No.	Ref. No.	—
	361309		
	ball for type N5/N6		
	Part No.	Ref. No.	—
	361310		
	bracket for type N6 ball guide		
	Part No.	Ref. No.	—
	361311		
	O-ring EPDM thickness 2mm ID ø 6mm Qty 1 pcs for type N6		
	Part No.	Ref. No.	—
	361314		
	valve ring for type N6 holder for O-ring		
	Part No.	Ref. No.	—
	361317		
	sealing disc for type N6		
	Part No.	Ref. No.	—
	361886		
	non-return valve inletmm outletmm outlet ø 12.4mm L 12.7mm		

Table continues overleaf



spare parts for 361221			
	Part No.	505228	Ref. No. —
spacer bush ID ø 4.5mm ED ø 10mm L 16mm for dosing pump			

SEKO





Part No.	361364 ¹	Ref. No.	5694
description	dosing pump type DIB5E self-sucking rinse aid pump rate 0-5cm ³ per stroke pressure connection ø 4x6mm suction connection ø 4x6mm SEKO supporting pressure closed		

spare parts for 361364

	Part No.	361301	Ref. No. —
hose connector for type DIB3E/DIB5E			

	Part No.	361302	Ref. No. —
valve bush for type DIB3E/DIB5E			

	Part No.	361304	Ref. No. —
O-ring EPDM ID ø 11.11mm thickness 1.78mm Qty 1 pcs for type DIB3E/DIB5E			

	Part No.	361305	Ref. No. —
valve disc for type DIB3E/DIB5E DIB3P/DIB5P			

	Part No.	361306	Ref. No. —
membrane for type DIB3E/DIB5E ø 49mm hole ø 5mm			

	Part No.	361307	Ref. No. —
membrane dosing pump ø 68mm hole ø 6mm for type DIB3P/DIB5P			

	Part No.	361459	Ref. No. —
hose connector ø 6mm for dosing pump			

	Part No.	361481	Ref. No. —
lip valve for type DIB3P/DIB5P DIB3E/DIB5E			

accessories for 361364

	Part No.	361240	Ref. No. —
hose connector 1-way hose ø 6mm plastic connection M10x1			

	Part No.	361241	Ref. No. —
hose connector 1-way hose ø 9mm plastic connection M10x1			

¹auxiliary pressure connection closed

electronic controllers

			
1			
Part No.	361213	Ref. No.	5665
description	electronic controller		
For models:	AF73PS, AF78, AF78PS, AF83, AF88, AL10, AL20, AL30, AL31, AL35, AL36, AL40, AL41, AL45, AL46, AL50, AL50PS, AL60, AL60PS, AT105, AT106, AT95		

			
1			
Part No.	361261	Ref. No.	5669
description	electronic controller conductivity control for 361260 ASF/THOMAS 230V		
For models:	AF55, AF61, AF61D, AF61DPS, AF61PS, AF61PSW, AF61W, AF78, AF78D, AF78DPS, AF78PS, AF78PSW, AF78W, AF88, AL07, AL07D, AL09, AL09D, AL10, AL11, AL15, AL16, AL20, AL20D, AL21, AL25, AL25D, AL26, AL31, AL36, AL40, AL40D, AL40PS, AL41, AL45, AL45D, AL45PS, AL46, AL54, AL54D, AL55, AL55D, AL55PS, ALC100, ALP01, ALP01G, ALP02, ALP02E, ALP02EG, ALP02G... (Other models you can see in the webshop)		

accessories

			
1			
Part No.	516113	Ref. No.	1516
description	container filter		
For models:	AF55, AF61, AF610, AF610D, AF610PS, AF610PSW, AF610W, AF61D, AF61DPS, AF61PS, AF61PSW, AF61W, AF78, AF780, AF780D, AF780PS, AF780PSW, AF780W, AF78D, AF78DPS, AF78E, AF78ED, AF78EDP, AF78EPS, AF78PS, AF78PSW, AF78W, AF88, AF880, AF88E, AL07, AL07D, AL09, AL09D, AL10, AL11, AL15, AL16, AL20, AL20D, AL21, AL25, AL25D, AL26, AL30, AL31, AL35, AL36, AL40, AL402...(Other models you can see in the webshop)		

			
1			
Part No.	361141	Ref. No.	1515
description	container filter with weight ceramic hose ø 4mm		
For models:	AF55, AF61, AF610, AF610D, AF610PS, AF610PSW, AF610W, AF61D, AF61DPS, AF61E, AF61ED, AF61EPS, AF61EW, AF61EWP, AF61PS, AF-61PSW, AF61W, AF78, AF780, AF780D, AF780PS, AF780PSW, AF780W, AF78D, AF78DPS, AF78E, AF78ED, AF78EDP, AF78EPS, AF78EW, AF78EWP, AF78PS, AF78PSW, AF78W, AF88, AF880, AF88E, AF88EP, AL03, AL05, AL05D, AL07, AL07D, AL09, AL09D, AL10, AL11, AL15, AL16, AL20...(Other models you can see in the webshop)		



intake lances



Part No.	361262	Ref. No.	4219 4249 A4249
description	intake lance L 445mm NO hose ø 6x8mm cable length 1500mm		
For models:	AF55, AF61, AF610, AF610D, AF610PS, AF610PSW, AF610W, AF61D, AF61DPS, AF61E, AF61ED, AF61EPS, AF61EW, AF61EWP, AF61PS, AF-61PSW, AF61W, AF78, AF780, AF780D, AF780PS, AF780PSW, AF780W, AF78D, AF78DPS, AF78E, AF78ED, AF78EDP, AF78EPS, AF78EW, AF78EWP, AF78PS, AF78PSW, AF78W, AF88, AF880, AF88E, AF88EP, AL07, AL07D, AL09, AL09D, AL10, AL11, AL15, AL16, AL20, AL20D, AL21, AL25...(Other models you can see in the webshop)		

accessories



Part No.	516096	Ref. No.	7931
description	filter intake lancette		
For models:	AL30, AL31, AL35, AL36, AL40, AL40ET, AL41, AL45, AL45ET, AL46, AT105		

hoses

PVC hoses



Part No.	520090	Ref. No.	7283
description	PVC hose ID ø 4mm ED ø 6mm L 2m thickness 1mm t.max. 60°C transparent		
For models:	AF55, AF61, AF610, AF610D, AF610PS, AF610PSW, AF610W, AF61D, AF61DPS, AF61E, AF61ED, AF61EPS, AF61EW, AF61EWP, AF61PS, AF-61PSW, AF61W, AF78, AF780, AF780D, AF780PS, AF780PSW, AF780W, AF78D, AF78DPS, AF78E, AF78ED, AF78EDP, AF78EPS, AF78EW, AF78EWP, AF78PS, AF78PSW, AF78W, AF88, AF880, AF88E, AF88EP, AL07, AL07D, AL09, AL09D, AL10, AL11, AL15, AL16, AL20, AL20D, AL21, AL25...(Other models you can see in the webshop)		

accessories for 520090

	Part No.	361058	Ref. No.	—
		container filter with non-return valve SS hose ø 4x6mm ø 20mm L 56mm		
	Part No.	361066	Ref. No.	—
		container filter straight SS hose ø 4x6mm L 37mm non return valve ball valve		
	Part No.	361106	Ref. No.	—
		container filter with weight and non-return valve SS hose ø 4x6mm ø 21mm L 51mm non return valve lip valve		
	Part No.	361141	Ref. No.	1515
		container filter with weight ceramic hose ø 4mm		
	Part No.	361230	Ref. No.	—
		container filter with weight stainless steel hose ø 4x6mm		
	Part No.	361462	Ref. No.	—
		container filter with weight SS hose ø 4x6mm		

accessories for 520090

	Part No.	361728	Ref. No.	—
		container filter with 4m 4x6 hose SS hose ø 4x6mm hose length 4000mm		

T-pieces

without non-return valve



Part No.	516082	Ref. No.	7947
description	T-piece plastic hose ø 12-7-12mm 3-way hose ø 12-7-12mmmm		
For models:	AF55, AF61, AF610, AF610D, AF610PS, AF610PSW, AF610W, AF61D, AF61DPS, AF61E, AF61ED, AF61EPS, AF61EW, AF61EWP, AF61PS, AF61PSW, AF61W, AF73, AF73PS, AF78, AF780, AF780D, AF780PS, AF780PSW, AF780W, AF78D, AF78DPS, AF78E, AF78ED, AF78EDP, AF78EPS, AF78EW, AF78EWP, AF78PS, AF78PSW, AF78W, AF83, AF88, AF880, AF88E, AF88EP, AL03, AL05, AL05D, AL07, AL07D, AL09, AL09D, AL10, AL11...(Other models you can see in the webshop)		

tank inlets

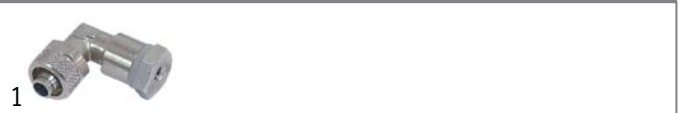

Part No.	516127	Ref. No.	4252
description	tank inlet		
For models:	AF55, AF61, AF61D, AF61DPS, AF61PS, AF61PSW, AF61W, AF78, AF78D, AF78DPS, AF78PS, AF78PSW, AF78W, AF88, AL07, AL07D, AL09, AL09D, AL10, AL11, AL15, AL16, AL20, AL20D, AL21, AL25, AL25D, AL26, AL30, AL31, AL35, AL36, AL40, AL40D, AL40PS, AL41, AL45, AL45D, AL45PS, AL46, AL54, AL54D, AL55, AL55D, AL55PS, ALC100, ALP01, ALP01E, ALP01EG, ALP01G...(Other models you can see in the webshop)		

hoses

drain hoses



Part No.	507329	Ref. No.	7155
description	drain hose DN19 L 1500mm A int. ø 19mm A ext. ø 24mm B int. ø 21mm B ext. ø 28mm outer hose ø 24mm		
For models:	AF610PS, AF610PSW, AF61DPS, AF61E, AF61ED, AF61EPS, AF61EW, AF61EWP, AF61PS, AF61PSW, AF780PS, AF780PSW, AF78DPS, AF78E, AF78ED, AF78EDP, AF78EPS, AF78EW, AF78EWP, AF78PS, AF78PSW, AF88E, AF88EP, AL03, AL05, AL05D, AL07, AL07D, AL09, AL09D, AL10, AL11, AL15, AL16, AL20, AL20D, AL21, AL25, AL25D, AL26, AL30, AL31, AL35, AL36, AL40, AL40D, AL40E, AL40ET, AL40PS...(Other models you can see in the webshop)		





			
1			
Part No.	530574	Ref. No.	4128
description	drain hose DN31 L 2000mm A int. ø 31mm A ext. ø 35mm B int. ø 40mm B ext. ø 46mm outer hose ø 38mm		
For models:	AF55, AF61, AF610, AF610D, AF610W, AF61D, AF61W, AF73, AF78, AF780, AF780D, AF780PS, AF780PSW, AF780W, AF78D, AF78W, AF83, AF88, AF880, AL50, AL54, AL54D, AL55, AL55D, AL60, ALP01, ALP01E, ALP01EG, ALP01G, ALP02, ALP02E, ALP02EG, ALP02G, ALP33, ALP42, ALP42P, ALP44, ALP44P, AME540, AT105, AT105E, AT106, AT110, AT110E, AT112, AT114, AT116, AT95		

industrial hoses

Niplaflex hoses

			
1			
Part No.	530398	Ref. No.	7194 7196
description	pressure hose ID ø 12mm ED ø 19mm L 0.3m thickness 3.5mm operating p. 10bar burst p. 30bar t.max. 110°C black		
For models:	AF55, AF61ED, AF78ED, AF78EDP, AL05, AL07, AL10, AL11, AL16, AL20, AL21, AL25, AL26, AL31, AL36, AL40, AL402, AL40D, AL40E, AL40PS, AL41, AL41E, AL45, AL45D, AL45E, AL45PS, AL46, AL46E, AL54, AL54D, AL55, AL55D, AL55PS, ALP01, ALP01E, ALP01EG, ALP01G, ALP02, ALP02E, ALP02EG, ALP02G, ALP33, ALP33E, AT105, AT105E, AT110, AT110E, AT116, ATR100, ATR130...(Other models you can see in the webshop)		

			
1			
Part No.	530562	Ref. No.	60146
description	pressure hose ID ø 13mm ED ø 21mm L 5m operating p. 10bar burst p. 30bar t.max. 110°C		
For models:	AF88, AF880, AF88E, AF88EP, ALP01EG, ALP01G, ALP33, ALP33E, AT105, AT1050, AT105E, AT110, AT110E, AT112, AT114, AT116, AT95		

			
1			
Part No.	530051 ¹	Ref. No.	51065
description	pressure hose ID ø 15mm ED ø 23mm Lm operating p. 10bar burst p. 30bar t.max. 110°C Qty supplied by meter		

¹by the meter

pressure control hoses

			
1			
Part No.	530429	Ref. No.	7234
description	pressure control hose ID ø 4mm ED ø 8.5mm L 1.15m operating p. 30bar burst p. 90bar temp.-resist. 60°C		
For models:	AL20, AL25, AL30, AL31, AL35, AL36, AL40, AL40D, AL40E, AL40PS, AL41, AL41E, AL45, AL45D, AL45E, AL45PS, AL46, AL46E, ALP42, ALP42P, ALP44, ALP44P, ATR100, ATR130, ATR130ED, ATR160, ATR190AED, ATR75, KYRA1, KYRA1WAG, KYRA2		

			
1			
Part No.	530428	Ref. No.	67140
description	pressure control hose ID ø 4mm ED ø 8.5mm Qty 1.385m		
For models:	AF55, AL40, AL402, AL40D, AL40E, AL40PS, AL41E, AL45, AL45D, AL45E, AL45PS, AL46E, AL54, AL54D, AL55, AL55D, AL55PS, ALP01, ALP01E, ALP01EG, ALP01G, ALP02, ALP02E, ALP02EG, ALP02G		

PVC hoses

PVC hoses without fabric









			
1			
Part No.	520026	Ref. No.	7159 7174
description	PVC hose ID ø 4mm ED ø 6mm L 10m thickness 1mm t.max. 60°C transparent		
For models:	AL30, AL31, AL35, AL36, AL40, AL40D, AL40E, AL40PS, AL41, AL41E, AL45, AL45D, AL45E, AL45PS, AL46, AL46E, ALP01		
accessories for	520026		
	Part No.	361058	Ref. No. —
	container filter with non-return valve SS hose ø 4x6mm L 56mm		
	Part No.	361066	Ref. No. —
	container filter straight SS hose ø 4x6mm L 37mm non return valve ball valve		
	Part No.	361106	Ref. No. —
	container filter with weight and non-return valve SS hose ø 4x6mm ø 21mm L 51mm non return valve lip valve		
	Part No.	361141	Ref. No. 1515
	container filter with weight ceramic hose ø 4mm		
	Part No.	361230	Ref. No. —
	container filter with weight stainless steel hose ø 4x6mm		
	Part No.	361462	Ref. No. —
	container filter with weight SS hose ø 4x6mm		

Table continues overleaf



accessories for	520026		
	Part No.	361728	Ref. No. —
	container filter with 4m 4x6 hose SS hose ø 4x6mm hose length 4000mm		



Part No.	520090	Ref. No.	7283
description	PVC hose ID ø 4mm ED ø 6mm L 2m thickness 1mm t.max. 60°C transparent		
For models:	AF55, AF61, AF610, AF610D, AF610PS, AF610PSW, AF610W, AF61D, AF61DPS, AF61E, AF61ED, AF61EPS, AF61EW, AF61EWP, AF61PS, AF61PSW, AF61W, AF78, AF780, AF780D, AF780PS, AF780PSW, AF780W, AF78D, AF78DPS, AF78E, AF78ED, AF78EDP, AF78EPS, AF78EW, AF78EWP, AF78PS, AF78PSW, AF78W, AF88, AF880, AF88E, AF88EP, AL07, AL07D, AL09, AL09D, AL10, AL11, AL15, AL16, AL20, AL20D, AL21, AL25...(Other models you can see in the webshop)		

accessories for	520090		
	Part No.	361058	Ref. No. —
	container filter with non-return valve SS hose ø 4x6mm ø 20mm L 56mm		
	Part No.	361066	Ref. No. —
	container filter straight SS hose ø 4x6mm L 37mm non return valve ball valve		
	Part No.	361106	Ref. No. —
	container filter with weight and non-return valve SS hose ø 4x6mm ø 21mm L 51mm non return valve lip valve		
	Part No.	361141	Ref. No. 1515
	container filter with weight ceramic hose ø 4mm		
	Part No.	361230	Ref. No. —
	container filter with weight stainless steel hose ø 4x6mm		
	Part No.	361462	Ref. No. —
	container filter with weight SS hose ø 4x6mm		
	Part No.	361728	Ref. No. —
	container filter with 4m 4x6 hose SS hose ø 4x6mm hose length 4000mm		

formed hoses

straight



Part No.	516063	Ref. No.	7942
description	formed hose dishwasher straight		
For models:	AL07, AL07D, AL09, AL09D, AL20, AL21, AL25, AL26, AL31, AL36, AL41, AL41E, AL46, AL46E		



Part No.	516143	Ref. No.	4398
description	formed hose dishwasher straight equiv. no. 4398		
For models:	AF88, AF880, AF88E, AF88EP, ALP33, ALP33E		



Part No.	516064	Ref. No.	4647
description	formed hose dishwasher straight equiv. no. 4647		
For models:	AF83, AF88, ALC100, ATR100, ATR130, ATR160, ATR161, ATR221, ATR311		





Part No.	516059	Ref. No.	9706
description	formed hose dishwasher straight equiv. no. 9706		
For models:	ALP42, ALP42P, ALP44, ALP44P, AT105, AT110, AT112, AT114, AT116, AT95		



Part No.	516061	Ref. No.	7171
description	formed hose ext. ø 49 L 50mm dishwasher straight hose int. ø 39mm equiv. no. 7171		
For models:	AF61, AF610, AF610D, AF610PS, AF610PSW, AF610W, AF61D, AF61DPS, AF61E, AF61ED, AF61EPS, AF61EW, AF61EWP, AF61PS, AF61PSW, AF61W, AF73, AF73PS, AF78, AF780, AF780D, AF780PS, AF780PSW, AF780W, AF78D, AF78DPS, AF78E, AF78ED, AF78EDP, AF78EPS, AF78EW, AF78EWP, AF78PS, AF78PSW, AF78W, AL20, AL21, AL25, AL26, AL30, AL31, AL35, AL36, AL40, AL41, AL45, AL46, AL50, AL50PS, AL60...(Other models you can see in the webshop)		



			
1			
Part No.	516125	Ref. No.	4137
description	formed hose ext. ø 60 L 50mm dishwasher straight hose int. ø 50mm equiv. no. 4137		
For models:	AF73, AF73PS, AF78, AF78PS, AL50, AL50PS, AL60, AL60PS, ALP01, ALP01E, ALP01EG, ALP01G, ALP02, ALP02E, ALP02EG, ALP02G, ATR100, ATR130, ATR130ED, ATR160, ATR161, ATR190AED, ATR221, ATR311		

			
1			
Part No.	516060	Ref. No.	7631
description	formed hose straight ED ø 37mm ID ø 27mm L 56.5mm for dishwasher equiv. no. 7631		
For models:	AL10, AL11, AL15, AL16		

form L

			
1			
Part No.		Ref. No.	7941 7941 n.m.lieferbar
description	formed hose		
For models:	AL30, AL31, AL35, AL36, AL40, AL40ET, AL41, AL45, AL45ET, AL46		

			
1			
Part No.	516142	Ref. No.	4393
description	formed hose warewashing L-shape equiv. no. 4393		
For models:	AF61, AF610, AF610D, AF610PS, AF610PSW, AF610W, AF61D, AF61DPS, AF61E, AF61ED, AF61EPS, AF61EW, AF61EWP, AF61PS, AF61PSW, AF61W, AF78, AF780, AF780D, AF780PS, AF780PSW, AF780W, AF78D, AF78DPS, AF78E, AF78ED, AF78EDP, AF78EPS, AF78EW, AF78EWP, AF78PS, AF78PSW, AF78W, AF88, AF880, AF88E, AF88EP, ALC100, ALP01, ALP01E, ALP01EG, ALP01G, ALP02, ALP02E, ALP02EG, ALP02G, ALP33, ALP33E, ALP44, ALP44P...(Other models you can see in the webshop)		

			
1			
Part No.	516057	Ref. No.	4638
description	formed hose warewashing L-shape equiv. no. 4638 hose int. ø 50mm		
For models:	AF73, AF73PS, AF78, AF78PS, AL50, AL50PS, AL54, AL54D, AL55, AL55D, AL55PS, AL60, AL60PS, ALC100, ALP01, ALP01E, ALP01EG, ALP01G, ALP02, ALP02E, ALP02EG, ALP02G, ALP44, ALP44P, AT105, AT106, AT95, ATR100, ATR130, ATR130ED, ATR160, ATR161, ATR190AED, ATR221, ATR311		

			
1			
Part No.	516058	Ref. No.	4639
description	formed hose warewashing L-shape equiv. no. 4639		
For models:	AF83, AF88, AT105, AT106, AT95		

			
1			
Part No.	516055	Ref. No.	7170
description	formed hose warewashing L-shape equiv. no. 7170 hose ext. ø 55mm hose int. ø 45mm		
For models:	AL07, AL07D, AL09, AL09D, AL20, AL21, AL25, AL26, AL30, AL31, AL35, AL36, AL40, AL402, AL40E, AL40PS, AL41, AL41E, AL45, AL45E, AL45PS, AL46, AL46E, ALP01E, ALP01EG, ALP02E, ALP02EG		

			
1			
Part No.	516054	Ref. No.	7630
description	formed hose warewashing L-shape equiv. no. 7630		
For models:	AL10, AL11, AL15, AL16		

1

Part No.	516062	Ref. No.	7943
description	formed hose warewashing L-shape equiv. no. 7943 hose int. ø 40mm		
For models:	AL20, AL20D, AL25, AL25D, AL30, AL35, AL40, AL402, AL40D, AL40E, AL40ET, AL40PS, AL45, AL45D, AL45E, AL45ET, AL45PS, AL54, AL54D, AL55, AL55D, AL55PS		



1

Part No.	516065	Ref. No.	9651
description	formed hose warewashing L-shape equiv. no. 9651		
For models:	ALP42, ALP42P, ALP44, ALP44P, AT105, AT105D, AT105E, AT110, AT110E, AT112, AT114, AT116, AT116D, AT116E, ATR100, ATR130, ATR160, ATR190AED		

form S



1

Part No.	516188	Ref. No.	6809
description	extraction hose		
For models:	AL40, AL40D, AL40E, AL40PS, AL45, AL45D, AL45E, AL45PS		

form U



1

Part No.	516244	Ref. No.	4396
description	formed hose warewashing U-shape		
For models:	AF55, AF61ED, AF78ED, AF88, AF880, AF88E, AF88EP, AL55, AL55D, AL55PS, ALP33, ALP33E, AT900		

for dishwashers

miscellaneous



1

Part No.	530411	Ref. No.	9719
description	extraction hose ED ø 9mm ID ø 5mm L 2000mm detergent black		
For models:	AF55, AF61, AF610, AF610D, AF610PS, AF610PSW, AF610W, AF61D, AF61DPS, AF61PS, AF61PSW, AF61W, AF78, AF780, AF780D, AF780PS, AF780PSW, AF780W, AF78D, AF78DPS, AF78PS, AF78PSW, AF78W, AF88, AF880, AL07, AL07D, AL09, AL09D, AL10, AL11, AL15, AL16, AL20, AL20D, AL21, AL25, AL25D, AL26, AL30, AL31, AL35, AL36, AL40, AL402, AL40D, AL40PS, AL41, AL45, AL45D...(Other models you can see in the webshop)		

fittings, hose and pipe connectors

hose connectors

without screw connection



1

Part No.	519216	Ref. No.	1056
description	T-piece plastic hose ø 12-12-12mm 3-way		
For models:	AF55, AF61, AF610, AF610D, AF610PS, AF610PSW, AF610W, AF61D, AF61E, AF61ED, AF61EPS, AF61EW, AF61EWP, AF61PS, AF61PSW, AF61W, AF78, AF780, AF780D, AF780PS, AF780PSW, AF780W, AF78D, AF78E, AF78ED, AF78EDP, AF78EPS, AF78EW, AF78EWP, AF78PS, AF78PSW, AF78W, AF88, AF880, AF88E, AF88EP, AL03, AL05D, AL07, AL07D, AL09D, AL15, AL16, AL20, AL20D, AL25, AL25D, AL26, AL30, AL31...(Other models you can see in the webshop)		



			
1			
Part No.	516082	Ref. No.	7947
description	T-piece plastic hose ø 12-7-12mm 3-way hose ø 12-7-12mmmm		
For models:	AF55, AF61, AF610, AF610D, AF610PS, AF610PSW, AF610W, AF61D, AF61DPS, AF61E, AF61ED, AF61EPS, AF61EW, AF61EWP, AF61PS, AF61PSW, AF61W, AF73, AF73PS, AF78, AF780, AF780D, AF780PS, AF780PSW, AF780W, AF78D, AF78DPS, AF78E, AF78ED, AF78EDP, AF78EPS, AF78EW, AF78EWP, AF78PS, AF78PSW, AF78W, AF83, AF88, AF880, AF88E, AF88EP, AL03, AL05, AL05D, AL07, AL07D, AL09, AL09D, AL10, AL11...(Other models you can see in the webshop)		

			
1			
Part No.	516103	Ref. No.	3001
description	manifold plastic hose ø 12-12-12-12mm 4-way		
For models:	AF61, AF61D, AF61DPS, AF61PS, AF78, AF78D, AF78DPS, AF78PS, AL05, AL09, AL25, AL40, AL402, AL40E, AL40PS, AL41, AL41E, AL45, AL45E, AL45PS, AL46, AL46E, ALP44, ALP44P, AME540		

hose connectors

nickel-plated brass

			
1			
Part No.	520202	Ref. No.	4999
description	hose connector nickel-plated brass straight thread 3/8" hose ø 12mm Qty 1 pcs		
For models:	ALP01, ALP01E, ALP01EG, ALP01G, ALP33, ALP33E, ALP42, ALP42P, ALP44, ALP44P, AT105, AT110, AT112, AT114, AT116, AT95, ATR75		

measuring equipment

thermometers

built-in thermometers

			
1			
Part No.	541095	Ref. No.	13725
description	thermometer mounting measurements 58x25.5mm 0 up to +120°C capillary pipe 3000mm probe ø 6.5mm probe L 20mm		
For models:	AF78, AF78D, AF78DPS, AF78PS, AF78PSW, AF78W, AF88, ALC100, ALP33, ALP42, ALP42P, AME540, AT105, AT110, AT900, AT95, ATR161		

fastening material

nuts

wing nuts

			
1			
Part No.	560147	Ref. No.	1013
description	wing nuts thread M6 SS DIN/ISO DIN 315 Qty 20 pcs		
For models:	AF73, AF73PS, AF78, AF78PS, AF83, AF88, AL03, AL05, AL05D, AL07, AL07D, AL09, AL09D, AL10, AL11, AL15, AL16, AL20, AL21, AL25, AL26, AL30, AL31, AL35, AL36, AL40, AL40E, AL40ET, AL40PS, AL41, AL41E, AL45, AL45E, AL45ET, AL45PS, AL46, AL46E, AL50, AL50PS, AL60, AL60PS, AT105, AT106, AT95		

hexagonal nuts

hexagonal nuts metric (without norm)

			
1			
Part No.	516166	Ref. No.	4637
description	nut		
For models:	AF78, AF78PS, AF83, AF88, AL60, AL60PS, AT105, AT106, AT95		

hexagonal nuts inch thread

			
1			
Part No.	516069	Ref. No.	7153
description	nut thread 1" ø 46mm H 8mm WS 36 brass Qty 1 pcs		
For models:	AL10, AL11, AL15, AL16, AL20, AL21, AL25, AL26, AL30, AL31, AL35, AL36, AL40, AL40D, AL40E, AL40ET, AL40PS, AL41, AL41E, AL45, AL45D, AL45E, AL45ET, AL45PS, AL46, AL46E, AZ91		

			
1			
Part No.	516073	Ref. No.	4124
description	nut thread 1½" ø 66mm H 10.5mm WS 52 brass Qty 1 pcs		
For models:	AF55, AF61, AF610, AF610D, AF610PS, AF610PSW, AF610W, AF61D, AF61DPS, AF61E, AF61ED, AF61EPS, AF61EW, AF61EWP, AF61PS, AF61PSW, AF61W, AF73, AF73PS, AF78, AF780, AF780D, AF780PS, AF780PSW, AF780W, AF78D, AF78DPS, AF78E, AF78ED, AF78EDP, AF78EPS, AF78EW, AF78EWP, AF78PS, AF78PSW, AF78W, AF83, AF88, AF880, AF88E, AF88EP, AL50, AL50PS, AL54, AL54D, AL55, AL55D, AL55PS, AL60, AL60PS...(Other models you can see in the webshop)		



fasteners

slot nuts



1

Part No.	560288	Ref. No.	13688
description	slot nut W 8mm H 7mm L 25mm		
For models:	ALC100, ATR100, ATR130, ATR160, ATR161, ATR221, ATR311, ATR75		

retaining rings

DIN 471



1

Part No.	516222	Ref. No.	7119
description	retaining ring shaft \varnothing 12mm thickness 1mm SS DIN 471		
For models:	AL10, AL11, AL15, AL16, AL30, AL31, AL35, AL36, ALP01, ALP01E, ALP01EG, ALP01G, ATR75, KYRA1WAG		

DIN 472



1

Part No.	516016	Ref. No.	7934
description	retaining ring bore \varnothing 18mm thickness 1mm SS DIN 472		
For models:	AL40, AL40D, AL40E, AL40ET, AL40PS, AL41, AL41E, AL45, AL45D, AL45E, AL45ET, AL45PS, AL46, AL46E, AL54, AL54D		

DIN 6799



1

Part No.	516198	Ref. No.	52061
description	retaining ring E D1 \varnothing 6mm D2 \varnothing 12mm SS DIN 6799 thickness 0.7mm for shaft \varnothing 7-9mm		
For models:	AT105, AT95		



1

Part No.	697864	Ref. No.	13159
description	ring E D1 \varnothing 37mm D2 \varnothing 19mm steel DIN 6799 thickness 2mm		
For models:	ALC100, ATR100, ATR130, ATR130ED, ATR160, ATR161, ATR190AED, ATR221, ATR311, ATR75		

roll pins



1

Part No.	516091	Ref. No.	7167
description	roll pin \varnothing 3mm L 22mm stainless steel		
For models:	AF61, AF61D, AF61DPS, AF61PS, AF78, AF78D, AF78DPS, AF78E, AF78ED, AF78EDP, AF78EPS, AF78PS, AF88, AF88E, AL07, AL07D, AL09, AL09D, AL10, AL11, AL15, AL16, AL20, AL20D, AL21, AL25, AL25D, AL26, AL30, AL31, AL35, AL36, AL40, AL402, AL40D, AL40E, AL40ET, AL40PS, AL41, AL41E, AL45, AL45D, AL45E, AL45ET, AL45PS, AL46, AL46E, AL54, AL54D, AL55...(Other models you can see in the webshop)		



1

Part No.	516242	Ref. No.	4185
description	roll pin \varnothing 3mm L 26mm		
For models:	AF55, AF61, AF610, AF610D, AF610PS, AF610PSW, AF610W, AF61D, AF61DPS, AF61E, AF61ED, AF61EPS, AF61EW, AF61EWP, AF61PS, AF61PSW, AF61W, AF73, AF73PS, AF78, AF780, AF780D, AF780PS, AF780PSW, AF780W, AF78D, AF78DPS, AF78E, AF78ED, AF78EDP, AF78EPS, AF78EW, AF78EWP, AF78PS, AF78PSW, AF78W, AF83, AF88, AF880, AF88E, AF88EP, AL50, AL50PS, AL60, AL60PS, ALP33, ALP33E		

GASTROPARTS.COM

