



**GASTROPARTS**

# Argion

- [EN]** Equipment
- [DE]** Geräte
- [ES]** Aparatos
- [FR]** Équipement
- [IT]** Attrezzature
- [PL]** Urządzenia
- [RU]** Оборудование

✉ [gastroparts@gastroparts.com](mailto:gastroparts@gastroparts.com)

☎ +48 56 657 00 66

📘 [fb.com/gastroparts.global](https://fb.com/gastroparts.global)

**GASTROPARTS.COM**





## switches and momentary switches

### microswitches

pin-plunger actuated

miscellaneous



1

<b>Part No.</b>	348187	<b>Ref. No.</b>	HVS1000-47 YJS82YJS820-47
<b>description</b>	microswitch 230V 1NO connection cable 400mm L 58mm L1 38mm		

## electronics

### PCBs



1

<b>Part No.</b>	403716	<b>Ref. No.</b>	HSV1000-37
<b>description</b>	display PCB vacuum packing machine HVS1000 L 78mm W 55mm		



1

<b>Part No.</b>	403715	<b>Ref. No.</b>	HVS1000-42 YJS820-42
<b>description</b>	main PCB vacuum packing machine HVS1000 L 88mm W 75mm		



1

<b>Part No.</b>	403717	<b>Ref. No.</b>	HVS1000-25 YJS820-25
<b>description</b>	PCB vacuum packing machine HVS1000 L 125mm W 100mm		

## keypads

### membrane keypads



1

<b>Part No.</b>	403718	<b>Ref. No.</b>	HVS1000-36 YJS820-36
<b>description</b>	membrane keypad vacuum packing machine HVS1000 L 190mm W 55mm		

## solenoid valves

### solenoid valves (water)

various



1

<b>Part No.</b>	374094	<b>Ref. No.</b>	HVS1000-45 YJS820-45
<b>description</b>	solenoid valve angled 2-way inlet 4.5mm outlet 4.5mm cable length 300mm		



1

<b>Part No.</b>	374093	<b>Ref. No.</b>	HVS1000-41 YJS820-41
<b>description</b>	solenoid valve single 2-way 12VDC inlet 11mm outlet 11mm suitable for exit		



1

<b>Part No.</b>	374092	<b>Ref. No.</b>	HSV1000-26
<b>description</b>	solenoid valve single 2-way 12VDC inlet 11mm outlet 11mm suitable for input		



metal

ASCO

spare parts and accessories

O-rings



1

<b>Part No.</b>	371100	<b>Ref. No.</b>	HVS1000-04 YJS820-4
<b>description</b>	O-ring silicone thickness 1.78mm ID ø 6.07mm Qty 1 pcs		

### Solenoid valve - accessories



1

<b>Part No.</b>	371100	<b>Ref. No.</b>	HVS1000-04 YJS820-4
<b>description</b>	O-ring silicone thickness 1.78mm ID ø 6.07mm Qty 1 pcs		

## pumps

### vacuum pumps

vacuum pumps



1

<b>Part No.</b>	602111	<b>Ref. No.</b>	HVS1000-30 YJS820-30
<b>description</b>	vacuum pump 220/240V 0.32kW 50Hz type OLF400Z		

## electric accessories

### plugs - couplings - power sockets

appliance sockets/plugs

low temperature appliances 70°C

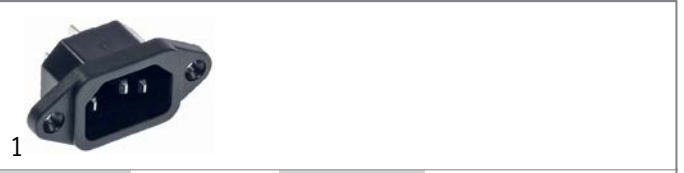

1

<b>Part No.</b>	551334	<b>Ref. No.</b>	HVS1000-38 YJS820-38
<b>description</b>	plug for box mounting receptacles C14 max 10A/250V F4.8		

### cables

power supply cables



1

<b>Part No.</b>	550726	<b>Ref. No.</b>	HVS1000-39 YJS820-39
<b>description</b>	low temperature appliance supply cable CEE7/7 - C15 3-pole contacts P+N+E 1mm <sup>2</sup> max. 10A max 250V 2.0m H05VVF T70 2-pole + earthing insulation PVC		

## equipment-specific units

for vacuum packers

lids



1

<b>Part No.</b>	699600	<b>Ref. No.</b>	HVS1000-02 YJS820-2
<b>description</b>	lid L 420mm W 350mm HVS1000		



air cylinders

air cylinders



1			
<b>Part No.</b>	692702	<b>Ref. No.</b>	HVS1000-17 YJS820-17
<b>description</b>	air cylinder ø 53mm H 30.5mm shaft length 12.8mm 1 pair		

housing and bezels



1			
<b>Part No.</b>	699610	<b>Ref. No.</b>	HVS1000-34 YJS820-34
<b>description</b>	front panel for vacuum packing machine W 100mm H 40mm HVS1000 L 250mm		

rubber bumper



1			
<b>Part No.</b>	699607	<b>Ref. No.</b>	HVS1000-31 YJS820-31
<b>description</b>	rubber pad H 3mm L 30mm W 20mm 4 pieces		

sealing bars



1			
<b>Part No.</b>	699601	<b>Ref. No.</b>	HVS1000-07 YJS820-7
<b>description</b>	sealing bar L 295mm W 20mm H 24mm		

base plate



1			
<b>Part No.</b>	699617	<b>Ref. No.</b>	HVS1000-24 YJS820-24
<b>description</b>	base plate L 132mm W 105mm H 0.5mm		



1			
<b>Part No.</b>	699611	<b>Ref. No.</b>	HVS1000-01 YJS820-1
<b>description</b>	base plate L 30mm W 30mm H 2mm 1 pair hole ø 5mm		

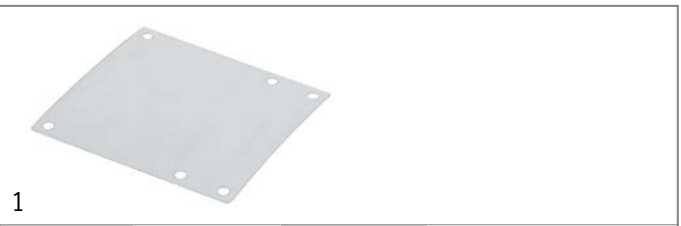

1			
<b>Part No.</b>	699445	<b>Ref. No.</b>	HVS1000-43 YJS820-43
<b>description</b>	base plate L 95mm W 90mm H 0.5mm		

miscellaneous



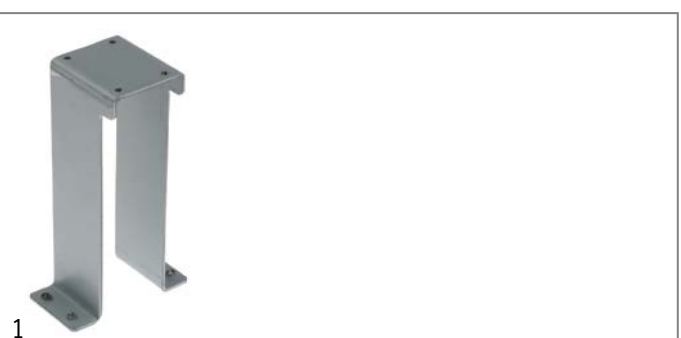

1			
<b>Part No.</b>	699603	<b>Ref. No.</b>	HSV1000-05
<b>description</b>	bracket L 298mm W 23mm H 9.5mm		



1			
<b>Part No.</b>	699604	<b>Ref. No.</b>	HVS1000-48 YJS820-48
<b>description</b>	bracket L 38mm W 36mm H 124mm for microswitch		



			
1			
<b>Part No.</b>	699605	<b>Ref. No.</b>	HVS1000-14 YJS820-14
<b>description</b>	clamp L 95mm W 34mm H 48mm		

			
1			
<b>Part No.</b>	699608	<b>Ref. No.</b>	HVS1000-10 YJS820-10
<b>description</b>	nut for air inlet thread 1/4"		

			
1			
<b>Part No.</b>	699613	<b>Ref. No.</b>	HVS1000-13 YJS820-13
<b>description</b>	plug L 9mm W 6mm 1 pair		

			
1			
<b>Part No.</b>	699602	<b>Ref. No.</b>	HVS1000-06 YJS820-6
<b>description</b>	rubber rail L 298mm W 23mm H 9.5mm for sealing bar		

			
1			
<b>Part No.</b>	699609	<b>Ref. No.</b>	HVS1000-12 YJS820-12
<b>description</b>	spring L 104mm W 32mm to secure		

## handles and hand wheels

## bracket handles

			
1			
<b>Part No.</b>	699606	<b>Ref. No.</b>	HVS1000-03 YJS820-3
<b>description</b>	handle L 140mm H 38mm mounting distance 120mm hole $\varnothing$ 8.5mm		

## equipment feet and end caps

## bolting feet

			
1			
<b>Part No.</b>	701555	<b>Ref. No.</b>	HVS1000-40 YJS820-40
<b>description</b>	equipment feet kit $\varnothing$ 39mm H 17mm Qty 4 pcs		

## gaskets

## O-rings

## silicone

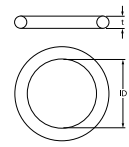
 			
1			
<b>Part No.</b>	371100	<b>Ref. No.</b>	HVS1000-04 YJS820-4
<b>description</b>	O-ring silicone thickness 1.78mm ID $\varnothing$ 6.07mm Qty 1 pcs		

## special gaskets

## for vacuum packers

			
1			
<b>Part No.</b>	699618	<b>Ref. No.</b>	HVS1000-08 YJS820-8
<b>description</b>	lid gasket L 1365mm		



## springs

### gas tension springs

#### gas tension springs



1

<b>Part No.</b>	701553	<b>Ref. No.</b>	HVS1000-21 YJS820-21
<b>description</b>	gas tension spring left 80N D1 ø 6mm D2 ø 15mm L 162mm HVS1000		



1

<b>Part No.</b>	701554	<b>Ref. No.</b>	HVS1000-46 YJS820-46
<b>description</b>	gas tension spring right 80N D1 ø 6mm D2 ø 15mm L 162mm HVS1000		

## manometers



1

<b>Part No.</b>	542340	<b>Ref. No.</b>	HVS1000-35 YJS820-35
<b>description</b>	manometer ø 41mm pressure range 0-1bar connection 5mm		

## fittings, hose and pipe connectors

### hose connectors

#### without screw connection



1

<b>Part No.</b>	699612	<b>Ref. No.</b>	HVS1000-15 YJS820-15
<b>description</b>	T-piece plastic hose ø 5-5-5mm		



1

<b>Part No.</b>	504817	<b>Ref. No.</b>	HVS1000-29 YJS820-29
<b>description</b>	T-piece SS hose ø 10-10-10mm		



1

<b>Part No.</b>	504823	<b>Ref. No.</b>	HVS1000-28 YJS820-28
<b>description</b>	cross fitting SS hose ø 10-10-10-10mm L 57mm W 57mm		

## hose connectors

### producer-specific



1

<b>Part No.</b>	699615	<b>Ref. No.</b>	HVS1000-11 YJS820-11
<b>description</b>	hose connector for hose ID 10mm connection 1/4"mm L-shape		

## fastening material

### screws

#### hexagonal screws



1

<b>Part No.</b>	699616	<b>Ref. No.</b>	HVS1000-23 YJS820-23
<b>description</b>	screw thread M10 thread L 26mm WS 17 Qty 2 pcs head thickness 7mm L 60mm		

### nuts

#### hexagonal nuts

DIN 934 / ISO 4032/8673



1

<b>Part No.</b>	560197	<b>Ref. No.</b>	HVS1000-20 YJS820-20
<b>description</b>	nut thread M10 H 8mm WS 17 SS DIN/ISO DIN 934 / ISO 4032/8673 Qty 1 pcs		



 1			
<b>Part No.</b>	506166	<b>Ref. No.</b>	HVS1000-16 YJS820-16
<b>description</b>	nut thread M12 H 10mm WS 19 SS DIN/ISO DIN 934 / ISO 4032/8673 Qty 1 pcs		

## washers

## washers

## miscellaneous

 1			
<b>Part No.</b>	560593	<b>Ref. No.</b>	HVS1000-22 YJS820-22
<b>description</b>	plain washer ID ø 10.5mm ED ø 15.8mm thickness 1mm SS Qty 4 pcs		

**GASTRO**PARTS.COM

