



**GASTROPARTS**

# Anliker

- [EN]** Equipment
- [DE]** Geräte
- [ES]** Aparatos
- [FR]** Équipement
- [IT]** Attrezzature
- [PL]** Urządzenia
- [RU]** Оборудование

✉ [gastroparts@gastroparts.com](mailto:gastroparts@gastroparts.com)

☎ +48 56 657 00 66

📘 [fb.com/gastroparts.global](https://fb.com/gastroparts.global)

**GASTROPARTS.COM**





## heating elements

### accessories

#### hexagonal nuts



1

|                    |   |                 |           |
|--------------------|---|-----------------|-----------|
| <b>Part No.</b>    | 560131  | <b>Ref. No.</b> | 810.10022 |
| <b>description</b> | hexagonal nut thread M4 H 3.2mm WS 7 SS DIN/ISO DIN 934 / ISO 4032/8673 Qty 20 pcs                                    |                 |           |
| <b>For models:</b> | GSM-anlikerXL-STANDARD, GSM-anlikerXL-STAR, GSM-FIVE-STANDARD, GSM-FIVE-STAR, GSM-Quattro-PROFI, GSM-Quattro-STANDARD |                 |           |



1

|                    |   |                 |           |
|--------------------|---|-----------------|-----------|
| <b>Part No.</b>    | 560132  | <b>Ref. No.</b> | 810.10032 |
| <b>description</b> | hexagonal nut thread M5 H 4mm WS 8 SS DIN/ISO DIN 934 / ISO 4032/8673 Qty 20 pcs                                      |                 |           |
| <b>For models:</b> | GSM-anlikerXL-STANDARD, GSM-anlikerXL-STAR, GSM-FIVE-STANDARD, GSM-FIVE-STAR, GSM-Quattro-PROFI, GSM-Quattro-STANDARD |                 |           |

#### washers



1

|                    |   |                 |           |
|--------------------|---|-----------------|-----------|
| <b>Part No.</b>    | 560111  | <b>Ref. No.</b> | 812.60032 |
| <b>description</b> | plain washer ID $\varnothing$ 4.3mm ED $\varnothing$ 9mm thickness 0.8mm SS Qty 20 pcs DIN 125A for thread M4 |                 |           |
| <b>For models:</b> | GSM-FIVE-STANDARD, GSM-FIVE-STAR, GSM-Quattro-PROFI, GSM-Quattro-STANDARD                                     |                 |           |



1

|                    |   |                 |           |
|--------------------|---|-----------------|-----------|
| <b>Part No.</b>    | 560112  | <b>Ref. No.</b> | 812.10032 |
| <b>description</b> | plain washer ID $\varnothing$ 5.3mm ED $\varnothing$ 10mm thickness 1mm SS Qty 20 pcs DIN 125A for thread M5          |                 |           |
| <b>For models:</b> | GSM-anlikerXL-STANDARD, GSM-anlikerXL-STAR, GSM-FIVE-STANDARD, GSM-FIVE-STAR, GSM-Quattro-PROFI, GSM-Quattro-STANDARD |                 |           |

#### tooth lock washers



1

|                    |   |                 |           |
|--------------------|---|-----------------|-----------|
| <b>Part No.</b>    | 560125  | <b>Ref. No.</b> | 814.20022 |
| <b>description</b> | tooth lock washer ID $\varnothing$ 4.2mm ED $\varnothing$ 8mm SS DIN/ISO DIN 6798A Qty 20 pcs for thread M4 |                 |           |
| <b>For models:</b> | GSM-FIVE-STANDARD, GSM-FIVE-STAR, GSM-Quattro-PROFI, GSM-Quattro-STANDARD                                   |                 |           |

## switches and momentary switches

### magnetic switches

#### M8x1.25



1

|                    |   |                 |           |
|--------------------|---|-----------------|-----------|
| <b>Part No.</b>    | 347558  | <b>Ref. No.</b> | 708.04020 |
| <b>description</b> | magnetic switch 1NO thread M8x1.25 cable length 300mm   |                 |           |
| <b>For models:</b> | GSM-anlikerXL-STANDARD, GSM-anlikerXL-STAR, GSM-FIVE-STANDARD, GSM-FIVE-STAR, GSM-Quattro-PROFI, GSM-Quattro-STANDARD |                 |           |

## motors

### motors

#### for vegetable slicers



1

|                    |  |                 |           |
|--------------------|--|-----------------|-----------|
| <b>Part No.</b>    | 499124   | <b>Ref. No.</b> | 235.91815 |
| <b>description</b> | motor 230V 260W 50Hz 2760rpm 1 phase shaft $\varnothing$ 14mm shaft length 61mm $\varnothing$ 116mm H 218mm mounting distance 144.5mm hole $\varnothing$ 6mm |                 |           |
| <b>For models:</b> | GSM-FIVE-STANDARD, GSM-FIVE-STAR, GSM-Quattro-PROFI, GSM-Quattro-STANDARD  |                 |           |

## condensators & interference suppression filters

### operating capacitors

#### plastic



1

|                    |   |                 |           |
|--------------------|---|-----------------|-----------|
| <b>Part No.</b>    | 365146  | <b>Ref. No.</b> | 705.01014 |
| <b>description</b> | operating capacitor capacity 50 $\mu$ F 250V with plastic sheathing tolerance $\pm$ 5% 50/60Hz $\varnothing$ 45mm L 72mm connection male faston 6.3mm |                 |           |
| <b>For models:</b> | GSM-anlikerXL-STANDARD, GSM-anlikerXL-STAR  |                 |           |



|   |   |                 |           |
|---|---|-----------------|-----------|
|  |   |                 |           |
| 1   |   |                 |           |
| <b>Part No.</b>   | 365147  | <b>Ref. No.</b> | 705.01013 |
| <b>description</b>  | operating capacitor capacity 60µF 250V with plastic sheathing tolerance ± 5% 50/60Hz ø 45mm L 96mm connection male faston 6.3mm |                 |           |
| <b>For models:</b>  | GSM-anlikerXL-STANDARD, GSM-anlikerXL-STAR  |                 |           |

|   |   |                 |           |
|---|---|-----------------|-----------|
|  |   |                 |           |
| 1   |   |                 |           |
| <b>Part No.</b>   | 365013  | <b>Ref. No.</b> | 705.01015 |
| <b>description</b>  | operating capacitor capacity 8µF 400V tolerance 5%Hz ambient temperature max. -25 to +85°C ø 31.5mm L 55mm M8 plastic connection male faston 6.3mm protection |                 |           |
| <b>For models:</b>  | GSM-FIVE-STANDARD, GSM-FIVE-STAR, GSM-Quattro-PROFI, GSM-Quattro-STANDARD   |                 |           |

|  |  |                 |           |
|--|--|-----------------|-----------|
| <b>metal</b>   |  |                 |           |
|  |  |                 |           |
| 1  |  |                 |           |
| <b>Part No.</b>  | 365145   | <b>Ref. No.</b> | 705.01001 |
| <b>description</b>   | operating capacitor capacity 8µF 420/470V with metal case tolerance ± 5% 50/60Hz ø 30mm L 108mm connection male faston 6.3mm |                 |           |
| <b>For models:</b>   | GSM-Quattro-PROFI, GSM-Quattro-STANDARD  |                 |           |

**fuses**

**fine fuses**

|   |  |                 |           |
|---|--|-----------------|-----------|
|  |  |                 |           |
| 1   |  |                 |           |
| <b>Part No.</b>   | 358509   | <b>Ref. No.</b> | 710.02007 |
| <b>description</b>  | fine fuse size ø5x20mm 0.05A slow-acting rated 250V Qty 1 pcs                |                 |           |
| <b>For models:</b>  | GSM-anlikerXL-STANDARD, GSM-anlikerXL-STAR, GSM-FIVE-STANDARD, GSM-FIVE-STAR |                 |           |

**miscellaneous**

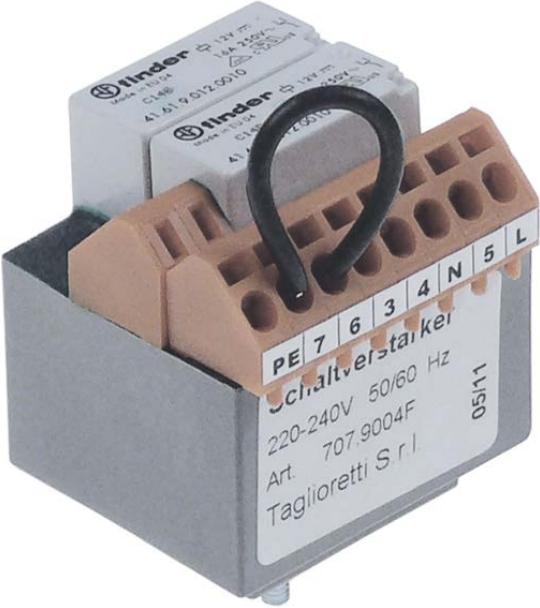
|  |   |                 |           |
|--|---|-----------------|-----------|
|  |   |                 |           |
| 1  |   |                 |           |
| <b>Part No.</b>  | 365148  | <b>Ref. No.</b> | 707.09004 |
| <b>description</b>   | switching amplifier 220-240V 50/60Hz  |                 |           |
| <b>For models:</b>   | GSM-anlikerXL-STANDARD, GSM-anlikerXL-STAR, GSM-FIVE-STANDARD, GSM-FIVE-STAR, GSM-Quattro-PROFI, GSM-Quattro-STANDARD |                 |           |

**equipment-specific units**

**for vegetable slicers**

**press levers**

|  |   |                 |           |
|--|---|-----------------|-----------|
|  |   |                 |           |
| 1  |   |                 |           |
| <b>Part No.</b>  | 699117  | <b>Ref. No.</b> | 235.01608 |
| <b>description</b>   | plunger for vegetable slicer ø 125x55mm L 145mm W 125mm H 255mm |                 |           |
| <b>For models:</b>   | GSM-Quattro-PROFI, GSM-Quattro-STANDARD                         |                 |           |

**ejector discs**

|   |   |                 |           |
|---|---|-----------------|-----------|
|  |   |                 |           |
| 1   |   |                 |           |
| <b>Part No.</b>   | 699121  | <b>Ref. No.</b> | 235.01822 |
| <b>description</b>  | ejector H 21mm seat ø 29mm  |                 |           |
| <b>For models:</b>  | GSM-FIVE-STANDARD, GSM-FIVE-STAR, GSM-Quattro-PROFI, GSM-Quattro-STANDARD |                 |           |



|  |  |                 |           |
|--|--|-----------------|-----------|
|  <p>1</p> |  |                 |           |
| <b>Part No.</b>  | 699114                                       | <b>Ref. No.</b> | 232.01860 |
| <b>description</b>   | ejector disc flat H 33mm ø 180mm seat ø 29mm |                 |           |
| <b>For models:</b>   | GSM-FIVE-STANDARD, GSM-FIVE-STAR             |                 |           |

|  |  |                 |           |
|--|--|-----------------|-----------|
| miscellaneous  |  |                 |           |
|  <p>1</p> |  |                 |           |
| <b>Part No.</b>  | 560466   | <b>Ref. No.</b> | 812.50960 |
| <b>description</b>   | adjusting washer ID ø 37mm ED ø 47mm thickness 0.1mm steel Qty 1 pcs DIN 988 |                 |           |
| <b>For models:</b>   | GSM-FIVE-STANDARD, GSM-FIVE-STAR   |                 |           |

|  |  |                 |           |
|--|--|-----------------|-----------|
|  <p>1</p> |  |                 |           |
| <b>Part No.</b>  | 699122   | <b>Ref. No.</b> | 235.02604 |
| <b>description</b>   | bolt ø 9mm L 35mm thread M8x1.25 SS for vegetable slicer                     |                 |           |
| <b>For models:</b>   | GSM-anlikerXL-STANDARD, GSM-anlikerXL-STAR, GSM-FIVE-STANDARD, GSM-FIVE-STAR |                 |           |

|  |  |                 |           |
|--|--|-----------------|-----------|
|  <p>1</p> |  |                 |           |
| <b>Part No.</b>  | 699116                                       | <b>Ref. No.</b> | 235.01607 |
| <b>description</b>   | bush ED ø 16mm ID ø 9.3mm L 15.5mm for catch |                 |           |
| <b>For models:</b>   | GSM-Quattro-PROFI, GSM-Quattro-STANDARD      |                 |           |

|  |  |                 |           |
|--|--|-----------------|-----------|
|  <p>1</p> |  |                 |           |
| <b>Part No.</b>  | 699123   | <b>Ref. No.</b> | 235.02605 |
| <b>description</b>   | bush ED ø 16mm ID ø 9.3mm L 21mm plastic for catch                           |                 |           |
| <b>For models:</b>   | GSM-anlikerXL-STANDARD, GSM-anlikerXL-STAR, GSM-FIVE-STANDARD, GSM-FIVE-STAR |                 |           |

|   |   |                 |           |
|---|---|-----------------|-----------|
|  <p>1</p> |   |                 |           |
| <b>Part No.</b>   | 699125  | <b>Ref. No.</b> | 235.02620 |
| <b>description</b>  | flange ED ø 159mm ID ø 120mm H 101mm aluminium for vegetable slicer       |                 |           |
| <b>For models:</b>  | GSM-FIVE-STANDARD, GSM-FIVE-STAR, GSM-Quattro-PROFI, GSM-Quattro-STANDARD |                 |           |

|   |   |                 |           |
|---|---|-----------------|-----------|
|  <p>1</p> |   |                 |           |
| <b>Part No.</b>   | 699127  | <b>Ref. No.</b> | 733.05002 |
| <b>description</b>  | gearbox ED ø 109mm ID ø 87mm H 16mm plastic for vegetable slicer          |                 |           |
| <b>For models:</b>  | GSM-FIVE-STANDARD, GSM-FIVE-STAR, GSM-Quattro-PROFI, GSM-Quattro-STANDARD |                 |           |

|  |  |                 |           |
|--|--|-----------------|-----------|
|  <p>1</p> |  |                 |           |
| <b>Part No.</b>  | 699115   | <b>Ref. No.</b> | 235.01120 |
| <b>description</b>   | hinge pin ø 8mm L 25mm SS for vegetable slicer |                 |           |
| <b>For models:</b>   | GSM-Quattro-PROFI, GSM-Quattro-STANDARD        |                 |           |

|   |  |                 |           |
|---|--|-----------------|-----------|
|  <p>1</p> |  |                 |           |
| <b>Part No.</b>   | 699124   | <b>Ref. No.</b> | 235.02619 |
| <b>description</b>  | planet gear ø 45mm H 41mm thread M6 mounting distance 45mm for gearbox |                 |           |
| <b>For models:</b>  | GSM-FIVE-STANDARD, GSM-FIVE-STAR                                       |                 |           |

|   |  |                 |           |
|---|--|-----------------|-----------|
|  <p>1</p> |  |                 |           |
| <b>Part No.</b>   | 699118                                     | <b>Ref. No.</b> | 235.01644 |
| <b>description</b>  | shaft ø 5mm L 43.5mm thread M5 for plunger |                 |           |
| <b>For models:</b>  | GSM-Quattro-PROFI, GSM-Quattro-STANDARD    |                 |           |



1

|                    |  |                 |           |
|--------------------|--|-----------------|-----------|
| <b>Part No.</b>    | 699128   | <b>Ref. No.</b> | 735.01026 |
| <b>description</b> | shaft sealing ED $\varnothing$ 40mm ID $\varnothing$ 30mm H 7mm plastic for vegetable slicer |                 |           |
| <b>For models:</b> | GSM-anlikerXL-STANDARD, GSM-anlikerXL-STAR, GSM-FIVE-STANDARD, GSM-FIVE-STAR                 |                 |           |



1

|                    |   |                 |           |
|--------------------|---|-----------------|-----------|
| <b>Part No.</b>    | 699120  | <b>Ref. No.</b> | 235.01811 |
| <b>description</b> | slide bearing ED $\varnothing$ 68mm ID $\varnothing$ 60mm H 10mm plastic for vegetable slicer |                 |           |
| <b>For models:</b> | GSM-FIVE-STAR   |                 |           |



1

|                    |   |                 |           |
|--------------------|---|-----------------|-----------|
| <b>Part No.</b>    | 699119  | <b>Ref. No.</b> | 235.01645 |
| <b>description</b> | thread bolt $\varnothing$ 8mm L 30mm thread M5 SS for catch |                 |           |
| <b>For models:</b> | GSM-Quattro-PROFI, GSM-Quattro-STANDARD                     |                 |           |



1

|                    |   |                 |           |
|--------------------|---|-----------------|-----------|
| <b>Part No.</b>    | 699126  | <b>Ref. No.</b> | 731.03001 |
| <b>description</b> | Thumb screw $\varnothing$ 19mm L 24mm thread M5 SS/plastic for vegetable slicer |                 |           |
| <b>For models:</b> | GSM-Quattro-PROFI, GSM-Quattro-STANDARD   |                 |           |

## gaskets

### O-rings

#### EPDM

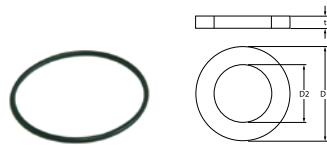

1

|                    |   |                 |           |
|--------------------|---|-----------------|-----------|
| <b>Part No.</b>    | 512114  | <b>Ref. No.</b> | 825.20384 |
| <b>description</b> | O-ring EPDM thickness 2.62mm ID $\varnothing$ 55.25mm Qty 1 pcs |                 |           |
| <b>For models:</b> | GSM-FIVE-STAR, GSM-Quattro-PROFI                                |                 |           |

## shaft gaskets

### shaft gaskets



1

|                    |  |                 |           |
|--------------------|--|-----------------|-----------|
| <b>Part No.</b>    | 699128   | <b>Ref. No.</b> | 735.01026 |
| <b>description</b> | shaft sealing ED $\varnothing$ 40mm ID $\varnothing$ 30mm H 7mm plastic for vegetable slicer |                 |           |
| <b>For models:</b> | GSM-anlikerXL-STANDARD, GSM-anlikerXL-STAR, GSM-FIVE-STANDARD, GSM-FIVE-STAR                 |                 |           |

## transmission technology and ball bearings

### ball bearings

#### deep-groove ball bearings 2RS



1

|                    |  |                 |           |
|--------------------|--|-----------------|-----------|
| <b>Part No.</b>    | 523525   | <b>Ref. No.</b> | 823.30373 |
| <b>description</b> | deep-groove ball bearing type 6005-2RS shaft $\varnothing$ 25mm ED $\varnothing$ 47mm W 12mm with sealing discs deep-groove ball bearing DIN 625-1 |                 |           |
| <b>For models:</b> | GSM-FIVE-STANDARD, GSM-FIVE-STAR   |                 |           |

#### angular contact ball bearings



1

|                    |  |                 |           |
|--------------------|--|-----------------|-----------|
| <b>Part No.</b>    | 523017   | <b>Ref. No.</b> | 823.20473 |
| <b>description</b> | angular contact ball bearing shaft $\varnothing$ 30mm ED $\varnothing$ 55mm W 19mm type 3006-2RS DIN 628 |                 |           |
| <b>For models:</b> | GSM-anlikerXL-STANDARD, GSM-anlikerXL-STAR   |                 |           |



## fastening material

## screws

## cylinder head bolts

DIN 912/ISO 4762



1

|                    |   |                 |           |
|--------------------|---|-----------------|-----------|
| <b>Part No.</b>    | 560030  | <b>Ref. No.</b> | 801.30232 |
| <b>description</b> | cylinder head bolt thread M5 thread L 25mm WS 4 SS Qty 20 pcs DIN 912/ISO 4762  |                 |           |
| <b>For models:</b> | GSM-anlikerXL-STANDARD, GSM-anlikerXL-STAR, GSM-FIVE-STANDARD, GSM-FIVE-STAR, GSM-Quattro-PROFI, GSM-Quattro-STANDARD |                 |           |

## side bolts



1

|                    |   |                 |           |
|--------------------|---|-----------------|-----------|
| <b>Part No.</b>    | 560053  | <b>Ref. No.</b> | 802.30102 |
| <b>description</b> | side bolts thread M5 L 16mm SS Qty 20 pcs intake slotted head $\phi$ 12.5mm   |                 |           |
| <b>For models:</b> | GSM-anlikerXL-STANDARD, GSM-anlikerXL-STAR, GSM-FIVE-STANDARD, GSM-FIVE-STAR, GSM-Quattro-PROFI, GSM-Quattro-STANDARD |                 |           |

## grub screws

DIN 914/ISO 4027



1

|                    |  |                 |           |
|--------------------|--|-----------------|-----------|
| <b>Part No.</b>    | 560169   | <b>Ref. No.</b> | 808.60018 |
| <b>description</b> | grub screw thread M3 L 4mm DIN 914/ISO 4027 WS 1.5 Qty 1 pcs |                 |           |
| <b>For models:</b> | GSM-FIVE-STANDARD, GSM-FIVE-STAR                             |                 |           |

## knurled screws



1

|                    |  |                 |           |
|--------------------|--|-----------------|-----------|
| <b>Part No.</b>    | 699126   | <b>Ref. No.</b> | 731.03001 |
| <b>description</b> | Thumb screw $\phi$ 19mm L 24mm thread M5 SS/plastic for vegetable slicer |                 |           |
| <b>For models:</b> | GSM-Quattro-PROFI, GSM-Quattro-STANDARD                                  |                 |           |

## nuts

## hexagonal nuts

DIN 934 / ISO 4032/8673



1

|                    |   |                 |           |
|--------------------|---|-----------------|-----------|
| <b>Part No.</b>    | 560131  | <b>Ref. No.</b> | 810.10022 |
| <b>description</b> | hexagonal nut thread M4 H 3.2mm WS 7 SS DIN/ISO DIN 934 / ISO 4032/8673 Qty 20 pcs                                    |                 |           |
| <b>For models:</b> | GSM-anlikerXL-STANDARD, GSM-anlikerXL-STAR, GSM-FIVE-STANDARD, GSM-FIVE-STAR, GSM-Quattro-PROFI, GSM-Quattro-STANDARD |                 |           |



1

|                    |   |                 |           |
|--------------------|---|-----------------|-----------|
| <b>Part No.</b>    | 560132  | <b>Ref. No.</b> | 810.10032 |
| <b>description</b> | hexagonal nut thread M5 H 4mm WS 8 SS DIN/ISO DIN 934 / ISO 4032/8673 Qty 20 pcs                                      |                 |           |
| <b>For models:</b> | GSM-anlikerXL-STANDARD, GSM-anlikerXL-STAR, GSM-FIVE-STANDARD, GSM-FIVE-STAR, GSM-Quattro-PROFI, GSM-Quattro-STANDARD |                 |           |



1

|                    |   |                 |           |
|--------------------|---|-----------------|-----------|
| <b>Part No.</b>    | 560134  | <b>Ref. No.</b> | 810.10052 |
| <b>description</b> | hexagonal nut thread M8 H 6.5mm WS 13 SS DIN/ISO DIN 934 / ISO 4032/8673 Qty 20 pcs                                   |                 |           |
| <b>For models:</b> | GSM-anlikerXL-STANDARD, GSM-anlikerXL-STAR, GSM-FIVE-STANDARD, GSM-FIVE-STAR, GSM-Quattro-PROFI, GSM-Quattro-STANDARD |                 |           |

## washers

## spring rings



1

|                    |  |                 |           |
|--------------------|--|-----------------|-----------|
| <b>Part No.</b>    | 560122   | <b>Ref. No.</b> | 814.10039 |
| <b>description</b> | lock washer ID $\phi$ 5.2mm ED $\phi$ 9mm SS DIN127 Qty 20 pcs for thread M5 |                 |           |
| <b>For models:</b> | GSM-FIVE-STANDARD, GSM-FIVE-STAR, GSM-Quattro-PROFI, GSM-Quattro-STANDARD    |                 |           |



1

|                    |   |                 |           |
|--------------------|---|-----------------|-----------|
| <b>Part No.</b>    | 560124  | <b>Ref. No.</b> | 814.10059 |
| <b>description</b> | lock washer ID $\phi$ 8.3mm ED $\phi$ 15mm SS DIN127 Qty 20 pcs for thread M8 |                 |           |
| <b>For models:</b> | GSM-FIVE-STANDARD, GSM-FIVE-STAR, GSM-Quattro-PROFI, GSM-Quattro-STANDARD     |                 |           |





## washers

## DIN 125A



1

|                    |   |                 |           |
|--------------------|---|-----------------|-----------|
| <b>Part No.</b>    | 560111  | <b>Ref. No.</b> | 812.60032 |
| <b>description</b> | plain washer ID $\varnothing$ 4.3mm ED $\varnothing$ 9mm thickness 0.8mm SS Qty 20 pcs DIN 125A for thread M4 |                 |           |
| <b>For models:</b> | GSM-FIVE-STANDARD, GSM-FIVE-STAR, GSM-Quattro-PROFI, GSM-Quattro-STANDARD                                     |                 |           |



1

|                    |   |                 |           |
|--------------------|---|-----------------|-----------|
| <b>Part No.</b>    | 560112  | <b>Ref. No.</b> | 812.10032 |
| <b>description</b> | plain washer ID $\varnothing$ 5.3mm ED $\varnothing$ 10mm thickness 1mm SS Qty 20 pcs DIN 125A for thread M5          |                 |           |
| <b>For models:</b> | GSM-anlikerXL-STANDARD, GSM-anlikerXL-STAR, GSM-FIVE-STANDARD, GSM-FIVE-STAR, GSM-Quattro-PROFI, GSM-Quattro-STANDARD |                 |           |



1

|                    |  |                 |           |
|--------------------|--|-----------------|-----------|
| <b>Part No.</b>    | 560114   | <b>Ref. No.</b> | 812.10052 |
| <b>description</b> | plain washer ID $\varnothing$ 8.4mm ED $\varnothing$ 16mm thickness 1.6mm SS Qty 20 pcs DIN 125A for thread M8 |                 |           |
| <b>For models:</b> | GSM-anlikerXL-STANDARD, GSM-anlikerXL-STAR, GSM-FIVE-STANDARD, GSM-FIVE-STAR                                   |                 |           |

## adjusting washer (DIN 988)



1

|                    |  |                 |           |
|--------------------|--|-----------------|-----------|
| <b>Part No.</b>    | 560466   | <b>Ref. No.</b> | 812.50960 |
| <b>description</b> | adjusting washer ID $\varnothing$ 37mm ED $\varnothing$ 47mm thickness 0.1mm steel Qty 1 pcs DIN 988 |                 |           |
| <b>For models:</b> | GSM-FIVE-STANDARD, GSM-FIVE-STAR   |                 |           |

## tooth lock washers

## DIN 6798A



1

|                    |   |                 |           |
|--------------------|---|-----------------|-----------|
| <b>Part No.</b>    | 560125  | <b>Ref. No.</b> | 814.20022 |
| <b>description</b> | tooth lock washer ID $\varnothing$ 4.2mm ED $\varnothing$ 8mm SS DIN/ISO DIN 6798A Qty 20 pcs for thread M4 |                 |           |
| <b>For models:</b> | GSM-FIVE-STANDARD, GSM-FIVE-STAR, GSM-Quattro-PROFI, GSM-Quattro-STANDARD                                   |                 |           |



1

|                    |  |                 |           |
|--------------------|--|-----------------|-----------|
| <b>Part No.</b>    | 560128   | <b>Ref. No.</b> | 814.20052 |
| <b>description</b> | tooth lock washer ID $\varnothing$ 8.3mm ED $\varnothing$ 15mm SS DIN/ISO DIN 6798A Qty 20 pcs for thread M8 |                 |           |
| <b>For models:</b> | GSM-FIVE-STANDARD, GSM-FIVE-STAR, GSM-Quattro-PROFI, GSM-Quattro-STANDARD                                    |                 |           |

## fasteners

## retaining rings

## DIN 471



1

|                    |   |                 |           |
|--------------------|---|-----------------|-----------|
| <b>Part No.</b>    | 519248  | <b>Ref. No.</b> | 815.20082 |
| <b>description</b> | retaining ring shaft $\varnothing$ 10mm thickness 1mm SS DIN 471          |                 |           |
| <b>For models:</b> | GSM-FIVE-STANDARD, GSM-FIVE-STAR, GSM-Quattro-PROFI, GSM-Quattro-STANDARD |                 |           |

## DIN 472



1

|                    |  |                 |           |
|--------------------|--|-----------------|-----------|
| <b>Part No.</b>    | 523102   | <b>Ref. No.</b> | 815.10314 |
| <b>description</b> | retaining ring bore $\varnothing$ 47mm thickness 1.8mm steel DIN 472 |                 |           |
| <b>For models:</b> | GSM-FIVE-STANDARD, GSM-FIVE-STAR                                     |                 |           |

## DIN 6799



1

|                    |  |                 |           |
|--------------------|--|-----------------|-----------|
| <b>Part No.</b>    | 529268   | <b>Ref. No.</b> | 815.30112 |
| <b>description</b> | retaining ring E D1 $\varnothing$ 9mm D2 $\varnothing$ 18mm stainless steel DIN 6799 thickness 1.1mm for shaft $\varnothing$ 10-14mm |                 |           |
| <b>For models:</b> | GSM-FIVE-STAR  |                 |           |

## consumables

## fuses

## fine fuses



1

|                    |  |                 |           |
|--------------------|--|-----------------|-----------|
| <b>Part No.</b>    | 358509   | <b>Ref. No.</b> | 710.02007 |
| <b>description</b> | fine fuse size $\varnothing$ 5x20mm 0.05A slow-acting rated 250V Qty 1 pcs   |                 |           |
| <b>For models:</b> | GSM-anlikerXL-STANDARD, GSM-anlikerXL-STAR, GSM-FIVE-STANDARD, GSM-FIVE-STAR |                 |           |

**GASTRO**PARTS.COM

