



GASTROPARTS

MKN Ovens

[EN] Cooking

[DE] Kochtechnik

[ES] Cocción

[FR] Cuisson

[IT] Cottura

[PL] Obróbka termiczna

[RU] Термическая обработка

✉ gastroparts@gastroparts.com

☎ tel. +48 56 657 00 66

📘 fb.com/gastroparts.global

GASTROPARTS.COM





heating elements

heating elements for convection



1

| | | | |
|--------------------|--|-----------------|--------|
| Part No. | 419248 | Ref. No. | 574183 |
| description | heating element 15300W 400V heating circuits 6 ID \varnothing 450mm ED \varnothing 530mm L 540mm H 113mm W1 96mm H1 23mm H2 90mm flange length 130mm flange width 70mm connection length 100mm tube \varnothing 6.5mm cable length 1200mm dry heating element with fixing flange | | |



1

| | | | |
|---|--|-----------------|------------------------|
| Part No. | 418750 | Ref. No. | 574177 |
| description | heating element 15400W 400V heating circuits 6 ID \varnothing 450mm ED \varnothing 530mm L 540mm H 113mm W1 96mm H1 23mm H2 90mm flange length 130mm flange width 70mm connection length 100mm tube \varnothing 6.5mm cable length 1200mm dry heating element with fixing flange | | |
| accessories for | 418750 | | |
|  | Part No. | 550639 | Ref. No. 211083 |
| | gasket L 130mm W 70mm thickness 1mm for heating element | | |



1

| | | | |
|---|---|-----------------|------------------------|
| Part No. | 418748 | Ref. No. | 574181 |
| description | heating element 20400W 400V heating circuits 6 ID \varnothing 450mm ED \varnothing 525mm L 107mm H 113mm W1 97mm H1 28mm H2 85mm flange length 130mm flange width 70mm hole distance 119mm connection length 100mm tube \varnothing 6.5mm cable length 1200mm dry heating element hole \varnothing 6mm with fixing flange | | |
| accessories for | 418748 | | |
|  | Part No. | 550639 | Ref. No. 211083 |
| | gasket L 130mm W 70mm thickness 1mm for heating element | | |



1

| | | | |
|--------------------|---|-----------------|--------|
| Part No. | 418751 | Ref. No. | 574189 |
| description | heating element 30000W 400V heating circuits 6 ID \varnothing 380mm ED \varnothing 450mm L 535mm H 120mm W1 99mm H1 20mm H2 100mm flange length 130mm flange width 70mm connection length 100mm tube \varnothing 8mm cable length 1200mm dry heating element with fixing flange | | |



1

| | | | |
|---|---|-----------------|------------------------|
| Part No. | 418749 | Ref. No. | 574176 |
| description | heating element 9900W 400V heating circuits 3 ID \varnothing 450mm ED \varnothing 465mm L 500mm H 115mm L1 35mm W1 96mm H1 26mm H2 89mm flange length 130mm flange width 70mm connection length 100mm tube \varnothing 6.5mm cable length 1200mm dry heating element with fixing flange | | |
| accessories for | 418749 | | |
|  | Part No. | 550639 | Ref. No. 211083 |
| | gasket L 130mm W 70mm thickness 1mm for heating element | | |

energy regulators

EGO

1-circuit



1

| | | | |
|--------------------|---|-----------------|--------|
| Part No. | 380015 | Ref. No. | 203160 |
| description | energy regulator 230V 13A single-circuit turn direction right shaft \varnothing 6x4.6mm shaft L 23mm mounting thread M4 power release 6-100% no. 50.57021.010 | | |



thermostats

bi-metal thermostats

safety bi-metal thermostats



| | | | |
|--------------------|--|-----------------|--------|
| 1 | | | |
| Part No. | 378659 | Ref. No. | 202806 |
| description | bi-metal safety thermostat hole distance 24mm switch-off temp. 320°C NC 1-pole 16A 400V connection with cable cable length 120mm with fixing sheet | | |

bi-metal thermostats



| | | | |
|--------------------|--|-----------------|--------|
| 1 | | | |
| Part No. | 390767 | Ref. No. | 203523 |
| description | bi-metal thermostat switch-off temp. 60°C 1NC 1-pole connection F6.3 | | |

control and safety thermostats

EGO

control thermostats

55.13_ series



| | | | |
|--------------------|--|-----------------|------------------|
| 1 | | | |
| Part No. | 375747 | Ref. No. | 203067 203662 |
| description | thermostat t.max. 190°C temperature range 97-190°C 1-pole 1N0 16A probe ø 6mm probe L 87mm capillary pipe 1430mm capillary pipe isolated 1100mm gland nut M9x1 shaft ø ø6x4.6mm shaft L 23mm shaft position upper rotation 270° | | |
| For models: | 2020301-01, 2020301-02, 2020301A01, 2020301A02, 2020301A03, 2020301B01, 2020301C01, 2020302-01, 2020302-02, 2020302-03, 2020302-04, 2020302-05, 2020302A01, 2020302A02, 2020302A03, 2020302A04, 2020302A05, 2020302B01, 2020302C01, 3020301-01, 3020301-02, 3020301B01, 3020302-01, 3020302-02, 3020302-03, 3020302-04, 3020302B01 | | |



| | | | |
|--------------------|---|-----------------|------------------|
| 1 | | | |
| Part No. | 375505 | Ref. No. | 203177 203500 |
| description | thermostat t.max. 320°C temperature range 50-320°C 1-pole 1N0 16A probe ø 3mm probe L 160mm capillary pipe 870mm capillary pipe isolatedmm gland nut shaft ø ø6x4.6mm shaft L 23mm shaft position upper rotation 270° | | |

55.34_ series





| | | | |
|--------------------|---|-----------------|--------|
| 1 | | | |
| Part No. | 375025 | Ref. No. | 203488 |
| description | thermostat t.max. 300°C temperature range 50-300°C 3-pole 3C0 16A probe ø 6mm probe L 77mm capillary pipe 2980mm capillary pipe isolated 2260mm gland nut shaft ø ø6x4.6mm shaft L 23mm shaft position upper rotation 270° | | |
| For models: | 2021401-00, 2021401-01, 2021401-02, 2021401-03, 2021401-04, 2021401-05, 2021401-06, 2021401-07, 2021401A00, 2021401A01, 2021401A02, 2021401A03, 2021401A04, 2021401B00, 2021401B01, 2021401B02, 2021401B03, 2021401B04, 2021401C00, 2021401C01, 2021401C02, 2021401C03, 2021401C04, 2021402-00, 2021402-01, 2021402-02, 2021402-03, 2021402-04, 2021402-05, 2021402-06, 2021402-07, 2021402A00, 2021402A01, 2021402A02, 2021402A03, 2021402A04, 2021402B00, 2021402B01, 2021402B02, 2021402B03, 2021402B04, 2021402C00, 2021402C01, 2021402C02, 2021402C03, 2021402C04, 2021403-00, 2021403-01, 2021403-02, 2021403-03... (Other models you can see in the webshop) | | |

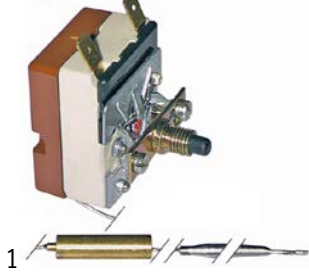

safety thermostats

55.13_ series



| | | | |
|---|---|-----------------|------------------------|
| Part No. | 375044 | Ref. No. | 203185 |
| description | safety thermostat switch-off temp. 178°C 1-pole 16A probe ø 4mm probe L 91mm capillary pipe 1730mm capillary pipe isolated 1600mm gland nut probe with sealing sleeve screw connection M8x1 sealing sleeve 8.6x32mm | | |
| accessories for | 375044 | | |
|  | Part No. | 102067 | Ref. No. 201524 |
| | nut thread M8x1 H 3mm brass Qty 1 pcs type SEF 1 | | |
|  | Part No. | 551083 | Ref. No. — |
| | cap for safety thermostat thread M8x1 | | |

55.32_ series



| | | | |
|--------------------|--|-----------------|--------|
| Part No. | 375392 | Ref. No. | 203484 |
| description | safety thermostat switch-off temp. 360°C 3-pole 1CO/2NC 20A probe ø 4mm probe L 120mm capillary pipe 1490mm capillary pipe isolated 1450mm gland nut probe SS | | |
| For models: | 2021101-00, 2021101A00, 2021102-00, 2021103-00, 2021104-00, 2021104A00, 2021105-00, 2021106-00, 2021107-00, 2021107-01, 2021107A00, 2021108-00, 2021109-00, 2021109-01, 2021109A00, 2021110-00, 2021111-01, 2021111-02, 2021112-00, 2021112-01, 20211401-02, 20211401-03, 2021401-04, 2021401-05, 2021401-06, 2021401-07, 2021401A01, 2021401A02, 2021401A03, 2021401A04, 2021401B01, 2021401B02, 2021401B03, 2021401B04, 2021401C01, 2021401C02, 2021401C03, 2021401C04, 2021402-02, 2021402-03, 2021402-04, 2021402-05, 2021402-06, 2021402-07, 2021402A01, 2021402A02, 2021402A03, 2021402A04, 2021402B01, 2021402B02... (Other models you can see in the webshop) | | |

control thermostats with operation switch

55.34_ series

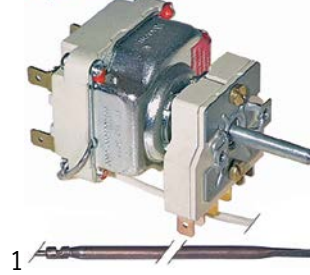

| | | | |
|--------------------|---|-----------------|--------|
| Part No. | 375246 | Ref. No. | 203408 |
| description | thermostat t.max. 645°C temperature range 100-615/645°C 2-pole 2NO 16A probe ø 4mm probe L 230mm capillary pipe 1100mm capillary pipe isolated 600mm gland nut shaft ø 6x4.6mm shaft L 25mm shaft position lower rotation 270° outer switch 2NO probe material copper | | |
| For models: | 2023206-00, 2023206-01, 2023207-00, 2023207-01, 2023207-02, 2023207-03, 2023207-04, 3023206-00, 3023206-01 | | |

accessories

probe clips

clamps

for thermostat



| | | | |
|--------------------|--|-----------------|------------------|
| Part No. | 550878 | Ref. No. | 208057 575077 |
| description | probe clip for pipe ømm for probe ø 6mm Qty 1 pcs | | |
| For models: | 2020303-02, 2020303-03, 2020303-04, 2020303A00, 2020501-0, 2020501-00, 2020501-01, 2020503-0, 2020504-00, 2020505-00, 2022801-02, 2022801-03, 2022801A02, 2022801B02, 2022801B03, 2022802-02, 2022802-03, 2022802A02, 2022802A03, 2022802B02, 2022802B03, 2022802B04, 2022802B05, 2022802C02, 2022802C03, 2022803-02, 2022803-03, 2022803A02, 2022803A03, 2022803B02, 2022803B03, 2022803C02, 2022803C03, 2022804-02, 2022804-03, 2022804A02, 2022804A03, 2022804B02, 2022804B03, 2022804B04, 2022804B05, 2022804C02, 2022804C03, 2022805-02, 2022805-03, 2022805A02, 2022805A03, 2022805B02, 2022805B03, 2022805B04... (Other models you can see in the webshop) | | |

protective pipes for capillary pipes



| | | | |
|--------------------|--|-----------------|--------|
| Part No. | 550385 | Ref. No. | 541673 |
| description | protective pipe for capillaries thread M10x1 H1 120mm L1 50mm L2 125mm | | |



| | | | |
|--------------------|--|-----------------|--------|
| Part No. | 550386 | Ref. No. | 541674 |
| description | protective pipe for capillaries thread M10x1 H1 148mm L1 46mm L2 100mm | | |



plunger sockets

| | | | |
|--|---|-----------------|------------------|
|  <p>1</p> | | | |
| Part No. | 550285 | Ref. No. | 541221 935211 |
| description | protection pipe thread M12x0.75 IT M9x1 ET M12x0.75 L 66mm SS single ø 10mm | | |
| For models: | 2020501-0, 2020501-00, 2020501-01, 2020502-00, 2020503-0, 2020504-00, 2020505-00, 2060501-0, 2060501-00, 2060501-01, 3020501-00, 3020502-00, 3020505-00 | | |

switches and momentary switches

rocker/momentary rocker switches

30x22mm

| | | | |
|--|---|-----------------|--------|
|  <p>1</p> | | | |
| Part No. | 301060 | Ref. No. | 203235 |
| description | rocker switch mounting measurements 30x22mm red 2NO 250V 16A illuminated connection male faston 6.3mm ambient temperature max. 125/55°C protection IP40 | | |
| For models: | 2062801-00, 2062801A00, 2062801B00, 2062801C00, 2062802-00, 2062802-2, 2062802A00, 2062802B00, 2062802C00, 2062803-00, 2062803-1, 2062803-2, 2062803A00, 2062803C00, 2062804-00, 2062804-1, 2062804-2, 2062804A00, 2062804B00, 2062804C00, 2062806-00, 2062806A00, 2062806B00, 2062806B01, 2062806B02, 2062806C00, 2062806C01, 2062806C02, 2062901-00, 2062901-1, 2062901-2, 2062901A00, 2062901B00, 2062901B01, 2062901B02, 2062901C00, 2062901C01, 2062901C02, 2062902-00, 2062902-1, 2062902-2, 2062902A00, 2062902B00, 2062902B01, 2062902B02, 2062902C00, 2062902C01, 2062902C02 | | |

accessories

push buttons

| | | | |
|--|---|-----------------|--------|
|  <p>1</p> | | | |
| Part No. | 348214 | Ref. No. | 207186 |
| description | button for display PCB transparent suitable for MKN ED ø 16mm H 4.8mm for combi-steamer | | |

cam switches

on/off

| | | | |
|---|--|-----------------|--------|
|  <p>1</p> | | | |
| Part No. | 347953 | Ref. No. | 203958 |
| description | cam switch 4 operating positions 2NO sequence 0-1-0-1 16A shaft ø 6x4.6mm shaft L 23mm connection male faston 6.3mm ON-OFF plastic | | |

7-position

| | | | |
|---|---|-----------------|--------|
|  <p>1</p> | | | |
| Part No. | 300106 | Ref. No. | 203560 |
| description | cam switch 7 operating positions 1NO/2CO sequence 0-1-2-3-4-5-6 32A shaft ø 6x4.6mm shaft L 23mm connection screw 7-position shaft flat upper | | |

magnetic switches

28.5x19mm

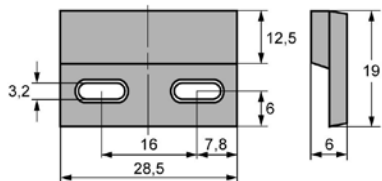
| | | | |
|---|--|-----------------|--------|
|   <p>1</p> | | | |
| Part No. | 345219 | Ref. No. | 203028 |
| description | magnetic switch L 28.5mm W 19mm 1NO 230V 0.5A P max. 10W connection cable cable length 800mm | | |



29x19mm



1

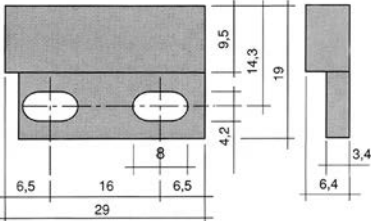

| | | | |
|--------------------|---|-----------------|--------|
| Part No. | 345808 | Ref. No. | 202722 |
| description | magnetic switch L 29mm W 19mm 1CO 150V 0.5A P max. 10W connection cable cable length 1000mm | | |

encoders and potentiometers



1

| | | | |
|--------------------|---------------------------------------|-----------------|--------|
| Part No. | 401968 | Ref. No. | 203733 |
| description | potentiometer with momentary function | | |

lamps

screw-on/push-on fit

halogen lamp

for socket G4 / G6.35 / G9



1

| | | | |
|--------------------|--|-----------------|--------|
| Part No. | 357191 | Ref. No. | 202620 |
| description | halogen lamp socket G4 12V 10W temp.-resist. 300°C OSRAM HALOSTAR OVEN | | |



1

| | | | |
|--------------------|--|-----------------|--------|
| Part No. | 359599 | Ref. No. | 203679 |
| description | halogen lamp socket G4 12V 20W temp.-resist. 500°C | | |

oven lamps

producer-specific oven lamps

MKN



1

| | | | |
|--------------------|--|-----------------|--------|
| Part No. | 693050 | Ref. No. | 211128 |
| description | gasket graphite D1 ø 71mm D2 ø 94mm thickness 1mm suitable for MKN Qty 1 pcs | | |

| | | | | | |
|------------------------|----------------------------------|-----------------|--------|-----------------|--------|
| accessories for | 693050 | Part No. | 694294 | Ref. No. | 216115 |
| | glass panel ø 90mm thickness 8mm | | | | |



1

| | | | |
|--------------------|----------------------------------|-----------------|--------|
| Part No. | 694294 | Ref. No. | 216115 |
| description | glass panel ø 90mm thickness 8mm | | |

| | | | | | |
|------------------------|--|-----------------|--------|-----------------|--------|
| accessories for | 694294 | Part No. | 693050 | Ref. No. | 211128 |
| | gasket graphite D1 ø 71mm D2 ø 94mm thickness 1mm suitable for MKN Qty 1 pcs | | | | |

| | | | |
|--------------------|--|-----------------|--------|
| Part No. | 699482 | Ref. No. | 211146 |
| description | gasket suitable for MKN combi-steamer mounting pos. for lens ED ø 105mm ID ø 71mm graphite thickness 1mm | | |



1

| | | | |
|--------------------|--|-----------------|--------|
| Part No. | 357184 | Ref. No. | 203678 |
| description | lamp socket socket G4 cable length 130mm connection male faston 6.3mm ø 17mm H 9mm mounting distance 12mm mounting thread M3 Qty 1 pcs | | |

lamps

halogen lamps

for socket G4 / G6.35 / G9



1

| | | | |
|--------------------|--|-----------------|--------|
| Part No. | 357191 | Ref. No. | 202620 |
| description | halogen lamp socket G4 12V 10W temp.-resist. 300°C OSRAM HALOSTAR OVEN | | |



| | | | |
|---|--|-----------------|--------|
|  | | | |
| 1 | | | |
| Part No. | 359599 | Ref. No. | 203679 |
| description | halogen lamp socket G4 12V 20W temp.-resist. 500°C | | |

alarm devices

buzzers

| | | | |
|---|--|-----------------|--------|
|  | | | |
| 1 | | | |
| Part No. | 350050 | Ref. No. | 203325 |
| description | buzzer 230VAC connection male faston 6.3mm screw mounting thread M4 60dB | | |

| | | | |
|---|--|-----------------|--------|
|  | | | |
| 1 | | | |
| Part No. | 350221 | Ref. No. | 202775 |
| description | buzzer 5-28VDC connection F6.3 mounting ø 40mm | | |

contactors

TELEMECANIQUE (Schneider Electric)

power contactors

| | | | |
|---|--|-----------------|--------|
|  | | | |
| 1 | | | |
| Part No. | 381484 | Ref. No. | 203986 |
| description | power contactor resistive load 125A 230 (AC3/400V) 37kW main contacts 3NO auxiliary contacts 1NO/1NC connection screw type LC1D80116 | | |

| | | | |
|--|---|-----------------|--------|
|  | | | |
| 1 | | | |
| Part No. | 381486 | Ref. No. | 203971 |
| description | power contactor resistive load 20A (AC3/400V) 4kW main contacts 2x3NO auxiliary contacts 2x1NO connection screw type LC2K0910P7 | | |

| | | | |
|--|---|-----------------|--------|
|  | | | |
| 1 | | | |
| Part No. | 380965 | Ref. No. | 203744 |
| description | power contactor resistive load 20A 230VAC (AC3/400V) 6A/2.2kW main contacts 3NO auxiliary contacts 1NO connection screw connection type LC1K0610P7+ | | |

| | | | |
|---|---|-----------------|--------|
|  | | | |
| 1 | | | |
| Part No. | 380976 | Ref. No. | 203675 |
| description | power contactor resistive load 32A 230VAC (AC3/400V) 18A/7.5kW main contacts 3NO auxiliary contacts 1NO/1NC connection screw connection | | |

| | | | |
|--|--|-----------------|--------|
|  | | | |
| 1 | | | |
| Part No. | 380980 | Ref. No. | 203985 |
| description | power contactor resistive load 50A 230VAC (AC3/400V) 32A/15kW main contacts 3NO auxiliary contacts 1NO/1NC connection screw connection type LC1D32P7 | | |



TRIPUS (Eichhoff)

small relay switches



1

| | | | |
|--------------------|---|-----------------|--------|
| Part No. | 380121 | Ref. No. | 203219 |
| description | small relay switch 230V main contacts 3NO/1NC auxiliary contacts knob ø70mm (227-piece) connection Faston 6.3mm type E3250 resistive load 16A | | |

solid state relays

CROUZET



1

| | | | |
|--------------------|--|-----------------|--------|
| Part No. | 403534 | Ref. No. | 203668 |
| description | solid state relay CROUZET 1 phase 100A 48-660V 4-32VDC L 58mm W 49mm new edition screw type 84137140 | | |



1

| | | | |
|--------------------|---|-----------------|--------|
| Part No. | 403535 | Ref. No. | 203669 |
| description | solid state relay CROUZET 1 phase 10A 24-280V 90-280VAC L 58mm W 49mm new edition screw type 84137001 | | |

heat-conducting foils



1

| | | | |
|--------------------|------------------------------------|-----------------|--------|
| Part No. | 401676 | Ref. No. | 203671 |
| description | heat-conducting foil L 57mm W 45mm | | |

relays

power relays

with special fixing



1

| | | | |
|--------------------|--|-----------------|--------|
| Part No. | 380441 | Ref. No. | 202732 |
| description | power relays SCHRACK 230VAC 16A 2NO connection coded plug manuf. no. 0419 110301 00 2-pole | | |

miscellaneous



1

| | | | |
|--------------------|---|-----------------|--------|
| Part No. | 381465 | Ref. No. | 203735 |
| description | remote control module 440V capacity 47nF 3x2M0hm DIN rail | | |

transformers

open transformers

with clamp terminal



1

| | | | |
|--------------------|--|-----------------|--------|
| Part No. | 403900 | Ref. No. | 202604 |
| description | control transformer primary 208-600VAC secondary 2x115VAC 460VA secondary 2A H 133mm L 150mm W 112mm 50/60Hz type EI 150N/49/F | | |

1

| | | | |
|--------------------|---|-----------------|-------------------------|
| Part No. | 403303 | Ref. No. | 202608 202608+202725 |
| description | transformer primary 110-250VAC secondary 230VAC 100VA connection plug 50/60Hz | | |



1

| | | | |
|--------------------|--|-----------------|--------|
| Part No. | 400791 | Ref. No. | 203999 |
| description | transformer primary 120/200/220/230V secondary 24V 108VA 50/60Hz | | |



1

| | | | |
|--------------------|---|-----------------|--------|
| Part No. | 400792 | Ref. No. | 203818 |
| description | transformer primary 200/208/220/230/240/250V secondary 4.2/10.7/21V 162VA 50/60Hz | | |



1

| | | | |
|--------------------|--|-----------------|------------------|
| Part No. | 403304 | Ref. No. | 203980 203981 |
| description | transformer primary 440VAC secondary 230VAC 500VA connection screw clamp 50/60Hz | | |

for lighting



1

| | | | |
|--------------------|--|-----------------|--------|
| Part No. | 403306 | Ref. No. | 203749 |
| description | transformer primary 230VAC secondary 11.5VAC 50VA secondary 4A connection screw L 165mm W 45mm H 37mm 50/60Hz mounting distance 155mm for lighting | | |

probes

producer-specific probes

probes



1

| | | | |
|--------------------|---|-----------------|--------|
| Part No. | 378120 | Ref. No. | 203991 |
| description | temperature probe thermocouple K (NiCr-Ni) cable PTFE probe -50 up to 1150°C cable -40 up to +250°C connection 2-wire thread M8x1 probe ø1.5x18mm cable length 1.6m | | |



1

| | | | |
|--------------------|---|-----------------|--------|
| Part No. | 378121 | Ref. No. | 203689 |
| description | temperature probe thermocouple K (NiCr-Ni) cable PTFE probe -50 up to 1150°C cable -40 up to +250°C connection 2-wire thread M8x1 probe ø1.5x18mm cable length 3.2m | | |



1

| | | | |
|--------------------|--|-----------------|--------|
| Part No. | 378122 | Ref. No. | 203693 |
| description | temperature probe thermocouple K (NiCr-Ni) cable silicone probe -50 up to 1150°C cable -50 up to +180°C connection 2-wire thread M10x1 probe ø3.5x13mm cable length 1.5m | | |



1

| | | | |
|--------------------|--|-----------------|--------|
| Part No. | 378123 | Ref. No. | 203990 |
| description | temperature probe thermocouple K (NiCr-Ni) cable silicone probe -50 up to 1150°C cable -50 up to +180°C connection 2-wire thread M10x1 probe ø3.5x13mm cable length 2.3m | | |

core probes



1

| | | | |
|--------------------|--|-----------------|--------|
| Part No. | 378537 | Ref. No. | 202738 |
| description | core temperature probe multipoint probe cable PTFE probe -40 up to +250°C cable -40 up to +250°C connection 5-wire probe ø4x100mm thread 1/4" cable length 1.8m handle ø 11mm handle length 75mm | | |



1

| | | | |
|--------------------|--|-----------------|--------|
| Part No. | 378124 ¹ | Ref. No. | 203697 |
| description | core temperature probe thermocouple K (NiCr-Ni) cable PTFE probe -40 up to +250°C cable -40 up to +250°C connection 5-wire probe ø4x100mm thread 1/4" cable length 1.5m handle ø 12mm handle length 90mm | | |

¹multipoint probe



| | | | |
|--|--|-----------------|--------|
|  | | | |
| Part No. | 378125 ¹ | Ref. No. | 203688 |
| description | core temperature probe thermocouple K (NiCr-Ni) cable PTFE probe -40 up to +250°C cable -40 up to +250°C connection 5-wire probe ø4x100mm thread 1/4" cable length 1.9m handle ø 12mm handle length 90mm | | |

¹multipoint probe

accessories

fasteners

| | | | |
|--|------------|-----------------|--------|
|  | | | |
| Part No. | 551022 | Ref. No. | 208032 |
| description | probe clip | | |

electronics

electronics accessories

| | | | |
|---|------------------------------------|-----------------|--------|
|  | | | |
| Part No. | 694973 | Ref. No. | 207097 |
| description | button for display PCB ø 15mm grey | | |

| | | | |
|--|---|-----------------|--------|
|  | | | |
| Part No. | 348214 | Ref. No. | 207186 |
| description | button for display PCB transparent suitable for MKN ED ø 16mm H 4.8mm for combi-steamer | | |

frequency converters

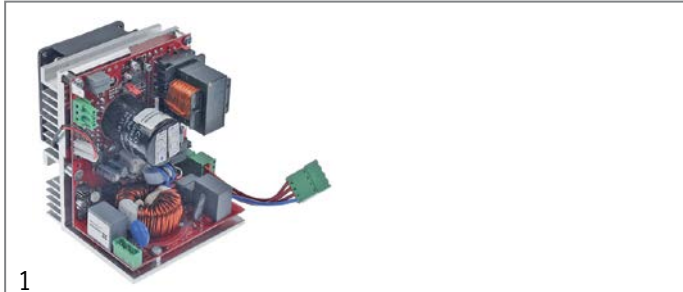
| | | | |
|--|--|-----------------|--------------------|
|  | | | |
| Part No. | 403214 | Ref. No. | 10012693 203784 |
| description | frequency converter with fan tray for hot air motors 100-240V L 135mm W 110mm H 135mm output frequency 0-100Hz input frequency 47-63Hz | | |

rectifiers

| | | | |
|--|--------------------|-----------------|--------|
|  | | | |
| Part No. | 400851 | Ref. No. | 203442 |
| description | rectifier 420V 10A | | |

PCBs

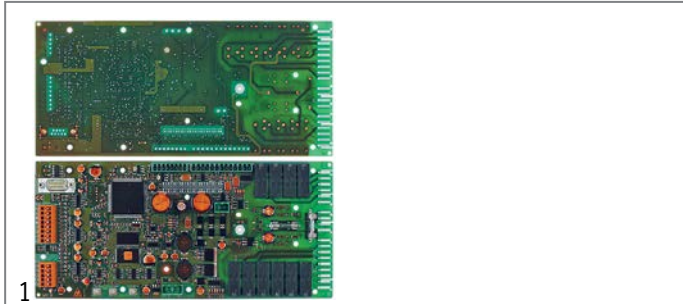
| | | | |
|--|--|-----------------|--------|
|  | | | |
| Part No. | 403807 | Ref. No. | 202676 |
| description | control PCB combi-steamer Hans Dampf L 250mm W 115mm | | |

| | | | |
|--|--|-----------------|--------|
|  | | | |
| Part No. | 403808 | Ref. No. | 202788 |
| description | controller for USB MKN L 64.5mm W 31.5mm | | |

1

| | | | |
|--------------------|------------|-----------------|--------|
| Part No. | 403034 | Ref. No. | 203746 |
| description | keypad PCB | | |



1

| | | | |
|--------------------|--------|-----------------|--------|
| Part No. | 401969 | Ref. No. | 203766 |
| description | PCB | | |



1

| | | | |
|--------------------|-------------------------------------|-----------------|--------|
| Part No. | 401697 | Ref. No. | 202690 |
| description | keypad PCB combi-steamer Hans Dampf | | |

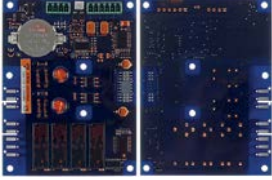

1

| | | | |
|--------------------|---|-----------------|--------|
| Part No. | 403806 | Ref. No. | 202698 |
| description | PCB combi-steamer Hans Dampf L 115mm W 87mm | | |



1

| | | | |
|--------------------|-------------------------------------|-----------------|--------|
| Part No. | 401698 | Ref. No. | 203745 |
| description | keypad PCB combi-steamer Hans Dampf | | |

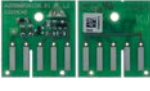

1

| | | | |
|--------------------|---|-----------------|--------|
| Part No. | 403809 | Ref. No. | 202600 |
| description | PCB for combi-steamer Hans Dampf L 28mm W 27mm for ignition electrode | | |



1

| | | | |
|--------------------|-------------------------------------|-----------------|--------|
| Part No. | 403869 | Ref. No. | 203773 |
| description | PCB for combi-steamer L 50mm W 50mm | | |

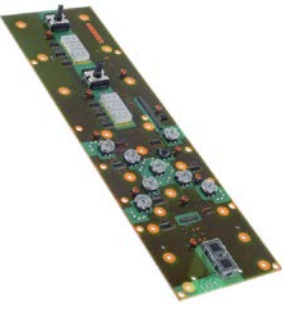

1

| | | | |
|--------------------|--|-----------------|--------|
| Part No. | 403307 | Ref. No. | 202128 |
| description | keypad PCB combi-steamer JUNIOR L 410mm W 115mm buttons 10 | | |

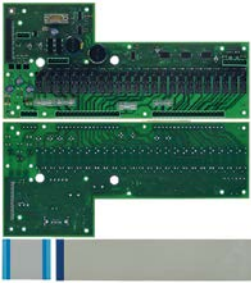

1

| | | | |
|--------------------|---|-----------------|--------|
| Part No. | 403872 | Ref. No. | 203747 |
| description | relay PCB for combi-steamer L 320mm W 150mm | | |



solenoid valves

solenoid valves (water)

INTERELEKTRIK

medium temperature: 90°C 90°C 60°C
 ambient temperature: 60°C 25°C 60°C
 duty cycle: 40% 100% 100%

with reducers



| | | | |
|--------------------|---|-----------------|--------|
| Part No. | 370843 | Ref. No. | 203663 |
| description | solenoid valve single straight 220-240 inlet 3/4" outlet 1/2" input 2l/min DN8 t.max. 90°C duty cycle 100% INTERELEKTRIK plastic flow regulating valve inlet yellow total length 84.5mm | | |



| | | | |
|--------------------|--|-----------------|--------|
| Part No. | 370144 | Ref. No. | 201160 |
| description | solenoid valve single straight 230VAC outlet 10.5mm t.max. 90°C plastic inlet 3/4"mm | | |

MÜLLER

medium temperature: 90°C
 duty cycle: 100%

spare parts and accessories

miscellaneous



| | | | |
|--------------------|---|-----------------|----------|
| Part No. | 371002 | Ref. No. | 10011599 |
| description | solenoid valve holder MÜLLER flange support | | |

various



| | | | |
|--------------------|------------------|-----------------|--------|
| Part No. | 370307 | Ref. No. | 203831 |
| description | valve unit 24VDC | | |

SOLENOID VALVES/PRESSURE SWITCHES MKN



| | | | |
|--------------------|------------------|-----------------|--------|
| Part No. | 370308 | Ref. No. | 203832 |
| description | valve unit 24VDC | | |

metal

PARKER

solenoid valves (various)



| | | | |
|--------------------|---|-----------------|--------|
| Part No. | 370749 | Ref. No. | 201153 |
| description | solenoid valve 2-ways 230VAC inlet 1/8" outlet 1/8" connection 1/8" L 30mm PARKER type series WB4.5 membranes Viton p max 10bar 50/60Hz brass | | |

Solenoid valve - accessories



| | | | |
|--------------------|-----------------------|-----------------|--------|
| Part No. | 371001 | Ref. No. | 204532 |
| description | solenoid valve holder | | |



| | | | |
|--------------------|---|-----------------|----------|
| Part No. | 371002 | Ref. No. | 10011599 |
| description | solenoid valve holder MÜLLER flange support | | |

pressure switches

for combi-steamers



| | | | |
|--------------------|--|-----------------|--------|
| Part No. | 543037 | Ref. No. | 202601 |
| description | pressure control ø 23mm pressure range 15/25mbar connection 9mm 42V 2A | | |



electrodes

| | | | |
|---|--|-----------------|--------|
| 1  | | | |
| Part No. | 401458 | Ref. No. | 203601 |
| description | level electrode M10x1 total length 132mm probe L 112mm insulated probe length 105mm connection F6.3 1/8" | | |
| For models: | 2022802B04, 2022802B05, 2022804B04, 2022804B05, 2022805B04, 2022805B05, 2022807B03, 2022807B04, 2022902-00, 2022902-01, 2022903-00, 2022903-01, 2023003B01, 2023003B02, 2023007B01, 2023007B02, 2023009B01, 2023009B02, 2062804B08 | | |

flow meters and flow sensors

flow meters

GICAR

| | | | |
|---|---|-----------------|--------|
| 1  | | | |
| Part No. | 403873 | Ref. No. | 203687 |
| description | flow meter thread M10x1 plastic nominal-ø 2mm approval NSF Qmax. 2.3l/min | | |

fans

axial fans

ebm-papst

| | | | |
|---|---|-----------------|--------|
| 1  | | | |
| Part No. | 601715 ¹ | Ref. No. | 203819 |
| description | axial fan L 119mm W 119mm H 38mm 230VAC 50Hz 18W bearing ball bearing manuf. no. 4656ZW metal connection cable 310mm ebm-papst fan wheel ø 110mm temp.-resist. 75°C | | |

¹with ball bearings

hot air motors

| | | | |
|--|--|-----------------|--------|
| 1  | | | |
| Part No. | 601862 | Ref. No. | 203977 |
| description | fan motor 200-230V 3 phase 50Hz 0.45/0.65kW 700/1400rpm speeds 2 L1 145mm L2 35mm L3 35mm 0.7/2A D1 ø 17mm D2 ø 13.5mm | | |

| | | | |
|--|--|-----------------|--------|
| 1  | | | |
| Part No. | 501583 | Ref. No. | 202745 |
| description | fan motor 200-240V 50/60Hz 3000/3600rpm L1 125mm L2 35mm L3 15mm ø 100mm 0.5/0,7A type L5tw2 - 695 D1 ø 8mm D2 ø 8x7.5mm | | |

| | | | |
|--|--|-----------------|--------|
| 1  | | | |
| Part No. | 602153 | Ref. No. | 202673 |
| description | fan motor 200-480V 3 phase 50/60Hz 0.6-0.82kW 1380/1650rpm speeds 1 L1 151mm L2 67mm L3 35mm ø 160mm M10 IT 2.8/1.6A at 50Hz 200-415V at 60Hz 200-480V at 50Hz 1380rpm at 60Hz 1650rpm type L9Fw4D-678 no. C6 D1 ø 17mm D2 ø 13.5mm with shaft sealing | | |

| | | | |
|--|--|-----------------|--------|
| 1  | | | |
| Part No. | 601485 | Ref. No. | 203771 |
| description | fan motor 240V 3 phase 60Hz 0.68kW 1730rpm speeds 1 L1 150mm L2 24mm L3 35mm M10R IT 2.9A power input 870W at 60Hz 1730rpm type L9DFw4D-596 no. W6 D1 ø 17mm D2 ø 13mm | | |



1

| | | | |
|--------------------|--|-----------------|--------|
| Part No. | 514511 | Ref. No. | 062005 |
| description | fan wheel blades 12 D1 ø 280mm D2 ø 13mm D3 ø 16mm H1 110mm H2 31mm H3 4.5mm | | |



1

| | | | |
|--------------------|--|-----------------|--------|
| Part No. | 514512 | Ref. No. | 062002 |
| description | fan wheel blades 12 D1 ø 350mm D2 ø 13mm D3 ø 16mm H1 115mm H2 32mm H3 4.5mm | | |



1

| | | | |
|--------------------|--------------------------------------|-----------------|--------|
| Part No. | 699359 | Ref. No. | 945446 |
| description | flange ED ø 60mm int. ø 1 22mm SS M4 | | |



1

| | | | |
|--------------------|---|-----------------|--------|
| Part No. | 699364 | Ref. No. | 204681 |
| description | flange for combi-steamer ED ø 50mm int. ø 1 24mm int. ø 2 19mm thickness 7mm SS | | |



1

| | | | |
|--------------------|---|-----------------|--------|
| Part No. | 699363 | Ref. No. | 204423 |
| description | flange for combi-steamer ED ø 57mm int. ø 1 24mm int. ø 2 19mm thickness 7mm SS | | |



1

| | | | |
|--------------------|---|-----------------|--------|
| Part No. | 699360 | Ref. No. | 945661 |
| description | flange for combi-steamer int. ø 1 22mm int. ø 2 8.5mm thickness 4mm SS L 53mm W 50mm M4 | | |

radial fans



1

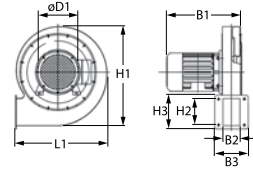

| | | | |
|--------------------|--|-----------------|--------|
| Part No. | 601181 | Ref. No. | 203994 |
| description | radial fan 230V voltage AC 50/60Hz 100W H1 170mm L1 175mm D1 ø 50mm W1 115mm W2 40mm H2 45mm | | |

miscellaneous



1

| | | | |
|--------------------|--|-----------------|--------|
| Part No. | 601475 | Ref. No. | 203926 |
| description | radial fan 230V voltage AC 50/60Hz 20W H1 180mm L1 180mm D1 ø 86mm W1 40mm W2 34mm H2 122mm W3 40mm H3 172mm | | |

pumps

drain pumps

HANNING



1

| | | | |
|--------------------|--|-----------------|--------|
| Part No. | 499302 | Ref. No. | 203788 |
| description | drain pump inlet ø 24mm outlet ø 24mm 220-240V 30W 50Hz HANNING type DPS25-303 | | |



magnetic-drive pumps



1

| | | | |
|--------------------|---|-----------------|--------|
| Part No. | 500696 | Ref. No. | 203825 |
| description | magnetic-drive pump HANNING type DP040-025 30W 230V 50Hz inlet ø 24mm outlet ø 11mm L 130mm | | |



1

| | | | |
|--------------------|---|-----------------|--------|
| Part No. | 499303 | Ref. No. | 203826 |
| description | magnetic-drive pump HANNING type DP040-028 65W 208-240V 60Hz inlet ø 24mm outlet ø 11mm L 140mm | | |

condensators & interference suppression filters

operating capacitors

plastic



1

| | | | |
|--------------------|---|-----------------|--------|
| Part No. | 365031 | Ref. No. | 202742 |
| description | operating capacitor capacity 4µF 450V tolerance 5% 50/60Hz ambient temperature max. -25 to +85°C ø 31mm L 58mm M8 plastic connection male faston 6.3mm protection | | |

filters

RC circuits



1

| | | | |
|--------------------|--|-----------------|--------|
| Part No. | 381485 | Ref. No. | 203743 |
| description | RC circuit type LA4DA2U 110-240V Qty 1 pcs | | |



1

| | | | |
|--------------------|----------------------------------|-----------------|--------|
| Part No. | 380049 | Ref. No. | 203683 |
| description | RC circuit type LAD4RCU 110-250V | | |

fuses

fine fuses



1

| | | | |
|--------------------|--|-----------------|--------|
| Part No. | 358601 | Ref. No. | 203722 |
| description | fine fuse size ø5x20mm 1.25A slow-acting rated 250V Qty 10 pcs | | |



1

| | | | |
|--------------------|--|-----------------|--------|
| Part No. | 358608 | Ref. No. | 203996 |
| description | fine fuse size ø5x20mm 10A slow-acting rated 250V Qty 10 pcs | | |



1

| | | | |
|--------------------|---|-----------------|--------|
| Part No. | 358607 | Ref. No. | 203473 |
| description | fine fuse size ø5x20mm 6.3A slow-acting rated 250V Qty 10 pcs | | |

fine fuse holders



1

| | | | |
|--------------------|--|-----------------|--------|
| Part No. | 551378 | Ref. No. | 203635 |
| description | fuse holder for USIG suitable fuse 5x20/5x25/5x30 1-pole 6.3A rated 400V L 45.4mm W 9.9mm H 32mm connection plug-in connection Phoenix Control ST-SI | | |

screw locks

D0-system (NEOZED)



1

| | | | |
|--------------------|---|-----------------|--------|
| Part No. | 358045 | Ref. No. | 203739 |
| description | fuse size D02 35A rated 250/400V E18 ø 15mm L 36mm Qty 10 pcs | | |



electric accessories

cables

connection cables

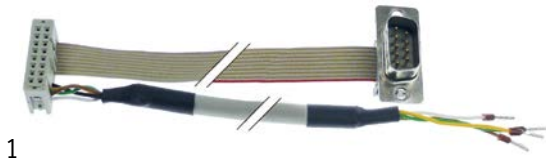

| | | | |
|--------------------|---|-----------------|--------|
| 1 | | | |
| Part No. | 579003 | Ref. No. | 033057 |
| description | connection cable L 1030mm 13-pole for USB | | |

terminals and connectors

not insulated

female fastons

iron nickel-plated



| | | | |
|--------------------|---|-----------------|--------|
| 1 | | | |
| Part No. | 550001 | Ref. No. | 203089 |
| description | female faston size 6.3x0.8mm 1.0-2.5mm ² straight Fe gal Ni t.max. 340°C Qty 100 pcs | | |

plug connectors



| | | | |
|--------------------|--|-----------------|--------|
| 1 | | | |
| Part No. | 551354 | Ref. No. | 202689 |
| description | plug connector 50-pole raster size 2mm | | |

terminals

PCB terminal blocks



| | | | |
|--------------------|--|-----------------|--------|
| 1 | | | |
| Part No. | 551355 | Ref. No. | 203690 |
| description | PCB terminal block 5-pole raster size 3.8mm cross section 1.5mm ² | | |

rail-mounted terminals

WIELAND

accessories



| | | | |
|--------------------|--|-----------------|--------|
| 1 | | | |
| Part No. | 550370 | Ref. No. | 203273 |
| description | terminal block end bracket clampsmm ² | | |

miscellaneous



| | | | |
|--------------------|--|-----------------|--------|
| 1 | | | |
| Part No. | 551377 | Ref. No. | 203634 |
| description | fuse holder Phönix Control type USIG 0.5-16mm ² DIN rail black W 10.2mm L 61mm for fuse holder 10A rated 500V | | |



| | | | |
|--------------------|---|-----------------|--------|
| 1 | | | |
| Part No. | 551356 | Ref. No. | 203271 |
| description | rail-mounted terminal Phönix Control type UK10 6-10mm ² W 8mm L 43mm max. 50A max 500V | | |



| | | | |
|--------------------|---|-----------------|--------|
| 1 | | | |
| Part No. | 551373 | Ref. No. | 203620 |
| description | rail-mounted terminal Phönix Control type UK16 0.5-16mm ² top-hat rail 35mm grey W 10.2mm L 42.5mm | | |



| | | | |
|--------------------|---|-----------------|--------|
| 1 | | | |
| Part No. | 551375 | Ref. No. | 203622 |
| description | rail-mounted terminal Phönix Control type UK35 0.75-35mm ² DIN rail grey W 15.1mm L 62mm | | |

1

| | | | |
|--------------------|---|-----------------|--------|
| Part No. | 551371 | Ref. No. | 203279 |
| description | rail-mounted terminal Phoenix Control type USLKG10 0.5-10mm ² yellow/green for DIN rail 35mm H 45mm 1-pole | | |



1

| | | | |
|--------------------|---|-----------------|--------|
| Part No. | 551374 | Ref. No. | 203621 |
| description | rail-mounted terminal Phoenix Control type USLKG16 0.5-16mm ² yellow/green W 10.2mm L 42.5mm for DIN rail 35mm H 45mm 1-pole | | |



1

| | | | |
|--------------------|---|-----------------|--------|
| Part No. | 551376 | Ref. No. | 203633 |
| description | rail-mounted terminal Phoenix Control type USLKG35 0.75-35mm ² DIN rail yellow/green W 15mm L 50mm for DIN rail 35mm H 62mm 1-pole | | |

electronic magnets



1

| | | | |
|--------------------|--------------------------------|-----------------|--------|
| Part No. | 400793 | Ref. No. | 203672 |
| description | lifting magnet 205V voltage DC | | |



gas valves and ignition boxes

gas control valves

HONEYWELL



1

| | | | | |
|---|--|-----------------|-----------------|---|
| Part No. | 106012 | Ref. No. | 201181 | |
| description | gas valve type VK4115V 220-240V 50/60Hz gas inlet flange 32x32mm gas outlet flange 32x32mm thermocouple connection pilot connection pressure range 15-60mbar max 60mbar operator type HONEYWELL flange 32x32mm | | | |
| accessories for | 106012 | | | |
|  | Part No. | 102845 | Ref. No. | — |
| | gas connection angled 1/2" flange 32x32mm hole distance 24x24mm Tandem | | | |
|  | Part No. | 102846 | Ref. No. | — |
| | gas connection straight 1/2" flange 32x32mm hole distance 24x24mm suitable for Tandem | | | |

ignition boxes

DUNGS



1

| | | | |
|--------------------|---|-----------------|--------------------------------------|
| Part No. | 102378 | Ref. No. | 201643 201662 201699 201735 |
| description | ignition box type DGAI.73 model 10.1.0TCL electrodes 2 starting time <10s waiting time >3s safety time <1s 230V 50/60Hz ignition cable male faston 2.8mm DUNGS protection IP20 DGAI.73 | | |
| For models: | 2061401-05, 2061401-06, 2061402-05, 2061402-06, 2061403-0, 2061403-00, 2061403-02, 2061403-03, 2061403-04, 2061404-0, 2061404-00, 2061404-02, 2061404-03, 2061404-04, 2061405-01, 2061405-02, 2061405-03, 2061406-01, 2061406-02, 2061406-03, 2062801-06, 2062801A06, 2062801B06, 2062801C06, 2062802-06, 2062802A00, 2062802B06, 2062802B07, 2062802B08, 2062802C06, 2062803-06, 2062803A06, 2062803C06, 2062804-06, 2062804A06, 2062804B06, 2062804B07, 2062804B08, 2062804C06, 3061403-01, 3061403-02, 3061403-03, 3061404-01, 3061404-02, 3061404-03, 3061405-01, 3061405-02, 3061405-03, 3061406-01, 3061406-02... (Other models you can see in the webshop) | | |



HONEYWELL



1

| | | | |
|--------------------|------------------------|-----------------|--------|
| Part No. | 106607 | Ref. No. | 201180 |
| description | cover for ignition box | | |



1

| | | | |
|--------------------|--|-----------------|--------|
| Part No. | 106606 | Ref. No. | 201179 |
| description | ignition box HONEYWELL type S4575B 1025 electrodes 3 waiting times safety time 5s 230-240V 4VA 50/60Hz | | |

ignition parts

pilot burners



JUNKERS













CB 502 series

pilot burners



1

| | | | |
|---|--|-----------------|--|
| Part No. | 102843 | Ref. No. | 520917 520997 |
| description | pilot burner JUNKERS type CB502031 natural gas nozzle no.6 gas pressure 25mbar gas connection 6mm with primary air | | |
| For models: | 2060301-00, 2062801-00, 2062801A00, 2062801B00, 2062801C00, 2062802-0, 2062802-00, 2062802-2, 2062802A00, 2062802B00, 2062802C00, 2062803-0, 2062803-00, 2062803-2, 2062803A00, 2062803C00, 2062804-0, 2062804-2, 2062804A00, 2062804B00, 2062804C00, 2062901-0, 2062901-00, 2062901-2, 2062901A00, 2062901B00, 2062901B01, 2062901B02, 2062901C00, 2062901C01, 2062901C02, 2062902-0, 2062902-00, 2062902-2, 2062902A00, 2062902B00, 2062902B01, 2062902B02, 2062902C00, 2062902C01, 2062902C02 | | |
| spare parts for | 102843 | | |
|  | Part No. | 100227 | Ref. No. — |
| | pilot burner nozzle natural gas gas pressure 25mbar code 6 Qty 1 pcs suitable for JUNKERS CB50203_ | | |
|  | Part No. | 100704 | Ref. No. 201570 201572 201578 |
| | ignition electrode D1 ø 9mm connection M4 D2 ø 11mm L1 17mm L2 17mm BL1 13mm BL2 4mm BL3 22mm | | |

| | | | |
|---|---|--------|------------------------|
| spare parts for | 102843 | | |
|  | Part No. | 100909 | Ref. No. — |
| | union screw thread M10x1 for pipe ø 6mm Qty 1 pcs | | |
|  | Part No. | 101287 | Ref. No. — |
| | olive for pipe ø 6mm Qty 1 pcs | | |
|  | Part No. | 101292 | Ref. No. — |
| | union screw for igniter suitable for CB 502/505 Qty 1 pcs | | |
| accessories for | 102843 | | |
|  | Part No. | 100220 | Ref. No. 201547 |
| | pilot burner nozzle LPG gas pressure 50mbar code 2 Qty 1 pcs suitable for JUNKERS CB503_ | | |
|  | Part No. | 100221 | Ref. No. — |
| | pilot burner nozzle LPG gas pressure 30mbar code 29 Qty 1 pcs suitable for JUNKERS CB50203_ | | |
|  | Part No. | 100222 | Ref. No. 201641 |
| | pilot burner nozzle LPG gas pressure 50mbar code 5 Qty 1 pcs suitable for JUNKERS CB50203_ | | |
|  | Part No. | 100223 | Ref. No. — |
| | pilot burner nozzle natural gas gas pressure 20mbar code 3 Qty 1 pcs suitable for JUNKERS CB503_ | | |
|  | Part No. | 100224 | Ref. No. — |
| | pilot burner nozzle natural gas gas pressure 25mbar code 26 Qty 1 pcs suitable for JUNKERS CB503_ | | |
|  | Part No. | 100225 | Ref. No. — |
| | pilot burner nozzle LPG gas pressure 30mbar code 39 Qty 1 pcs suitable for JUNKERS CB503_ | | |
|  | Part No. | 100226 | Ref. No. — |
| | pilot burner nozzle LPG gas pressure 50mbar code 15 suitable for JUNKERS | | |
|  | Part No. | 100228 | Ref. No. — |
| | pilot burner nozzle town gas gas pressure 8mbar code 4 Qty 1 pcs suitable for JUNKERS CB50203_ | | |
|  | Part No. | 101281 | Ref. No. 201560 |
| | olive for pipe ø 4mm L 8.7mm Qty 1 pcs suitable for CB 502/503 | | |
|  | Part No. | 101283 | Ref. No. 201692 |
| | union screw thread M10x1 for pipe ø 4mm Qty 1 pcs | | |



electrodes



| | | | |
|------------------------|---|-----------------|------------------------------------|
| Part No. | 102289 | Ref. No. | 201176 201176+ 211137+ 2x211143 |
| description | glow plug mounting distance 28mm cable length 600mm connection male faston 2.8mm | | |
| spare parts for | 102289 | | |
| |  | Part No. | 691609 |
| | | Ref. No. | 211143 |
| description | gasket graphite ED ø 150mm ID ø 115mm thickness 2mm Qty 1 pcs | | |

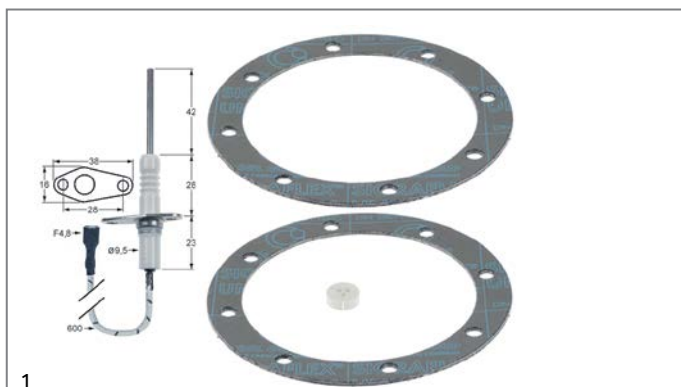

| | | | |
|--------------------|--|-----------------|--------|
| Part No. | 102290 | Ref. No. | 201177 |
| description | monitoring electrode flange length 38mm D1 ø 9.5mm flange width 16mm L1 42mm BL1 28mm BL2 23mm connection F4.8x0.8 cable length 600mm fixing dimensions 28mm | | |

thermocouples

plug-in thermocouples

plug-in thermocouples standard

with barrel socket ø6mm

SIT

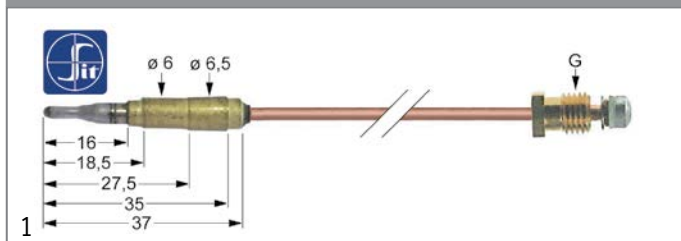

| | | | |
|--------------------|--|-----------------|--------|
| Part No. | 102267 | Ref. No. | 201670 |
| description | thermocouple M8x1 L 850mm plug connection ø6.0mm | | |
| For models: | 2061101-01, 2061101-02, 2061102-01, 2061107-00, 2061107-01, 3061101-00, 3061101-01, 3061102-00, 3061107-00, 3061107-01 | | |

threaded thermocouples

threaded thermocouples standard

with socket with thread M8x1

SIT

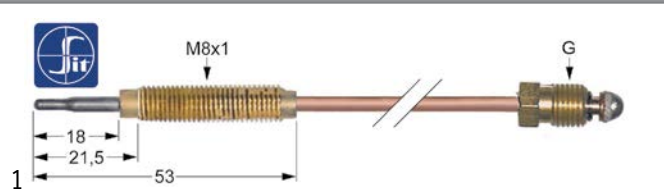

| | | | |
|--------------------|---|-----------------|----------------------------|
| Part No. | 107632 | Ref. No. | 201352 201532 201539 |
| description | thermocouple SIT M8x1 L 1000mm M8x1 | | |
| For models: | 2061101-0, 2061102-0, 2061103-0, 2061104-0, 2061104-00, 2061105-0, 2061105-00, 2061106-0, 2061106-00, 2062901B02, 2062901C02, 2062902B02, 2062902C02, 2063401-0, 2063401-00, 2063401-01, 2063401-02, 2063401-03, 2063401-04, 2063402-0, 2063402-00, 2063402-01, 2063402-02, 2063402-03, 2063402-04, 2063403-00, 2063403-01, 2063403-02, 2063403-03, 2063403-04, 2063403-05, 2063403-06, 2063403-07, 2063403-08, 2063404-00, 2063404-01, 2063404-02, 2063404-03, 2063404-04, 2063404-05, 2063405-0, 2063405-00, 2063405-01, 2063405-02, 2063405-03, 2063405-04, 2063406-00, 2063406-01, 2063406-02, 2063406-03...(Other models you can see in the webshop) | | |

accessories

interrupters



| | | | |
|--------------------|---|-----------------|------------------|
| Part No. | 101258 | Ref. No. | 201478 203478 |
| description | interrupter thread M10x1 | | |
| For models: | 2060301-00, 2060301-01, 2062802-0, 2062802-1, 2062802-2, 2062803-0, 2062803-1, 2062803-2, 2062804-0, 2062804-1, 2062804-2, 2062901-0, 2062901-1, 2062901-2, 2062902-0, 2062902-1, 2062902-2 | | |

gas burners

forced air burners

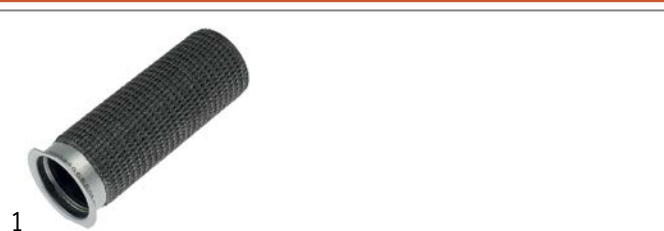

| | | | |
|--------------------|--|-----------------|--------|
| Part No. | 107842 | Ref. No. | 201178 |
| description | burner L 150mm ø 50mm 20kW combi-steamer | | |



1

| | | | |
|--------------------|---|-----------------|--------|
| Part No. | 107877 | Ref. No. | 201174 |
| description | connecting fitting for burner MKN combi-steamer | | |



1

| | | | |
|--------------------|---|-----------------|--------|
| Part No. | 107878 | Ref. No. | 201172 |
| description | connecting fitting for burner MKN combi-steamer | | |



1

| | | | |
|--------------------|---------------------------------------|-----------------|--------|
| Part No. | 108150 | Ref. No. | 201182 |
| description | venturi MKN combi-steamer with gasket | | |

equipment-specific units

for convection ovens/combi-steamers

drain units

drip rails



1

| | | | |
|--------------------|--|-----------------|--------|
| Part No. | 692765 | Ref. No. | 202125 |
| description | drip rail L 620mm plastic with support plate W 38mm hole ø 5mm for combi-steamer | | |

spare parts and accessories



1

| | | | |
|--------------------|---|-----------------|--------|
| Part No. | 699338 | Ref. No. | 202726 |
| description | battery Lithium H 8mm ø 24.5mm 3V CR2477N | | |

housing and bezels



1

| | | | |
|--------------------|-------------------------------|-----------------|--------|
| Part No. | 694972 | Ref. No. | 866789 |
| description | bracket L 52mm W 28mm H 115mm | | |



1

| | | | |
|--------------------|---------------------------------|-----------------|--------|
| Part No. | 699337 | Ref. No. | 202782 |
| description | cover cap for USB L 38mm W 29mm | | |

cleaning system

nozzles



1

| | | | |
|--------------------|--|-----------------|--------|
| Part No. | 694665 | Ref. No. | 201146 |
| description | nozzle thread 1/4" ET H 57mm for cleaning system | | |



1

| | | | |
|--------------------|--|-----------------|--------|
| Part No. | 694664 | Ref. No. | 201152 |
| description | nozzle thread 1/4" ET WS 17 H 37mm for cleaning system | | |

screw connections



1

| | | | |
|--------------------|---|-----------------|--------|
| Part No. | 362008 | Ref. No. | 205293 |
| description | connecting piece 1/2" -3/4" L 100.5mm plastic | | |

drip water trays



1

| | | | |
|--------------------|---|-----------------|--------|
| Part No. | 692725 | Ref. No. | 202138 |
| description | gutter for model 10.x L 605mm W 50mm H 20mm plastic | | |



miscellaneous



| | | | |
|--------------------|---|-----------------|--------|
| 1 | | | |
| Part No. | 691608 | Ref. No. | 211137 |
| description | boiler gasket silicone ED ø 15mm suitable for MKN | | |



| | | | |
|--------------------|---|-----------------|--------|
| 1 | | | |
| Part No. | 694663 | Ref. No. | 203356 |
| description | duct bore ø 30mm D1 ø 33.5mm D2 ø 30mm plastic H 12mm | | |



| | | | |
|--------------------|----------------------------|-----------------|--------|
| 1 | | | |
| Part No. | 692813 | Ref. No. | 201135 |
| description | screen for drain D1 ø 90mm | | |

for tilting bratt pans

spindles



| | | | |
|--------------------|---|-----------------|--------|
| 1 | | | |
| Part No. | 514365 | Ref. No. | 110115 |
| description | threaded rod | | |
| For models: | 2021405-0, 2021405-00, 2021405-01, 2021405-02, 2021405-03, 2021405B00, 2021405B01, 2023003-0, 2023003-00, 2023003-1, 2023003A00, 2023003B00, 2023003C00, 2023005-0, 2023005-00, 2023005-1, 2023005A00, 2023005B00, 2023005C00, 2023007-0, 2023007-00, 2023007-1, 2023007A00, 2023007B00, 2023007C00, 2023009-0, 2023009-00, 2023009-1, 2023009A00, 2023009B00, 2023009C00, 3061403-00, 3061403-01, 3061403-02, 3061403-03, 3061403A00, 3061403B00, 3061403C00, 3061405-00, 3061405-01, 3061405-02, 3061405-03, 3061405B00 | | |

for boiling pans

gearboxes



| | | | |
|--------------------|---|-----------------|--------|
| 1 | | | |
| Part No. | 514365 | Ref. No. | 110115 |
| description | threaded rod | | |
| For models: | 2021405-0, 2021405-00, 2021405-01, 2021405-02, 2021405-03, 2021405B00, 2021405B01, 2023003-0, 2023003-00, 2023003-1, 2023003A00, 2023003B00, 2023003C00, 2023005-0, 2023005-00, 2023005-1, 2023005A00, 2023005B00, 2023005C00, 2023007-0, 2023007-00, 2023007-1, 2023007A00, 2023007B00, 2023007C00, 2023009-0, 2023009-00, 2023009-1, 2023009A00, 2023009B00, 2023009C00, 3061403-00, 3061403-01, 3061403-02, 3061403-03, 3061403A00, 3061403B00, 3061403C00, 3061405-00, 3061405-01, 3061405-02, 3061405-03, 3061405B00 | | |

knobs

producer-specific knobs

MKN



| | | | |
|--------------------|--|-----------------|--------|
| 1 | | | |
| Part No. | 112526 | Ref. No. | 209481 |
| description | knob potentiometer t.max. °C ø 71mm shaft ø 6x4.6mm shaft flat upper with spring | | |

1

| | | | |
|--------------------|--------|-----------------|--------|
| Part No. | 111951 | Ref. No. | 580030 |
| description | knob | | |

locks

electromagnetic closer



| | | | |
|--------------------|---|-----------------|--------|
| 1 | | | |
| Part No. | 692216 | Ref. No. | 203768 |
| description | electromagnetic closer 24V voltage DC L 104mm W 24mm H 34mm series 8440 | | |

handle latches

producer-specific

MKN



| | | | |
|--------------------|---|-----------------|--------|
| 1 | | | |
| Part No. | 691666 | Ref. No. | 207092 |
| description | catch clamp length 46mm BL 31mm for off-set 59-69mm | | |

| | | | |
|------------------------|-----------------|--------|-----------------|
| spare parts for | 691666 | | |
| | Part No. | 514390 | Ref. No. |
| | — | | |

| | | | |
|--|--|--|--|
| | spring for door handle ø 6mm L 54mm W 27.5mm | | |
|--|--|--|--|



| | | | |
|------------------------|-----------------|--------|-----------------|
| accessories for | 691666 | | |
| | Part No. | 691780 | Ref. No. |
| | 207090 | | |

| | | | |
|--|--|--|--|
| | door catch L 24mm H 21mm thread M8 thread L 20mm | | |
|--|--|--|--|

Table continues overleaf

3 mechanical components, equipment accessories



| | | | |
|---|---|--------|-------------------|
| accessories for | 691666 | | |
|  | Part No. | 694066 | Ref. No. — |
| | door catch with spigot 2-stage L 28mm W 14mm H 15mm H1 16mm total length 51mm thread M8 thread L 23mm stainless steel | | |
|  | Part No. | 694067 | Ref. No. — |
| | door catch with spigot 1-stage L 26mm total length 51mm thread M8 | | |

| | | | |
|---|--|-----------------|----------|
|  | 1 | | |
| Part No. | 692726 | Ref. No. | 10012036 |
| description | catch for combi-steamer mounting thread M4/M8 clamp length 48mm BL 45mm ø 42mm | | |



| | | | |
|---|---------------------------------|-----------------|--------|
|  | 1 | | |
| Part No. | 694660 | Ref. No. | 207094 |
| description | catch L 103mm clamp length 60mm | | |

| | | | |
|--|---|-----------------|--------|
|  | 1 | | |
| Part No. | 699292 | Ref. No. | 203737 |
| description | counterpart for door handle L 135mm W 35mm H 42mm hole ø 18mm | | |

| | | | |
|---|---|-----------------|--------|
|  | 1 | | |
| Part No. | 694662 | Ref. No. | 203667 |
| description | cover for door latch plastic grey L 185mm W 48mm mounting distance 186mm D 37mm | | |

| | | | |
|---|--|-----------------|--------|
|  | 1 | | |
| Part No. | 691780 | Ref. No. | 207090 |
| description | door catch L 24mm H 21mm thread M8 thread L 20mm | | |



| | | | |
|---|---|-----------------|--------|
|  | 1 | | |
| Part No. | 705011 | Ref. No. | 207103 |
| description | door catch L 57mm W 13mm mounting thread 6mm BL 6mm | | |

| | | | |
|--|--|-----------------|------------------------|
|  | 1 | | |
| Part No. | 691617 | Ref. No. | 207089 |
| description | door handle grey plastic | | |
| accessories for | 691617 | | |
|  | Part No. | 691666 | Ref. No. 207092 |
| | catch clamp length 46mm BL 31mm for off-set 59-69mm | | |
|  | Part No. | 691777 | Ref. No. 202662 |
| | cover cap plastic grey L 94mm W 40mm mounting distance 75mm D 36mm | | |
|  | Part No. | 691780 | Ref. No. 207090 |
| | door catch L 24mm H 21mm thread M8 thread L 20mm | | |
|  | Part No. | 691782 | Ref. No. 801064 |
| | cover plate round ø 40mm thickness 1mm | | |
|  | Part No. | 691783 | Ref. No. 801059 |
| | cover plate rectangular L 35mm W 14mm thickness 1mm | | |

| | | | |
|---|---|-----------------|--------|
|  | 1 | | |
| Part No. | 691785 | Ref. No. | 207147 |
| description | catch L 97mm clamp length 54mm BL 39mm ø 51.5mm | | |

| | | | |
|---|--|-----------------|--------|
|  | 1 | | |
| Part No. | 691786 | Ref. No. | 207148 |
| description | door catch L 38mm H 19mm thread M8 thread L 21mm | | |



| | | | |
|---|--|-----------------|------------------------|
|  | | | |
| 1 | | | |
| Part No. | 691784 | Ref. No. | 207149 |
| description | door handle L 200mm W 32mm H 70mm grey plastic | | |
| accessories for | 691784 | | |
|  | Part No. | 691777 | Ref. No. 202662 |
| | cover cap plastic grey L 94mm W 40mm mounting distance 75mm D 36mm | | |
|  | Part No. | 691781 | Ref. No. 802694 |
| | cover plate round ø 38mm thickness 1mm | | |
|  | Part No. | 691785 | Ref. No. 207147 |
| | catch L 97mm clamp length 54mm BL 39mm ø 51.5mm | | |
|  | Part No. | 691786 | Ref. No. 207148 |
| | door catch L 38mm H 19mm thread M8 thread L 21mm | | |

| | | | |
|--|--|-----------------|--------|
|  | | | |
| 1 | | | |
| Part No. | 691777 | Ref. No. | 202662 |
| description | cover cap plastic grey L 94mm W 40mm mounting distance 75mm D 36mm | | |

| | | | |
|---|---|-----------------|--------|
|  | | | |
| 1 | | | |
| Part No. | 691783 | Ref. No. | 801059 |
| description | cover plate rectangular L 35mm W 14mm thickness 1mm | | |

| | | | |
|---|--|-----------------|--------|
|  | | | |
| 1 | | | |
| Part No. | 691781 | Ref. No. | 802694 |
| description | cover plate round ø 38mm thickness 1mm | | |

| | | | |
|---|--|-----------------|--------|
|  | | | |
| 1 | | | |
| Part No. | 691782 | Ref. No. | 801064 |
| description | cover plate round ø 40mm thickness 1mm | | |

gaskets

gaskets for heated units

door seals

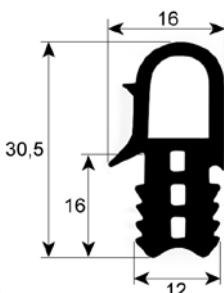
| | | | |
|--|---|-----------------|--------|
|  | | | |
| 1 | | | |
| Part No. | 901456 | Ref. No. | 211112 |
| description | door seal profile 2063 perimeter 1540mm Qty 1 | | |

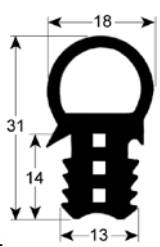
| | | | |
|---|--|-----------------|----------|
|  | | | |
| 1 | | | |
| Part No. | 902213 | Ref. No. | 10012490 |
| description | door seal profile 2064 W 600mm L 740mm outer plug size | | |

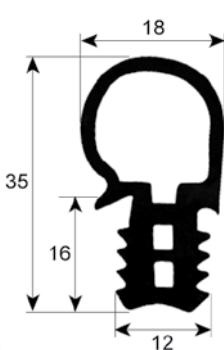
| | | | |
|--|---|-----------------|--------|
|  | | | |
| 1 | | | |
| Part No. | 900793 | Ref. No. | 211096 |
| description | door seal profile 2065 W 605mm L 1480mm external size Qty 1 | | |

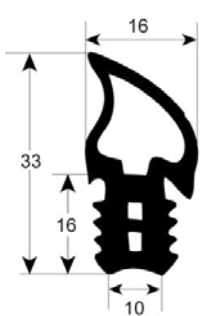
| | | | |
|--|--|-----------------|--------|
|  | | | |
| 1 | | | |
| Part No. | 900783 | Ref. No. | 211094 |
| description | door seal profile 2743 W 480mm L 610mm external size Qty 1 | | |



1

| | | | |
|--------------------|--|-----------------|--------|
| Part No. | 900784 | Ref. No. | 211095 |
| description | door seal profile 2743 W 610mm L 750mm external size Qty 1 | | |

gaskets for tray rack trolleys

1

| | | | |
|--------------------|---|-----------------|--------|
| Part No. | 901157 | Ref. No. | 211104 |
| description | tray rack trolley gasket profile 4075 L 645mm | | |

gaskets for control panels

1

| | | | |
|--------------------|--|-----------------|--------|
| Part No. | 902447 | Ref. No. | 211087 |
| description | gasket for cover L 1580mm suitable for MKN for combi-steamer with 6 mounting clips | | |

1

| | | | |
|--------------------|--|-----------------|--------|
| Part No. | 902448 | Ref. No. | 211088 |
| description | gasket for cover L 2040mm suitable for MKN for combi-steamer with 6 mounting clips | | |

O-rings

Viton

1

| | | | |
|--------------------|--|-----------------|--------|
| Part No. | 532733 | Ref. No. | 211086 |
| description | O-ring Viton thickness 5mm ID ø 65mm Qty 1 pcs | | |

sealing washers

graphite gaskets

1

| | | | |
|--------------------|---|-----------------|--------|
| Part No. | 691609 | Ref. No. | 211143 |
| description | gasket graphite ED ø 150mm ID ø 115mm thickness 2mm Qty 1 pcs | | |

copper gaskets

DIN-7603-C

1

| | | | |
|--------------------|--|-----------------|--------|
| Part No. | 528520 | Ref. No. | 211004 |
| description | gasket copper ED ø 22mm ID ø 16mm thickness 2mm | | |
| For models: | 2061101-01, 2061101-02, 2061102-01, 2061107-00, 2061107-01, 2061401-00, 2061401-04, 2061401-05, 2061401-06, 2061401A03, 2061401B03, 2061401C03, 2061402-04, 2061402-05, 2061402-06, 2061402A03, 2061402B03, 2061402C03, 2061403-02, 2061403-03, 2061403-04, 2061404-0, 2061404-00, 2061404-01, 2061404-02, 2061404-03, 2061404-04, 2061404A00, 2061404B00, 2061404C00, 2061405-01, 2061405-02, 2061405-03, 2061406-01, 2061406-02, 2061406-03, 2062801-01, 2062801-02, 2062801-03, 2062801-04, 2062801-05, 2062801-06, 2062801A01, 2062801A02, 2062801A03, 2062801A04, 2062801A05, 2062801A06, 2062801B01, 2062801B02... (Other models you can see in the webshop) | | |

sealing cords

round

1

| | | | |
|--------------------|--|-----------------|--------|
| Part No. | 693464 | Ref. No. | 211047 |
| description | sealing cord ø 10mm Qty supplied by meter | | |
| For models: | 2023201-01, 2023201-02, 2023201-03, 2023201A01, 2023202-01, 2023202-02, 2023202A01, 2023203-02, 2023203-03, 2023203-04, 2023203-05, 2023203-06, 2023203-07, 2023203A02, 2023203A03, 2023204-01, 2023204-02, 2023204A01, 2023205-02, 2023205-03, 2023205-04, 2023205-05, 2023205-06, 2023205-07, 2023205A02, 2023205A03, 2083201A01, 2083202A02, 2083202A03, 3023201-01, 3023201-02, 3023204-01, 3023204-02 | | |

1

| | | | |
|--------------------|--|-----------------|--------|
| Part No. | 693451 | Ref. No. | 211031 |
| description | sealing cord ø 8mm Qty supplied by meter | | |
| For models: | 2023501-03, 2023501-04, 2023501-05, 2023501A02, 2023502-02, 2023502-03, 2023502-04, 2023502A02, 2023503-03, 2023503-04, 2023503-05, 2023503-06, 2023503-07, 2023503-08, 2023503-09, 2023503-10, 2023503A04, 2023503A05, 2023503A06, 3023501-01, 3023501-02, 3023501-03, 3023501A01, 3023502-01, 3023502-02, 3023502-03, 3023502A01 | | |



shaft gaskets

miscellaneous



1

Part No. 691513 **Ref. No.** 211084

description shaft seal ID ø 16.5mm ED ø 29mm thickness 4.8mm

special gaskets

for combi-steamers



1

Part No. 692800 **Ref. No.** 211141

description gasket suitable for MKN combi-steamer L 82mm W 62mm mounting pos. burner thickness 1.5mm graphite Qty 1 pcs



1

Part No. 699362 **Ref. No.** 211079

description gasket suitable for MKN profile no to be sold in France for combi-steamer ED ø 58mm rubber DN 50mm



1

Part No. 699366 **Ref. No.** 211080

description gasket suitable for profile for combi-steamer ED ø 42mm ID ø 36mm rubber thickness 6.5mm



1

Part No. 699365 **Ref. No.** 211078

description gasket U-bend L 73mm W 73mm ID ø 60mm thickness 3mm

miscellaneous



1

Part No. 550289 **Ref. No.** 211003

description flat gasket

For models: 2020301-0, 2020301-00, 2020301-01, 2020301-02, 2020301A00, 2020301A01, 2020301A02, 2020301A03, 2020301B00, 2020301B01, 2020301C00, 2020301C01, 2020302-0, 2020302-00, 2020302-01, 2020302-02, 2020302-03, 2020302-04, 2020302-05, 2020302A00, 2020302A01, 2020302A02, 2020302A03, 2020302A04, 2020302A05, 2020302B00, 2020302B01, 2020302C00, 2020302C01, 2020307A00, 2020501-0, 2020501-00, 2020501-01, 2020501-02, 2020502-00, 2020503-0, 2020504-00, 2020505-00, 2020505-01, 2020505-02, 2020505-03, 2020506-01, 2020601-00, 2020601-01, 2021101-0, 2021101-00, 2021101A00, 2021102-0, 2021102-00, 2021103-0...(Other models you can see in the webshop)

springs

torsion springs



1

Part No. 699291 **Ref. No.** 216156

description torsion spring ø 24mm L2 69mm wire gauge ø 3mm L1 23mm L3 69mm for door handle

hose reels and spray guns

spray guns



1

Part No. 542800 **Ref. No.** 201147

description spray gun for appliances 1/2" ET L 120mm with backflow preventer type MKN



hose reels

appliance hose reels



1

| | | | |
|--------------------|--|-----------------|--------|
| Part No. | 542804 | Ref. No. | 204410 |
| description | hose reel without spray gun hose length 1.8m | | |

hoses

industrial hoses

nylon hoses



1

| | | | |
|--------------------|---|-----------------|--------|
| Part No. | 530566 | Ref. No. | 050016 |
| description | nylon hose ID ø 8mm ED ø 10mm L 5m thickness 1mm operating p. 10bar burst p. 50bar t.max. 100°C transparent | | |

fastening material

rivets/rivet nuts

blind rivet nuts hexagonal



1

| | | | |
|--------------------|---|-----------------|--------|
| Part No. | 551382 | Ref. No. | 208039 |
| description | rivet nut thread M8 DN 11mm L 16.4mm SS Qty 1 pcs | | |

screws

sheet metal screws



1

| | | | |
|--------------------|---|-----------------|--------|
| Part No. | 560102 | Ref. No. | 111202 |
| description | sheet metal screws ø 3.9mm L 9.5mm SS Qty 20 pcs DIN 7981/ISO 7049 head ø 7.5mm oval head | | |

countersunk screws



1

| | | | |
|--------------------|---|-----------------|--------|
| Part No. | 560263 | Ref. No. | 105470 |
| description | countersunk screw thread M4 L 25mm SS DIN 963/ISO 2009 Qty 20 pcs intake slotted head ø 7.5mm | | |



1

| | | | |
|--------------------|--|-----------------|--------|
| Part No. | 560425 | Ref. No. | 105466 |
| description | countersunk screw thread M4 L 13mm stainless steel DIN 965/ISO 7046 Qty 1 pcs head ø 7.5mm | | |

flat-headed bolts



1

| | | | |
|--------------------|---|-----------------|--------|
| Part No. | 560635 | Ref. No. | 105008 |
| description | flat-headed bolt thread M3 thread L 6mm with plain washer | | |



1

| | | | |
|--------------------|--|-----------------|--------|
| Part No. | 560626 | Ref. No. | 105001 |
| description | flat-headed bolt thread M4 thread L 8mm head ø 8mm head thickness 3mm torx | | |



1

| | | | |
|--------------------|---|-----------------|--------|
| Part No. | 511004 | Ref. No. | 105115 |
| description | flat-headed bolt thread M4 thread L 12mm SS DIN 84/ISO 1207 Qty 1 pcs intake slotted L 14.5mm | | |



1

| | | | |
|--------------------|--|-----------------|--------|
| Part No. | 560454 | Ref. No. | 105121 |
| description | flat-headed bolt thread M4 thread L 22mm SS DIN 84/ISO 1207 Qty 1 pcs intake slotted head ø 7mm head thickness 2.5mm | | |

raised countersunk head screws





1

| | | | |
|--------------------|--|-----------------|--------|
| Part No. | 560634 | Ref. No. | 105471 |
| description | raised countersunk head screw thread M4 thread L 40mm SS Qty 1 pcs intake slotted head ø 7.3mm | | |





hexagonal screws

| | | | |
|--|--|-----------------|--------|
|  <p>1</p> | | | |
| Part No. | 560311 | Ref. No. | 101451 |
| description | hexagonal screw thread M10 thread L 20mm SS WS 17 Qty 1 pcs DIN 933 / ISO 4017 | | |

| | | | |
|--|---|-----------------|--------|
|  <p>1</p> | | | |
| Part No. | 560081 | Ref. No. | 101412 |
| description | hexagonal screw thread M4 thread L 10mm SS WS 7 Qty 20 pcs DIN 933 / ISO 4017 | | |

| | | | |
|--|--|-----------------|--------|
|  <p>1</p> | | | |
| Part No. | 560080 | Ref. No. | 101127 |
| description | hexagonal screw thread M4 thread L 8mm SS WS 7 Qty 20 pcs DIN 933 / ISO 4017 | | |

| | | | |
|---|---|-----------------|--------|
|  <p>1</p> | | | |
| Part No. | 560083 | Ref. No. | 101125 |
| description | hexagonal screw thread M5 thread L 10mm SS WS 8 Qty 20 pcs DIN 933 / ISO 4017 | | |

| | | | |
|--|---|-----------------|--------|
|  <p>1</p> | | | |
| Part No. | 560084 | Ref. No. | 101403 |
| description | hexagonal screw thread M5 thread L 16mm SS WS 8 Qty 20 pcs DIN 933 / ISO 4017 | | |

| | | | |
|--|--|-----------------|--------|
|  <p>1</p> | | | |
| Part No. | 560086 | Ref. No. | 101405 |
| description | hexagonal screw thread M6 thread L 10mm SS WS 10 Qty 20 pcs DIN 933 / ISO 4017 | | |

| | | | |
|--|---|-----------------|--------|
|  <p>1</p> | | | |
| Part No. | 550682 | Ref. No. | 101435 |
| description | hexagonal screw thread M8 thread L 20mm SS WS 13 Qty 1 pcs DIN 933 / ISO 4017 | | |

cylinder head bolts

| | | | |
|---|--|-----------------|--------|
| <p>DIN 912/ISO 4762</p>  <p>1</p> | | | |
| Part No. | 560305 | Ref. No. | 102008 |
| description | cylinder head bolt thread M5 thread L 16mm WS 4 intake internal hexagon DIN 912/ISO 4762 | | |

| | | | |
|---|--|-----------------|--------|
|  <p>1</p> | | | |
| Part No. | 520455 | Ref. No. | 102050 |
| description | screw thread M8 thread L 20mm WS 6 SS Qty 1 pcs DIN 912/ISO 4762 | | |

side bolts

| | | | |
|---|---|-----------------|--------|
|  <p>1</p> | | | |
| Part No. | 560051 | Ref. No. | 118005 |
| description | side bolts thread M4 L 16mm SS Qty 20 pcs intake slotted head ø 10mm | | |
| For models: | 2020301-0, 2020301-00, 2020301-01, 2020301-02, 2020301A00, 2020301A01, 2020301A02, 2020301A03, 2020301B00, 2020301B01, 2020301C00, 2020301C01, 2020302-0, 2020302-00, 2020302-01, 2020302-02, 2020302-03, 2020302-04, 2020302-05, 2020302A00, 2020302A01, 2020302A02, 2020302A03, 2020302A04, 2020302A05, 2020302B00, 2020302B01, 2020302C00, 2020302C01, 2020303-02, 2020303-03, 2020303-04, 2020303A00, 2020307A00, 2020501-0, 2020501-00, 2020501-01, 2020501-02, 2020502-00, 2020503-0, 2020504-00, 2020505-00, 2020505-01, 2020505-02, 2020505-03, 2020506-01, 2020601-00, 2020601-01, 2021101-0, 2021101-00... (Other models you can see in the webshop) | | |

| | | | |
|---|--|-----------------|--------|
|  <p>1</p> | | | |
| Part No. | 560053 | Ref. No. | 118009 |
| description | side bolts thread M5 L 16mm SS Qty 20 pcs intake slotted head ø 12.5mm | | |

grub screws

| | | | |
|--|---|-----------------|--------|
| <p>miscellaneous</p>  <p>1</p> | | | |
| Part No. | 560306 | Ref. No. | 110124 |
| description | grub screw thread M6 L 10mm DIN 915 intake internal hexagon Qty 1 pcs | | |



nuts

hexagonal nuts

DIN 934 / ISO 4032/8673



1

| | | | |
|--------------------|---|-----------------|--------|
| Part No. | 560223 | Ref. No. | 113081 |
| description | hexagonal nut thread M3 H 2.4mm WS 5.5 SS DIN/ISO DIN 934 / ISO 4032/8673 Qty 1 pcs | | |



1

| | | | |
|--------------------|---|-----------------|--------|
| Part No. | 560340 | Ref. No. | 113082 |
| description | hexagonal nut thread M4 H 3.2mm WS 7 SS DIN/ISO DIN 934 / ISO 4032/8673 Qty 1 pcs | | |



1

| | | | |
|--------------------|---|-----------------|------------------|
| Part No. | 560129 | Ref. No. | 113087 113088 |
| description | hexagonal nut thread M5 H 4mm WS 8 SS DIN/ISO DIN 934 / ISO 4032/8673 Qty 1 pcs | | |



1

| | | | |
|--------------------|--|-----------------|--------|
| Part No. | 511212 | Ref. No. | 113091 |
| description | hexagonal nut thread M6 H 5mm WS 10 SS DIN/ISO DIN 934 / ISO 4032/8673 Qty 1 pcs | | |



1

| | | | |
|--------------------|---|-----------------|--------|
| Part No. | 560197 | Ref. No. | 113096 |
| description | nut thread M10 H 8mm WS 17 SS DIN/ISO DIN 934 / ISO 4032/8673 Qty 1 pcs | | |



1

| | | | |
|--------------------|--|-----------------|--------|
| Part No. | 517174 | Ref. No. | 113092 |
| description | nut thread M8 H 6.5mm WS 13 SS DIN/ISO DIN 934 / ISO 4032/8673 Qty 1 pcs | | |

DIN 985



1

| | | | |
|--------------------|--|-----------------|--------|
| Part No. | 560227 | Ref. No. | 116041 |
| description | hexagonal nut thread M3 H 4mm SS WS 5.5 Qty 1 pcs self-locking | | |



1

| | | | |
|--------------------|---|-----------------|--------|
| Part No. | 560140 | Ref. No. | 113014 |
| description | hexagonal nut thread M4 H 4.8mm SS WS 7 Qty 20 pcs DIN/ISO DIN 985 self-locking | | |



1

| | | | |
|--------------------|---|-----------------|--------|
| Part No. | 560141 | Ref. No. | 116061 |
| description | hexagonal nut thread M5 H 5.4mm SS WS 8 Qty 20 pcs DIN/ISO DIN 985 self-locking | | |



1

| | | | |
|--------------------|--|-----------------|--------|
| Part No. | 560142 | Ref. No. | 116063 |
| description | hexagonal nut thread M6 H 6mm SS WS 10 Qty 20 pcs DIN/ISO DIN 985 self-locking | | |



1

| | | | |
|--------------------|--|-----------------|--------|
| Part No. | 560143 | Ref. No. | 121124 |
| description | hexagonal nut thread M8 H 8.5mm SS WS 13 Qty 20 pcs DIN/ISO DIN 985 self-locking | | |

miscellaneous



1

| | | | |
|--------------------|-------------------------|-----------------|--------|
| Part No. | 560548 | Ref. No. | 208025 |
| description | nut thread M4 Qty 1 pcs | | |

| | | | |
|--------------------|--|--|--|
| For models: | 2020301-00, 2020301-01, 2020301-02, 2020301A00, 2020301A01, 2020301A02, 2020301A03, 2020301B00, 2020301B01, 2020301C00, 2020301C01, 2020302-00, 2020302-01, 2020302-02, 2020302-03, 2020302-04, 2020302-05, 2020302A00, 2020302A01, 2020302A02, 2020302A03, 2020302A04, 2020302A05, 2020302B00, 2020302B01, 2020302C00, 2020302C01, 2020303-00, 2020303-01, 2020303-02, 2020303-03, 2020303-04, 2020303A00, 2020307A00, 2020501-01, 2020501-02, 2020502-00, 2020504-00, 2020505-00, 2020505-01, 2020505-02, 2020505-03, 2020506-01, 2020601-00, 2020601-01, 2021101-00, 2021101A00, 2021102-00, 2021103-00, 2021104-00... (Other models you can see in the webshop) | | |
|--------------------|--|--|--|



washers

spring rings



1

| | | | |
|--------------------|--|-----------------|--------|
| Part No. | 560122 | Ref. No. | 121032 |
| description | lock washer ID ø 5.2mm ED ø 9mm SS DIN127 Qty 20 pcs for thread M5 | | |

washers

DIN 125A



1

| | | | |
|--------------------|---|-----------------|--------|
| Part No. | 560110 | Ref. No. | 120005 |
| description | plain washer ID ø 3.2mm ED ø 7mm thickness 0.5mm SS Qty 20 pcs DIN 125A for thread M3 | | |



1

| | | | |
|--------------------|---|-----------------|--------|
| Part No. | 560111 | Ref. No. | 120017 |
| description | plain washer ID ø 4.3mm ED ø 9mm thickness 0.8mm SS Qty 20 pcs DIN 125A for thread M4 | | |



1

| | | | |
|--------------------|--|-----------------|--------|
| Part No. | 560112 | Ref. No. | 120022 |
| description | plain washer ID ø 5.3mm ED ø 10mm thickness 1mm SS Qty 20 pcs DIN 125A for thread M5 | | |



1

| | | | |
|--------------------|---|-----------------|--------|
| Part No. | 560333 | Ref. No. | 120027 |
| description | plain washer ID ø 6.4mm ED ø 12mm thickness 1.6mm SS Qty 1 pcs DIN 125A for thread M6 | | |



1

| | | | |
|--------------------|---|-----------------|--------|
| Part No. | 560645 | Ref. No. | 120008 |
| description | plain washer ID ø 7.4mm ED ø 14mm thickness 1.6mm SS Qty 1 pcs DIN 125A | | |



1

| | | | |
|--------------------|--|-----------------|--------|
| Part No. | 560114 | Ref. No. | 120108 |
| description | plain washer ID ø 8.4mm ED ø 16mm thickness 1.6mm SS Qty 20 pcs DIN 125A for thread M8 | | |

DIN 9021



1

| | | | |
|--------------------|---|-----------------|--------|
| Part No. | 560303 | Ref. No. | 120030 |
| description | plain washer ID ø 6.4mm ED ø 18mm Qty 1 pcs for thread M6 | | |
| For models: | | | |

nylon



1

| | | | |
|--------------------|--|-----------------|--------|
| Part No. | 560646 | Ref. No. | 120007 |
| description | plain washer ID ø 12.5mm ED ø 28mm thickness 3mm nylon Qty 1 pcs | | |

tooth lock washers

DIN 6798A



1

| | | | |
|--------------------|---|-----------------|--------|
| Part No. | 560125 | Ref. No. | 121023 |
| description | tooth lock washer ID ø 4.2mm ED ø 8mm SS DIN/ISO DIN 6798A Qty 20 pcs for thread M4 | | |



consumables

cleaning agents

combi-steamer detergents/descalers

Notice: Articles labelled 'DANGEROUS GOODS' are delivered by road through a forwarder for reasons of safety and are charged separately!



1

| | | | |
|--------------------|--|-----------------|---------------------|
| Part No. | 802061 | Ref. No. | 303324 40-100575 |
| description | detergent for combi-steamer MKN WaveClean detergent/rinse aid Qty 10 pcs | | |
| description | MKN WaveClean - detergent - box of 10 cartridges Combination product for cleaning and descaling of combi steamers with WaveClean® Innovative 2-in-1 cartridge with cleaner and rinse aid. Easy handling with no direct contact to active agents. Cleans MKN combi steamers reliably, economically and hygienically. Start the WaveClean® cleaning program, unscrew the 2-in-1 cartridge cap and insert the cartridge into the holder when prompted to do so. After the cleaning process remove the cartridge before starting the machine. Rinse off any residue with plenty of water. For commercial use only. | | |

fuses

fine fuses

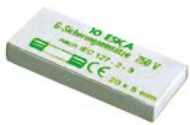

1

| | | | |
|--------------------|--|-----------------|--------|
| Part No. | 358601 | Ref. No. | 203722 |
| description | fine fuse size ø5x20mm 1.25A slow-acting rated 250V Qty 10 pcs | | |



1

| | | | |
|--------------------|--|-----------------|--------|
| Part No. | 358608 | Ref. No. | 203996 |
| description | fine fuse size ø5x20mm 10A slow-acting rated 250V Qty 10 pcs | | |



1

| | | | |
|--------------------|---|-----------------|--------|
| Part No. | 358607 | Ref. No. | 203473 |
| description | fine fuse size ø5x20mm 6.3A slow-acting rated 250V Qty 10 pcs | | |

screw locks

D0-system (NEOZED)



1

| | | | |
|--------------------|---|-----------------|--------|
| Part No. | 358045 | Ref. No. | 203739 |
| description | fuse size D02 35A rated 250/400V E18 ø 15mm L 36mm Qty 10 pcs | | |

GASTROPARTS.COM



© 2020 Gastroparts Sp. J. All rights reserved.